



# Bulgins Ethos

Borne out of their experience in developing electronic components for the [world-renowned connectivity](#) and switching brands [Bulgin](#) and Arcoelectric, our teams of product development engineers based at the Connectivity Lab in Cambridge relish the challenge of delivering complex and demanding [custom solutions](#).

Working in close collaboration with you, we identify opportunities, mitigate risks and plan how to exploit new and emerging technologies, creating category-driving innovations that deliver on highly demanding projects.

## [Pushing the boundaries of new product development.](#)

At the Connectivity Lab, we offer our customers a high quality, 'one stop shop' engineering resource, using our technical expertise and extensive knowledge across a range of engineering disciplines to provide human-centered design, as well as turnkey project management capabilities. Liaising directly with our manufacturing plants, the Connectivity Lab ensures that no stone is unturned in getting your ideas off the page and progressing your prototype to full-scale manufacturing to meet the demands of your customers. This simplifies the supply chain and the manufacturing process, reduces production costs and accelerates time to market.

## [Excellence and experience](#)

Having access to the right expertise, at the right time – whether it is for an individual phase of the development project or the entire production process – is a vital part of the transition from concept to finished product. At Elektron, we foster an entrepreneurial approach, equipping our engineers with state-of-the-art facilities and cutting-edge design tools, including: analytical modelling computer-aided design rapid prototyping printed circuit board manufacture testing and quality assurance

## [Celebrating individuality!](#)

All of our customers are individuals and so are their projects. With diverse R&D skills covering every aspect of engineering and a quest to bring high-level innovation to the table, our bespoke services are uniquely tailored to customers' individual needs, giving you the very best results when we take an original concept from design through to manufacture.

We pay close attention to every element of the product development and manufacturing process and have designed the StageGate® Process, our own method to control and document every step. Our service offers ISO 9001 accreditation for document control so that you can reap the benefits of our carefully controlled protocols, whether for just one aspect of a project or the entire development process.

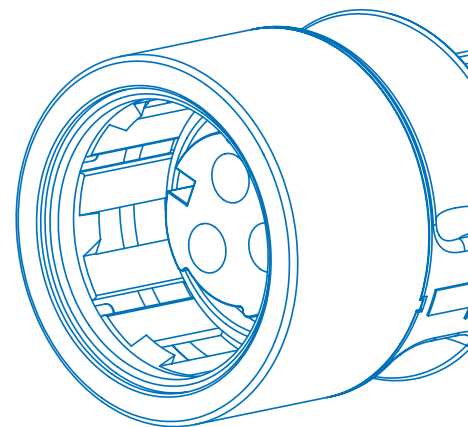

[Identify](#) - [Design](#) - [Build](#) - [Validate](#) - [Sustain](#)

# Our Skills

Whatever your engineering requirement is, we have the knowledge and capability in-house to bring your projects to reality.

## Mechanical

- in-house 3D modelling
- finite element analysis
- rapid prototyping
- 3D rendered models

## Electronics

- in-house modelling
- simulation
- rapid prototyping
- optimized printed circuit board layouts
- human-centered design

## Assembly

- cable to connector complete assemblies
- overmoulding tools for all our connectors
- enclosures and complete panel assembly
- turnkey solutions for nished article or sub-assembly parts

## Software

- agile software development
- continuous integration
- source code management
- straightforward graphical user interfaces
- improved usability

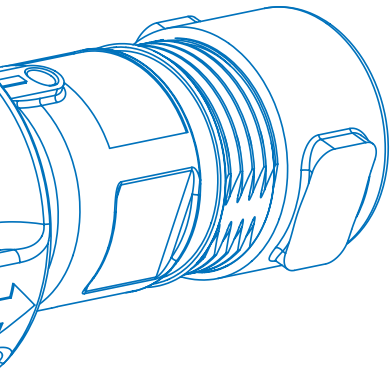

# Approvals

Good design, high quality and maximum value have formed an integral part of the Bulgin philosophy.

We maintain a documented quality plan specifying process and product goals and are approved by BSI to ISO9001.

Investment in new plant and equipment makes an important contribution to continuous quality improvements. The risk of errors in the transition from design to manufacture is greatly reduced by the digital data flows from our CAD system, and our sophisticated automatic manufacturing equipment which can form and assemble components to consistently high quality standards.

All new products are extensively pre-production tested, in our dedicated electrical and mechanical test facility, which also conducts regular checks during manufacture.

The numerous international safety approvals gained are testimony in themselves to Bulgin's ongoing commitment to quality and the world wide market place.

These European Directives introduced environmental responsibilities for electrical and electronics equipment manufacturers. The RoHS (Restriction of use of certain Hazardous Substances) regulation (Directive 2002/95/EC) came into force July 2006. The WEEE (Waste Electrical and Electronic Equipment) regulation (Directive 2002/96/EC), came into force January 2007.

The RoHS directive effectively bans the use of certain chemicals, these are defined as:

- Lead
- Cadmium
- Mercury
- Hexavalent Chromium
- Polybrominated Biphenyl (PBB) - flame retardant
- Polybrominated Diphenyl Ether (PBDE) - flame retardant (including Deca BDE)

Action has been taken to ensure all standard products meet the requirements of this directive. All packing carries RoHS compliance information as conformation.

\*Our IP ratings are internally tested to EN 60529. IP68 rated products have undergone immersion testing in water at a depth of 10M for a period of 2 weeks unless otherwise stated.



# Our Offices

Bulgin has a [global presence](#), with regional offices located in the [UK](#), [US](#) and [China](#). Our reach is also through an [extensive distribution network](#) which covers over [200 countries worldwide](#).



## Contact Us

### Europe

Elektron Technology,  
Broers Building,  
JJ Thomson Avenue, Cambridge,  
CB3 0FA,

Tel: +44 (0)1223 371 000  
Email: [info@bulgin.com](mailto:info@bulgin.com)

### The Americas

Elektron Technology  
11849 Telegraph Road  
Santa Fe Springs  
CA 90670 USA

Tel: +1 760-343-3650  
Email: [info@bulgin.com](mailto:info@bulgin.com)

### China and Asia

Elektron Technology Pte Ltd  
3 Temasek Avenue  
Centennial Tower  
Level 34, Singapore 039190

Tel: +65 6549 7161  
Email: [info@bulgin.com](mailto:info@bulgin.com)

# Contents

<b>Circular Power Connectors</b>	<b>08</b>	<b>Fuseholders</b>	<b>300</b>
Explora	09-14	Panel Mounting	302-308
900 Series Buccaneer	15-10	IP68 Panel Mounting	309
Standard Buccaneer	21-29	IP66 Panel Mounting	310
Mini Buccaneer	30-33	PC Mounting	311-312
400 Series Buccaneer	34-39	Base Mounting	313
4000 Series Buccaneer	40-45	In-line	314-315
6000 Series Buccaneer	46-53		
7000 Series Buccaneer	54-61		
<b>Circular Data Connectors</b>	<b>62</b>	<b>Indicators</b>	<b>316</b>
Standard Buccaneer - Ethernet	63-68	Vandal Resistant LED	317-318
Standard Buccaneer - USB	69-74	LED Bezel	319-323
400 Series - Mini USB Buccaneer	75-79	Indicator Lights	324-330
400 Series - SMB Buccaneer	80-82	Low Voltage Lampholders	331-332
400 Series - Wireless Buccaneer	83-89	LED Lampholders	333-334
4000 Series - Micro USB	90-92	Indicator Lights IP67	335
6000 Series Buccaneer - USB	93-98		
6000 Series Buccaneer - Ethernet	99-103		
<b>Circular Automation Connectors</b>	<b>104</b>		
M5 Series	106-110		
M8 Series	111-119		
M12 Series	120-131		
M16 Series	132-135		
M23 Series	136-138		
M-Series Distribution Unit	139-142		
<b>Switches</b>	<b>143</b>		
Vandal Resistant	144-162		
Push Button	163-173		
Voltage Selectors	174		
Piezo	175-180		
12mm Switches	181-186		
Rocker Switches	187-213		
Toggle Switches	214-218		
Refrigerator Switches	219-224		
Slide Switches	225-229		
<b>Battery Holders</b>	<b>230</b>		
IP67 Sealed	232		
Panel Mounting	233-234		
PCB/Base Mounting	235-236		
<b>IEC</b>	<b>237</b>		
Inlets and Outlet Connectors	238-262		
Distribution Units	263-267		
Polysnap Connection Modules	288-290		
EMI Mains Filters	291-299		





# A full range of IP66, IP68 and IP69K rated environmentally sealed circular connectors designed to provide secure and safe connections in harsh or hostile conditions.

The Power Buccaneer range consist of the miniature 400, Mini, Standard, 900, 7000 and 6000 Series. Screw terminations ensure simple 'field' connection, while crimp terminations fulfil the requirement for fast effective volume connections.

Each range has flex cable connector, in-line flex cable connector and panel mounting connector options. Over molded versions of the 400 series and Standard Buccaneer provide safe, secure and tamperproof cable termination.

With a wide choice of alternatives from 2 to 32 poles, BNC connections and screw, solder or crimp terminations, the Buccaneer range provides the answer to many design problems.

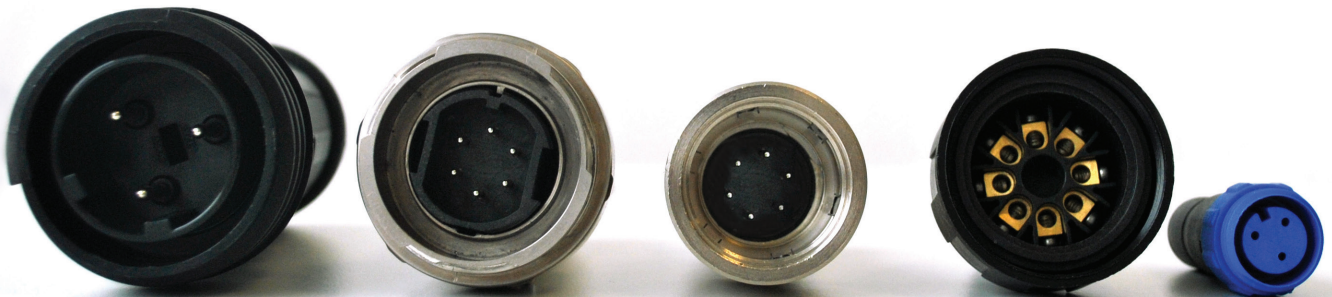

Explora Series	09-14
900 Series Buccaneer	15-20
Standard Buccaneer	21-29
Mini Buccaneer	30-33
400 Series Buccaneer	34-39
4000 Series Buccaneer	40-45
6000 Series Buccaneer	46-53
7000 Series Buccaneer	54-61



The EXPlora range is most suited to manufacturers of ancillary electrical equipment such as motors, pumps, lighting equipment, process and control gear for use in factories and plant where hazardous or explosive atmospheres can be caused by flammable gases, mists or vapours or by combustible dusts.



Independently tested for compliance to ATEX standards for use in Zone 2 and Zone 22 environments, the new EXP series is manufactured from a tough, high grade UL94V-0 rated Polyester material and provides environmental sealing to IP68. The ATEX coding is: Ex II 3 GD and the certificated no: Baseefa09ATEX0232X.

EXPlora is rated up to 18A, 600Vac/dc for 2, 3, 4 and 5 poles, 16A, 430Vac/dc for 7 pole and 10A, 250Vac/dc for 10 poles. The 3, 4, 5 and 7 pole versions have leading earth contacts making them suitable for single or three phase applications.



- ⊞ ATEX approval for Zone 2 and Zone 22 applications
- ⊞ Independently tested
- ⊞ ATEX Coding:  Ex II 3 GD
- ⊞ ATEX Classification: Ex nA IIC T6 Gc  
Ex tc IIIC T85°C Dc
- ⊞ ATEX Certificate No: Baseefa09ATEX0232X
- ⊞ IP68 rating tested at 1.054kg/sq cm (15lb/sq in)
- ⊞ 10m depth for 2 weeks
- ⊞ Up to 18A, 600V ac/dc rating
- ⊞ 2, 3, 4, 5, 7 and 10 pole
- ⊞ Leading earth contact for 3, 4, 5 & 7 pole versions
- ⊞ Trailing Neutral on 5 pole
- ⊞ Plug or socket connection in each body style
- ⊞ Water and dustproof to IP68 when mated
- ⊞ 'Scoop proof' contacts
- ⊞ Field termination - screw terminations
- ⊞ Positive locating keyways - cannot be mis-connected
- ⊞ Sealing caps available to maintain IP68 rating of unmated connectors
- ⊞ Compact design
- ⊞ Easy assembly - no special tools required
- ⊞ Single or 3 phase applications
- ⊞ Cost effective solution
- ⊞ Cable acceptance from 7 to 22mm O/D
- ⊞ Two cable connector versions for 15mm and 22mm (maximum) cable diameters
- ⊞ Separate strain relief on large cable version

Flex Cable Connector



EXP-0911

- Mates with in-line flex or panel mounting versions
- Positive, fast acting locking ring - can be turned with a gloved hand
- Plug or socket versions
- EXP-0 Series 13-15mm cable dia. acceptance as standard, 7-13mm with additional gland pack

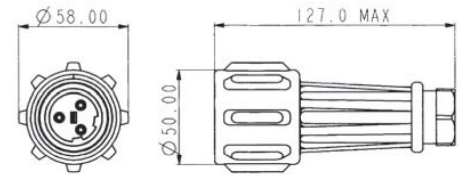

Flex Cable Connector



EXP-A911

- EXP-A Series 20-22mm cable dia. Acceptance as standard, 14-20mm with additional gland pack
- Strain Relief Clamp

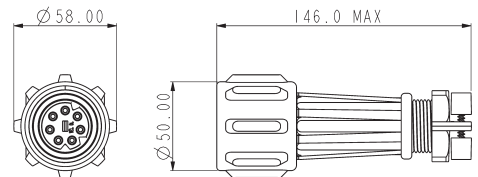

Standard Cable	Large Cable	Description	Standard Cable	Large Cable	Description
EXP-0911/02/P	EXP-A911/02/P	2 pole Plug	EXP-0911/02/S	EXP-A911/02/S	2 pole Socket
EXP-0911/03/P	EXP-A911/03/P	3 pole Plug	EXP-0911/03/S	EXP-A911/03/S	3 pole Socket
EXP-0911/04/P	EXP-A911/04/P	4 pole Plug	EXP-0911/04/S	EXP-A911/04/S	4 pole Socket
EXP-0911/05/P	EXP-A911/05/P	5 pole Plug	EXP-0911/05/S	EXP-A911/05/S	5 pole Socket
EXP-0911/07/P	EXP-A911/07/P	7 pole Plug	EXP-0911/07/S	EXP-A911/07/S	7 pole Socket
EXP-0911/10/P	EXP-A911/10/P	10 pole Plug	EXP-0911/07/S	EXP-A911/10/S	10 pole Socket

In-Line Flex Cable Connector



EXP-0921

- Mates with either EXP-0911 or EXP-A911 connectors
- Plug or socket versions
- EXP-0 Series 13-15mm cable dia. acceptance as standard, 7-13mm with additional gland pack

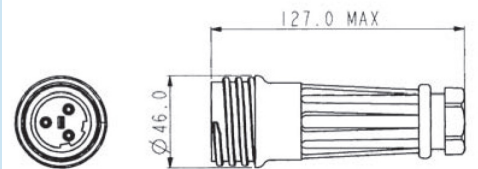

In-Line Flex Cable Connector



EXP-A921

- EXP-A Series 20-22mm cable dia. acceptance as standard, 14-20mm with additional gland pack
- Strain Relief Clamp

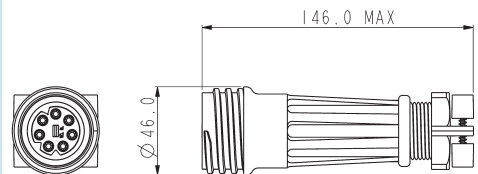

Standard Cable	Large Cable	Description	Standard Cable	Large Cable	Description
EXP-0921/02/P	EXP-A921/02/P	2 pole Plug	EXP-0921/02/S	EXP-A921/02/S	2 pole Socket
EXP-0921/03/P	EXP-A921/03/P	3 pole Plug	EXP-0921/03/S	EXP-A921/03/S	3 pole Socket
EXP-0921/04/P	EXP-A921/04/P	4 pole Plug	EXP-0921/04/S	EXP-A921/04/S	4 pole Socket
EXP-0921/05/P	EXP-A921/05/P	5 pole Plug	EXP-0921/05/S	EXP-A921/05/S	5 pole Socket
EXP-0921/07/P	EXP-A921/07/P	7 pole Plug	EXP-0921/07/S	EXP-A921/07/S	7 pole Socket
EXP-0921/10/P	EXP-A921/10/P	10 pole Plug	EXP-0921/07/S	EXP-A921/10/S	10 pole Socket

Panel Mounting Connector



EXP-0931

- Mates with EXP-0911 and EXP-A911 connectors
- Single hole fixing
- Anti-rotation key
- High grade sealing gasket
- 3-7mm panel thickness

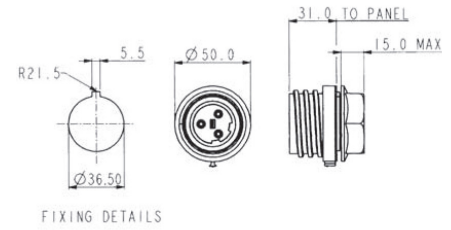

**Panel Mounting**

EXP-0931/02/P	2 pole Plug
EXP-0931/03/P	3 pole Plug
EXP-0931/04/P	4 pole Plug
EXP-0931/05/P	5 pole Plug
EXP-0931/07/P	7 pole Plug
EXP-0931/10/P	10 pole Plug

EXP-0931/02/S	2 pole Socket
EXP-0931/03/S	3 pole Socket
EXP-0931/04/S	4 pole Socket
EXP-0931/05/S	5 pole Socket
EXP-0931/07/S	7 pole Socket
EXP-0931/10/S	10 pole Socket

Flange Mounting Connector



EXP-0941

- Mates with EXP-0911 and EXP-A911 connectors
- Supplied with high grade sealing gasket
- Supplied with sealing grommets for panel fixing screws (M6 thread recommended)

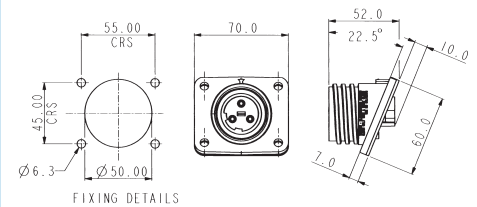

**Panel Mounting**

EXP-0941/02/P	2 pole Plug
EXP-0941/03/P	3 pole Plug
EXP-0941/04/P	4 pole Plug
EXP-0941/05/P	5 pole Plug
EXP-0941/07/P	7 pole Plug
EXP-0941/10/P	10 pole Plug

EXP-0941/02/S	2 pole Socket
EXP-0941/03/S	3 pole Socket
EXP-0941/04/S	4 pole Socket
EXP-0941/05/S	5 pole Socket
EXP-0941/07/S	7 pole Socket
EXP-0941/10/S	10 pole Socket

Accessories



EXP-0990, EXP-0991, EXP-0992

- Heavy duty sealing caps to maintain IP68 rating of unmated connectors, with stainless steel straps

**Sealing Caps**

EXP-0990	Heavy duty sealing cap for use with EXP-0911/xx/x and EXP-A911/xx/x
EXP-0991	Heavy duty sealing cap for use with EXP-0921/xx/x and EXP-A921/xx/x
EXP-0992	Heavy duty sealing cap for use with EXP-0931 and EXP-0941

Cable Glands



PX0980, PXA980

- Packs of 3 additional pairs Cable Glands for 900 Series Flex Cable Connectors

**Gland Packs**

EXP-0980	Pack of 3 additional cable glands for EXP-0911 and EXP-0921 to suit cable sizes; 11-13mm, 9-11 and 7-9mm dia.
EXP-A980	Pack of 3 additional cable glands for EXP-A911 and EXP-A921 to suit cable sizes; 18-20mm, 16-18 and 14-16mm dia.

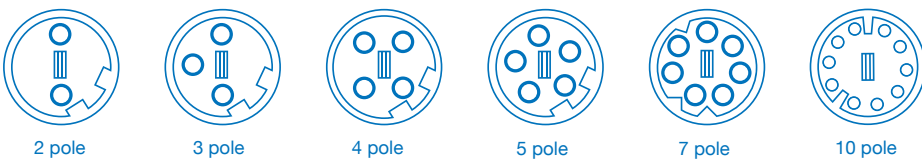
EXP X9	X	X	/	XX	/	X	/	X
<b>Series Designation</b> 09 = Standard Cable Accommodation (7-13mm)  A9 = Large Cable Accommodation (14-22mm)	<b>Body Styles</b> 1 = Flex, 2 = Flex In-line, 3 = Panel, 4 = Flange Panel	<b>Contact Termination</b> 1 = Screw Terminal		<b>Number Contacts</b> 02 = 2 pole 03 = 3 pole 04 = 4 pole 05 = 5 pole 07 = 7 pole 10 = 10 pole		<b>Contact Type</b> P = Plug, S = Socket		<b>Cable Acceptance</b> <b>EXP-0 version:</b> Blank = 13-15mm Yellow cable gland (std)  3 = 11-13mm Black cable gland  2 = 9-11mm White cable gland  1 = 7-9mm Dark Grey cable gland  <b>EXP-A version:</b> Blank = 20-22mm Yellow cable gland (std)  9 = 18-20mm Black cable gland  8 = 16-18mm White cable gland  7 = 14-16mm Dark Grey cable gland
<b>Example:</b> EXP-0911/07/P/3 = Flex cable connector with standard cable accommodation body, seven pin contacts, with gland to suit 11-13mm cable.								
<b>Contact Layout</b>								
								
<b>Overall dimensions of connectors when mated together:</b>								
EXP-0911 + EXP-0921		230 mm max.	EXP-A911 + EXP-A931		175 mm max. (to panel)			
EXP-A911 + EXP-A921		270 mm max.	EXP-0911 + EXP-0941		145 mm max. (to panel, mid point on flange)			
EXP-0911 + EXP-0931		135 mm max. (to panel)	EXP-A911 + EXP-A941		174 mm max. (to panel, mid point on flange)			

EXPlora  
**EXP Series EXPlora - Hazardous Area Connector**

Specifications



**Electrical:**

No Poles:	2, 3, 4, 5    7    10
Current Rating:	18A    16A    10A
Voltage Rating:	600Vac/dc 430Vac/dc 250Vac/dc
Contact Resistance:	<10mΩ (initial)
Insulation Resistance:	>10 <sup>6</sup> MΩ (@ 500V dc)
Dielectric strength:	2.2kV ac min
AC Breakdown voltage:	6kV
Ambient Temperature Range:	-20°C to +55°C
Standards:	ATEX Zone 2 and Zone 22 IEC60079-0:2007 IEC60079-15:2005
ATEX Coding:	Ⓔ II 3 GD
ATEX Certificate No:	Baseefa09ATEX0232X
ATEX Classification:	Ex nA IIC T6 Gc Ex tc IIIC T85°C Dc

**Materials:**

Body Mouldings:	Polyester
Cap Mouldings:	Polycarbonate
Flammability Rating:	UL94V-0
UV Resistance:	To EN50021:1999
Contacts:	Machined Solid Brass, Nickel plated
O Rings:	Nitrile Panel
Sealing Gasket:	Silicone Rubber
<b>RoHS</b>	Compliant

**Mechanical:**

Sealing:	IP68, EN60529:2001 tested @ 1.054kg/sq.cm. (15lb/sq.in.) 10m depth for 2 weeks
Cable Acceptance:	EXP-0911 - EXP-0921 13 - 15mm O/D standard, 7-13mm with gland pack EXP-A911 - EXP-A921 20 - 22mm O/D standard, 14 - 20mm with gland pack
Contact Accommodation:	2-7 pole - 2.5 to 4mm <sup>2</sup> (13 to 10AWG) conductor, single or multi stranded 10 pole - 0.75 to 2mm <sup>2</sup> (14 to 18AWG) conductor, single or multi stranded
Termination:	Axial screw terminals 22mm dia, 150N 15mm dia, 150N 7mm dia, 80N
Cable Retention force:	
Gland Nut Torques:	
EXP-0 range	3.16Nm (28lbf/in)
13-15mm (Yellow - std.)	3.16Nm (28lbf/in)
11-13mm (black)	3.16Nm (28lbf/in)
9-11mm (white)	3.16Nm (28lbf/in)
7-9mm (dark grey)	
EXP-A range	
20-22mm (Yellow - std.)	3.16Nm (28lbf/in)
18-20mm (black)	3.16Nm (28lbf/in)
16-18mm (white)	3.16Nm (28lbf/in)
14-16mm (dark grey)	3.16Nm (28lbf/in)
Tightening Torques:	
Panel mount nut	2.25 Nm
Flange & Bulkhead fixing screws	0.9 Nm
Rear thread EXP-0931 series	M36 x 2-6g



- ⊕ IP68 rating tested at 1.054kg/sq cm (15lb/sq in) 10m depth for 2 weeks
- ⊕ IP69K, Tested in accordance with DIN 40050/Part 9 IP6k9k
- ⊕ 32A, 600V ac/dc rating
- ⊕ 2, 3, 4, 5, 7 and 10 pole
- ⊕ Plug or socket connection in each body style
- ⊕ Water and dustproof to IP68 when mated
- ⊕ 'Scoop proof' contacts
- ⊕ Field termination - screw terminations
- ⊕ Positive locating keyways - cannot be mis-connected
- ⊕ Sealing caps available to maintain IP68 rating of unmated connectors
- ⊕ Leading earth contact for 3, 4, 5 and 7 pole versions
- ⊕ EN60068-2-52 Test Kb Salt Mist (Cyclic) Marine Severity Level 1
- ⊕ Trailing Neutral on 5 pole
- ⊕ Compact design
- ⊕ Easy assembly - no special tools required
- ⊕ Single or 3 phase applications
- ⊕ Bulkhead moulding available for use with flange mounting body for 45° or 90° mounting (order each separately)
- ⊕ Cost effective solution
- ⊕ Cable accommodation 7-22mm O/D
- ⊕ Two cable connector versions for 15mm and 22mm (maximum) cable diameters
- ⊕ Separate strain relief on large cable version
- ⊕ CCC, UL, CSA and VDE approvals

Flex Cable Connector



PX0911

Flex Cable Connector



PXA911

- Mates with in-line flex or panel mounting versions
- Positive, fast acting locking ring - can be turned with a gloved hand
- Plug or socket versions
- PX0 Series 13-15mm cable dia. as standard, 7-13mm with additional gland pack
- PXA Series 20-22mm cable dia. as standard, 14-20mm with additional gland pack
- Strain Relief Clamp

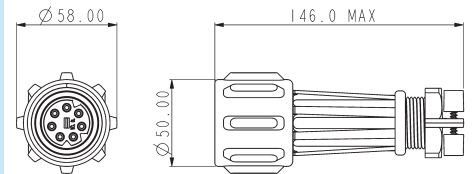
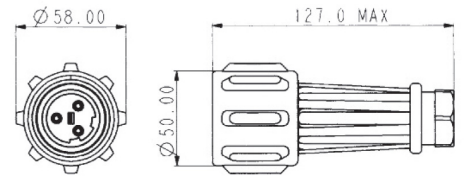

Standard Cable	Large Cable	Description	Standard Cable	Large Cable	Description
PX0911/02/P	PXA911/02/P	2 pole Plug	PX0911/02/S	PXA911/02/S	2 pole Socket
PX0911/03/P	PXA911/03/P	3 pole Plug	PX0911/03/S	PXA911/03/S	3 pole Socket
PX0911/04/P	PXA911/04/P	4 pole Plug	PX0911/04/S	PXA911/04/S	4 pole Socket
PX0911/05/P	PXA911/05/P	5 pole Plug	PX0911/05/S	PXA911/05/S	5 pole Socket
PX0911/07/P	PXA911/07/P	7 pole Plug	PX0911/07/S	PXA911/07/S	7 pole Socket
PX0911/10/P	PXA911/10/P	10 pole Plug	PX0911/10/S	PXA911/10/S	10 pole Socket

In-Line Flex Cable Connector



PX0921

In-Line Flex Cable Connector



PXA921

- Mates with either PX0911 or PXA911 connectors
- Plug or socket versions
- PX0 Series 13-15mm cable dia. as standard, 7-13mm with additional gland pack
- PXA Series 20-22mm cable dia. as standard, 14-20mm with additional gland pack
- Strain Relief Clamp

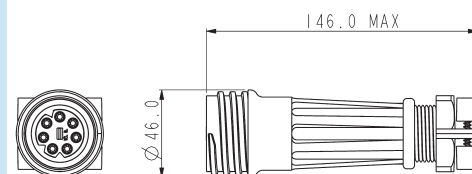
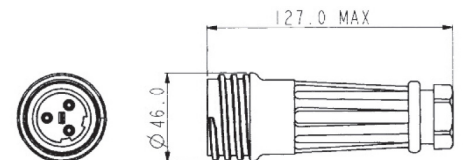

Standard Cable	Large Cable	Description	Standard Cable	Large Cable	Description
PX0921/02/P	PXA921/02/P	2 pole Plug	PX0921/02/S	PXA921/02/S	2 pole Socket
PX0921/03/P	PXA921/03/P	3 pole Plug	PX0921/03/S	PXA921/03/S	3 pole Socket
PX0921/04/P	PXA921/04/P	4 pole Plug	PX0921/04/S	PXA921/04/S	4 pole Socket
PX0921/05/P	PXA921/05/P	5 pole Plug	PX0921/05/S	PXA921/05/S	5 pole Socket
PX0921/07/P	PXA921/07/P	7 pole Plug	PX0921/07/S	PXA921/07/S	7 pole Socket
PX0921/10/P	PXA921/10/P	10 pole Plug	PX0921/10/S	PXA921/10/S	10 pole Socket



Panel Mounted Connector



PX0931

- Mates with PX0911 and PXA911 connectors
- Single hole fixing
- Anti-rotation key
- High grade sealing gasket
- 3-7mm panel thickness

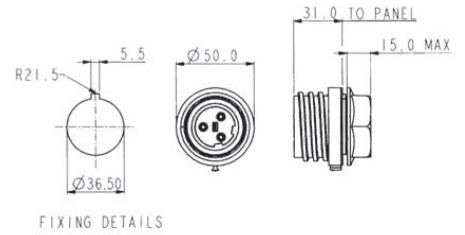

**Panel Mounting**

PX0931/02/P	2 pole Plug	PX0931/02/S	2 pole Socket
PX0931/03/P	3 pole Plug	PX0931/03/S	3 pole Socket
PX0931/04/P	4 pole Plug	PX0931/04/S	4 pole Socket
PX0931/05/P	5 pole Plug	PX0931/05/S	5 pole Socket
PX0931/07/P	7 pole Plug	PX0931/07/S	7 pole Socket
PX0931/10/P	10 pole Plug	PX0931/10/S	10 pole Socket

Flange Mounted Connector



PX0941

- Mates with PX0911 and PXA911 connectors
- Supplied with high grade sealing gasket
- Supplied with sealing grommets for panel fixing screws (M6 thread recommended)

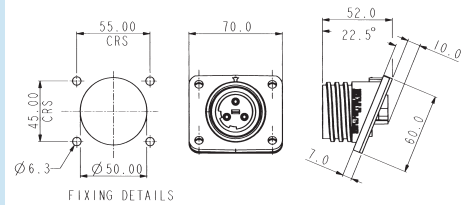

**Flange Mounting**

PX0941/02/P	2 pole Plug	PX0941/02/S	2 pole Socket
PX0941/03/P	3 pole Plug	PX0941/03/S	3 pole Socket
PX0941/04/P	4 pole Plug	PX0941/04/S	4 pole Socket
PX0941/05/P	5 pole Plug	PX0941/05/S	5 pole Socket
PX0941/07/P	7 pole Plug	PX0941/07/S	7 pole Socket
PX0941/10/P	10 pole Plug	PX0941/10/S	10 pole Socket

Additional Bulkhead Adaptor Moulding



PX0950

Additional Bulkhead Adaptor Moulding



PX0950 & PX0941

- For use with flange mounting connector PX0941, to give 45° or 90° angle
- Supplied with high grade sealing gasket
- Supplied with sealing grommets for panel fixing screws (M6 thread recommended)

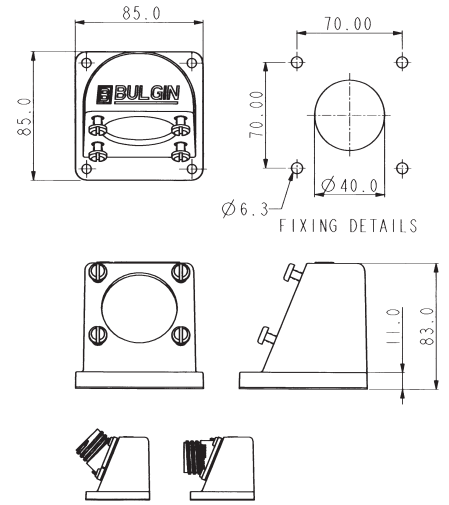

Accessories



PX0960, PX0970

- Sealing caps to maintain IP68 rating of unmounted connectors, with plastic straps

**Sealing Caps**

- PX0960 Sealing cap for use with PX0911/xx/x and PXA911/xx/x
- PX0970 Sealing cap for use with all other styles
- PX0990 Heavy duty sealing cap for use with PX0911/xx/x and PXA911/xx/x
- PX0991 Heavy duty sealing cap for use with PX0921/xx/x and PXA921/xx/x
- PX0992 Heavy duty sealing cap for use with PX0931W and PX0941

Accessories

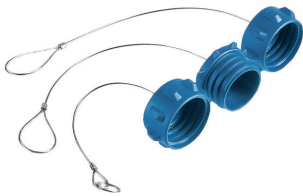

PX0990, PX0991, PX0992

- Heavy duty sealing caps to maintain IP68 rating of unmounted connectors, with stainless steel straps

**Gland Packs**

- PX0980 Pack of 3 additional cable glands for PX0911 and PX0921 to suit cable sizes; 11-13mm, 9-11 and 7-9mm dia.
- PXA980 Pack of 3 additional cable glands for PXA911 and PXA921 to suit cable sizes; 18-20mm, 16-18 and 14-16mm dia.

# BUCCANEER FOR POWER

## 900 Series Buccaneer

Specifications



### Electrical

No Poles:	2, 3	4, 5	7	10†
Current Rating:	32A 30A, CSA	32A 25A, CSA	32A 25A, CSA*	10A UL
Voltage Rating:	600V ac/dc	600V ac/dc	430V ac/dc	250V ac/dc
Contact Resistance:	<10m Ω (initial)			
Insulation Resistance:	>10 <sup>9</sup> MΩ (@ 500V dc)			
Dielectric strength:	2.2kV ac min			
AC Breakdown voltage:	6kV			
Operating Temperature Range:	-40°C to +85°C			
Approvals:	E214972 1211899 40003148 2011010203500396 – 10 Amp Rated 2011010203500396 – 32 Amp Rated			

\*with 75°C min. rated cable

### Material

Body Mouldings:	Polyamide
Flammability Rating:	UL94V-0
UV Resistance:	To EN50021: 1999
Contacts:	Machined Solid Brass, Nickel plated
O Rings:	Nitrile
Panel Sealing Gasket:	Silicone Rubber
RoHS	Compliant

### Contact Layout

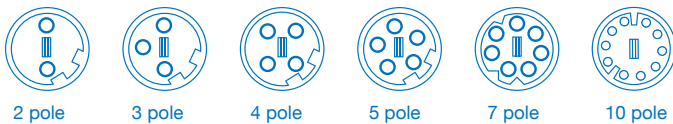

### Dimensions

Overall dimensions of connectors when mated together

PX0911 + PX0921 230 mm max.  
 PXA911 + PXA921 270 mm max.

PX0911 + PX0931 135 mm max. (to panel)  
 PXA911 + PX0931 175 mm max. (to panel)

PX0911 + PX0941 145 mm max.  
 (to panel, mid point on flange)

PXA911 + PX0941 174 mm max.  
 (to panel, mid point on flange)

### Mechanical:

Sealing:	IP69K, Tested in accordance with DIN 40050/Part 9 IP6K9K.
	IP68, EN60529:1992+A2:2013 tested @ 1.054kg/sq.cm. (15lb/sq.in.) 10m depth for 2 weeks
Salt Mist:	EN60068-2-52 Test Kb Salt Mist (Cyclic) Marine Severity Level 1
Cable Acceptance:	PX0911-PX0921 13 - 15mm O/D standard, 7-13mm with gland pack PXA911-PXA921 20 - 22mm O/D standard, 14 - 20mm with gland pack
Contact Accommodation:	2-7 pole - 2.5 to 4mm <sup>2</sup> (13 to 10AWG) conductor, single or multi stranded 10 pole - 0.75 to 2mm <sup>2</sup> (14 to 18AWG) conductor, single or multi stranded
Termination:	Axial screw terminals

Cable Retention force:	22mm dia, 150N 15mm dia, 150N 7mm dia, 80N
------------------------	--

Gland Nut Torques:	
PX0 range	
13-15mm (Yellow - std.)	3.16Nm (28 lbf.in.)
11-13mm (black)	3.16Nm (28 lbf.in.)
7-9mm (dark grey)	3.16Nm (28 lbf.in.)
PXA range	
20-22mm (Yellow - std.)	3.16Nm (28 lbf.in.)
18-20mm (black)	3.16Nm (28 lbf.in.)
16-18mm (white)	3.16Nm (28 lbf.in.)
14-16mm (dark grey)	3.16Nm (28 lbf.in.)

Tightening Torques:	
Panel mount nut	2.25Nm (20 lbf.in.)
Flange & Bulkhead fixing screws	0.9Nm (8 lbf.in.)
Inserts into Bodies	1.13Nm (10 lbf.in.) to 1.36Nm (12 lbf.in.)
Term screws - 2 to 5 poles	1.0Nm (9 lbf.in.) max
Term screws - 7 pole	0.4Nm (3.5 lbf.in.) max
Term screws - 10 pole	0.25Nm (2.2 lbf.in.) max

Rear thread PX0931 series M36 x 2-6g

PX X9      X      X      /      XX      /      X      /      XX

**Series Designation**

09 = Standard Cable Accommodation (7-13mm)

A9 = Large Cable Accommodation (14-22mm)

**Body Styles**

- 1 = Flex
- 2 = Flex In-line
- 3 = Panel
- 4 = Flange Panel

**Contact Termination**

- 1 = Screw Terminal

**Number Contacts**

- 02 = 2 pole
- 03 = 3 pole
- 04 = 4 pole
- 05 = 5 pole
- 07 = 7 pole
- 10 = 10 pole

**Contact Type**

P = Plug, S = Socket

**Cable Acceptance**

**EXP-0 version:**  
 Blank = 13-15mm  
 Yellow cable gland (std)

3 = 11-13mm  
 Black cable gland

2 = 9-11mm  
 White cable gland

1 = 7-9mm  
 Dark Grey cable gland

**EXP-A version:**  
 Blank = 20-22mm  
 Yellow cable gland (std)

9 = 18-20mm  
 Black cable gland

8 = 16-18mm  
 White cable gland

7 = 14-16mm  
 Dark Grey cable gland

**Example:**

PX0911/07/P/03 = Flex cable connector with standard cable accommodation body, seven pin contacts, with gland to suit 11-13mm cable.



- ⊗ IP68 rating tested at 1.054kg/sq cm (15lb/sq in) 10m depth for 2 weeks and 9.84kg/sq cm (140lb/sq in) 100m depth for 12 hours
- ⊗ IP69K, Tested in accordance with DIN 40050/Part 9 IP6k9K
- ⊗ Water and dustproof to IP68 when mated
- ⊗ 2, 3, 4, 6, 7, 9, 12 and 25 pole
- ⊗ 12A, 277V ac/dc 2 pole screw terminal, 3 pole screw terminal and crimp contacts
- ⊗ 10A, 277V ac/dc 4 pole screw terminal
- ⊗ 5A, 277V ac/dc 6 and 7 pole screw terminal
- ⊗ 5A, 150V ac/dc 9 pole crimp contacts
- ⊗ 5A, 50V ac/dc 12 pole crimp and solder contacts
- ⊗ 1A, 50V ac/dc 25 pole crimp and solder contacts
- ⊗ Plug or socket connection in each body style
- ⊗ Compact design
- ⊗ Diameter over coupling ring 38mm
- ⊗ Sealing caps available to maintain IP68 rating of unmated connectors
- ⊗ 7 body styles - flex cable, in-line flex cable, panel mount (front), panel mount (rear), PCB mount, bulkhead and flange mount
- ⊗ Leading earth contact for 3 pole socket version
- ⊗ Positive locating keyways - cannot be mis-connected
- ⊗ Easy assembly - no special tools required on screw terminal versions
- ⊗ Cable range from 3.5mm - 9mm
- ⊗ Colour coded identification variants
- ⊗ Pre-wired, overmoulded cable assemblies
- ⊗ CCC, UL, CSA and VDE approvals
- ⊗ EN60068-2-52 Test Kb Salt Mist (Cyclic) Marine Severity Level 1

Flex Cable Connector



PX0731

- Mates with In-Line Flex or Panel Mounting Versions
- Screw Locking Ring
- Pin or Socket Versions
- Leading Earth on 3 pole connectors
- Poles 2, 3, 4, 6, 7, 9, 12, 25
- Standard Cable Acceptance (2 to 9 pole) 6-8mm, 3.5-9mm with alternative glands

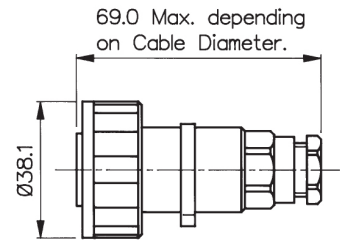

Poles	Termination	Pin Contacts	Socket Contact	Contacts
2	Screw	PX0736/P	PX0736/S	Supplied Fitted
3	Screw	PX0731/P	PX0731/S	Supplied Fitted
3	Crimp	PX0776/P	PX0776/S	Supplied Loose
4	Screw	PX0748/P	PX0748/S	Supplied Fitted
6	Screw	PX0739/P	PX0739/S	Supplied Fitted
7	Screw	PX0745/P	PX0745/S	Supplied Fitted
9	Crimp	PX0728/P	PX0728/S	Supplied Loose
12	Crimp/Solder	PX0794/P	PX0794/S	Order Separately
25	Crimp/Solder	PX0820/P	PX0820/S	Order Separately

Inline Flex Cable Connector



PX0732

- Mates with Flex or Panel Mounting Versions
- Screw Locking Ring
- Pin or Socket Versions
- Leading Earth on 3 pole connectors
- Poles 2, 3, 4, 6, 7, 9, 12, 25
- Standard Cable Acceptance (2 to 9 pole) 6-8mm, 3.5-9mm with alternative glands

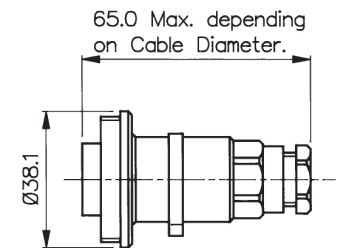

Poles	Termination	Pin Contacts	Socket Contact	Contacts
2	Screw	PX0737/P	PX0737/S	Supplied Fitted
3	Screw	PX0732/P	PX0732/S	Supplied Fitted
3	Crimp	PX0778/P	PX0778/S	Supplied Loose
4	Screw	PX0749/P	PX0749/S	Supplied Fitted
6	Screw	PX0740/P	PX0740/S	Supplied Fitted
7	Screw	PX0746/P	PX0746/S	Supplied Fitted
9	Crimp	PX0729/P	PX0729/S	Supplied Loose
12	Crimp/Solder	PX0795/P	PX0795/S	Order Separately
25	Crimp/Solder	PX0821/P	PX0821/S	Order Separately

Pre Wired Flex Cable Connector



PX0700

- Overmoulded cable assemblies
- Up to 14mm dia cable with PVC or PU jackets
- PX0700 flex cable connector
- Mates with in-line flex connector and all panel connectors

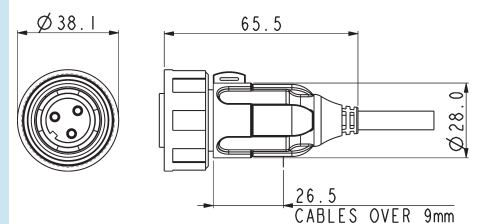

Front Panel Mounting Connector



PX0730/P

- Mates with Flex Cable Connector
- Front panel mounting
- Single Hole Fixing
- Pin or Socket Versions
- Poles 2, 3, 4, 6, 7, 9, 12, 25

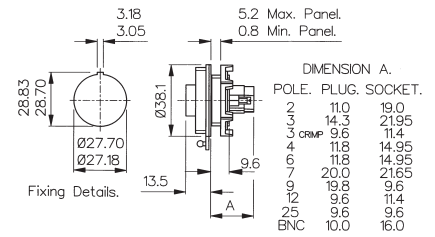

Poles	Termination	Pin Contacts	Socket Contact	Contacts
2	Screw	PX0735/P	PX0735/S	Supplied Fitted
3	Screw	PX0730/P	PX0730/S	Supplied Fitted
3	Crimp	PX0779/P	PX0779/S	Supplied Loose
4	Screw	PX0747/P	PX0747/S	Supplied Fitted
6	Screw	PX0738/P	PX0738/S	Supplied Fitted
7	Screw	PX0744/P	PX0744/S	Supplied Fitted
9	Crimp	PX0727/P	PX0727/S	Supplied Loose
12	Crimp/Solder	PX0796/P	PX0796/S	Order Separately
25	Crimp/Solder	PX0822/P	PX0822/S	Order Separately

Rear Panel Mounting Connector



PX0709/x/xx

- Mates with Flex Cable Connector
- Rear panel mounting
- Single Hole Fixing
- Pin or Socket Versions
- Poles 2, 3, 4, 6, 7, 9, 12 or 25

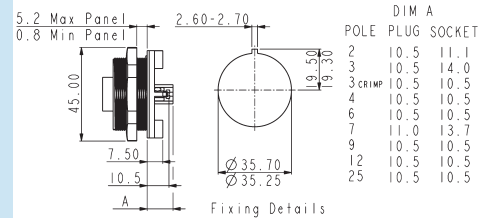

Poles	Termination	Pin Contacts	Socket Contact	Contacts
2	Screw	PX0709/P/02	PX0709/S/02	Supplied Fitted
3	Screw	PX0709/P/03	PX0709/S/03	Supplied Fitted
3	Crimp	PX0708/P/03	PX0708/S/03	Supplied Loose
4	Screw	PX0709/P/04	PX0709/S/04	Supplied Fitted
6	Screw	PX0709/P/06	PX0709/S/06	Supplied Fitted
7	Screw	PX0709/P/07	PX0709/S/07	Supplied Fitted
9	Crimp	PX0708/P/09	PX0708/S/09	Supplied Loose
12	Crimp/Solder	PX0708/P/12	PX0708/S/12	Order Separately
25	Crimp/Solder	PX0708/P/25	PX0708/S/25	Order Separately

Spring Loaded Sealing Cap



PX0713

- IP54 rated
- Spring loaded
- Clip shut to seal
- For use with front of panel mounting connector types

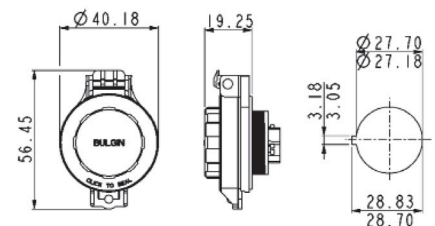

PCB Mounting Connector



PX0707/P/12

- Mates with Flex Cable connector
- Rear panel mounting
- No. poles: 3, 4, 6, 9, 12 or 25
- Pin or socket versions
- Pre-loaded Gold Plated contacts

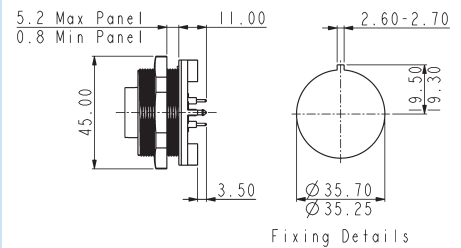

Poles	Termination	Pin Contacts	Socket Contact	Contacts
3	PCB	PX0707/P/03	PX0707/S/03	Supplied Fitted
4	PCB	PX0707/P/04	PX0707/S/04	Supplied Fitted
6	PCB	PX0707/P/06	PX0707/S/06	Supplied Fitted
9	PCB	PX0707/P/09	PX0707/S/09	Supplied Fitted
12	PCB	PX0707/P/12	PX0707/S/12	Supplied Fitted
25	PCB	PX0707/P/25	PX0707/S/25	Supplied Fitted

Bulkhead Flange Mounting Connector



PX0756/S

- Mates with Flex Cable Connector
- Screw Fixing Flange
- Pin or Socket Versions
- Poles 2, 3, 4, 6, 7, 9, 12, 25
- Supplied with sealing gasket and screw sealing grommets

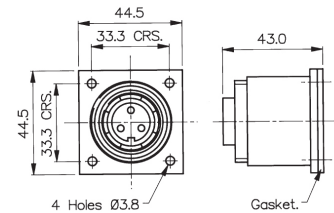

Poles	Termination	Pin Contacts	Socket Contact	Contacts
2	Screw	PX0757/P	PX0757/S	Supplied Fitted
3	Screw	PX0756/P	PX0756/S	Supplied Fitted
3	Crimp	PX0787/P	PX0787/S	Supplied Loose
4	Screw	PX0761/P	PX0761/S	Supplied Fitted
6	Screw	PX0758/P	PX0758/S	Supplied Fitted
7	Screw	PX0760/P	PX0760/S	Supplied Fitted
9	Crimp	PX0762/P	PX0762/S	Supplied Loose
12	Crimp/Solder	PX0798/P	PX0798/S	Order Separately
25	Crimp/Solder	PX0823/P	PX0823/S	Order Separately

Low Profile Flange Mounting Connector



PX0765/S

- Screw Flange Fixing
- Pin or Socket Versions
- Poles 2, 3, 4, 6, 7, 9, 12, 25
- Mates with Flex Cable Connector
- Supplied with sealing gasket and screw sealing grommets

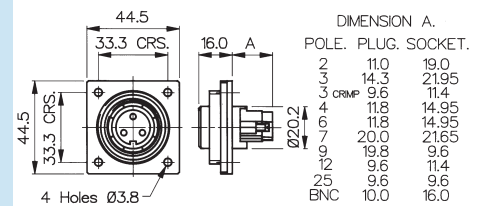

Poles	Termination	Pin Contacts	Socket Contact	Contacts
2	Screw	PX0764/P	PX0764/S	Supplied Fitted
3	Screw	PX0765/P	PX0765/S	Supplied Fitted
3	Crimp	PX0781/P	PX0781/S	Supplied Loose
4	Screw	PX0766/P	PX0766/S	Supplied Fitted
6	Screw	PX0767/P	PX0767/S	Supplied Fitted
7	Screw	PX0768/P	PX0768/S	Supplied Fitted
9	Crimp	PX0769/P	PX0769/S	Supplied Loose
12	Crimp/Solder	PX0797/P	PX0797/S	Order Separately
25	Crimp/Solder	PX0824/P	PX0824/S	Order Separately



Coloured Contact Inserts



Coloured Inserts

- With or without matching gland nut
- Positive visual identification
- Available in; Black, Blue, Green, Grey, Light Grey, Red, White and Yellow

Contact Inserts Colour Options

Part No	Suffix Colour
Blank	Black
BL	Blue
GN	Green
GY	Grey
LG	Light Grey
RD	Red
WH	White
YL	Yellow

Insert/Gland Nut Combinations

1	Insert and Gland Nut Coloured
2	Insert Only Coloured

E.g. PX0731/P/YL1 = Yellow insert and gland nut

Contacts for 12 and 25 Pole Inserts



12 and 25 way contacts

- Crimp or Solder Pins and Sockets
- Gold Plated
- Current ratings:  
12 way: 5A, 50V  
25 way: 1A, 50V

Contacts - Solder & Crimp for 12 and 25 pole

Contacts (for 25 pole) (Supplied in packs of 10)	Solder	Crimp
Pins	SA3180/1	SA3180
Sockets	SA 3179/1	SA3179
Contacts (for 12 pole) (Supplied in packs of 10)	Solder	Crimp
Pins	SA3348/1	SA3348
Sockets	SA3347/1	SA3347

Assembly Tools



PNo 14025 and 13027

- Crimp Tools for 3, 9, 12 and 25 pole crimp contacts
- Insertion/Extraction Tool for 25 pole contacts

Tools

Crimp Tool (25 pole)	PNo. 14025/1AMP
Crimp Tool (12 pole)	PNo. 14025
Positioner (12 pole)	PNo. 14025/5AMP
Crimp Tool (9 pole)	PNo. 13826
Crimp Tool (3 pole)	PNo. 14232
3 pole positioner	PNo. 14232/1
Insertion/Extraction Tool (25 pole)	PNo. 13027
Insertion/Extraction Tool (12 pole)	PNo. 13027/1
Insertion/Extraction Tool (3 pole)	PNo. 13027/3

Cable Glands



SA3253

- Pack of alternative cable glands to suit cables from 3.5 to 9mm dia.

Cable Acceptance - Alternatives

Gland Diameter	Gland Part No.	Gland Colour	Additional Suffix
6-8mm	12023	Black	Standard for 2-12 pole
3.5-5mm	SA3426	Grey	Suffix /04†
5-7mm	12023/1	White	Suffix /05
7-9mm	12023/2	Yellow	Suffix /07*
Gland Pack	SA3253	Pack of 3 glands to suit cables 3.5-5mm, 5-7mm & 7-9mm dia†	

\*Note: 7-9mm gland standard for 25 way, no suffix required.  
†Includes additional black gland cage for 3.5-5mm dia. cable range.

To order connector with alternative cable gland add suffix to part no. e.g. PX0731/P/07 = PX0731 3 pin connector with cable gland to suit 7-9mm dia. cable.

Cable Acceptance - Standard as supplied

No. Contacts	Cable Diameter or Type
2-12 Pole	6-8mm
25 Pole	7-9mm

Sealing Cap and Assembling Tool



PX0734 PX0733

- Maintains IP68 Rating of Unmated Connectors
- Can be used to remove Inserts
- PX0734 for Flex Cable Connector
- PX0733 for In-line Flex, Front Panel, Bulkhead and Flange mount connectors
- PX0711 for PCB and Rear Panel Mount connectors

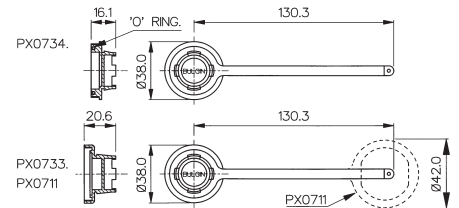

Rear of Panel Back Shell



PX0799

- Provides environmental seal to rear of panel
- Standard cable acceptance 6-8mm, 3.5 to 9mm with alternative glands
- For use on front panel mounting connectors
- Replaces mounting nut in panel connector

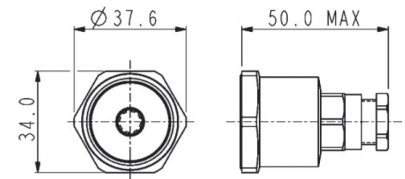

PVC Insulation Boot



PNo. 12855

- Shock protection for rear of connector
- Flammability Rating UL94V-0
- Fits Front Panel Mount Versions only

12855 for panel mounting types only.

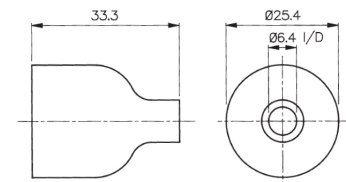

Cable Support Accessory



PNo. 12237

- Gives Extra Support to the Cable
- Suitable for 5-7mm and 7-9mm Cable Diameters

12237 provides additional cable support. Suitable for 5-7mm and 7-9mm cables.

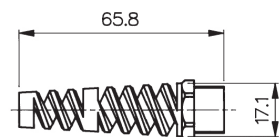

PX0xxx	X	XX	XX	X
<b>Body Styles</b>	<b>Contacts Type</b> P = Pin S = Socket	<b>Cable Acceptance or PCB/Rear Panel Mounting</b>  Flex Cable and In-line Flex Connectors cable acceptance use: Blank = 6-8mm (Black) standard for 2-12 pole  04 = 3.5-5mm (Grey) 05 = 5-7mm (White) 07 = 7-9mm (Yellow) (standard for 25 way, no suffix required)  PCB (PX0707) and Rear Panel Mount connectors (PX0708 and PX0709) use:  02 = 2 pole      03 = 3 pole 04 = 4 pole      06 = 6 pole 07 = 7 pole      09 = 9 pole 12 = 12 pole     25 = 25 pole  Front Panel, Bulkhead and Flange Mount - not required:	<b>Insert/Gland Nut Colour</b>  Blank = Black BL = Blue GN = Green GY = Grey  LG = Light Grey RD = Red WH = White YL = Yellow	<b>Insert/Gland Nut Colour Combination</b>  1 = Insert and Gland Nut Coloured 2 = Insert only Coloured

**Examples:**

PX0707/P/06= PCB Panel pin connector, pin contacts, 6 pole  
 PX0731/S = Flex Cable connector, socket contacts, 3 pole  
 PX0732/P/07/BL2 = In-Line Flex Cable connector, pin contacts, 3 pole, 7-9mm cable acceptance, blue insert

**PCB Layouts**

**Sockets**

Contact Nos viewed from rear of panel

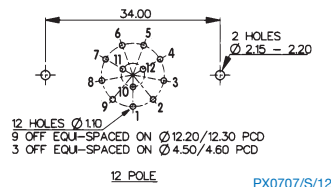
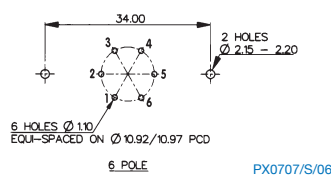
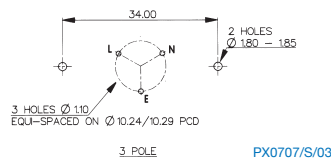



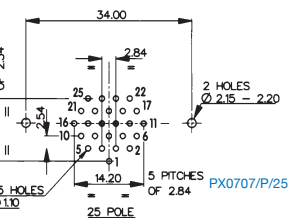
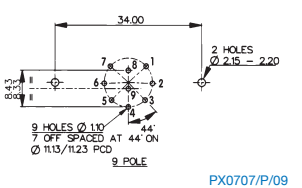
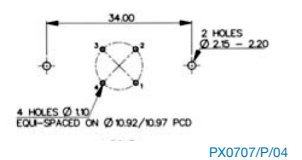
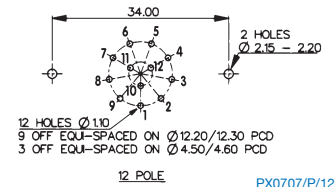
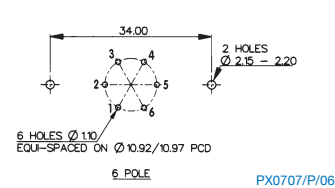
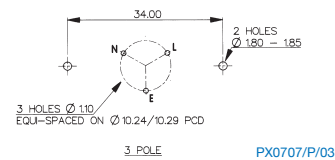
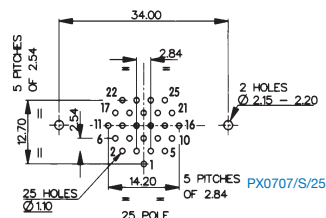
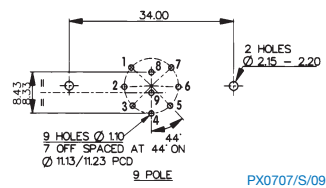
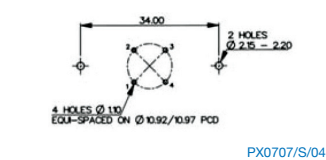

**Pins**

Contact Nos viewed from rear panel rear of panel



### Electrical:

No. Poles:	2, 3	4	6, 7	9	12	25
Current Rating:						
VDE	12A	10A	5A	5A	5A	1A
UL, CSA	10A	6A	3A	5A	5A	1A
Voltage Rating (ac/dc):	277V	277V	277V	150V	50V	50V
Contact Resistance:	<10mΩ (2-9 Pole)					
	<5mΩ (12 Pole)					
	<5mΩ (25 Pole)					
Insulation Resistance:	>10 <sup>4</sup> MΩ @ 500V d.c. (2-9 Pole)					
AC Breakdown voltage:	4kV Pole - Pole (2-9 Pole)					
	6kV Poles - Panel (Low Profile Flange and Panel Types - 2-9 Pole)					
	7.5kV Poles - Panel (Other Types - 2-9 Pole)					
Operating Temp. Range:	-20°C to +70°C					
Approvals:	E93288 and E337507					
 UL	LR80968-30					
 CSA	40023148					
 VDE	2011010203500391 - 1 Amp Rated					
 CCC	2011010203500393 - 5 Amp Rated					
	2011010203500394 - 10 Amp Rated					
	2011010203500395 - 12 Amp Rated					
	Overmoulded cable assemblies approvals to customer requirements.					

### Material:

Body Mouldings:	Glass Filled Polyamide UL94HB
Inserts (2-25 pole):	Polyamide UL94V-0
PX0707	Polyamide UL94V-0
PX0708	Polyamide UL94V-0
PX0709	Polyamide UL94V-0
Overmoulded types:	
Body Mouldings:	Polyurethane
Flammability Rating:	UL94V-HB
Contacts:	
Screw Terminal:	Brass, Nickel Plated
Crimp (9 pole):	Copper Alloy, Tin Plated
Crimp/Solder (12+25 Pole):	Copper Alloy, Gold Plated (0.1µm on Nickel)
BNC inserts:	Brass, Nickel Plated
BNC contacts:	Brass, Silver Plated
RoHS	Compliant

### Mechanical:

Sealing:	IP69K, Tested in accordance with DIN 40050/Part 9 IP6k9k
	IP68, EN 60529:1992+A2:2013 Tested @ 1.054kg/sq.cm. (15lb/sq.in.) 10m depth for 2 weeks.
	EN 60529:1992 +A2:2013 Tested @ 9.84kg/sq.cm. (140lb/sq.in.) 100m depth for 12 hours.
Salt Mist:	EN60068-2-52 Test Kb Salt Mist (Cyclic) Marine Severity Level 1
Cable Acceptance:	
2-12 Pole - standard gland:	6-8mm dia
2-12 Pole - alternative glands:	3.5-9mm dia
25 Pole - standard gland:	7-9mm dim
25 Pole - alternative glands:	3.5-7mm dim
Contact Accommodation:	
2 and 3 pole screw terminals:	4mm <sup>2</sup> (12AWG) max
3 pole crimp:	1.0-1.5mm <sup>2</sup> (14-18AWG) max
4, 6 and 7 pole:	1.5mm <sup>2</sup> (16AWG) max
9 pole:	0.12-0.21mm <sup>2</sup> (24-26AWG)
12 pole:	0.32mm <sup>2</sup> (22-26AWG) max
25 pole:	0.12-0.21mm <sup>2</sup> (24-26AWG)
Terminations:	
2-7 Pole:	Screw Terminals
3 Pole:	Screw Terminals & Crimp
9 Pole:	Crimp Contacts
12 Pole:	Crimp & Solder Contacts
25 Pole:	Crimp & Solder Contacts
Tightening Torques:	
Flex Mounting/In-Line:	Gland Nut: 1.13Nm (10lbf.in.)
Panel Mounting:	Rear Fixing Nut: 1.7Nm (15lbf.in.)
	Front Fixing Nut: 1.7Nm (15lbf.in.)
Surface/Bulkhead and Low Profile Flange Mounting:	4 Fixing Screws (using washers supplied) 0.34Nm (3lbf.in.)
Sealings Caps/Locking Ring:	1.13Nm (10lbf.in.)
Rear thread, Front Panel Connector:	M27 x 1.0-6H
Thread, Front Panel Connector:	M35 x 1.0-6H

Cable Joiner



PX0777

- IP68 & IP69k Rating
- For Sealed In-Line Connections
- Standard Cable Acceptance 6-8mm
- Cable Range 3.5-9mm (using alternative glands)
- Supplied with 4, 6 or 8 way Terminal Block
- Available Moulded in Black or Orange

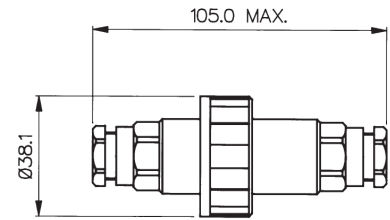

**Specifications**

**PX0777**

**PX0777/4POLE, 6POLE, 8POLE**

**POLE Configurations**

Rating:	16A, 250V a.c.	10A, 250V a.c.	
Wire Termination:	3 way Terminal Block	4, 6, 8 way Terminal Block	
Conductor Accommodation:	2.5mm <sup>2</sup> max (14AWG)	1.5mm <sup>2</sup> max (16AWG)	
Cable Acceptance:	6-8mm dia alternative glands available on request	6-8mm dia alternative glands available on request	
Material:	Glass Filled Polyamide UL94-HB	Glass Filled Polyamide UL94-V0	
Sealing:	IP68 to BSEN 60529 : 1992 1.054kg/sq.cm. (15lbs/sq.in.) 10m depth for 2 weeks	IP68 to BSEN 60529 : 1992 1.054kg/sq.cm. (15lbs/sq.in.) 10m depth for 2 weeks	
Salt Mist	IP69k to DIN 40050-9	IP69k to DIN 40050-9	
Operating Temp. Range:	EN60068-2-52 Test Kb Salt Mist (Cyclic) Marine Severity Level 1	EN60068-2-52 Test Kb Salt Mist (Cyclic) Marine Severity Level 1	
Colour:	-20°C to +70°C	-20°C to +70°C	
Colour:	Black Orange (Add /OR to PNo.)	Black Orange (Add /OR to PNo.)	
RoHS	Compliant	Compliant	

**Examples**

- PX0777 – 3 Pole 6-8mm Black.
- PX0777/04 – 3 Pole 3.5-5.0mm Black.
- PX0777/04/OR – 3 Pole 3.5-5.0mm Orange.
- PX0777/4POLE – 4 Pole 6-8mm Black.
- PX0777/6POLE/04 – 6 Pole 3.5-5.0mm Black.
- PX0777/8POLE/04/OR – 8 Pole 3.5-5.0mm Orange.

<b>PX0777</b>	<b>XPOLE</b>	<b>XX</b>	<b>XX</b>
Part No	Blank = 3 Pole 4POLE = 4 Pole 6POLE = 6 Pole 8POLE = 8 Pole	Blank = 6-8mm 04 = 3.5-5mm 05 = 5-7mm 07 = 7-9mm	Blank = Black OR = Orange



- ⊕ Water and dustproof to IP68 when mated
- ⊕ IP68 rating tested at 1.054kg/sq cm (15lb/sq in) 10m depth for 2 weeks
- ⊕ 2, 3, 4 or 6 pole screw terminal inserts
- ⊕ 3 or 8 pole solder or crimp inserts
- ⊕ 5 body styles, Flex, Flex In-Line, Panel (2 styles), Panel Side Entry
- ⊕ 50Ω or 75Ω BNC inserts
- ⊕ 5A, 380V a.c. 3 & 8 way solder/crimp terminals
- ⊕ 10A, 250V a.c. 2 & 3 way screw terminals
- ⊕ 6A, 250V a.c. 4 way screw terminal
- ⊕ 3A, 250V a.c. 6 way screw terminals
- ⊕ EN60068-2-52 Test Kb Salt Mist (Cyclic) Marine Severity Level 1
- ⊕ Plug or socket connection in each body style
- ⊕ Cable range from 3.5mm - 9mm
- ⊕ Diameter over coupling ring 26mm
- ⊕ Positive locating keyways - cannot be mis-mated
- ⊕ Sealing caps available to maintain IP68 rating of unmated connectors
- ⊕ Flammability rating UL94V-0 material
- ⊕ Leading earth pin is on 3, 4 & 6 pole screw terminal versions only
- ⊕ Compact design
- ⊕ Easy assembly - no special tools required on screw terminal versions
- ⊕ UL approval

Flex Cable Connector



PX0800 - shown with insert

- PX0800 Connector body
- Mates with Flex In-line or Panel Mounting versions
- Screw locking ring
- Suitable for Pin or Socket inserts
- Cable Acceptance 3.5-9mm (Standard 5-7mm)
- Contact inserts supplied separately

61.5 Max. Depending on Cable Dia. / Pin or Socket Carrier.

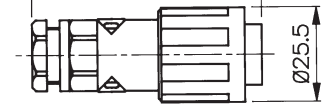

Inline Flex Cable Connector



PX0801 - shown with insert

- PX0801 Connector body
- Mates with PX0800 - Flex Cable connector
- Suitable for Pin or Socket inserts
- Cable Acceptance 3.5-9mm (Standard 5-7mm)
- Contact inserts supplied separately

61.5 Max. Depending on Cable Dia. / Pin or Socket Carrier.

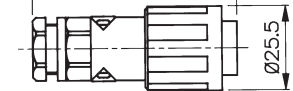

Panel Mounting



PX0802 - shown with insert

- PX0802 Connector body
- Mates with PX0800 - Flex Cable connector
- Single hole fixing
- Suitable for Pin or Socket inserts
- Contact inserts supplied separately

37.0 Max. Depending on Pin or Socket Carrier.

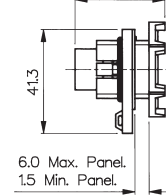

3.2<sub>±0.1</sub>

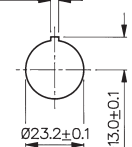

Fixing Details.

Panel Mounting



PX0803 - shown with insert

- PX0803 Connector body
- Mates with PX0800 - Flex Cable connector
- Right angle cable entry
- Single hole fixing
- Suitable for Pin or Socket inserts
- Contact inserts supplied separately

53.4 Max. Depending on Panel Thickness.

53.4 Max. Depending on Socket or Pin Carrier.

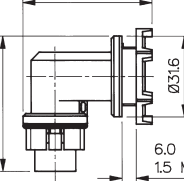

3.2<sub>±0.1</sub>

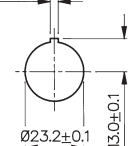

Fixing Details.

Panel Mounting



PX0805 - shown with insert

- PX0804 and PX0805 Connector bodies
- Mates with PX0800 - Flex Cable connector
- PX0804 without sealing cap retaining clip, PX0805 with sealing cap retaining clip
- Single hole fixing
- Suitable for Pin or Socket inserts
- Contact inserts supplied separately

32.8 Max. Depending on Pin or Socket Carrier.

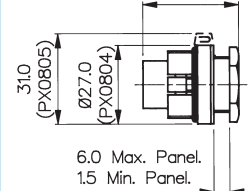

3.2<sub>±0.1</sub>

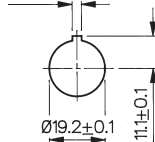

Fixing Details.

Screw Terminal Inserts



- 2, 3, 4 and 6 Poles
- Fits all Body Styles
- Leading Earth Pin on 3, 4 and 6 pole inserts
- Nickel Plated contacts

Screw Terminal Inserts - fits all body styles

No. poles	Sockets	Pins
2	SA3319	SA3320
3	SA3229	SA3230
4	SA3242	SA3241
6	SA3244	SA3243

Contact Carrier Inserts



Inserts shown with contacts fitted

- For Solder or Crimp Contacts
- 3 or 8 Pin
- Fits all Body Styles
- Contacts Supplied Separately

Solder & Crimp Contact Carrier Inserts - fit all body styles.

No. poles	Solder	Colour	Crimp	Colour
8 Pin	12734/1	Black	12734	Grey
8 Socket	12735/1	Black	12735	Grey
3 Pin	12734/3/1	Black	12734/3	Grey
3 Socket	12735/3/1	Black	12735/3	Grey

Contacts, Polarising/Blanking Pins



- Gold Plated contacts
- Solder or Crimp
- Polarising/Blanking pins

Contacts - Solder & Crimp - for contact carrier inserts

Contacts (Supplied in packs of 10)	Solder	Crimp
Pins		SA3148/1 SA3148
Sockets		SA3149/1 SA3149
Polarising/Blanking Pins		SA3147
Contact Insertion Tool: Must be used to load contacts into inserts.		SA3150
Crimping Tool		SA2800

Sealing Caps



To maintain IP rating

PX0810

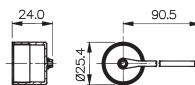

PX0810  
Fits PX0801, PX0802, PX0803, PX0804 & PX0805. Ensure "O" Ring is in place on main body.

PX0811

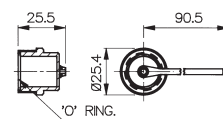

PX0811  
Fits PX0800. Ensure "O" Ring is in place in cap.





Electrical	Solder/Crimp Terminals	Screw Terminals			BNC
No Poles:	3, 8	2, 3	4	6	
Current Rating:	5A	10A	6A	3A	
Voltage Rating:	380V ac	250V ac	250V ac	250V ac	
Contact Resistance:	<5mΩ				
Insulation Resistance:	>10 <sup>6</sup> MΩ @ 500V d.c.				
Voltage Proof:	2kV @ 50Hz				
Operating Temp. Range:	-20°C to +70°C				

Approvals:  
 E214972

Materials	Solder/Crimp Terminals	Screw Terminals	BNC
Body Mouldings:	Polyamide UL94V-0	Polyamide UL94V-0	
Inserts:	Polyamide UL94V-0	Polyamide UL94V-0	
Contacts:	Copper Alloy, Gold Plated (0.1µm) on Nickel	Brass, Nickel Plated	Brass, Silver Plated.
O Rings:	Nitrile		
<b>RoHS</b>	Compliant	Compliant	Compliant

Mechanical	Solder/Crimp Terminals	Screw Terminals	BNC
Sealing:	Protection Classification IP68, EN 60529:1992+A2:2013 Tested @ 1.054kg/sq.cm. (15lb/sq.in.) 10m depth for 2 weeks.		
Salt Mist:	EN60068-2-52 Test Kb Salt Mist (Cyclic) Marine Severity Level 1		
Cable Acceptance	5-7.00mm dia - standard gland 3.5-9.00mm dia - alternative glands		
Contact Accommodation:	0.2 - 0.5mm <sup>2</sup> (20 - 24 AWG)	1mm <sup>2</sup> max (18 AWG)	50Ω: RG58/CU, URM43, URM76 75Ω: URM70
Insertion Force (typical):	3 way: 5N (1.1lbf) 8 way: 14N (3.1lbf)	3 way: 45N (10lbf) 4 way: 50N (11lbf) 6 way: 140N (31lbf)	
Withdrawal Force (typical):	3 way: 3N (0.66lbf) 8 way: 12N (2.6lbf)	3 way: 32N (7lbf) 4 way: 40N (9lbf) 6 way: 150N (34lbf)	
Tightening Torques			
Gland Nut, PX0800, 801:	1.13Nm (10lbf in)		
Rear Nut, PX0802, 803, 804, 805:	0.7Nm min, 1.7Nm max (6.2lbf in min, 15lbf in max)		
Sealing Cap, PX0810, 811:	0.23Nm min, 1.13Nm max (2lbf in min, 10lbf in max)		

How to order	Cable Glands																								
<input type="checkbox"/> Choose body type, check cable diameter and sealing gland size.	Cable gland for 5-7mm fitted as standard. BNC Insert Kit includes gland & washer to fit coax cable.																								
<input type="checkbox"/> Determine contact carrier inserts. Choose number of poles, and type of contacts (solder, crimp, screw terminal or BNC).																									
<input type="checkbox"/> Choose pins or sockets. Solder and crimp contacts are supplied separately in packs of ten.																									
<input type="checkbox"/> Choose polarising/blanking pins. If required for solder/crimp contact inserts. Supplied in packs of ten.																									
<input type="checkbox"/> Is an insertion tool required (for solder or crimp contacts)?																									
<input type="checkbox"/> Is a crimp tool required?																									
<input type="checkbox"/> Is a sealing cap required?																									
	<table border="1"> <thead> <tr> <th>Cable Diameter</th> <th>Gland Part No.</th> <th>Gland Colour</th> <th>Additional Suffix</th> </tr> </thead> <tbody> <tr> <td>5-7mm</td> <td>12023/1</td> <td>White</td> <td>Fitted as standard</td> </tr> <tr> <td>3.5-5mm</td> <td>SA3426</td> <td>Grey</td> <td>Suffix /04†</td> </tr> <tr> <td>6-8mm</td> <td>12023</td> <td>Black</td> <td>Suffix /06</td> </tr> <tr> <td>7-9mm</td> <td>12023/2</td> <td>Yellow</td> <td>Suffix /07</td> </tr> <tr> <td>Gland Pack</td> <td>PX0812</td> <td>Pack of 3 glands to suit cables 3.5-5mm, 6-8mm, 7-9mm dia†</td> <td></td> </tr> </tbody> </table> <p>To order body with alternative cable gland add suffix to part no. e.g. PX0800/06 = PX0800 body with cable gland to suit 6-8mm dia. cable.                      †Includes additional black gland cage for 3.5-5mm dia. cable range.</p>	Cable Diameter	Gland Part No.	Gland Colour	Additional Suffix	5-7mm	12023/1	White	Fitted as standard	3.5-5mm	SA3426	Grey	Suffix /04†	6-8mm	12023	Black	Suffix /06	7-9mm	12023/2	Yellow	Suffix /07	Gland Pack	PX0812	Pack of 3 glands to suit cables 3.5-5mm, 6-8mm, 7-9mm dia†	
Cable Diameter	Gland Part No.	Gland Colour	Additional Suffix																						
5-7mm	12023/1	White	Fitted as standard																						
3.5-5mm	SA3426	Grey	Suffix /04†																						
6-8mm	12023	Black	Suffix /06																						
7-9mm	12023/2	Yellow	Suffix /07																						
Gland Pack	PX0812	Pack of 3 glands to suit cables 3.5-5mm, 6-8mm, 7-9mm dia†																							



- ⊕ IP68 rating tested at 1.054kg/sq cm (15lb/sq in) 10m depth for 2 weeks
- ⊕ IP69K, Tested in accordance with DIN 40050/Part 9 IP6k9k
- ⊕ 2 and 3 pole - 8A, 250V rating
- ⊕ 4, 6 and 8 pole - 5A, 125V rating
- ⊕ 10 and 12 pole - 1A, 50V rating
- ⊕ 2.5mm contact engagement for electrical integrity 'Scoop proof' contacts
- ⊕ Contact inserts are part of body moulding
- ⊕ Cable range from 3 to 7mm
- ⊕ Overall length (flex + flex in-line) 80mm
- ⊕ Gold plated contacts
- ⊕ Diameter over coupling ring 19.1mm
- ⊕ Pre-wired, overmoulded cable assemblies
- ⊕ Flex, Flex In-Line, Front Panel, Rear Panel and PCB mounting body styles
- ⊕ Plug and Socket versions in all body styles
- ⊕ Flame Retardant moulding material - Polyamide UL94-V0
- ⊕ Contacts supplied separately (except PCB versions)
- ⊕ Sealing caps available to maintain IP68 rating
- ⊕ Secure sealing system
- ⊕ Crimp and solder contacts
- ⊕ PCB mounting connector supplied with contacts pre-loaded
- ⊕ Front and rear panel mounting panel connectors
- ⊕ CCC, UL, CSA and VDE approvals
- ⊕ EN60068-2-52 Test Kb Salt Mist (Cyclic) Marine Severity Level 1

Flex Cable Connector



PX0410

- Mates with Flex In-line or Panel mounting versions PX0401, PX0411, PX0412 & PX0413
- Pin or socket
- 2, 3, 4, 6, 8, 10 or 12 pole
- Screw locking ring
- Contacts supplied separately

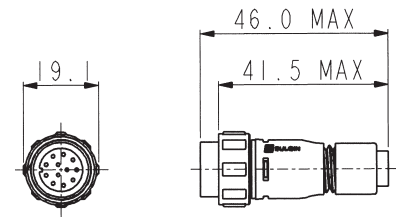

Inline Flex Cable Connector



PX0411

- Mates with Flex Cable connectors PX0400, PX0402 & PX0410
- Pin or socket
- 2, 3, 4, 6, 8, 10 or 12 pole
- For in-line cable connection
- Contacts supplied separately

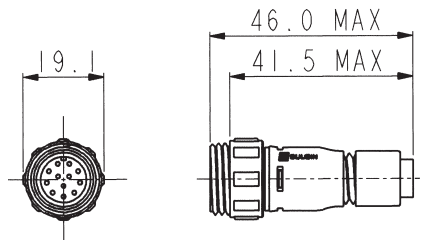

Pre Wired Flex Cable Connector



PX0400

- Overmoulded Flex connector for pre-wired cable assemblies
- Pin or socket
- Cable range 2.5 -9.0mm o/d
- 2, 3, 4, 6, 8, 10 or 12 pole
- Mates with PX0401 & PX0411 Flex In-Line connectors and PX0412 & PX0413 panel mounting connectors

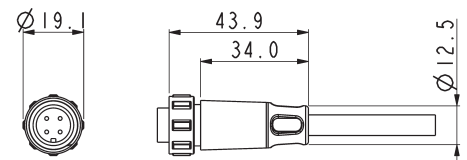

Pre Wired Flex Cable Connector



PX0402

- Right-angled overmoulded Flex connector for pre-wired cable assemblies
- Pin or socket
- Cable range 2.5 -9.0mm o/d
- 2, 3, 4, 6, 8, 10 or 12 pole
- Mates with PX0401 & PX0411 Flex In-Line connectors and PX0412 & PX0413 panel mounting connectors

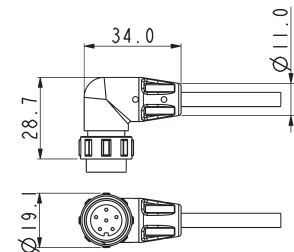

Pre Wired In-line Flex Connector



PX0401

- Overmoulded Flex connector for pre-wired cable assemblies
- Pin or socket
- Cable range 2.5 -9.0mm o/d
- 2, 3, 4, 6, 8, 10 or 12 pole
- Mates with PX0400, PX0402 & PX0410 Flex connectors

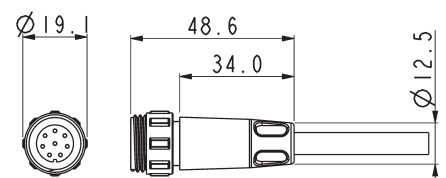

Front Panel Mounting Connector



PX0412

- Mates with Flex Cable connectors PX0410, PX0400 & PX0402
- Front Panel mounting
- Single hole fixing
- Contacts supplied separately
- 2, 3, 4, 6, 8, 10 or 12 pole

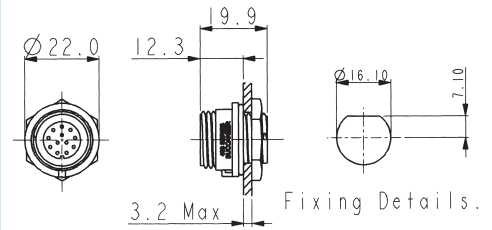

Rear Panel Mounting Connector



PX0413

- Mates with Flex Cable connector PX0410, PX0400 & PX0402
- Rear Panel mounting
- Single hole fixing
- Contacts supplied separately
- 2, 3, 4, 6, 8, 10 or 12 pole

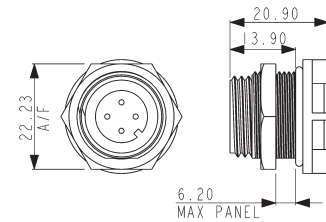

PCB Mounting Connector



PX0413

- Mates with Flex Cable connector PX0410, PX0400 & PX0402
- PCB Rear Panel mounting
- Straight PC spills
- Supplied with pre-loaded gold plated contacts
- 2, 3, 4, 6, 8, 10 or 12 pole

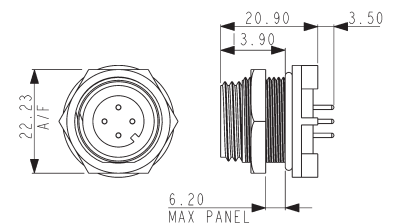

Sealing Caps and Accessories



PX0480 PX0480/1 PX0481 PX0484

- Maintains IP68 Rating of Unmated Connectors
- PX0480: Fits PX0412 (panel mounting)
- PX0480/1: Fits PX0401 & PX0411 (flex in-line)
- PX0481: Fits PX0400, PX0402 & PX0410 (flex connector)
- PX0484: Fits PX0413 (PCB and rear panel mount)

Gland Packs

Part No	Description
PX0482	Pack of 4 pairs cable glands and collets to suit cables from 3.0 to 5.0mm diameter.
PX0483	Pack of 4 pairs cable glands and collets to suit cables from 5.0 to 7.0mm diameter.

# BUCCANEER FOR POWER

## 400 Series Buccaneer

Specifications



### Crimp Contacts

Pole	Current Rating	Pin	Socket	Pack Qty	Cable Acceptance (dia)
2, 3	8A	SA3350	SA3349	10	20 - 24 AWG
4, 6, 8	5A	SA3348	SA3347	10	22 - 26 AWG
10, 12	1A	SA3180	SA3179	10	24 - 28 AWG

### Solder Contacts

Pole	Current Rating	Pin	Socket	Pack Qty	Cable Acceptance (dia)
2, 3	8A	SA3350/1	SA3349/1	10	20 - 24 AWG
4, 6, 8	5A	SA3348/1	SA3347/1	10	22 - 26 AWG
10, 12	1A	SA3180/1	SA3179/1	10	24 - 28 AWG

### Insertion / Extraction

	Poles	Contact Rating	Colour	Part No
Insertion/Extraction Tool	2,3	8A	Blue	13027/2
Insertion/Extraction Tool	4,6,8	5A	Red	13027/1
Insertion/Extraction Tool	10,12	1A	Green	13027

### Crimp tools

	Poles	Contact Rating	Colour	Part No
Positioner	2,3	8A	Blue	14025/8AMP
Positioner	4,6,8	5A	Red	14025/5AMP
Positioner	10,12	1A	Green	14025/1AMP
8 Indent Crimp Tool for use with positioners				14025

### PX0413 PCB Contact Layout

#### Sockets

Contact numbers viewed from rear of panel

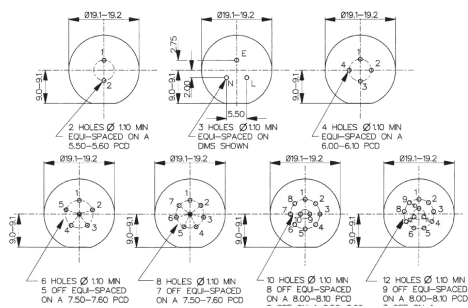

#### Plugs

Contact numbers viewed from rear of panel

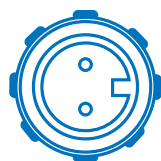
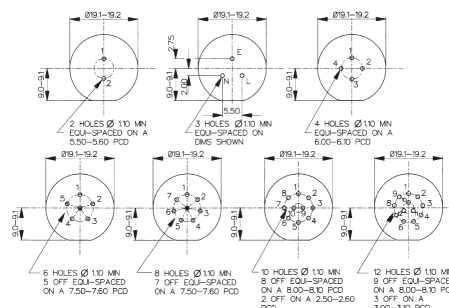

2 pole  
(8 Amp)



3 pole  
(8 Amp)



4 pole  
(5 Amp)



6 pole  
(5 Amp)



8 pole  
(5 Amp)

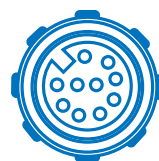

10 pole  
(1 Amp)

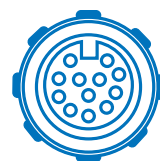





12 pole  
(1 Amp)

**Electrical:**

No. Poles:	2, 3	4, 6, 8	10, 12
Current Rating:	8A	5A	1A
Voltage Rating (ac/dc):	250Vac/dc	125Vac/dc	50Vdc
Contact Resistance:	<5mΩ		
Insulation Resistance:	>10 <sup>9</sup> MΩ (@ 500V d.c.)		
AC Breakdown voltage:	2.5kV		

Operating Temperature:	
Flex and panel types	-40°C to +80°C
Overmoulded	-20°C to +60°C

Approvals:	
 UL	E214972
 CSA	1273303
 VDE	40002226
 CCC	2011010203500398 – 1 Amp Rated 2011010203500399 – 5 Amp Rated 2011010203500400 – 8 Amp Rated
	Overmoulded cable assemblies approvals to customer requirements.

**Material:**

Flex and panel types:	
Body Mouldings:	Polyamide
Flammability Rating:	UL94V-0
UV Resistance:	To EN 50021:1999
Overmoulded types:	
Body Mouldings:	Polyurethane
Flammability Rating:	UL94V-HB
Contacts:	Copper alloy, Gold plated
O Rings:	Nitrile
Panel Sealing O Ring:	Nitrile
<b>RoHS</b>	Compliant

**Mechanical:**

Sealing:	IP69K, Tested in accordance with DIN 40050/Part 9 IP6k9k
	IP68, EN60529:1992+A2:2013 tested @ 1.054kg/sq cm (15lb/sq in) 10m depth for 2 weeks

Salt Mist:	EN60068-2-52 Test Kb Salt Mist (Cyclic) Marine Severity Level 1
------------	---

Cable Acceptance:	3.0 - 7.0mm
-------------------	-------------

Contact Accommodation:	2, 3 pole, 20 - 24 AWG 4, 6, 8 pole, 22 - 26 AWG 10, 12 pole, 24 - 28 AWG
------------------------	---

Termination:	Crimp, solder and PCB
--------------	-----------------------

Insertion/Withdrawal Force:	
No. poles:	2 3 4 6 8 10 12
Insertion Force (typ):	19N 25N 27N 27N 28N 55N 62N
Withdrawal Force (typ):	12N 17N 17N 21N 22N 25N 29N

Tightening Torques:	
Panel mount (PX0412)	
Rear fixing nut:	1.0-1.1Nm (9lbf.in.)
Panel mount (PX0413)	
Front fixing nut:	1.0-1.1Nm (9lbf.in.)

Cable Retention force:	
3.0mm dia	60N
4.0 to 7.0mm dia	80N

Rear panel thread PX0412:	M16x1.5
---------------------------	---------

Panel thread PX0413:	18.97x26TPI Whitworth form to BS84 med fit
----------------------	--

**Dimensions:**

Overall dimensions of connectors when mated together

Flex + Flex In-Line	80mm
Dia. over coupling ring	19.1mm

Dia. over coupling ring

<b>PX04 xx</b>	<b>/</b>	<b>XX</b>	<b>X</b>	<b>/</b>	<b>XXXX</b>
<p><b>Body Styles</b></p> <p>PX0410 = Flex body                      PX0411 = Flex in-line body                      PX0412 = Front panel mounting body                      PX0413 = Rear panel/PCB mounting body</p>		<p><b>Number Contacts</b></p> <p>02 = 2 pole,                      03 = 3 pole,                      04 = 4 pole,                      06 = 6 pole,                      08 = 8 pole,                      10 = 10 pole,                      12 = 12 pole</p>		<p><b>Contact Type</b></p> <p>P = Pin,                      S = Socket</p>	<p><b>For PX0410 and PX0411 cable connectors - Cable Entry Size:</b></p> <p>3035 = 3.0 - 3.5mm (Light Grey)                      3540 = 3.5 - 4.0mm (Grey)                      4045 = 4.0 - 4.5mm (Green)                      4550 = 4.5 - 5.0mm (Red)</p> <p>5055 = 5.0 - 5.5mm (Yellow)                      5560 = 5.5 - 6.0mm (Blue)                      6065 = 6.0 - 6.5mm (White)                      6570 = 6.5 - 7.0mm (Black)</p> <p>Cable gland and collet supplied in colour coded pairs.</p> <p>For PX0413 PCB/Rear Panel Mount:                      PC = Pre-loaded PC pins                      Blank = no pins supplied</p> <p>For PX0412 Front Panel Mount:                      Suffix not required - leave blank</p>
<p><b>Examples:</b></p> <p>PX0410/10S/4045 = Flex cable connector, 10 socket contacts with gland and collet for cables between 4.0 and 4.5mm diameter (supplied less contacts).                      PX0412/08P = Front panel mounting connector, 8 pin contacts (supplied less contacts).                      PX0413/06P = Rear panel mounting connector, for 6 pin contacts (supplied less contacts).                      PX0413/04P/PC = Rear panel/PCB connector, 4 pin contacts, PCB mounting (supplied with contacts loaded).</p>					



- Sealed to IP66 IP68 and IP69K when mated
- IP68 rating tested at 1.054kg/sq cm (15lb/sq in) 10m depth for 2 weeks
- 3, 8 & 12 pole configuration
- Power ratings up to 13A, 600V
- Cable range from 3 to 7mm
- Diameter over coupling ring 19.7mm
- Flex, Flex In-Line, Rear Panel and PCB mounting body styles
- Colour coded O-rings & washers for easy identification purposes
- Plug and Socket versions in all body styles
- Flame Retardant moulding material - Polyamide UL94-V0
- Contacts supplied separately (except PCB versions)
- Sealing caps available to maintain IP68 rating
- Crimp and solder contacts
- UL, CSA and VDE approvals (pending)
- EN60068-2-52 Test Kb Salt Mist (Cyclic) Marine Severity Level 1
- EN60068-2-64 Vibration Resistance



Flex Cable Connector



PXP4010

- Mates with Flex In-line or Panel mounting versions PXP4011, PXP4013
- Pin or socket
- 3, 8, or 12 pole
- ¼ turn locking ring
- Contacts supplied separately

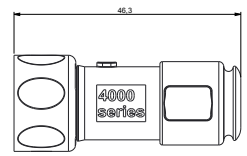
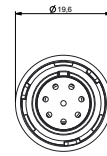

Inline Flex Cable Connector



PXP4011

- Mates with Flex Cable connector PXP4010
- Pin or socket
- 3, 8, or 12 pole
- For in-line cable connection
- Contacts supplied separately

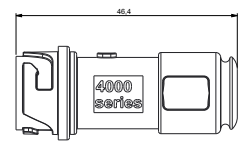

Rear Panel Mounting Connector



PXP4013

- Mates with Flex Cable connector PXP4010, PXP4011
- Rear Panel mounting
- Pin or socket
- Single hole fixing
- Contacts supplied separately
- 3, 8 or 12 pole

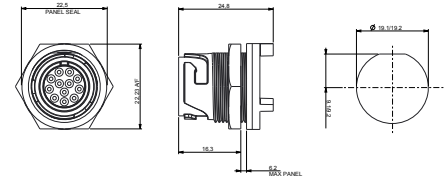

PCB Mounting Connector



PXP4013/XXX/PC

- Mates with Flex Cable connector PXP4010, PXP4011
- Pin or socket
- PCB Rear Panel mounting
- Straight PC spills
- Supplied with pre-loaded gold plated contacts
- 3, 8, or 12 pole

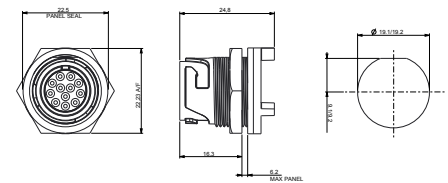

Sealing Caps and Accessories



PXP4081 PXP4082 PXP4083

- Maintains IP-sealed rating of unmated connectors

Part no.	Description
PXP4081	Sealing cap for use with PXP4010 & PXP4040
PXP4082	Sealing cap for use with PXP4011
PXP4083	Sealing cap for use with PXP4013 & PXP4043

Gland Packs



Part no.	Description
PXP4088/0305	Pack of 4 pairs cable glands and collets to suit cables from 3.0 to 5.0mm diameter.
PXP4088/0507	Pack of 4 pairs cable glands and collets to suit cables from 5.0 to 7.0mm diameter.

O-ring & washer pack



Part no.	Description
PXP4089/WH	White coloured O-ring and washer pack
PXP4089/RD	Red coloured O-ring and washer pack
PXP4089/BL	Blue coloured O-ring and washer pack
PXP4089/YL	Yellow coloured O-ring and washer pack
PXP4089/GN	Green coloured O-ring and washer pack

# BUCCANEER FOR POWER

## 4000 Series Buccaneer

Specifications



### Crimp Contacts

Pole	Current Rating	Pin	Socket	Pack Qty	Cable Acceptance (dia)
3	13A /*10A	SA3350	SA3349	10	16 - 18 AWG
8	8A /*4A	SA3348	SA3347	10	18 - 20 AWG
12	3A /*2A	SA3180	SA3179	10	22 - 24 AWG

### Solder Contacts

Pole	Current Rating	Pin	Socket	Pack Qty	Cable Acceptance (dia)
3	13A /*10A	SA3350/1	SA3349/1	10	16 - 18 AWG
8	8A /*4A	SA3348/1	SA3347/1	10	18 - 20 AWG
12	3A /*2A	SA3180/1	SA3179/1	10	22 - 24 AWG

### Insertion / Extraction

	Poles	Contact Rating	Colour	Part No
Insertion/Extraction Tool	3	13A /*10A	Blue	13027/2
Insertion/Extraction Tool	8	8A /*4A	Red	13027/1
Insertion/Extraction Tool	12	3A /*2A	Green	13027

### Crimp tools

	Poles	Contact Rating	Colour	Part No
Positioner	3	13A/*10A	Orange	14025/1618
Positioner	8	8A /*4A	Grey	14025/1820
Positioner	12	3A /*2A	Yellow	14025/2224
8 Indent Crimp Tool for use with positioners				14025

### PXP4013 PCB Contact Layout

#### Sockets

Contact numbers viewed from rear of panel

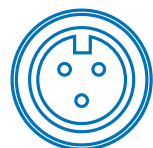
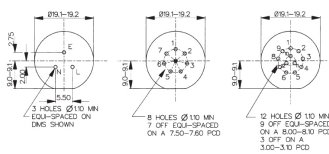

3 pole  
(13 Amp)

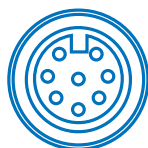

8 pole  
(8 Amp)

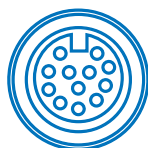

12 pole  
(3 Amp)

\*Current rating for CSA standards

#### Plugs

Contact numbers viewed from rear of panel

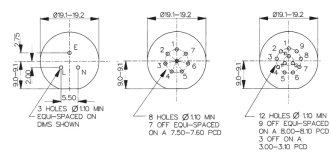

**Electrical:**

No. Poles:	3	8	12
Current Rating UL / VDE:	13A	8A	3A
Current Rating CSA:	10A	5A	3A
Voltage Rating (ac/dc):	600Vac/dc	600Vac/dc	600Vac/dc
Contact Resistance:	<5mΩ		
Insulation Resistance:	>10 <sup>6</sup> MΩ (@ 500V d.c.)		
AC Breakdown voltage:	2.5kV		

Operating Temperature:  
 Flex and panel types -40°C to +120°C

Approvals:

-  UL
-  CSA
-  VDE

**Material:**

Flex and panel types:  
 Body Mouldings: Polyamide  
 Flammability Rating: UL94V-0  
 UV Resistance: To EN 50021:1999

Contacts: Copper alloy, Gold plated

O Rings: Silicone

Panel Sealing O Ring: Silicone

**RoHS** Compliant

**Mechanical:**

Sealing: IP66 to En60529:1992+A2:2013  
 IP68 to En60529:1992+A2:2013 (10m depth for 2 weeks)  
 IP69k to DIN 40050-9

IP69K, Tested in accordance with DIN 40050/Part 9 IP6k9k

Salt Mist: EN60068-2-52 Test Kb Salt Mist (Cyclic) Marine Severity Level 1

Vibration: BS EN 60068-2-64:2008 Test Fh  
 BS EN 60068-2-27:2009 Test Ea

Cable Acceptance: 3.0 - 7.0mm

Contact Accommodation: 3 pole, 16 - 18 AWG  
 8 pole, 18 - 20 AWG  
 12 pole, 22 - 24 AWG

Termination: Crimp, solder and PCB

Insertion/Withdrawal Force:  
 No. poles: 3 8 12  
 Insertion Force (typ): 25N 28N 62N  
 Withdrawal Force (typ): 17N 22N 29N

Panel mount (PXP4013)  
 Front fixing nut: 1.0-1.1Nm (9lbf.in.)

Cable Retention force:  
 3.0mm dia 60N  
 4.0 to 7.0mm dia 80N

Panel thread PXP4013: 18.97x26TPI Whitworth form to BS84 med fit

**Dimensions:**

Overall dimensions of connectors when mated together

Flex + Flex In-Line 80mm  
 Dia. over coupling ring 19.7mm

<b>PXP40 xx</b>	<b>/</b>	<b>XX</b>	<b>X</b>	<b>/</b>	<b>XXXX</b>
<p><b>Body Styles</b></p> <p><b>PXP4010</b> = Flex body  <b>PXP4011</b> = Flex in-line body  <b>PXP4013</b> = Rear panel/PCB mounting body</p>		<p><b>Number Contacts</b></p> <p>03 = 3 pole,                      08 = 8 pole,                      12 = 12 pole,</p>	<p><b>Contact Type</b></p> <p><b>P</b> = Pin,  <b>S</b> = Socket</p>		<p><b>For PXP4010 and PXP4011 cable connectors</b>  <b>- Cable Entry Size:</b></p> <p>3035 = 3.0 - 3.5mm (Light Grey)                      3540 = 3.5 - 4.0mm (Grey)                      4045 = 4.0 - 4.5mm (Green)                      4550 = 4.5 - 5.0mm (Red)</p> <p>5055 = 5.0 - 5.5mm (Yellow)                      5560 = 5.5 - 6.0mm (Blue)                      6065 = 6.0 - 6.5mm (White)                      6570 = 6.5 - 7.0mm (Black)</p> <p>Cable gland and collet supplied in colour coded pairs.</p> <p>For PXP4013 PCB/Rear Panel Mount:                      PC = Pre-loaded PC pins                      Blank = no pins supplied</p>
<p><b>Examples:</b></p> <p><b>PXP4010/03S/4045</b> = Flex cable connector, 3 socket contacts with gland and collet for cables between 4.0 and 4.5mm diameter (supplied less contacts).  <b>PXP4013/08P</b> = Rear panel mounting connector, for 8 pin contacts (supplied less contacts).  <b>PXP4013/03P/PC</b> = Rear panel/PCB connector, 3 pin contacts, PCB mounting (supplied with contacts loaded).</p>					

6000 Series Buccaneer – circular connectors that combine the ease of use of a push/pull coupling mechanism with proven environmental sealing. Available with metal or plastic bodies, the range supports both data (USB and Ethernet), signal and mains power. Designed and independently tested to IP66, IP68 & IP69K standards, they are ideal for applications where ingress of dust and water must be avoided and where ease of connection, space and appearance are important considerations.

- Secure, quick connector mating and release
- 30° twist locking  
Tamperproof lock prevents accidental un-mating
- IP66, IP68 and IP69K when mated  
Suitable for a wide range of dust and water borne environments
- All plastic body version; UL94-V0 rated, UV stable, halogen free  
Light-weight, self-extinguishing material suitable for long-term outdoor use
- Flex, flex in-line & panel mount body styles, with sealing caps  
Complete family of products maintain sealing integrity in all styles
- Polarisation and visual alignment features  
Aids the correct mating of connectors
- 2 to 22 poles – up to 16A, 277V rated  
Suitable for mains power to signal applications
- ‘Scoop proof’ contacts  
Prevents damage through mis-mating – ideal for ‘blind mating’ applications
- cULus, UL, VDE  
Internationally recognised certification
- Screw, Crimp and Solder terminations available



BUCCANEER FOR POWER  
6000 Series Buccaneer

Thermo Plastic



Flex Cable Connector



PXP6010

- Mates with In-Line Flex or Panel Mounting versions PXP6011 & PXP6012
- Push/pull locking ring with 30° twist locking
- Pin or socket versions
- Leading earth on 3 pole connectors
- 2, 3, 8, 16 & 22 pole
- Screw, solder and crimp termination

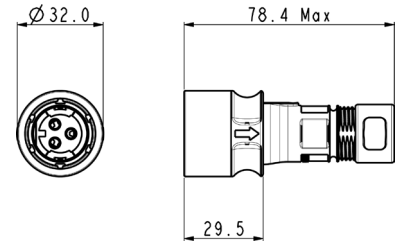

Poles	Termination	Pin Contacts	Socket Contacts	Contacts
2	Screw	PXP6010/02P/ST	PXP6010/02S/ST	Supplied Fitted
2	Crimp / Solder	PXP6010/02P/CR	PXP6010/02S/CR	Contacts Required
3	Screw	PXP6010/03P/ST	PXP6010/03S/ST	Supplied Fitted
3	Crimp / Solder	PXP6010/03P/CR	PXP6010/03S/CR	Contacts Required
8	Crimp / Solder	PXP6010/08P/CR	PXP6010/08S/CR	Contacts Required
16	Crimp / Solder	PXP6010/16P/CR	PXP6010/16S/CR	Contacts Required
22	Crimp / Solder	PXP6010/22P/CR	PXP6010/22S/CR	Contacts Required

In-line Flex Cable Connector



PXP6011

- Mates with Flex Cable connector PXP6010
- For in-line cable connection
- Pin or socket versions
- Leading earth on 3 pole connectors
- 2, 3, 8, 16 and 22 pole
- Screw, solder and crimp termination

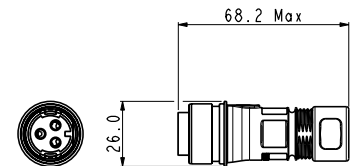

Poles	Termination	Pin Contacts	Socket Contacts	Contacts
2	Screw	PXP6011/02P/ST	PXP6011/02S/ST	Supplied Fitted
2	Crimp / Solder	PXP6011/02P/CR	PXP6011/02S/CR	Contacts Required
3	Screw	PXP6011/03P/ST	PXP6011/03S/ST	Supplied Fitted
3	Crimp / Solder	PXP6011/03P/CR	PXP6011/03S/CR	Contacts Required
8	Crimp / Solder	PXP6011/08P/CR	PXP6011/08S/CR	Contacts Required
16	Crimp / Solder	PXP6011/16P/CR	PXP6011/16S/CR	Contacts Required
22	Crimp / Solder	PXP6011/22P/CR	PXP6011/22S/CR	Contacts Required

Front Panel Mounting Connector



PXP6012

- Mates with Flex Cable connectors PXP6010
- Front panel mounting
- Single hole fixing
- Pin or socket versions
- Leading earth on 3 pole connectors
- 2, 3, 8, 16 and 22 pole
- Screw, solder and crimp termination

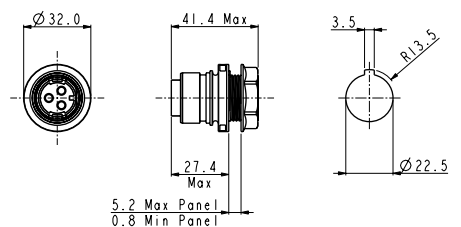

Poles	Termination	Pin Contacts	Socket Contacts	Contacts
2	Screw	PXP6012/02P/ST	PXP6012/02S/ST	Supplied Fitted
2	Crimp / Solder	PXP6012/02P/CR	PXP6012/02S/CR	Contacts Required
3	Screw	PXP6012/03P/ST	PXP6012/03S/ST	Supplied Fitted
3	Crimp / Solder	PXP6012/03P/CR	PXP6012/03S/CR	Contacts Required
8	Crimp / Solder	PXP6012/08P/CR	PXP6012/08S/CR	Contacts Required
16	Crimp / Solder	PXP6012/16P/CR	PXP6012/16S/CR	Contacts Required
22	Crimp / Solder	PXP6012/22P/CR	PXP6012/22S/CR	Contacts Required

BUCCANEER FOR POWER  
6000 Series Buccaneer

Metal Version



Flex Cable Connector



PXM6010

- Mates with In-Line Flex or Panel Mounting versions PXM6011 and PXM6012
- Push/pull locking ring with 30° twist locking
- Pin or socket versions
- Leading earth on 3 pole connectors
- 2, 3, 8, 16 and 22 pole
- Screw, solder and crimp termination
- Cable braid termination accessory option, add /SNSuffix

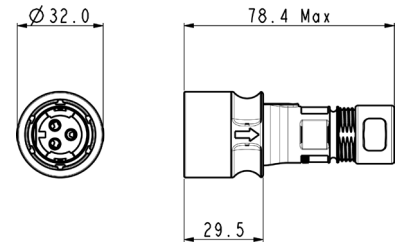

Poles	Termination	Pin Contacts	Socket Contacts	Contacts
2	Screw	PXM6010/02P/ST	PXM6010/02S/ST	Supplied Fitted
2	Crimp / Solder	PXM6010/02P/CR	PXM6010/02S/CR	Contacts Required
3	Screw	PXM6010/03P/ST	PXM6010/03S/ST	Supplied Fitted
3	Crimp / Solder	PXM6010/03P/CR	PXM6010/03S/CR	Contacts Required
8	Crimp / Solder	PXM6010/08P/CR	PXM6010/08S/CR	Contacts Required
16	Crimp / Solder	PXM6010/16P/CR	PXM6010/16S/CR	Contacts Required
22	Crimp / Solder	PXM6010/22P/CR	PXM6010/22S/CR	Contacts Required

In-line Flex Cable Connector



PXM6011

- Mates with Flex Cable connector PXM6010
- For in-line cable connection
- Pin or socket versions
- Leading earth on 3 pole connectors
- 2, 3, 8, 16 and 22 pole
- Screw, solder and crimp termination
- Cable braid termination accessory option, add /SNSuffix

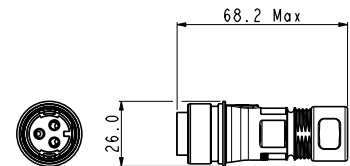

Poles	Termination	Pin Contacts	Socket Contacts	Contacts
2	Screw	PXM6011/02P/ST	PXM6011/02S/ST	Supplied Fitted
2	Crimp / Solder	PXM6011/02P/CR	PXM6011/02S/CR	Contacts Required
3	Screw	PXM6011/03P/ST	PXM6011/03S/ST	Supplied Fitted
3	Crimp / Solder	PXM6011/03P/CR	PXM6011/03S/CR	Contacts Required
8	Crimp / Solder	PXM6011/08P/CR	PXM6011/08S/CR	Contacts Required
16	Crimp / Solder	PXM6011/16P/CR	PXM6011/16S/CR	Contacts Required
22	Crimp / Solder	PXM6011/22P/CR	PXM6011/22S/CR	Contacts Required

Front Panel Mounting Connector



PXM6012

- Mates with Flex Cable connectors PXM6010
- Front panel mounting
- Single hole fixing
- Pin or socket versions
- Leading earth on 3 pole connectors
- 2, 3, 8, 16 and 22 pole
- Screw, solder and crimp termination

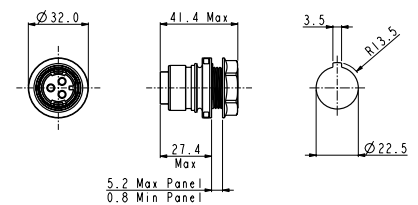



Poles	Termination	Pin Contacts	Socket Contacts	Contacts
2	Screw	PXM6012/02P/ST	PXM6012/02S/ST	Supplied Fitted
2	Crimp / Solder	PXM6012/02P/CR	PXM6012/02S/CR	Contacts Required
3	Screw	PXM6012/03P/ST	PXM6012/03S/ST	Supplied Fitted
3	Crimp / Solder	PXM6012/03P/CR	PXM6012/03S/CR	Contacts Required
8	Crimp / Solder	PXM6012/08P/CR	PXM6012/08S/CR	Contacts Required
16	Crimp / Solder	PXM6012/16P/CR	PXM6012/16S/CR	Contacts Required
22	Crimp / Solder	PXM6012/22P/CR	PXM6012/22S/CR	Contacts Required



Crimp / Solder Contacts			Contacts (for 2 & 3 pole) (Supplied in packs of 10)	Crimp	Solder
 <p>2, 3, 8, 16 &amp; 22 pole contacts</p>	<ul style="list-style-type: none"> <li>○ Gold Plated</li> <li>○ Current ratings: 2 &amp; 3 pole : 16A 8 pole : 10A 16 pole : 3A 22 pole : 2A</li> </ul>		Pins Sockets	SA3545/P SA3545/S	SA3624/P SA3624/S
			Contacts (for 8 pole) (Supplied in packs of 10)	Crimp	Solder
			Pins Sockets	SA3544/P SA3544/S	SA3623/P SA3623/S
			Contacts (for 16 & 22 pole) (Supplied in packs of 10)	Crimp	Solder
			Pins Sockets	SA3542/P SA3542/S	SA3622/P SA3622/S

Crimp Tooling			Crimp Tooling	
 <p>PNo 14232</p>	<ul style="list-style-type: none"> <li>○ Crimp Tools for 2, 3, 8, 16 and 22 pole crimp contacts</li> </ul>		Crimp Tool (2 & 3 pole) Positioner (2 & 3 pole) Crimp Tool (8, 16 & 22 pole) Positioner (8 pole) Positioner (16 & 22 pole)	PNo.14232 PNo.14232/2/SP PNo.14025 PNo.15021/SP PNo.15019/SP

Extraction Tool			Extraction Tools	
	<ul style="list-style-type: none"> <li>○ Extraction Tool for 2, 3, 8, 16 and 22 pole contacts</li> </ul>		Extraction Tool (2 & 3 pole)	PNo.14946/SP
			Extraction Tool (8 pole)	PNo.14945/SP
			Extraction Tool (16 & 22 pole)	PNo.14944/SP

Contact Carrier Removal Tool			Tools	
 <p>PNo 14917</p>	<ul style="list-style-type: none"> <li>○ For removal of all contact carriers</li> </ul>		Contact carrier removal tool (all poles)	PNo. 14917/SP

Sealing Caps



PXM6083 PXM6082 PXM6081

- Maintains IP Rating of Unmated Connectors
- PXM6081: Fits PXM6010 (Flex Connector)
- PXM6082: Fits PXM6011 (Flex In-Line Connector)
- PXM6083: Fits PXM6012 (Panel Connector)

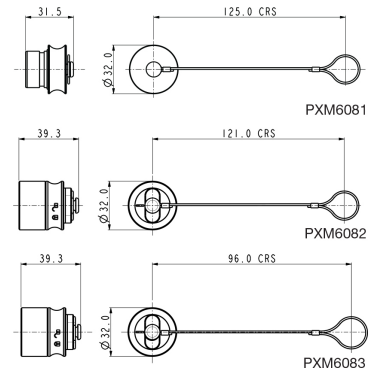

Plastic Sealing Caps



PXP6083 PXP6082 PXP6081

- Maintains IP Rating of Unmated Connectors
- PXP6081: Fits PXP6010 (Flex Connector)
- PXP6082: Fits PXP6011 (Flex In-Line Connector)
- PXP6083: Fits PXP6012 (Panel Connector)

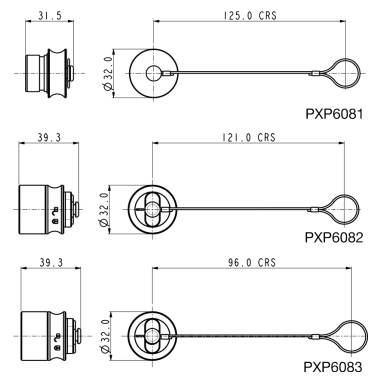

Cable Gland Pack



PXP6088

- Pack of all cable glands to suit cable ranges from 4.0 to 10.0mm diameter

Cable Braid Termination Option



PXM6090

- For cable braid termination
- Supplied with ty-rap

BUCCANEER FOR POWER  
**6000 Series Buccaneer**

Part No System



<b>PXX</b>	<b>6XXX</b>	<b>/</b>	<b>XX</b>	<b>/</b>	<b>X</b>	<b>/</b>	<b>XX</b>	<b>/</b>	<b>XXXX</b>	<b>/</b>	<b>XX</b>
<b>Series Designation</b>	<b>Series / Body Style</b>		<b>No. of Contacts</b>		<b>Contacts Type</b>		<b>Terminations</b>		<b>Cable Entry Size</b>		<b>Cable Brand Termination Accessory</b>
PXM= Metal Series PXP= Plastic Series	Body Styles 6010 = Flex 6011 = Flex In-Line 6012 = Panel		No. of Contacts 02 = 2 Pole 03 = 3 Pole 08 = 8 Pole 16 = 16 Pole 22 = 22 Pole		Contacts Type P = Pin S = Socket		Contacts Termination CR = Contacts Required ST = Screw (2 and 3 pole only)		Cable Entry Size (for Flex and Flex In-Line connectors only)  0405 = 4-5mm (Dark Grey)  0507 = 5-7mm (White)  0709 = 7-9mm (Yellow)  0910 = 9-10mm (Light Grey)		Cable Braid Termination Accessory (for Flex and Flex In-Line connectors only) SN if required Blank if not required

**Examples**

PXM6010/03P/CR/0507= Flex cable connector, 3 pole, pin contacts with 5 to 7mm cable glands  
 PXM6012/03/S/ST= Front panel mounting connector, 3 pole, socket with screw termination

# BUCCANEER FOR POWER

## 6000 Series Buccaneer

Specifications



### Electrical:

No. Poles:	2	3	8	16	22
Current Rating: See de-rating curves for further information					
VDE	16A	16A	10A	3A	2A
UL	16A	16A	7A	3A	3A
cUL	11A	11A	4A	1.5A	1.5A
CCC					
Voltage	277V	277V	277V	60V	60V
Rated cable	18 AWG	18 AWG	18 AWG	22 AWG	26 AWG
Contact Resistance:	<10mΩ				
Insulation Resistance:	>10 <sup>6</sup> MΩ @500V dc				
AC Breakdown voltage:					
2 pole	>10kV				
3 pole	>8kV				
8 to 22 pole	>5kV				
Operating Temp. Range:	-40°C to +120°C				
Approvals:					
UL (E214972)	UL1977				
cULus (E214972)	C22.2 No.182.3-M1987 (R2009)				
VDE (40039281)	IEC 61984:2009				
CCC (Pending)					

### Mechanical:

Locking mechanism	Push/pull with 30° locking Patent applied for
Sealing:	IP66 to En60529:1992+A2:2013 IP68 to En60529:1992+A2:2013 (10m depth for 2 weeks) IP69k to DIN 40050-9
Salt Mist (plastic) :	EN60068-2-52 Test Kb Salt Mist (Cyclic) Marine Severity Level 1
Salt Mist (metal) :	EN60068-2-11 Test Ka Salt Mist
Contact Accommodation:	
2 & 3 pole crimp / solder	14 to 18AWG
2 & 3 pole screw terminals	1.5mm <sup>2</sup> max
8 pole crimp / solder	18 to 20AWG
16 pole crimp / solder	22 to 26AWG
22 pole crimp / solder	22 to 26AWG
Cable Acceptance:	4-10mm dia.
Cable retention force (to BS EN61984):	
4 - 9mm dia cable	80N
9 - 10mm dia cable	100N
Terminations:	
2 Pole:	Screw Terminals
3 Pole:	Screw, crimp or solder terminals
8 Pole:	Crimp / Solder Contacts
16 Pole:	Crimp / Solder Contacts
22 Pole:	Crimp / Solder Contacts
Tightening Torques:	
Gland Nut:	1.13Nm (10lb.in)
Panel Nut:	1.7Nm (15lb.in.)
Panel Nut Thread:	M22 x 1.5-6g
Dimensions:	
Diameter: (over coupling ring)	32mm
Diameter: (panel hole cut-out)	22.5mm

### Materials:

	Plastic	Metal
Body:	PC/ PBT	Brass
Colour:	Grey	Matt silver
Contacts:	Brass, Nickel Plate (Screw and Crimp) Brass, (3A – Gold plated)	Brass, Nickel Plate (Screw and Crimp) Brass, (3A – Gold plated)
O Rings & Gaskets:	Silicone	Silicone
Flammability Rating:	UL94 V-0	-
Halogen free	Yes	-
UV Resistance:	ISO 4892 part 3 cycle 1 (QUV)	-
<b>RoHS</b>	Compliant	Compliant

The thermal properties of the materials used in the construction of a connector limit the current carrying capacity. There are a number of factors that determine the amount of current that can be handled: contact spacing, size of cable, ambient temperature and the heat that is generated by the current passing through the connector.

The maximum current varies with different contact layouts, and because of these factors it is necessary to produce de-rating curves for each pole variant. This de-rating curve is specified in the standard IEC 60512 part 3. De-rating curves are plotted for each contact carrier combination with the current being carried simultaneously by all contacts. These graphs show the heat rise generated as the current is increased.

The red line indicates the direct correlation between current applied and the measured temperature rise within the connector. The dotted blue line shows rated current and the green line is derived by applying a factor of 0.8 to the original plot data to give a de-rating curve. The shaded area shows the permitted operating area, and allows safe current vs ambient temperature characteristics to be determined.

The shaded area under the 0.8 curve shows the permitted operating area, and allows safe current vs ambient temperature characteristics to be determined.

- = tested operating limits
- = de-rated operating limits
- - - = rated current

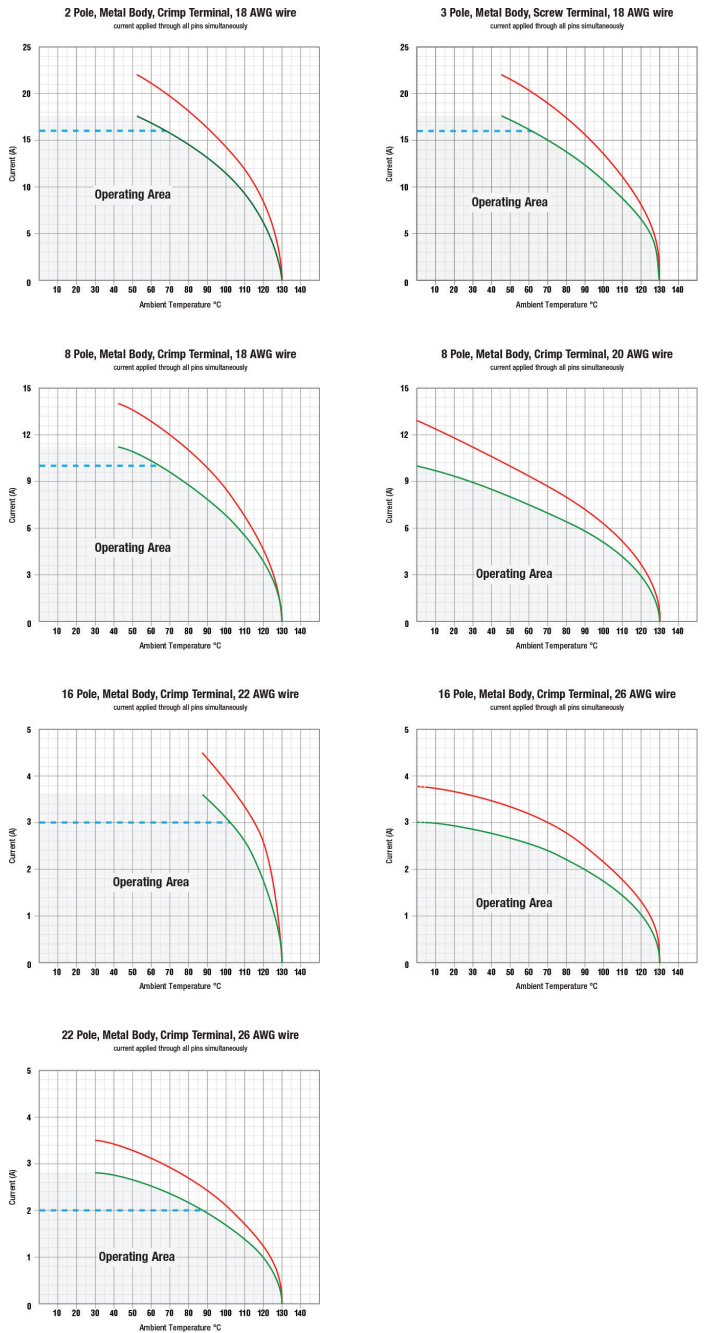

The all plastic and metal construction of the 7000 Series Buccaneer - **circular connectors** that combine the ease of use of a **quick** coupling mechanism with **proven** environmental sealing for signal and mains **power**.

Designed and independently tested to IP66, IP68 & IP69K standards, they are ideal for applications where ingress of dust and water must be avoided and where ease of connection, space and appearance are important considerations.

- **Less than 1/4 Turn locking mechanism**  
Secure, quick connector mating and release
- **Positive feedback on locking mechanism**  
Confidence that connector is correctly mated and sealed
- **IP66, IP68 and IP69K when mated**  
Suitable for a wide range of dust and water borne environments
- **All plastic body version; UL94-V0 rated, UV stable, halogen free**  
Light-weight, self-extinguishing material suitable for long-term outdoor use
- **Flex, flex in-line & panel mount body styles, with sealing caps**  
Complete family of products maintain sealing integrity in all styles
- **Polarisation and visual alignment features**  
Aids the correct mating of connectors
- **2 to 32 poles – up to 25A, 600V rated**  
Suitable for mains power to signal applications
- **'Scoop proof' contacts**  
Prevents damage through mis-mating – ideal for 'blind mating' applications
- **cULs, UL, VDE**  
approvals Internationally recognised certification (pending)
- **Screw, Crimp and Solder terminations available**
- **EN60068-2-52 Test Kb Salt Mist (Cyclic)**  
Marine Severity Level 1



# BUCCANEER FOR POWER

## 7000 Series Buccaneer

Thermo Plastic



### Flex Cable Connector



PXP7010

- Mates with In-Line Flex or Panel Mounting versions PXP7011 & PXP7012
- Quick turn locking ring
- Pin or socket versions
- Leading earth on 3 pole connectors
- 2, 3, 6, 10 & 32 pole
- Screw solder and crimp termination

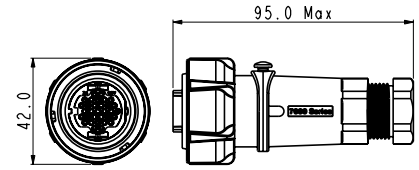

Poles	Termination	Pin Contacts	Socket Contacts	Contacts
2	Screw	PXP7010/02P/ST	PXP7010/02S/ST	Supplied Fitted
3	Screw	PXP7010/03P/ST	PXP7010/03S/ST	Supplied Fitted
6	Screw	PXP7010/06P/ST	PXP7010/06S/ST	Supplied Fitted
10	Crimp / Solder	PXP7010/10P/CR	PXP7010/10S/CR	Contact Required
32	Crimp / Solder	PXP7010/32P/CR	PXP7010/32S/CR	Contact Required

### In-line Flex Cable Connector



PXP7011

- Mates with Flex Cable connector PXP7010
- For in-line cable connection
- Pin or socket versions
- Leading earth on 3 pole connectors
- 2, 3, 6, 10 and 32 pole
- Screw solder and crimp termination

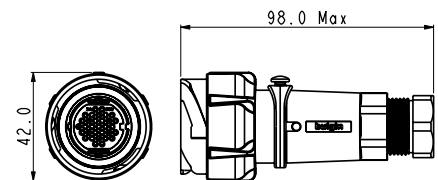

Poles	Termination	Pin Contacts	Socket Contacts	Contacts
2	Screw	PXP7011/02P/ST	PXP7011/02S/ST	Supplied Fitted
3	Screw	PXP7011/03P/ST	PXP7011/03S/ST	Supplied Fitted
6	Screw	PXP7011/06P/ST	PXP7011/06S/ST	Supplied Fitted
10	Crimp / Solder	PXP7011/10P/CR	PXP7011/10S/CR	Contact Required
32	Crimp / Solder	PXP7011/32P/CR	PXP7011/32S/CR	Contact Required

### Front Panel Mounting Connector



PXP7012

- Mates with Flex Cable connectors PXP7010
- Front panel mounting
- Single hole fixing
- Pin or socket versions
- Leading earth on 3 pole connectors
- 2, 3, 6, 10 and 32 pole
- Screw solder and crimp termination

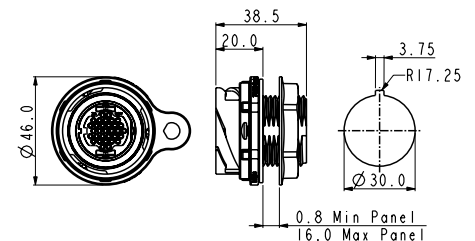

Poles	Termination	Pin Contacts	Socket Contacts	Contacts
2	Screw	PXP7012/02P/ST	PXP7012/02S/ST	Supplied Fitted
3	Screw	PXP7012/03P/ST	PXP7012/03S/ST	Supplied Fitted
6	Screw	PXP7012/06P/ST	PXP7012/06S/ST	Supplied Fitted
10	Crimp / Solder	PXP7012/10P/CR	PXP7012/10S/CR	Contact Required
32	Crimp / Solder	PXP7012/32P/CR	PXP7012/32S/CR	Contact Required

BUCCANEER FOR POWER  
7000 Series Buccaneer

Metal Version



Flex Cable Connector



PXM7010

- Mates with In-Line Flex or Panel Mounting versions PXM7011 & PXM7012
- Quick turn locking ring
- Pin or socket versions
- Leading earth on 3 pole connectors
- 2, 3, 6, 10 & 32 pole
- Screw solder and crimp termination
- Cable braid termination accessory option, add /SNSuffix

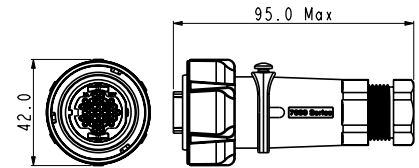

Poles	Termination	Pin Contacts	Socket Contacts	Contacts
2	Screw	PXM7010/02P/ST	PXM7010/02S/ST	Supplied Fitted
3	Screw	PXM7010/03P/ST	PXM7010/03S/ST	Supplied Fitted
6	Screw	PXM7010/06P/ST	PXM7010/06S/ST	Supplied Fitted
10	Crimp / Solder	PXM7010/10P/CR	PXM7010/10S/CR	Contact Required
32	Crimp / Solder	PXM7010/32P/CR	PXM7010/32S/CR	Contact Required

In-line Flex Cable Connector



PXM7011

- Mates with Flex Cable connector PXM7010
- For in-line cable connection
- Pin or socket versions
- Leading earth on 3 pole connectors
- 2, 3, 6, 10 and 32 pole
- Screw solder and crimp termination
- Cable braid termination accessory option, add /SNSuffix

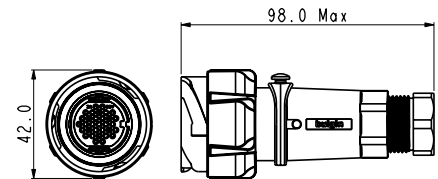

Poles	Termination	Pin Contacts	Socket Contacts	Contacts
2	Screw	PXM7011/02P/ST	PXM7011/02S/ST	Supplied Fitted
3	Screw	PXM7011/03P/ST	PXM7011/03S/ST	Supplied Fitted
6	Screw	PXM7011/06P/ST	PXM7011/06S/ST	Supplied Fitted
10	Crimp / Solder	PXM7011/10P/CR	PXM7011/10S/CR	Contact Required
32	Crimp / Solder	PXM7011/32P/CR	PXM7011/32S/CR	Contact Required

Front Panel Mounting Connector





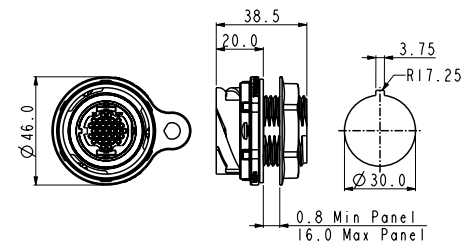

PXM7012

- Mates with Flex Cable connectors PXM7010
- Front panel mounting
- Single hole fixing
- Pin or socket versions
- Leading earth on 3 pole connectors
- 2, 3, 6, 10 and 32 pole
- Screw solder and crimp termination



Poles	Termination	Pin Contacts	Socket Contacts	Contacts
2	Screw	PXM7012/02P/ST	PXM7012/02S/ST	Supplied Fitted
3	Screw	PXM7012/03P/ST	PXM7012/03S/ST	Supplied Fitted
6	Screw	PXM7012/06P/ST	PXM7012/06S/ST	Supplied Fitted
10	Crimp / Solder	PXM7012/10P/CR	PXM7012/10S/CR	Contact Required
32	Crimp / Solder	PXM7012/32P/CR	PXM7012/32S/CR	Contact Required

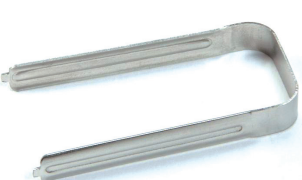

<p>Crimp / Solder Contacts</p>  <p>10 &amp; 32 pole contacts</p>	<ul style="list-style-type: none"> <li>○ Gold Plated</li> <li>○ Current ratings: 10 pole: 10A 32 pole: 2A</li> </ul>	<table border="0"> <tr> <td><b>Contacts (for 10 pole) (Supplied in packs of 10)</b></td> <td><b>Crimp</b></td> <td><b>Solder</b></td> </tr> <tr> <td>Pins</td> <td>SA3544/P</td> <td>SA3623/P</td> </tr> <tr> <td>Sockets</td> <td>SA3544/S</td> <td>SA3623/S</td> </tr> <tr> <td><b>Contacts (for 32 pole) (Supplied in packs of 10)</b></td> <td><b>Crimp</b></td> <td><b>Solder</b></td> </tr> <tr> <td>Pins</td> <td>SA3542/P</td> <td>SA3622/P</td> </tr> <tr> <td>Sockets</td> <td>SA3542/S</td> <td>SA3622/S</td> </tr> </table>	<b>Contacts (for 10 pole) (Supplied in packs of 10)</b>	<b>Crimp</b>	<b>Solder</b>	Pins	SA3544/P	SA3623/P	Sockets	SA3544/S	SA3623/S	<b>Contacts (for 32 pole) (Supplied in packs of 10)</b>	<b>Crimp</b>	<b>Solder</b>	Pins	SA3542/P	SA3622/P	Sockets	SA3542/S	SA3622/S
<b>Contacts (for 10 pole) (Supplied in packs of 10)</b>	<b>Crimp</b>	<b>Solder</b>																		
Pins	SA3544/P	SA3623/P																		
Sockets	SA3544/S	SA3623/S																		
<b>Contacts (for 32 pole) (Supplied in packs of 10)</b>	<b>Crimp</b>	<b>Solder</b>																		
Pins	SA3542/P	SA3622/P																		
Sockets	SA3542/S	SA3622/S																		
<p>Crimp Tooling</p>  <p>PNo 14025</p>	<ul style="list-style-type: none"> <li>○ Crimp Tools for 10 and 32 pole crimp contacts</li> </ul>	<p><b>Crimp Tooling</b></p> <table border="0"> <tr> <td>Crimp Tool (10 &amp; 32 pole)</td> <td>PNo. 14025</td> </tr> <tr> <td>Positioner (10 pole)</td> <td>PNo. 15021/SP</td> </tr> <tr> <td>Positioner (32 pole)</td> <td>PNo. 15019/SP</td> </tr> </table>	Crimp Tool (10 & 32 pole)	PNo. 14025	Positioner (10 pole)	PNo. 15021/SP	Positioner (32 pole)	PNo. 15019/SP												
Crimp Tool (10 & 32 pole)	PNo. 14025																			
Positioner (10 pole)	PNo. 15021/SP																			
Positioner (32 pole)	PNo. 15019/SP																			
<p>Extraction Tools</p>  <p>PNo 14944/SP PNo 14945/SP</p>	<ul style="list-style-type: none"> <li>○ Extraction tool for 10 and 32 pole contacts</li> </ul>	<p><b>Extraction Tools</b></p> <table border="0"> <tr> <td>Extraction tool (10 pole)</td> <td>PNo. 14945/SP</td> </tr> <tr> <td>Extraction tool (32 pole)</td> <td>PNo. 14944/SP</td> </tr> </table>	Extraction tool (10 pole)	PNo. 14945/SP	Extraction tool (32 pole)	PNo. 14944/SP														
Extraction tool (10 pole)	PNo. 14945/SP																			
Extraction tool (32 pole)	PNo. 14944/SP																			
<p>Contact Carrier Removal Tool</p>  <p>PNo 15065/SP</p>	<ul style="list-style-type: none"> <li>○ For removal of all contact carriers</li> </ul>	<p><b>Contact Carrier Removal Tool</b></p> <table border="0"> <tr> <td>Contact carrier removal tool (all poles)</td> <td>PNo. 15065/SP</td> </tr> </table>	Contact carrier removal tool (all poles)	PNo. 15065/SP																
Contact carrier removal tool (all poles)	PNo. 15065/SP																			
<p>Cable Braid Termination Option</p>  <p>PXM7090</p>	<ul style="list-style-type: none"> <li>○ For cable braid termination</li> <li>○ Supplied with ty-rap</li> </ul>																			

Sealing Caps



PXP7082 PXP7081

- Maintains IP rating of unmated connectors
- PXP7081: Fits PXP7010 (Flex Connector)
- PXP7082: Fits PXP7011 (FlexIn-Line Connector) and PXP7012: (Panel Connector)

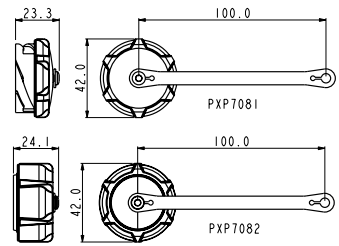

Sealing Caps



PXM7082 PXM7081 PXM7083

- Maintains IP rating of unmated connectors
- PXM7081: Fits PXM7010 (FlexConnector)
- PXM7082: Fits PXM7011 (Flex In-Line Connector) and PXP7012: (Panel Connector)
- PXM7083: Fits PXM7012 (Panel Mounting Connector)

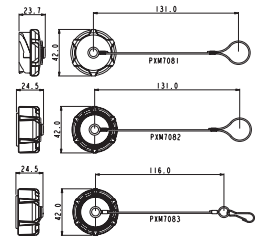

Cable Gland Packs



PXP7088/ \*

- Packs of cable glands, cages and gland nuts to suit cables ranges from 5.0 to 15.0mm diameter
- PXP7088/0507: for cable ranges between 5.0 and 7.0mm
- PXP7088/0713: for cable ranges between 7.0 and 13.0mm
- PXP7088/1315: for cable ranges between 13.0 and 15.0mm

BUCCANEER FOR POWER  
**7000 Series Buccaneer**

Part No System



<b>PXX</b>	<b>7XXX</b>	<b>/</b>	<b>XX</b>	<b>X</b>	<b>/</b>	<b>XX</b>	<b>/</b>	<b>XXXX</b>	<b>/</b>	<b>XX</b>
<b>Series Designation</b>	<b>Series / Body Style</b>	<b>No. of Contacts</b>	<b>Contacts Type</b>	<b>Terminations</b>	<b>Cable Entry Size</b>	<b>Cable Brand Termination Accessory</b>				
PXM= Metal Series PXP= Plastic Series	7010 = Flex 7011 = Flex In-Line 7012 = Panel	02 = 2 Pole 03 = 3 Pole 06 = 6 Pole 10 = 10 Pole 32 = 32 Pole	P = Pin S = Socket	ST = Screw Terminal (2, 3, & 6 pole only) CR = Contacts Required (10 & 32 pole only)	(for Flex and Flex In-Line connectors only) 0507 = 5-7mm (grey) 0709 = 7-9mm (white) 0911 = 9-11mm (black) 1113 = 11 to 13 mm (yellow) 1315 = 13 to 15 mm (light grey)	(for Flex and Flex In-Line connectors only) SN - If requires Blank - If not required				

**Examples**

PXM7010/10/P/CR/0911/SN= Flex cable connector, 10 pole, pin contacts with 9 to 11mm cable glands and braid termination accessory





PXM7012/03/S/ST= Front panel mounting connector, 3 pole, socket with screw termination

BUCCANEER FOR POWER  
7000 Series Buccaneer

Specifications



**Electrical:**

No Poles:	2	3	6	10	32
Current Rating:					
CCC, UL and VDE	25A	25A	10A	10A	3A
cUL (pending)	25A	25A	8A	6A	2A
Voltage Rating (ac/dc):					
CCC, VDE (pending)	600V	600V	500V	277V	200V
UL, cUL (pending)	600V	600V	600V	600V	600V
Contact Resistance:	<10mΩ				
Insulation Resistance:	>10 <sup>9</sup> MΩ @500V dc				
AC Breakdown voltage:					
2 pole	>10kV				
3 pole	>8kV				
6 to 32 pole	>5kV				
Operating Temp. Range:	-40°C to +120°C				
Approvals (pending):					
 UL (Pending)	UL1977				
 cULus (Pending)	C22.2 No.182.3-M1987 (R2009)				
 VDE (Pending)	IEC 61984:2009				
 CCC (Pending)	GB/T11918 and GB/T11919				

**Mechanical:**

Locking mechanism	Quarter turn, rapid locking
Sealing:	IP66 to EN60529:1992+A2:2013 IP68 to EN60529:1992+A2:2013 (10m depth for 2 weeks) IP69k to DIN 40050-9
Salt Mist (plastic):	EN60068-2-52 Test Kb Salt Mist (Cyclic) Marine Severity Level 1
Salt Mist (metal):	EN60068-2-11 Test Ka Salt Mist
Contact Accommodation:	
2 & 3 pole screw terminals	6.0mm <sup>2</sup> max
6 pole screw	1.00mm <sup>2</sup> max
10 pole crimp / solder	18 to 20AWG
32 pole crimp / solder	22 to 26AWG
Cable Acceptance:	5-15mm dia.
Cable retention force (to BS EN61984):	
5 - 9mm dia cable	80N
9 - 15mm dia cable	100N
Terminations	
2 Pole:	Screw Terminals
3 Pole:	Screw Terminals
6 Pole:	Screw Terminals
10 Pole:	Crimp / Solder Contacts
32 Pole:	Crimp / Solder Contacts
Tightening Torques:	
Gland Nut:	TBA
Panel Nut:	1.7Nm (15lb.in.)
Panel Nut Thread	M30 x 2-6g
Dimensions:	
Diameter: (over coupling ring)	42mm
Diameter: (panel hole cut-out)	30mm

**Materials:**

**Plastic**

**Metal**

Body:	PC/ PBT	Cast zinc alloy, nickel plated
Colour:	Grey	Matt silver
Contacts:	Brass, Nickel Plate (Screw and Crimp) Brass, (3A – Gold plated)	Brass, Nickel Plate (Screw and Crimp) Brass, (3A – Gold plated)
O Rings & Gaskets:	Silicone	Silicone
Flammability Rating:	UL94 V-0	-
Halogen free	Yes	-
UV Resistance:	ISO 4892 part 3 cycle 1 (QUV)	-
<b>RoHS</b>	Compliant	Compliant

The thermal properties of the materials used in the construction of a connector limit the current carrying capacity. There are a number of factors that determine the amount of current that can be handled: contact spacing, size of cable, ambient temperature and the heat that is generated by the current passing through the connector.

The maximum current varies with different contact layouts, and because of these factors it is necessary to produce de-rating curves for each pole variant. This de-rating curve is specified in the standard IEC 60512 part 3. De-rating curves are plotted for each contact carrier combination with the current being carried simultaneously by all contacts. These graphs show the heat rise generated as the current is increased.

The red line indicates the direct correlation between current applied and the measured temperature rise within the connector. The dotted blue line shows rated current and the green line is derived by applying a factor of 0.8 to the original plot data to give a de-rating curve. The dashed blue line shows the rated current.

The shaded area under the 0.8 curve shows the permitted operating area, and allows safe current vs ambient temperature characteristics to be determined.

- = tested operating limits
- = de-rated operating limits
- - - = rated current

7000 Series Current vs. Temperature Characteristics

2 Pole, Plastic Body, Screw Terminal, 6.0mm<sup>2</sup> wire  
current applied through all pins simultaneously

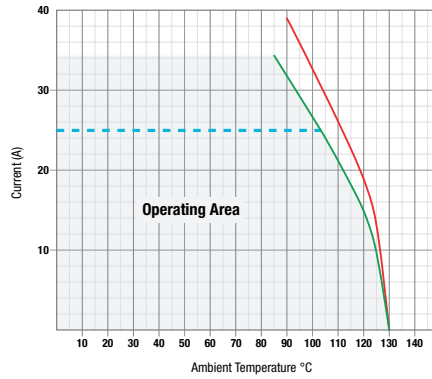

7000 Series Current vs. Temperature Characteristics

3 Pole, Plastic Body, Screw Terminal, 4.0mm<sup>2</sup> wire  
current applied through all pins simultaneously

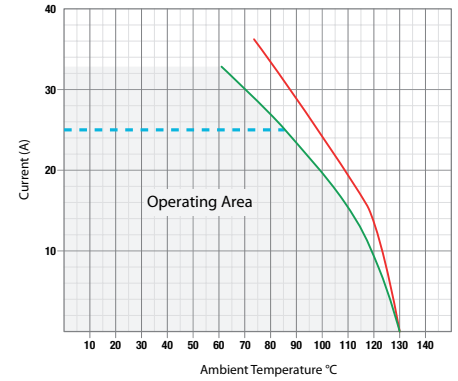

7000 Series Current vs. Temperature Characteristics

6 Pole, Plastic Body, Screw Terminal, 1.0mm<sup>2</sup> wire  
current applied through all pins simultaneously

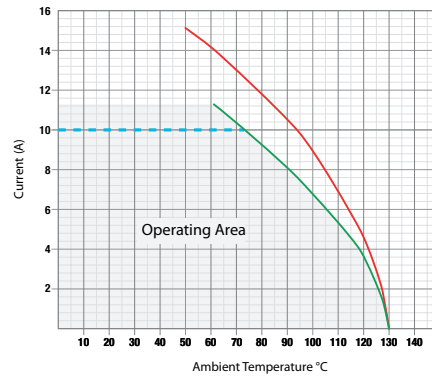

7000 Series Current vs. Temperature Characteristics

10 Pole, Plastic Body, Crimp Terminal, 18 AWG wire  
current applied through all pins simultaneously

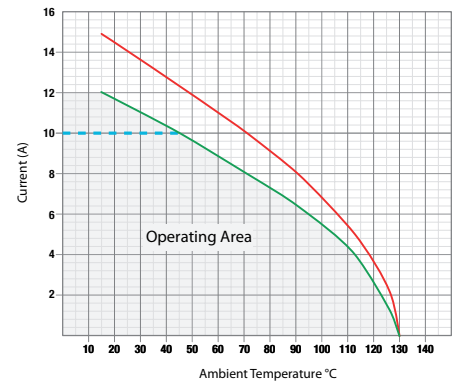

7000 Series Current vs. Temperature Characteristics

32 Pole, Plastic Body, Crimp Terminal, 22 AWG wire  
current applied through all pins simultaneously

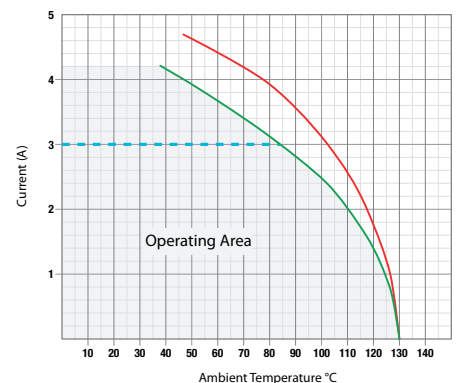

A full range of IP68 rated environmentally sealed circular connectors designed to provide secure and safe connections in harsh or hostile conditions.

The Data Buccaneer range now includes designs specifically for Ethernet, USB and SMB applications. Ethernet Buccaneer meets Cat 5e requirements for data rates up to 100Mbps, USB Buccaneer is designed to meet USB version 2.0 specification for data rates up to 480Mbps, SMB Buccaneer has a frequency response up to 4GHz.

The Buccaneer series finds numerous applications either in external or internal environments where protection against the ingress of dust and moisture is a system requirement.



Standard Buccaneer - Ethernet	63-68
Standard Buccaneer - USB	69-74
400 Series - Mini USB Buccaneer	75-79
400 Series - SMB Buccaneer	80-82
400 Series - Wireless Buccaneer	83-89
4000 Series - Micro USB	90-92
6000 Series Buccaneer - USB	93-98
6000 Series Buccaneer - Ethernet	99-103

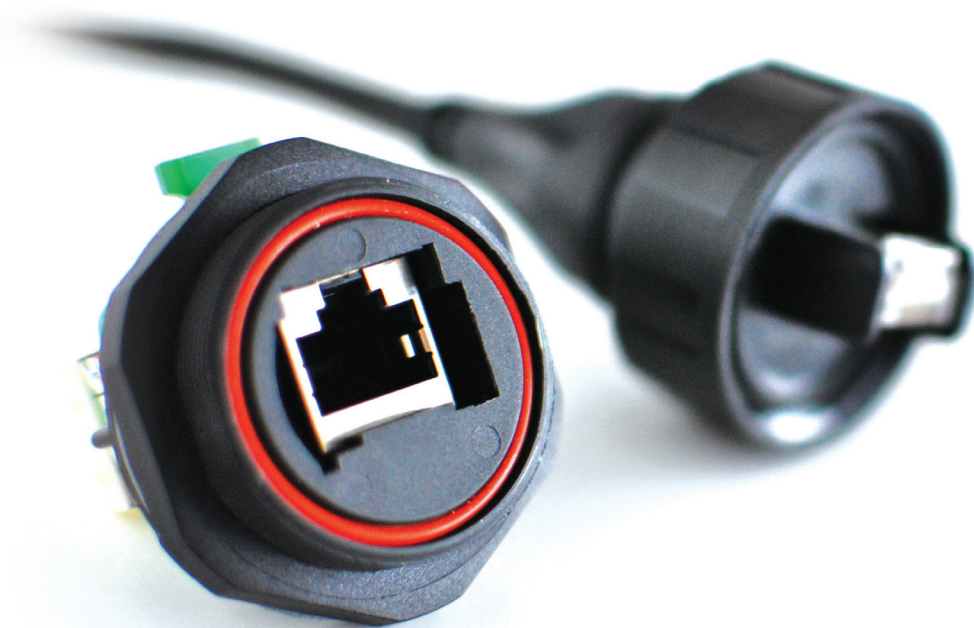

- ⊗ IP68 rated
- ⊗ IP69K, Tested in accordance with DIN 40050/Part 9 IP6k9k
- ⊗ Cat 5e compliant
- ⊗ PUR jacket on cable
- ⊗ Shielded system
- ⊗ Cat 5e shielded coupler
- ⊗ Shroud on RJ45
- ⊗ Screw coupling
- ⊗ Rewireable flex connector
- ⊗ PCB mounted panel connector
- ⊗ IDC termination panel connector
- ⊗ Earth lead version of panel adaptor
- ⊗ EN60068-2-52 Test Kb Salt Mist (Cyclic) Marine Severity Level 1
- ⊗ Dust and waterproof sealing when mated
- ⊗ Data rate up to 100MHz
- ⊗ Good chemical resistance, flame retardant
- ⊗ High noise immunity and EMI protection
- ⊗ Maintains shielding
- ⊗ Protection from abuse and mis-mating
- ⊗ Secure, proven locking system
- ⊗ Ability to 'field' terminate
- ⊗ Direct PCB mount panel connector
- ⊗ Simple termination
- ⊗ Continuous screening of panel mount connector

Patch Cord Flex Connector - PUR Jacket



PX0836

- Mates with all panel mounting connectors
- Patchcords with IP68 connector
- Supplied with shielded RJ45 plug
- Single or double end terminated
- Standard lengths: 2m, 3m & 5m
- S-FTP cable construction
- PUR jacket cable
- Wiring configuration to 568-B
- Exceeds EIA/TIA Cat 5e

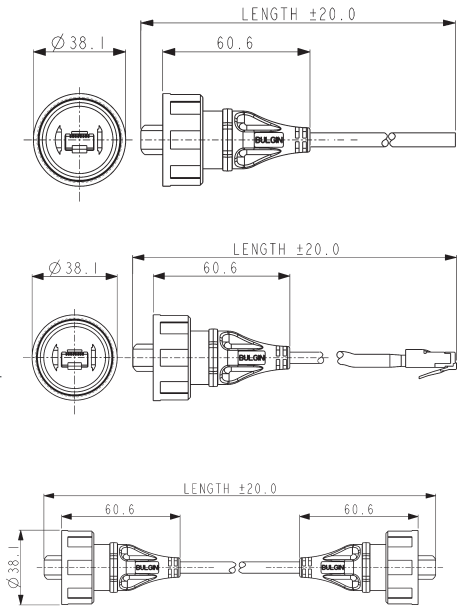

Part no.	Type	Length	Description
PX0836/2M00	Wire end	2m	IP68 RJ45 Buccaneer to bare end
PX0836/3M00	Wire end	3m	IP68 RJ45 Buccaneer to bare end
PX0836/5M00	Wire end	5m	IP68 RJ45 Buccaneer to bare end
PX0837/2M00	Single ended	2m	IP68 RJ45 Buccaneer to Shielded RJ45
PX0837/3M00	Single ended	3m	IP68 RJ45 Buccaneer to Shielded RJ45
PX0837/5M00	Single ended	5m	IP68 RJ45 Buccaneer to Shielded RJ45
PX0838/2M00	Double ended	2m	IP68 RJ45 Buccaneer to IP68 RJ45 Buccaneer
PX0838/3M00	Double ended	3m	IP68 RJ45 Buccaneer to IP68 RJ45 Buccaneer
PX0838/5M00	Double ended	5m	IP68 RJ45 Buccaneer to IP68 RJ45 Buccaneer

Re wireable Flex Connector



PX0834

- Mates with all panel mounting connectors
- Supplied with shielded RJ45 plug
- Two versions:  
for PUR jacket cable (Cat 5e)  
for other cable sizes from 3.5 to 8mm dia.

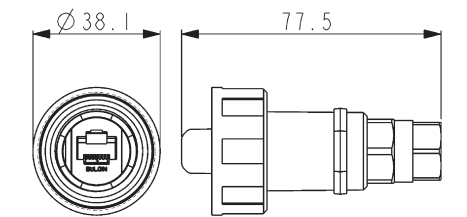

Part no.	Description
PX0834/A	Cable glands optimised for PUR jacket cable to maintain Cat 5e performance
PX0834/B	Suitable for use with cables from 3.5 to 8mm diameter

Panel Mounting Connector



PX0833

- Cat 5e shielded coupler
- Mates with PX0836, PX0837, PX0838 and PX0834 flex connectors
- Standard RJ45 patchcord can be plugged into rear
- Version with earth wire available
- Single hole fixing
- Complete with panel sealing gasket

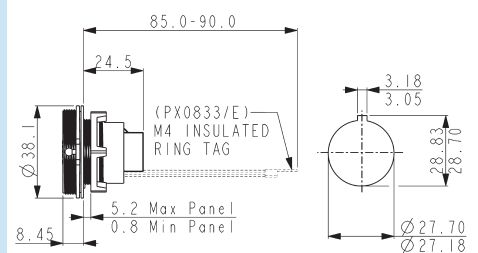

Part no.	Description	Fixing
PX0833	Cat 5e coupler	Front panel mounted
PX0833/E	Cat 5e coupler + earth wire	Front panel mounted



Flanged Mounting Connector



PX0870

- Cat 5e shielded coupler
- Mates with PX0836, PX0837, PX0838 and PX0834 flex connectors
- Standard RJ45 patchcord can be plugged into rear
- Version with earth wire available
- Flange fixing
- Complete with panel sealing gasket & screw sealing washers

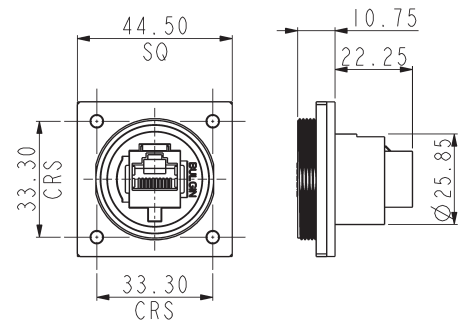

Part no.	Description	Fixing
PX0870	Cat 5e coupler	Flange mounting
PX0870/E	Cat 5e coupler + earth wire	Flange mounting

PCB Mounting Connector



PX0839/PC

- Cat 5e shielded RJ45 interface
- Rear of panel mounted
- Mates with PX0836, PX0837, PX0838 and PX0834 flex connectors
- For direct vertical mounting to PCB, straight pins
- Complete with panel sealing PX0839/PC gasket

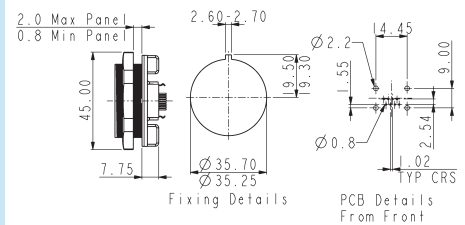

Part no.	Description	Fixing
PX0839/PC	Cat 5e connector - PC	Rear panel mounted

PCB Mounting Connector



PX0839/90

- Cat 5e shielded RJ45 interface
- Rear of panel mounted
- Mates with PX0836, PX0837, PX0838 and PX0834 flex connectors
- For direct horizontal mounting to PCB, 90° pins
- Complete with panel sealing PX0839/90 gasket

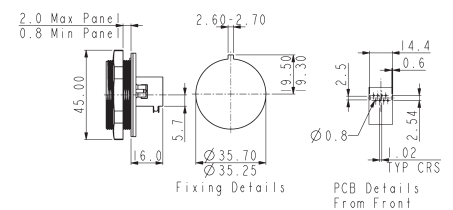

Part no.	Description	Fixing
PX0839/90	Cat 5e connector - PC	Rear panel mounted

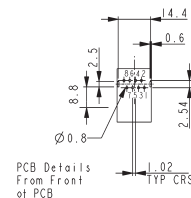

Panel Mounting Connector



PX0839/IDC

- Cat 5e shielded RJ45 interface
- Rear of panel mounted
- Mates with PX0836, PX0837, PX0838 and PX0834 flex connectors
- Two IDC blocks for discrete termination
- Complete with panel sealing

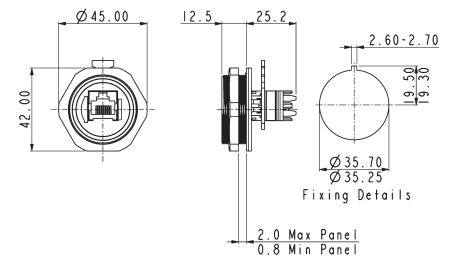

Part no.	Description	Fixing
PX0839/IDC	Cat 5e coupler	Rear panel mounted

Shield Back Shell Accessory



PX0888

- Maintains RJ45 coupler screening directly to panel
- Shielding can is fixed to rear of panel mount connector
- For use on PX0833

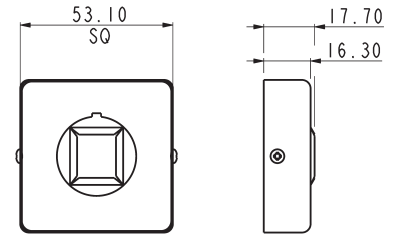

Part no.	Description
PX0888	Shielding backshell accessory

Accessories



Sealing Caps

- Sealing caps to maintain IP68 rating when connectors are not in use
- Replacement shielded RJ45s
- Hand crimp tool for shielded RJ45
- Patch cord cable available in 50m reels

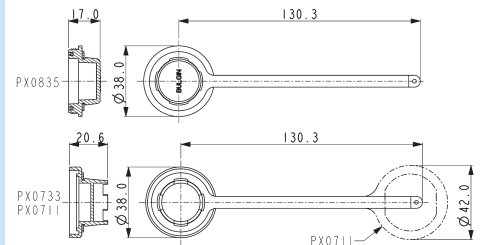

Part no.	Description
PX0835	Sealing Cap for flex connectors (PX0834, PX0836-838)
PX0733	Sealing Cap for panel mounting connector (PX0833, PX0870)
PX0711	Sealing Cap for rear panel mounting connector (PX0839)
14151	Hand crimp tooling + die set
14199	PUR Jacket Cable - 50m reel
14150	Replacement shielded RJ45

## Connectors

Sealing	IP69K, Tested in accordance with DIN 40050/Part 9 IP6k9k
	IP68, EN60529:1992+A2:2013 (10m depth for 2 weeks)
Operating Temperature	-20°C to +70°C
Materials - Overmoulded	
Overmould material	PVC (black)
Flammability rating	UL94V-0
Salt Mist	EN60068-2-52 Test Kb Salt Mist (Cyclic) Marine Severity Level 1

## Materials - Re-wireable and Panel Connectors

Connector body & locking ring	Polyester
Panel connector	Nylon 6
Flammability rating	UL94V-0
'O' rings	Silicone
Panel Gasket - round	Silicone
Panel Gasket - flange	Neoprene
<b>RoHS</b>	Compliant

## Stranded S-FTP Patch cord cable - PUR Jacket

Polyurethane (PUR) jacket cable with internal construction exceeding Cat 5e performance levels. The PUR jacket has excellent abrasion, chemical and ozone resistance, low smoke, low halogen flame retardant construction suitable for internal and external industrial environments.

## Cable

Conductors	24AWG (7/0.2mm) bare copper
Insulation	HD-PE
Pair	2 of the above cores twisted
Core	4 of the above cores
Tape	1 lap mylar tape
Screen	1 layer mylar and aluminium tape, 0.12mm
Sheath	tinned copper braid
Op Temperature	PUR Jacket Black
Min. bend radius	-25°C to +85°C
Min. bend radius	10 x o/d (installation)
Diameter	6 x o/d (installed) 6.1mm nominal

## Electrical @ 20°C

Characteristic Impedance	100 Ω ±15 Ω @ 100MHz
Capacitance	330pF/km
Conductor Loop resistance	29/Ω100m maximum
Skew	45 nsec/100m @ 100MHz
TIA/EIA Rating	Cat 5e

## Cable construction - PX0836, PX0837, PX0838 and 14199

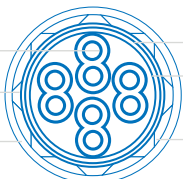
24 AWG 7/0.20mm conductor		Mylar Tape
Braiding 7/0.12mm		Insulation - HD - PE
Jacket 6.10mm dia		Aluminium/ PEPT tape
		Drain Wire

Polyurethane (PUR) Jacket

## RJ45 Plug

### Materials

Moulding	Polycarbonate
Flammability	UL94V-0
Contact material	Phosphor Bronze
Contact plating	50 micron gold
Operating Temperature	-40°C to +70°C
Mating cycles	1,000 cycles
<b>RoHS</b>	Compliant

### Electrical

No. Conductors	8
Conductor types	24-28AWG, solid or multistranded
Current rating	1.5A
Voltage rating	30V ac, 42V dc
Contact resistance	10mΩ max.
Performance	Cat 5e

## RJ45 Coupler

### Materials

Coupler Shell	Copper Alloy
Coupler Plating	Nickel
Moulding	ABS
Flammability	UL94V-0
Contact material	Phosphor Bronze
Contact plating	50 micron gold
Operating Temperature	-40°C to +70°C
Mating cycles	1,000 cycles
<b>RoHS</b>	Compliant

### Electrical

No. Conductors	8
Current rating	1.5A
Voltage rating	30V ac, 42V dc
Contact resistance	10mV max.
Performance	Cat 5e

## RJ45 PCB Connector

### Materials

Coupler Shell	Copper Alloy
Coupler Plating	Nickel
Moulding	ABS
Flammability	UL94V-0
Contact material	Phosphor Bronze
Contact plating	50 micron gold
PC Pins	Tin plated
Operating Temperature	-40°C to +70°C
Mating cycles	1,000 cycles
<b>RoHS</b>	Compliant

### Electrical

No. Conductors	8
Current rating	1.5A
Voltage rating	30V ac, 42V dc
Contact resistance	10mΩ max.
Performance	Cat 5e

Cable Joiner



PX0777

- IP68 Rating
- For Sealed In-Line RJ45 Connections
- Supplied Complete with Coupler
- Shielded (STP) & Unshielded (UTP) versions
- Cat5e Shielded Coupler also available
- Cable Range 3.5 - 8mm (with glands supplied)

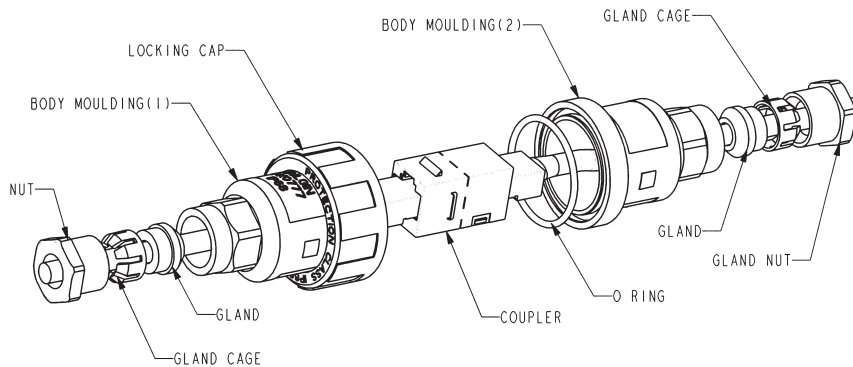
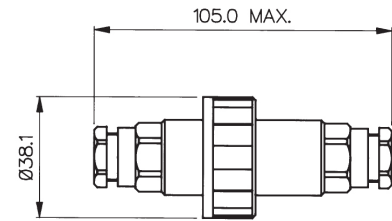

Specifications	PX0777/UTP	PX0777/STP	PX0777/CAT5ESTP
Rating:	1.5A, 30V a.c., 42V d.c.	1.5A, 30V a.c., 42V d.c.	1.5A, 30V a.c., 42V d.c.
No. of Conductors:	8	8	8
Coupler Type:	Unshielded	Shielded	Shielded CAT5e performance
Cable Range:	3.5 - 8mm With glands supplied: 3.5 - 5mm (Blue) 5 - 7mm (Green) 6 - 8mm (Red)	3.5 - 8mm With glands supplied: 3.5 - 5mm (Blue) 5 - 7mm (Green) 6 - 8mm (Red)	3.5 - 8mm With glands supplied: 3.5 - 5mm (Blue) 5 - 7mm (Green) 6 - 8mm (Red)
Material:	Glass Filled Polyamide UL94V-0	Glass Filled Polyamide UL94V0	Glass Filled Polyamide UL94V0
Sealing:	IP68 to BSEN 60529:1992+A2:2013 (10m depth for 2 weeks)	IP68 to BSEN 60529:1992+A2:2013 (10m depth for 2 weeks)	IP68 to BSEN 60529:1992+A2:2013 (10m depth for 2 weeks)
Salt Mist	EN60068-2-52 Test Kb Salt Mist (Cyclic) Marine Severity Level 1	EN60068-2-52 Test Kb Salt Mist (Cyclic) Marine Severity Level 1	EN60068-2-52 Test Kb Salt Mist (Cyclic) Marine Severity Level 1
Operating Temp Range:	-20°C to +70°C	-20°C to +70°C	-20°C to +70°C
Colour:	Black	Black	Black
RoHS	Compliant	Compliant	Compliant



- ⊗ IP68 rated
- ⊗ IP69K, Tested in accordance with DIN 40050/Part 9 IP6k9k
- ⊗ USB version 2.0 performance
- ⊗ Plug and play capability
- ⊗ Visual mating indication
- ⊗ Shielded system
- ⊗ Single and double ended cables
- ⊗ Screw coupling
- ⊗ PCB versions
- ⊗ Dust and waterproof sealing when mated
- ⊗ Low and high speed bus connection, 1.5Mbps to 480Mbps
- ⊗ Hot pluggable, standard 4 pole interface
- ⊗ Alignment indicator reduces risk of damage during mating
- ⊗ High noise immunity and EMI protection
- ⊗ Suitable for PC and peripheral configuration
- ⊗ Secure, proven locking system
- ⊗ Direct mounting or via adaptor leads
- ⊗ EN60068-2-52 Test Kb Salt Mist (Cyclic) Marine Severity Level 1

Sealed USB Cables - Single Ended



PX0840/A



PX0840/B

- Single ended sealed cable assembly**
- IP68 'A' type USB connector to standard 'B' type USB connector, mates with all panel mount connectors
  - IP68 'B' type USB connector to standard 'A' type USB connector, mates with all panel mount connectors
  - Available in 2m, 3m and 5m lengths

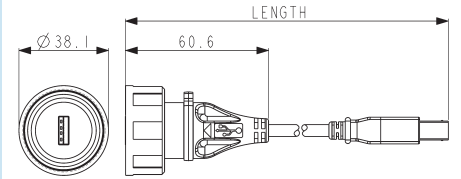

PX0840/A/xMxx

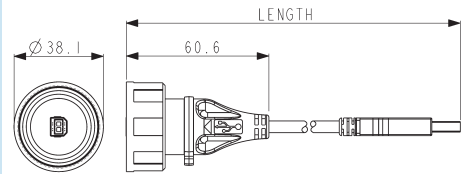

PX0840/B/xMxx

Part no.	Length	Description
PX0840/A/2M00	2m	IP68 A type USB to standard B type USB
PX0840/A/3M00	3m	IP68 A type USB to standard B type USB
PX0840/A/5M00	5m	IP68 A type USB to standard B type USB
PX0840/B/2M00	2m	IP68 B type USB to standard A type USB
PX0840/B/3M00	3m	IP68 B type USB to standard A type USB
PX0840/B/5M00	5m	IP68 B type USB to standard A type USB

Sealed USB Cables Double Ended

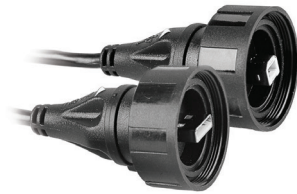

PX0841/AB

- Double ended sealed cable assembly**
- IP68 'A' type USB connector to
  - IP68 'B' type USB connector
  - Mates with all panel mount connectors
  - Available in 2m, 3m and 5m lengths

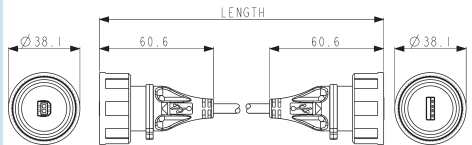

PX0841/AB/xMxx

Part no.	Length	Description
PX0841/AB/2M00	2m	IP68 A type USB to IP68 B type USB
PX0841/AB/3M00	3m	IP68 A type USB to IP68 B type USB
PX0841/AB/5M00	5m	IP68 A type USB to IP68 B type USB

Front Panel Mounting Connector



PX0842/A

PX0842/B

- PX0842/A - USB 'A' type IP68 connector
- PX0842/B - USB 'B' type IP68 connector
- Opposite connector to rear of panel
- Mates with PX0840 and PX0841 cable connectors

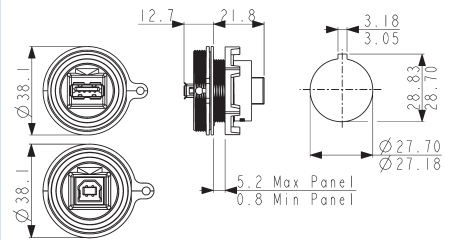

Part no.

Description

PX0842/A  
PX0842/B

IP68 A type USB, front panel mounted. Sealed A type at front of panel, standard B type at rear  
IP68 B type USB, front panel mounted. Sealed B type at front of panel, standard A type at rear.

Front Panel Mounting Connector



PX0843/A

PX0843/B

- PX0843/A - USB 'A' type IP68 connector
- PX0843/B - USB 'B' type IP68 connector
- Leaded with 5 way crimp connector
- Mates with PX0840 and PX0841 cable connectors

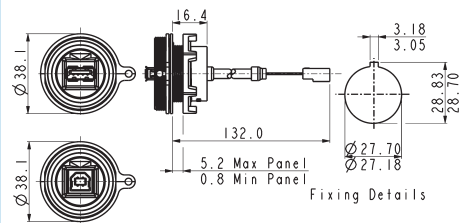

Part no.

Description

PX0843/A  
PX0843/B  
PX0460/A  
PX0460/B

IP68 A type USB, front panel mounted. Sealed A type at front of panel, 5 way crimp connector at rear.  
IP68 B type USB, front panel mounted. Sealed B type at front of panel, 5 way crimp connector at rear.  
As PX0843/A with exposed braid for use with PX0465 screening can  
As PX0843/B with exposed braid for use with PX0465 screening can

Front Panel Mounting Connector



PX0844/A

PX0844/B

- IP68 Sealed through panel
- PX0844/A - USB 'A' type IP68 connector
- PX0844/B - USB 'B' type IP68 connector
- Standard USB interface plug options to rear of panel
- 500mm standard cable length, other lengths available
- Mates with PX0840 and PX0841 cable connectors

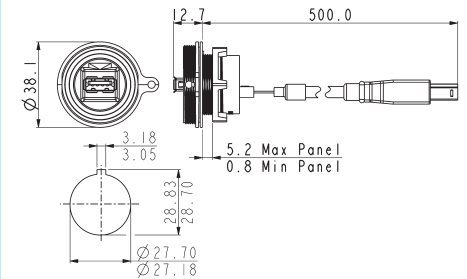

Part no.

Description

PX0844/A/0M50/A  
PX0844/A/0M50/B  
PX0844/B/0M50/A  
PX0844/B/0M50/B

IP68 A type USB, sealed through panel, Sealed 'A' type at front of panel, standard 'A' type at rear  
IP68 A type USB, sealed through panel, Sealed 'A' type at front of panel, standard 'B' type at rear  
IP68 B type USB, sealed through panel, Sealed 'B' type at front of panel, standard 'B' type at rear  
IP68 B type USB, sealed through panel, Sealed 'B' type at front of panel, standard 'B' type at rear

Rear Panel Mounting Connector



PX0848/A

PX0848/B

- PX0848/A - USB 'A' type IP68 connector
- PX0848/B - USB 'B' type IP68 connector
- Opposite connector to rear of panel
- Mates with PX0840 and PX0841 cable connectors

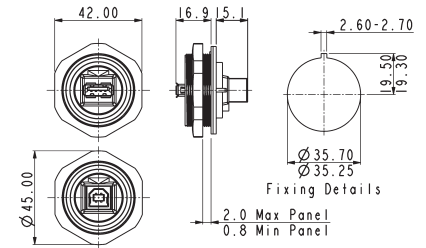

Part no.

Description

PX0848/A  
PX0848/B

IP68 A type USB, rear panel mounted. Sealed A type at front of panel, standard B type at rear.  
IP68 B type USB, rear panel mounted. Sealed B type at front of panel, standard A type at rear.

Rear Panel Mounting Connector



PX0849/A

PX0849/B

- PX0849/A - USB 'A' type IP68 connector
- PX0849/B - USB 'B' type IP68 connector
- Leaded with 5 way header
- Mates with PX0840 and PX0841 cable connectors

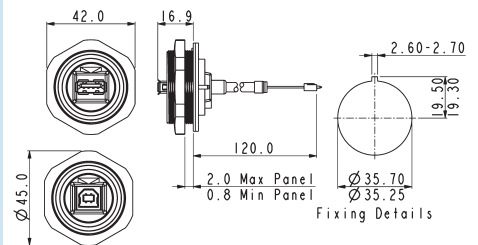

Part no.

Description

PX0849/A  
PX0849/B

IP68 A type USB, rear panel mounted. Sealed A type at front of panel, 5 way header at rear.  
IP68 B type USB, rear panel mounted. Sealed B type at front of panel, 5 way header at rear.

PCB Panel Mounting Connector- PCB Direct Mount



PX0845/A

PX0845/B

- PX0845/A - USB 'A' type IP68 connector
- PX0845/B - USB 'B' type IP68 connector
- PCB contacts at rear
- Direct PCB mount
- Mates with PX0840 and PX0841 cable connectors

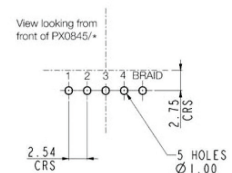
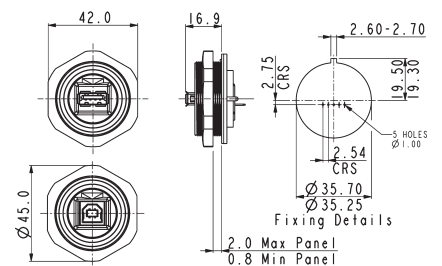

Part no.

Description

PX0845/A  
PX0845/B

IP68 A type USB, rear panel mounted. Sealed A type at front of panel, direct mount PCB contacts at rear.  
IP68 B type USB, rear panel mounted. Sealed B type at front of panel, direct mount PCB contacts at rear.



PCB Adaptor Leads

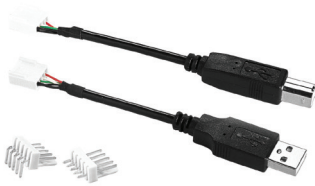

- Standard A and B type USB connectors to 5 way crimp adaptor leads
- 5 way headers, 2.54mm pitch, horizontal or vertical mounting

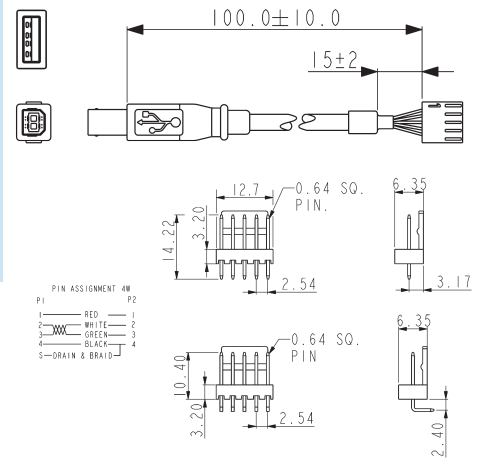

**Part no.**      **Description**

14193	USB 'A' type to 5 way crimp connector
14194	USB 'B' type to 5 way crimp connector
14191	5 way PCB header straight
14192	5 way PCB header right angle

Accessories



- Sealing caps to maintain IP68 rating when connectors are not in use
- PX0835 for cable connectors PX0840 & PX0841
- PX0733 for front panel mount connectors PX0842, PX0843 & PX0844
- PX0711 for rear panel mount connectors PX0848, PX0849 & PX0845

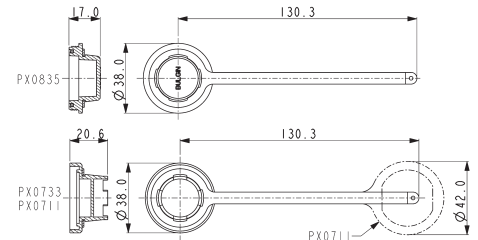

**Part no.**      **Description**

PX0835	Sealing Cap for cable connectors (PX0840, PX0841)
PX0733	Sealing Cap for front panel mounting connector (PX0842, PX0843)
PX0711	Sealing Cap for rear panel mounting connector (PX0848, PX0849, PX0845)

USB Flash Drive Cover



PX0852

- For use with USB Flash Drives
- Maintains IP68 rating when mated with panel connector
- For use with 'A' type connectors: PX0842, PX0843, PX0845, PX0848 & PX0849
- Internal accommodation 17.5 x 14.0 x 83mm approx.

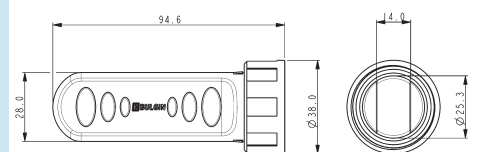

Screening Can

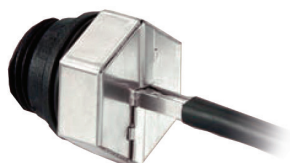

PX0464

- Maintains cable screening directly to panel
- Screening can clips around the panel fixing nut
- For use on PX0460/A and PX0460/B

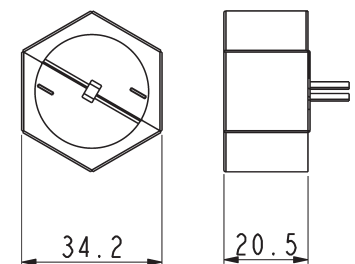

## Cables & connectors

<b>Mechanical</b>	IP69K, Tested in accordance with DIN 40050/Part 9 IP6k9k
	IP68, EN60529:1992+A2:2013 (10m depth for 2 weeks)
Operating temperature	0°C to +70°C
Salt Mist	EN60068-2-52 Test Kb Salt Mist (Cyclic) Marine Severity Level 1
<b>Electrical</b>	
No. of poles	4
Current rating	1A
Voltage rating	30Vac (RMS)
Contact resistance	30m Ω max.
Performance	USB version 2.0

### Materials - Overmoulded

Overmould material	PVC (black)
Flammability rating	UL94V-0

### Materials - Re-wireable and Panel Connectors

Shell material	Steel
Shell plating	Nickel
Contact material	Copper Alloy
Contact plating	30 micro inch Gold
Connector body & locking ring	Glass Loaded Polyester
Panel connector	Nylon 6
Flammability rating	UL94V-0
'O' rings	Silicone
Panel Gasket - round	Silicone
Panel Gasket - square	Neoprene
Mating cycles	1,000
RoHS	Compliant

### Materials - cable

Cable Jacket	PVC (black)
Screen	Tinned copper braid
Flammability	UL94V-0
<b>RoHS</b>	Compliant

Length:	Dia	Conductors Signal	Conductors Power
2m	4.8mm	2 x 28AWG	2 x 24AWG
3m	5.0mm	2 x 28AWG	2 x 22AWG
5m	5.2mm	2 x 25AWG	2 x 20AWG

## PCB adaptor leads

<b>Electrical</b>	
No. of conductors	4
Current rating	1A
Voltage rating	30Vac (RMS)
Contact resistance	<10m Ω max.
PCB pitch	2.54mm
<b>Materials</b>	
Moulding	Polycarbonate
Flammability	UL94V-0
Contact material	Copper Alloy
Contact plating	30 micro inch Gold
Wire insulation	PVC (black)
Flammability	UL94-V0
Conductors	4 x 28AWG
Operating temperature	0°C to +70°C
Mating cycles	1,000
RoHS	Compliant

## Cable construction - PX0840, PX0841

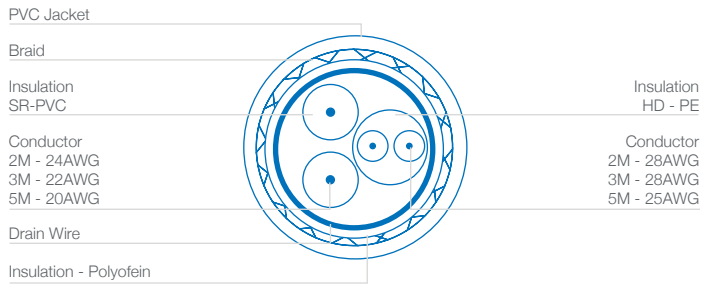

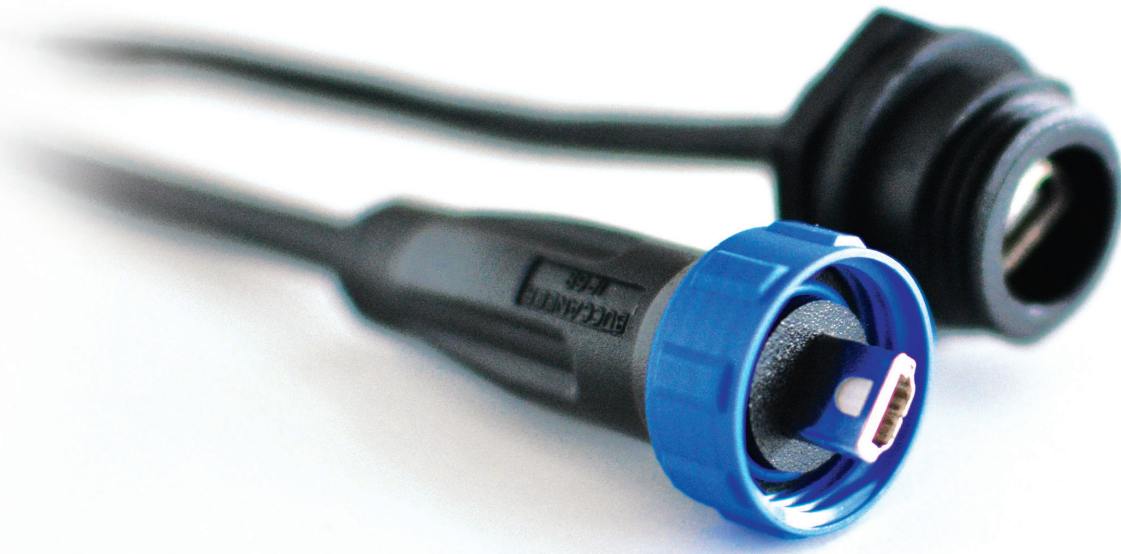

- ⊕ IP68 rated
- ⊕ IP69K, Tested in accordance with DIN 40050/Part 9 IP6k9k
- ⊕ USB V2.0 performance
- ⊕ Plug and play capability
- ⊕ Shielded system
- ⊕ Overmoulded cables
- ⊕ Screw coupling
- ⊕ PCB versions
- ⊕ Dust and waterproof to EN60529
- ⊕ Data rates up to 480Mbps
- ⊕ Hot pluggable, standard 4 pole interface
- ⊕ High noise immunity
- ⊕ Tamperproof construction
- ⊕ Secure, proven locking system
- ⊕ Direct mounting or via adaptor leads
- ⊕ EN60068-2-52 Test Kb Salt Mist (Cyclic) Marine Severity Level 1



PX0441

- Standard 'A' type to sealed Mini 'B' type
- Fully overmoulded construction
- Available in 2, 3 & 4.5m lengths
- Mates with PX0443, PX0446, PX0447, PX0456, PX0457 & PX0458

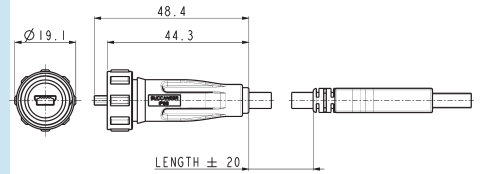

PX0442

- Mini 'A' type to sealed mini 'B' type
- Fully overmoulded construction
- Available in 2, 3 & 4.5m lengths
- Mates with PX0443, PX0446, PX0447, PX0456, PX0457 & PX0458

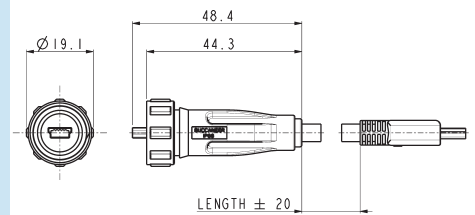

PX0444

- Mini 'B' type to Sealed Mini 'A' type
- Fully overmoulded construction
- Available in 2, 3 & 4.5m lengths
- Mates with PX0456, PX0457 & PX0458

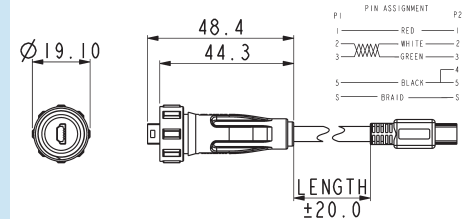

Part No.	Length	Description
PX0441/2M00	2.0m	IP68 mini 'B' to Std 'A' type USB
PX0441/3M00	3.0m	IP68 mini 'B' to Std 'A' type USB
PX0441/4M50	4.5m	IP68 mini 'B' to Std 'A' type USB
PX0442/2M00	2.0m	IP68 mini 'B' to Mini 'A' type USB
PX0442/3M00	3.0m	IP68 mini 'B' to Mini 'A' type USB
PX0442/4M50	4.5m	IP68 mini 'B' to Mini 'A' type USB
PX0444/2M00	2.0m	IP68 mini 'A' to Mini 'B' type USB
PX0444/3M00	3.0m	IP68 mini 'A' to Mini 'B' type USB
PX0444/4M50	4.5m	IP68 mini 'A' to Mini 'B' type USB

Front Panel Mounting Connector



PX0443

- Mini 'B' type
- Leaded with 5 way crimp, for use with PC header
- Mates with PX0441 & PX0442 type cables

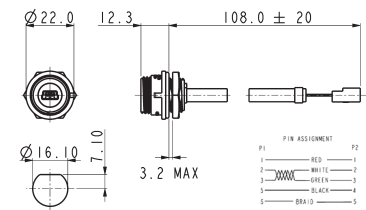

**Part no.**                      **Description**

PX0443	IP68 B type Mini USB, front panel mounted. 5 way crimp connector at rear.
PX0459	As PX0443 with exposed braid for use with PX0464 screening can

Front Panel Mounting Connector



PX0456

- Mini 'AB' type
- Leaded with 6 way crimp, for use with PC header
- Mates with PX0441, PX0442 & PX0444 type cables

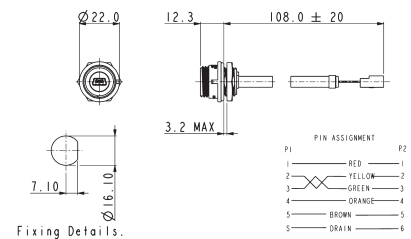

**Part no.**                      **Description**

PX0456	IP68 AB type Mini USB, front panel mounted. 6 way crimp connector at rear.
--------	--

Rear Panel Mounting Connector



PX0446

- Mini 'B' type
- Leaded with 5 way header
- Mates with PX0441 & PX0442 type cables

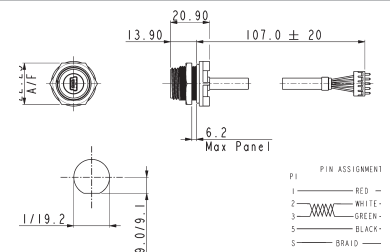

Rear Panel Mounting Connector



PX0447

- Mini 'B' type
- With pins for direct PC mounting
- Mates with PX0441 & PX0442 type cables

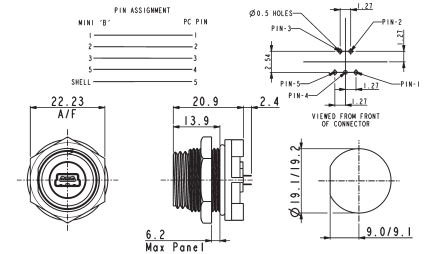

**Part no.**                      **Description**

PX0446	IP68 B type Mini USB, rear panel mounted. 5 way header connector at rear.
PX0447	IP68 B type Mini USB, rear panel mounted. PC terminals at rear.

Rear Panel Mounting Connector



PX0457

- Mini 'AB' type
- Leaded with 6 way header
- Mates with PX0441, PX0442 & PX0444 type cables

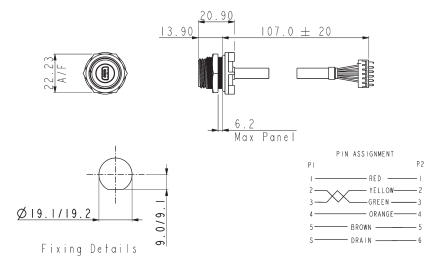

Rear Panel Mounting Connector



PX0458

- Mini 'AB' type
- With pins for direct PC mounting
- Mates with PX0441, PX0442 & PX0444 type cables

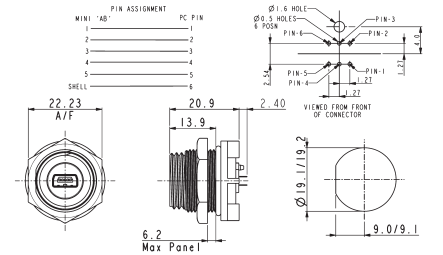

Part no.	Description
PX0457	IP68 AB type Mini USB, rear panel mounted. 6 way header connector at rear.
PX0458	IP68 AB type Mini USB, rear panel mounted. PC terminals at rear.

Screening Can

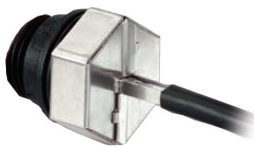

PX0464

- Maintains cable screening directly to panel
- Shielding can clips around the panel fixing nut
- For use on PX0459

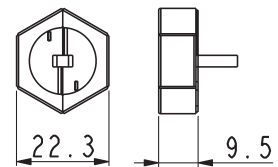

Accessories



- Sealing caps to maintain IP rating when connectors are not in use
- PCB headers for use with PX0443 & PX0456

Part no.	Description
PX0485	Sealing cap for use with PX0441, PX0442 & PX0444
PX0480	Sealing cap for use with PX0443 & PX0456
PX0484	Sealing cap for use with PX0446, PX0447, PX0457 & PX0458
14191	5 way straight header
14192	5 way right angle header
14563	6 way straight header
14564	6 way right angle header

**Cables & connectors**

**Mechanical**

Sealing	IP68, EN60529:1992+A2:2013 (10m depth for 2 weeks) IP69K, Tested in accordance with DIN 40050/Part 9 IP6k9K
Operating temperature	0°C to +70°C
Salt Mist	EN60068-2-52 Test Kb Salt Mist (Cyclic) Marine Severity Level 1

**Electrical**

No. of poles	4 and 5
Current rating	1A
Voltage rating	30Vac, 42Vdc
Contact resistance	50m Ω max.
Performance	USB version 2.0

**Materials - Overmoulded**

Overmould material	PVC (black)
Flammability rating	UL94V-0

**Materials - Re-wireable and Panel Connectors**

Shell material	Steel
Shell plating	Nickel
Contact material	Copper Alloy
Contact plating	50 micro inch Gold
Connector body & locking ring	Polyester
Panel connector	Nylon 6
Flammability rating	UL94V-0
'O' rings	Nitrile
Mating cycles	5,000
<b>RoHS</b>	Compliant

**Materials - cable**

Cable Jacket	PVC (black)
Screen	Tinned copper braid
Flammability	UL94V-0
<b>RoHS</b>	Compliant

Length:	Dia	Conductors Signal	Conductors Power
2m	4.8mm	2 x 28AWG	2 x 24AWG
3m	5.0mm	2 x 28AWG	2 x 22AWG
5m	5.2mm	2 x 25AWG	2 x 20AWG

**Cable construction - PX0441, PX0442, PX0444**

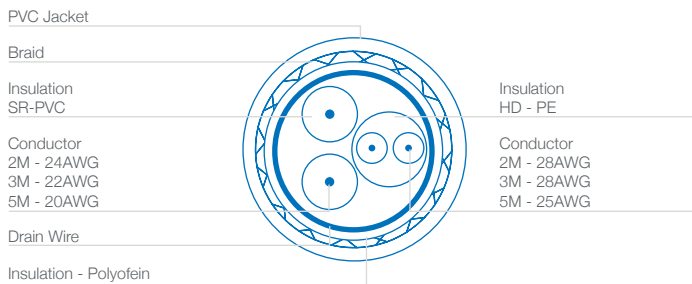



- Sealed to IP68 when mated
- IP69K, Tested in accordance with DIN 40050/Part 9 IP6k9k
- 50Ω Impedance SMB connector
- Frequency range 0-4GHz
- Contact resistance
  - centre - 6mΩ max.
  - outer - 2.5mΩ max.
- Gold plated contacts
- Diameter over coupling ring 19mm
- Body moulding, Nylon UL94-V0 rated
- Two versions of Flex Connector
  - re-wireable
  - pre-wired - lengths 1m, 3m & 5m
- Panel connector
  - pre-wired - lengths 0.5m, 1m & 1.5m
- Cable accommodation (flex re-wireable), RG-174
- Cable type (pre-wired connectors), RG-174



Re- Wireable Flex Connector



PX0415/1

- Mates with Panel connector (PX0414)
- Re-wireable connector
- For RG-174 cable
- Supplied with SMB plug

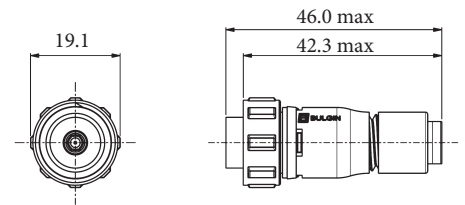

Part no.	Description
PX0415/1	Re-wireable connector with SMB Plug - for RG-174 cable

Pre- Wireable Flex Connector

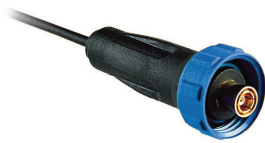

PX0416/xMxx

- Mates with Panel connector (PX0414)
- Pre-wired
- Overmoulded construction
- Supplied with SMB plug terminated with RG-174 cable
- 1m, 3m & 5m cable lengths

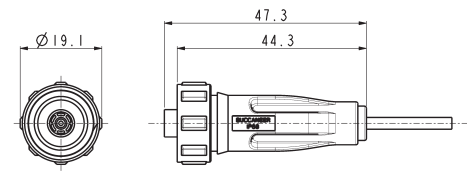

Part no.	Description
PX0416/1M00	Overmoulded connector with SMB plug - cable length 1m
PX0416/3M00	Overmoulded connector with SMB plug - cable length 3m
PX0416/5M00	Overmoulded connector with SMB plug - cable length 5m

Panel Mounting Connector



PX0414/xMxx

- Mates with Flex connectors (PX0415, PX0416)
- Single hole fixing
- Supplied with SMB jack terminated with RG-174 cable
- U.FL cable version also available

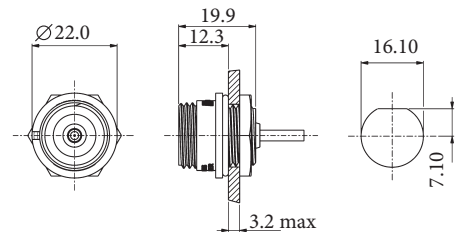

Part no.	Description
PX0414/0M50	Panel connector with SMB jack - cable length 0.5m
PX0414/1M00	Panel connector with SMB jack - cable length 1m
PX0414/1M50	Panel connector with SMB jack - cable length 1.5m

Sealing Cap and Accessories



PX0480 PX0481 PX0485

- Sealing caps maintain IP rating when connectors are not in use

Part no.	Description
PX0480	Sealing cap for PX0414 chassis connector
PX0481	Sealing cap for PX0415 re-wireable flex connectors
PX0485	Sealing cap for PX0416 overmoulded flex connector
14319	Hand crimp tool for SMB

**Electrical**

Impedance:	50Ω
Frequency Range:	0-4GHz
Contact Resistance:	
Centre:	6mΩ (max.)
Outer:	2.5mΩ (max.)
Insulator Resistance:	1000MΩ (max.)

**Mechanical:**

Sealing:	IP69K, Tested in accordance with DIN 40050/Part 9 IP6k9k
	IP68, EN60529:1992+A2:2013 (10m depth for 2 weeks)
Salt Mist	EN60068-2-52 Test Kb Salt Mist (Cyclic) Marine Severity Level 1
Cable Acceptance:	RG-174
Insertion/Withdrawal Force:	
Insertion Force:	36N
Withdrawal Force:	36N
Cable Retention Force:	18N
Mating Cycles:	500
Operating Temperature:	-20°C to +80°C

**Material:**

PX0415/1 and PX0414	
Body Mouldings:	Polyamide
Flammability Rating:	UL94V-0
UV Resistance:	To EN 50021:1999
PX0416	
Body Mouldings:	PVC (black)
Flammability Rating:	UL94V-0
O Rings:	Nitrile
Panel Sealing O Ring:	Nitrile
SMB Connector	
Body:	Brass to QQ-B-626, Gold Plated
Centre Contact:	
Plug:	Brass to QQ-B-626, Gold Plated
Jack:	Beryllium Copper to QQ-B-530, Gold Plated
Insulator:	Teflon
Crimp Ferrules:	Annealed Copper
<b>RoHS</b>	Compliant

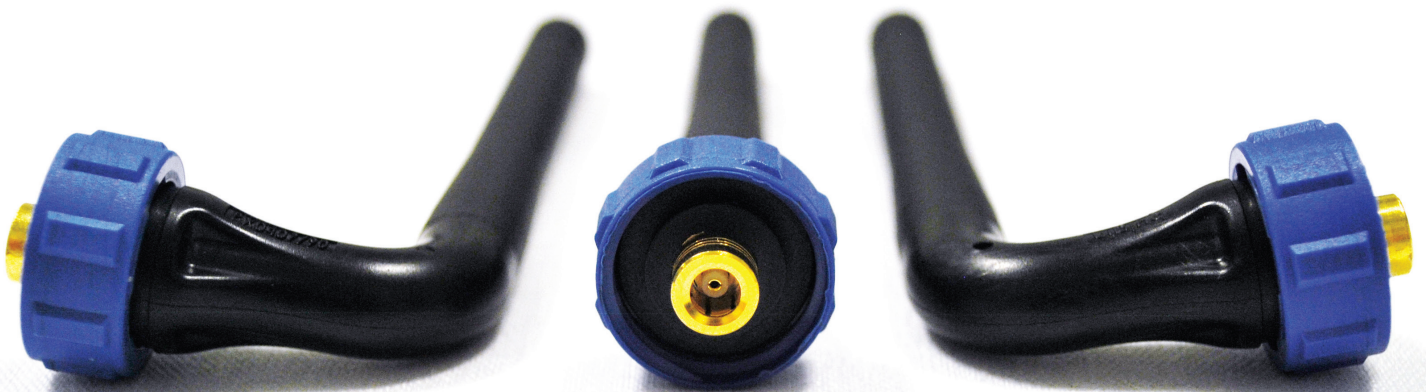

#### SMB Antenna

- ⊕ IP68 Sealing
- ⊕ IP69K, Tested in accordance with DIN 40050/Part 9 IP6k9k
- ⊕ SMB 50 ohm interface
- ⊕ For use with SMB Buccaneer
- ⊕ Three frequency bands:  
440 to 470MHz  
900/1800/1900MHz  
2.4 to 2.5GHz
- ⊕ Maintains sealing integrity of equipment

#### Bluetooth Cable Replacement

- ⊕ IP68 Sealing
- ⊕ RS485/RS232 serial interfaces
- ⊕ Serial data to Bluetooth
- ⊕ Wireless transparent data connection
- ⊕ Up to 100m range (class 1)
- ⊕ Maintains sealing integrity of equipment

BUCCANEER FOR DATA  
**400 Series - Wireless Buccaneer**

Antenna



SMB Antenna



- Dust & waterproof to IP68  
EN60529 when mated
- Secure screw thread locking
- Built-in sealed antenna
- Mates with SMB Buccaneer  
PX0414
- Frequency bands:  
2.4 to 2.5GHz  
440 to 470MHz  
900/1800/1900MHz

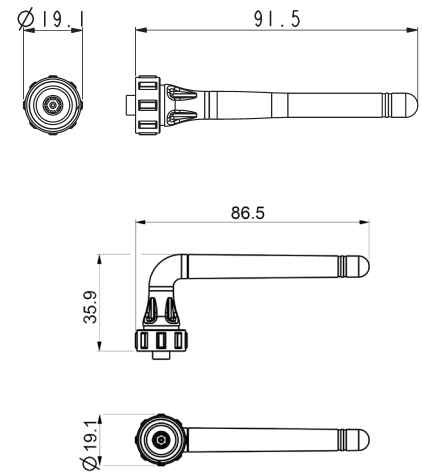

Part no.	Description
PX0407	IP68 rated, Buccaneer Antenna, 2.4 to 2.5GHz frequency band
PX0408	IP68 rated, Buccaneer Antenna, 440 to 470MHz frequency band
PX0409	IP68 rated, Buccaneer Antenna, 900/1800/1900MHz frequency band
PX0407/90	IP68 rated, Buccaneer Antenna, 2.4 to 2.5GHz frequency band
PX0408/90	IP68 rated, Buccaneer Antenna, 440 to 470MHz frequency band
PX0409/90	IP68 rated, Buccaneer Antenna, 900/1800/1900MHz frequency band

**Specification**

**Electrical**

Frequency	
PX0407	2.4 to 2.5GHz
PX0408	440 to 470MHz
PX0409	850-900/1800/1900MHz

Configuration	
PX0407	¼ Wavelength
PX0408	½ Wavelength
PX0409	½ Wavelength

Radiation	Omnidirectional
Polarization	Vertical
Impedance	50Ω nominal
VSWR	<2

**Mechanical**

Sealing	IP69K, Tested in accordance with DIN 40050/Part 9 IP6k9k IP68, EN60529:1992+A2:2013, when mated (10m depth for 2 weeks)
---------	--

Operating Temperature:	-20°C to +65°C
Salt Mist	EN60068-2-52 Test Kb Salt Mist (Cyclic) Marine Severity Level 1

**Material**

Body Mouldings	PVC
Flammability Rating	UL94V-0
UV Resistance	EN50021:1999
RoHS	Compliant

## PX0407 Polar plots

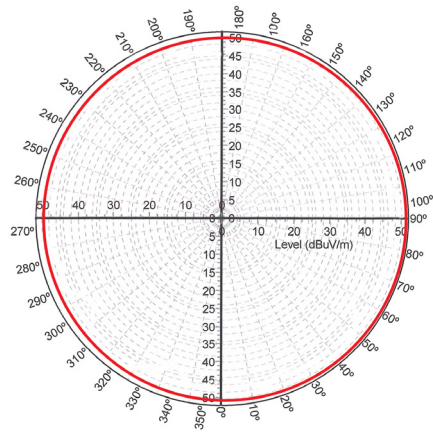
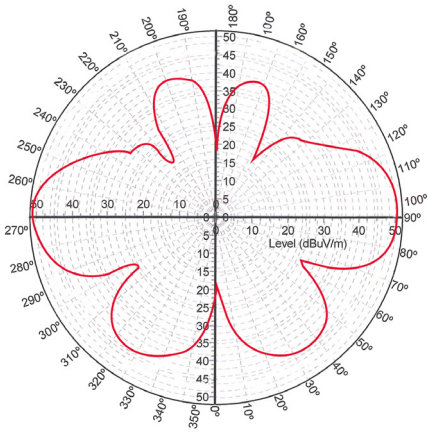

## PX0407 Radiation Pattern plots

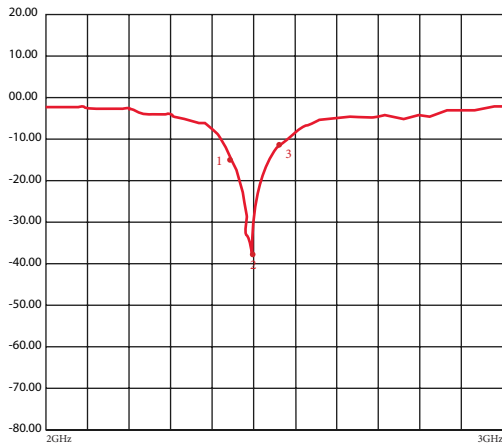

- 1 -12624 dB 2.v0 GHz
- 2 -34951 dB 2.45000 GHz
- 3 -12.777 dB 2500.000 000 MHz

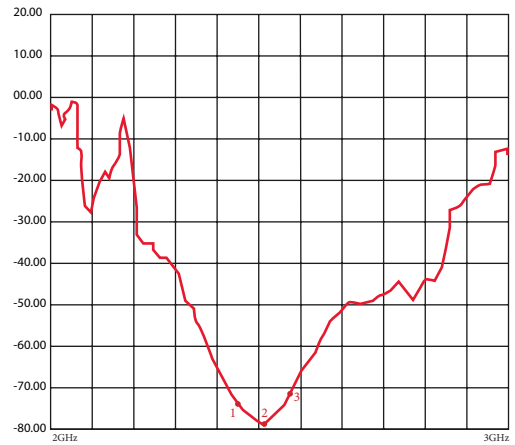

- 1 1.5659 dB 2.40000 GHz
- 2 1.6514 dB 2.45000 GHz
- 3 1.6032 dB 2500.000 000 MHz

# 400 Series - Wireless Buccaneer

Polar/Antenna Plots



## PX0408 Polar plots

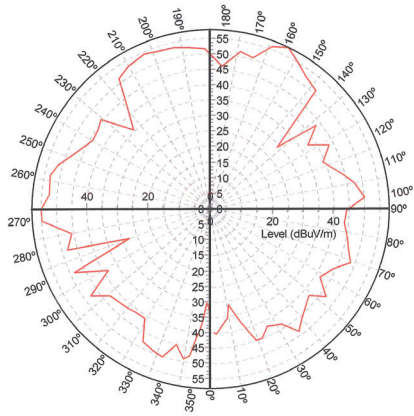

Pattern Field

E

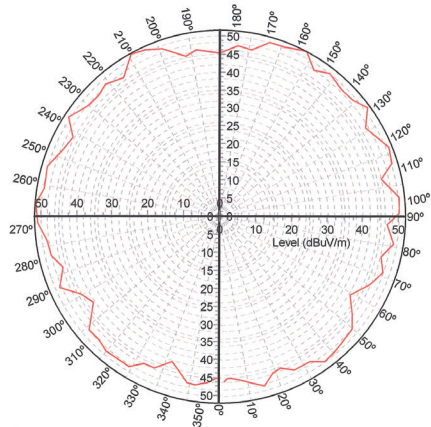

Pattern Field

H

## PX0408 Radiation Pattern plots

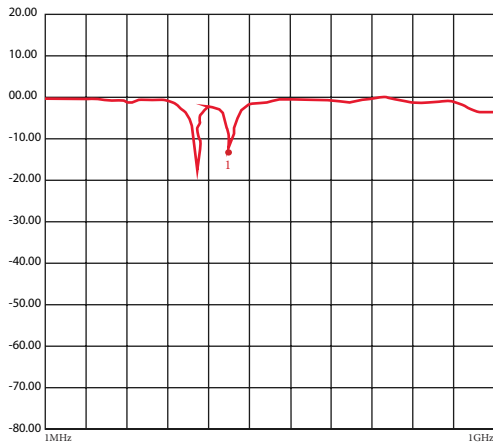

1 450.00000 MHz -13.300 dB

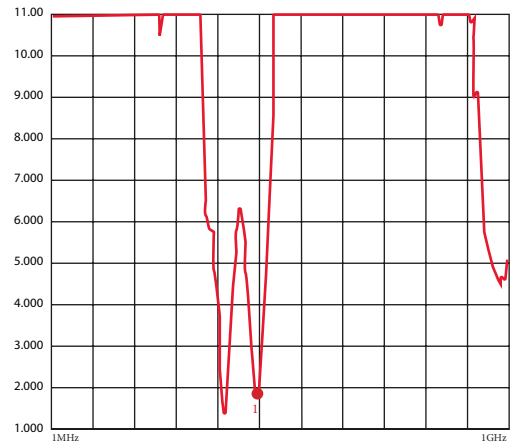

1 450.00000 MHz -13.300 dB

# 400 Series - Wireless Buccaneer

Polar/Antenna Plots



## PX0409 / 900MHz Polar plots

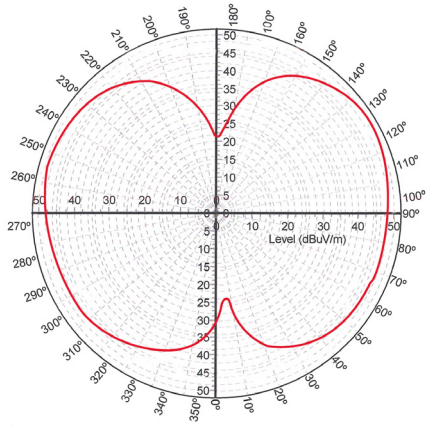

Pattern Field E

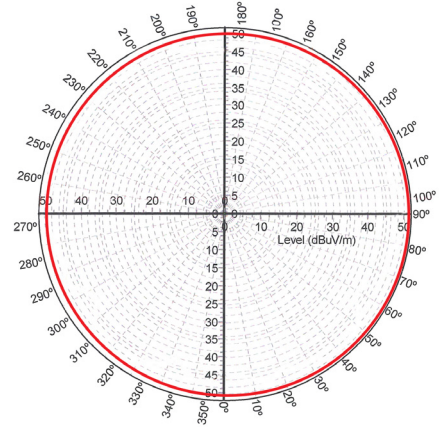

Pattern Field H

## PX0409 / 900MHz Radiation Pattern plots

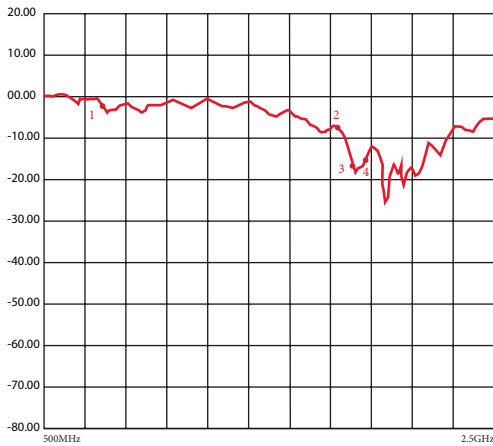

- 1 900.00000 MHz -3.4307 dB
- 2 1.8000000 GHz -9.0130 dB
- 3 1.8800000 GHz -19.516 dB
- 4 1.9000000 GHz -20.297 dB

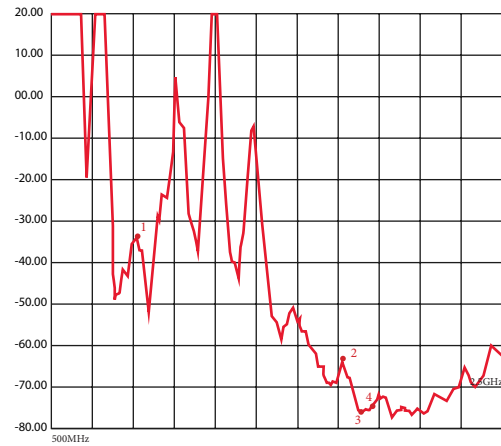

- 1 900.00000 MHz 5.1694 dB
- 2 1.8000000 GHz 2.2481 dB
- 3 1.8800000 GHz 1.2377 dB
- 4 1.9000000 GHz 1.2052 dB

# 400 Series - Wireless Buccaneer

Polar/Antenna Plots



## PX0409 / 1800MHz Polar plots

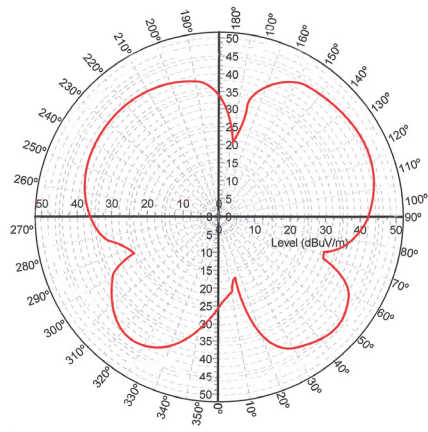

Pattern Field

E

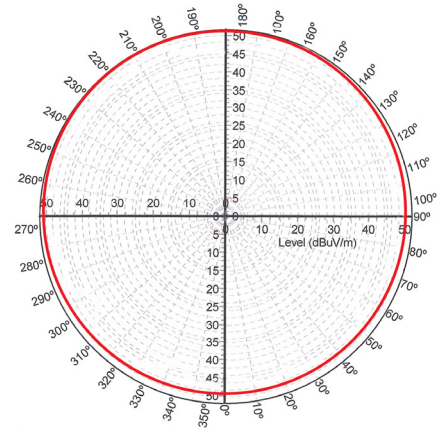

Pattern Field

H

## PX0409 / 1800MHz Radiation Pattern plots

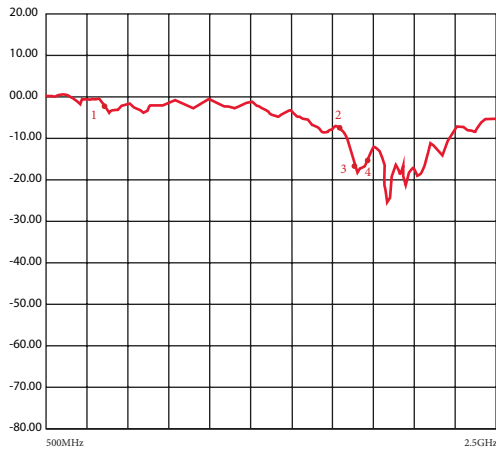

- 1 1.9000000 MHz -3.4307 dB
- 2 1.8000000 GHz -9.0130 dB
- 3 1.8800000 GHz -19.516 dB
- 4 1.9000000 GHz -20.297 dB

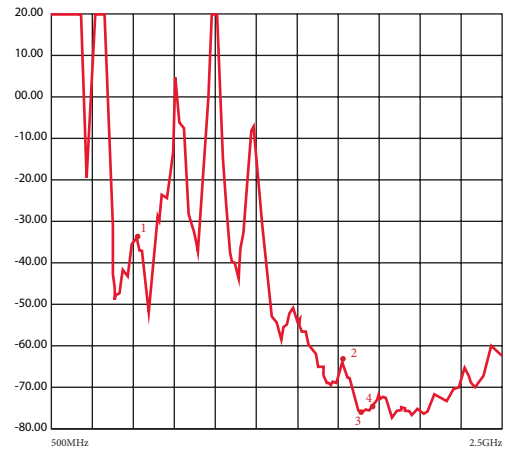

- 1 1.9000000 MHz 5.1694 dB
- 2 1.8000000 GHz 2.2481 dB
- 3 1.8800000 GHz 1.2377 dB
- 4 1.9000000 GHz 1.2052 dB



# 400 Series - Wireless Buccaneer

Polar/Antenna Plots



## PX0409 / 1900MHz Polar plots

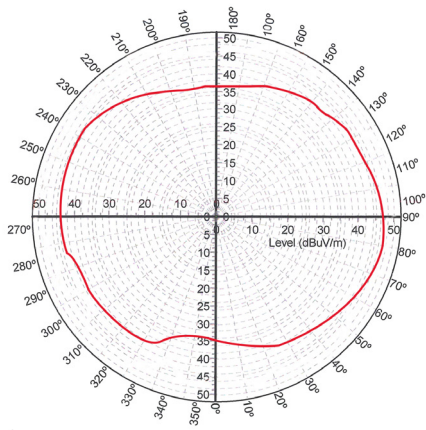

Pattern Field

E

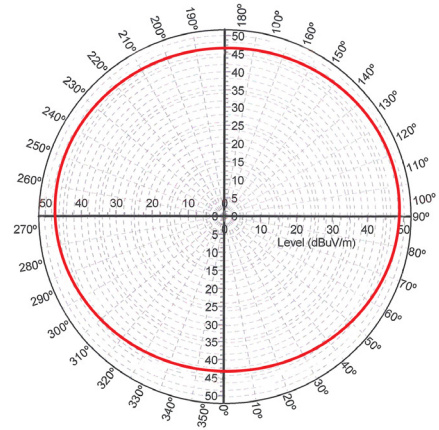

Pattern Field

H

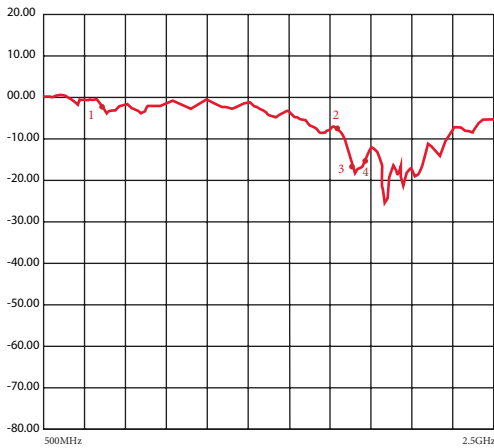

- 1 900.00000 MHz -3.4307 dB
- 2 1.8000000 GHz -9.0130 dB
- 3 1.8800000 GHz -19.516 dB
- 4 1.9000000 GHz -20.297 dB

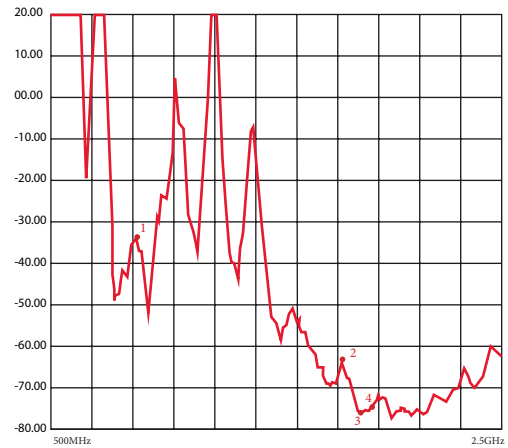

- 1 900.00000 MHz 5.1694 dB
- 2 1.8000000 GHz 2.2481 dB
- 3 1.8800000 GHz 1.2377 dB
- 4 1.9000000 GHz 1.2052 dB



- ⊞ IP66, IP68 and IP69K rated
- ⊞ USB V2.0 performance
- ⊞ Plug and play capability
- ⊞ Shielded system
- ⊞ Overmoulded cables
- ⊞ EN60068-2-52 Test Kb Salt Mist (Cyclic) Marine Severity Level 1
- ⊞ Data rates up to 480Mbs
- ⊞ Secure, proven locking system
- ⊞ Tamperproof Construction
- ⊞ Colour coded O-rings & washers for easy identification purposes



PXP4040

- Standard 'A' type to sealed Micro 'B' type
- Available in 2, 3 & 5m lengths
- Plug variant mates with PXP4043

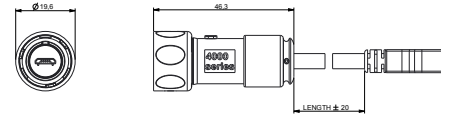

Part No.	Length	Description
PXP4040/B/2M00	2.0m	IP-sealed micro 'B' to Std 'A' type USB
PXP4040/B/3M00	3.0m	IP-sealed micro 'B' to Std 'A' type USB
PXP4040/B/5M00	5.0m	IP-sealed micro 'B' to Std 'A' type USB

### Rear Panel Mounting Connector



PXP4043

- Micro 'B' type
- Leaded with 5 way header
- Socket variant mates with PXP4040 type cables

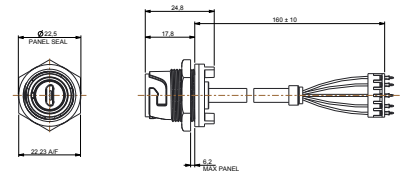

Part no.	Description
PXP4043	IP-sealed B type Micro USB, rear panel mounted. 5 way header connector at rear.

### Accessories



- Sealing caps to maintain IP rating when connectors are not in use

Part no.	Description
PXP4081	Sealing cap for use with PXP4010 & PXP4040
PXP4082	Sealing cap for use with PXP4011
PXP4083	Sealing cap for use with PXP4013 & PXP4043

### Gland Packs



Part no.	Description
PXP4088/0305	Pack of 4 pairs cable glands and collets to suit cables from 3.0 to 5.0mm diameter.
PXP4088/0507	Pack of 4 pairs cable glands and collets to suit cables from 5.0 to 7.0mm diameter.

### O-ring & washer pack



Part no.	Description
PXP4089/WH	White coloured O-ring and washer pack
PXP4089/RD	Red coloured O-ring and washer pack
PXP4089/BL	Blue coloured O-ring and washer pack
PXP4089/YL	Yellow coloured O-ring and washer pack
PXP4089/GN	Green coloured O-ring and washer pack

**Cables & connectors**

**Mechanical**

Sealing	IP69K, DIN40050-9 IP68, EN60529:1992+A2:2013 (10m depth for 2 weeks) IP66, EN60529:1992+A2:2013
Panel Mount Nut	1.0 - 1.1NM (91lb.in)
Operating temperature	-40°C to +70°C
Salt Mist	EN60068-2-52 Test Kb Salt Mist (Cyclic) Marine Severity Level 1

**Electrical**

No. of poles	4 and 5
Current rating	1A
Voltage rating	30Vac, 42Vdc
Contact resistance	50m Ω max.
Performance	USB version 2.0

**Materials - Re-wireable and Panel Connectors**

Shell material	Steel
Shell plating	Nickel
Contact material	Copper Alloy
Contact plating	50 micro inch Gold
Connector body & locking ring	PC/PBT
Panel connector	PC/PBT
Flammability rating	UL94V-0
'O' rings	Silicone
Mating cycles	1,000
<b>RoHS</b>	Compliant

**Materials - cable**

Cable Jacket	PVC (black)
Screen	Tinned copper braid
Flammability	UL94V-0
<b>RoHS</b>	Compliant

Length:	Dia	Conductors	Conductors
		Signal	Power
2m	4.8mm	2 x 28AWG	2 x 24AWG
3m	5.0mm	2 x 28AWG	2 x 22AWG
5m	5.2mm	2 x 25AWG	2 x 20AWG

**Cable construction - PXP4040 & PXP4043**

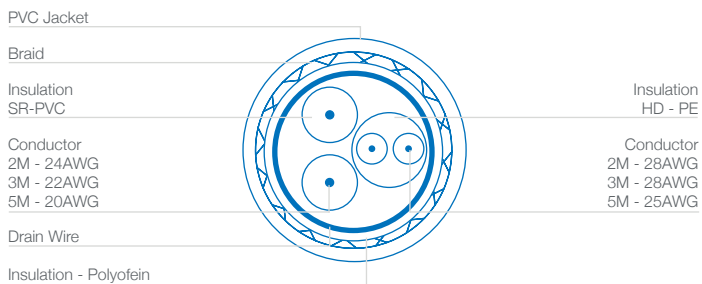

6000 Series Buccaneer – **circular connectors** that combine the ease of use of a **push/pull coupling mechanism** with proven environmental sealing. Available with **metal** or **plastic** bodies, the range supports both data (USB and Ethernet), signal and mains power. Designed and independently tested to **IP66, IP68 & IP69K** standards, they are ideal for applications where ingress of dust and water must be avoided and where ease of connection, space and appearance are important considerations.

- **30° twist locking**  
Tamperproof lock prevents accidental un-mating
- **IP66, IP68 and IP69K when mated**  
Suitable for a wide range of dust and water borne environments
- **Independent sealing tests**  
IP Ratings independently verified
- **USB version 2.0 performance**  
Low and high speed bus connection, 1.5Mbps to 480Mbps
- **Plug and play capability**  
Hot pluggable, standard 4 pole interface
- **Shielded system**  
High noise immunity and EMI protection
- **Single and double ended cables**  
Suitable for PC and peripheral configuration
- **Push-pull latching system\***  
Secure, instant latching. Quick connector mating and release
- **Cat 5e compliant**  
Data rate up to 100MHz
- **PUR jacket on cable**  
Good chemical resistance, flame retardant
- **Cat 5e shielded coupler**  
Maintains shielding
- **Visual mating indication**  
Alignment indicator reduces risk of damage during mating
- **Earth lead version of panel adaptor on plastic connector**  
Continuous screening of panel mount connector
- **Metal connector grounded to cable screen**  
Continuous screening of panel mount connector
- **Sealed through panel Ethernet**  
Prevent water ingress into equipment
- **EN60068-2-52 Test Kb Salt Mist (Cyclic)**  
Marine Severity Level 1



BUCCANEER FOR DATA  
**6000 Series Buccaneer**

USB Thermo Plastic



Sealed USB Cables - Single Ended



PXP6040/A



PXP6040/B

- Single ended sealed cable assembly
- Mates with all panel mounting connectors
- 30° twist locking
- IP rated 'A' type USB connector to standard 'B' type USB connector, mates with all panel mount connectors
- IP rated 'B' type USB connector to standard 'A' type USB connector, mates with all panel mount connectors
- Available in 2m, 3m and 5m lengths

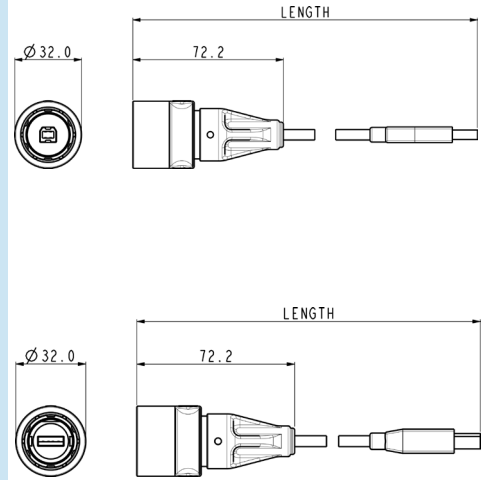

Part no	Length	Description
PXP6040/A/2M00	2m	IP rated A type USB to standard B type USB
PXP6040/A/3M00	3m	IP rated A type USB to standard B type USB
PXP6040/A/5M00	5m	IP rated A type USB to standard B type USB
PXP6040/B/2M00	2m	IP rated B type USB to standard A type USB
PXP6040/B/3M00	3m	IP rated B type USB to standard A type USB
PXP6040/B/5M00	5m	IP rated B type USB to standard A type USB

Sealed USB Cables - Double Ended



PXP6041/AB

- Double ended sealed cable assembly
- Mates with all panel mount connectors
- 30° twist locking
- IP rated 'A' type USB connector to 'B' type USB connector
- Available in 2m, 3m and 5m lengths

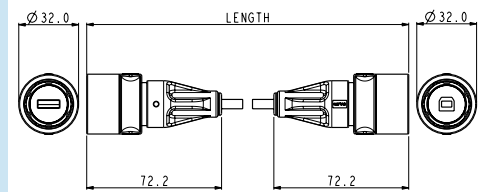

Part no	Length	Description
PXP6041/AB/2M00	2m	IP rated A type USB to standard B type USB
PXP6041/AB/3M00	3m	IP rated A type USB to standard B type USB
PXP6041/AB/5M00	5m	IP rated A type USB to standard B type USB

BUCCANEER FOR DATA  
**6000 Series Buccaneer**

USB Thermo Plastic



Front Panel Mounting Connector



PXP6042/B PXP6042/A

- PXP6042/A - USB 'A' type IP rated connector
- PXP6042/B - USB 'B' type IP rated connector
- Opposite USB type connector to rear of panel
- Mates with PXP6040 and PXP6041 cable connectors

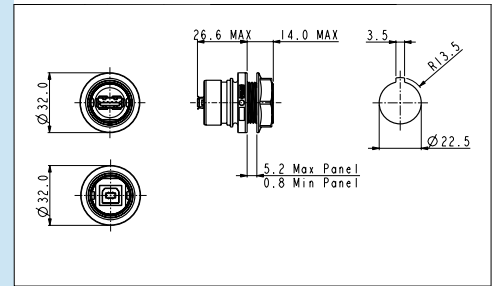

**Part No.**      **Description**

PXP6042/A	IP rated A type USB, front panel mounted. Sealed A type at front of panel, standard B type at rear.
PXP6042/B	IP rated B type USB, front panel mounted. Sealed B type at front of panel, standard A type at rear.

Front Panel Mounting Connector



PXP6043/B PXP6043/A

- PXP6043/A - USB 'A' type IP rated connector
- PXP6043/B - USB 'B' type IP rated connector
- Leaded with 5 way crimp connector
- Mates with PXP6040 and PXP6041 cable connectors

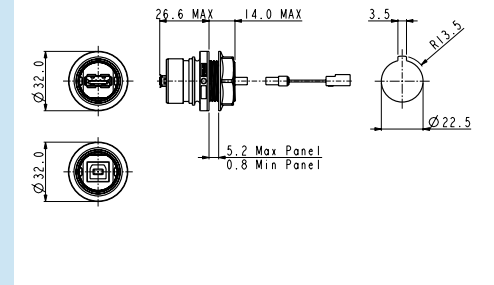

**Part No.**      **Description**

PXP6043/A	IP rated A type USB, front panel mounted. Sealed A type at front of panel, 5 way crimp connector at rear.
PXP6043/B	IP rated B type USB, front panel mounted. Sealed B type at front of panel, 5 way crimp connector at rear.

PCB Adaptor Leads

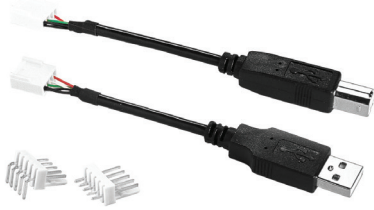

- Standard A and B type USB connectors to 5 way crimp adaptor leads
- 5 way headers, 2.54mm pitch, horizontal or vertical mounting

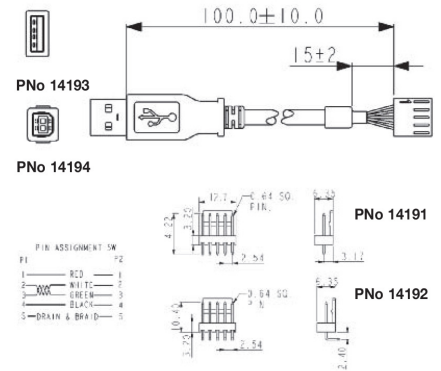

Part No.	Description
14193	USB 'A' type to 5 way crimp connector
14194	USB 'B' type to 5 way crimp connector
14191	5 way PCB header straight
14192	5 way PCB header right angle

Sealing Caps



- Sealing caps to maintain IP rating when connectors are not in use
- PXP6081 for cable connectors PXP6040 & PXP6041
- PXP6083 for front panel mount connectors PXP6042 & PXP6043, with 30° twist lock

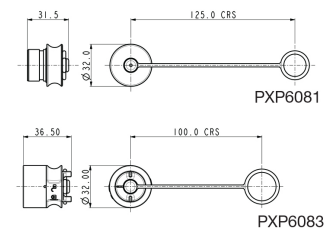

Part No.	Description
PXP6081	Sealing Cap for Flex cable connectors (PXP6040, PXP6041)
PXP6083	Sealing Cap for front panel mounting connector (PXP6042, PXP6043)



BUCCANEER FOR DATA  
**6000 Series Buccaneer**

USB Thermo Plastic - Part No System



<b>PXP</b>	<b>6XXX</b>	<b>X</b>	<b>XXXX</b>
<b>Series Designation</b>	<b>Series / Body Style</b> 040 = Single ended cable 041 = Double ended cable 042 = Panel with adaptor 043 = Panel with lead	<b>Characteristics</b> A = 'A' type sealed interface B = 'B' type sealed interface AB = 'A' & 'B' type sealed interface (for use with 6041 only)	<b>Cable length</b> 2M00 = 2 metre cable length (for use with 6040 and 6041 cables only) 3M00 = 3 metre cable length (for use with 6040 and 6041 cables only) 5M00 = 5 metre cable length (for use with 6040 and 6041 cables only) Blank for 6042 & 6043 panel bodies

**Examples**

PXP6040/A/2M00 = Cable assembly with sealed 'A' type connector to unsealed 'B' type connector, 2 metres long

PXP6042/A = Panel mounted adapter with sealed 'A' type to unsealed 'B' type at rear

**Cables & connectors**

**Mechanical**

Sealing	IP69K, DIN40050-9 IP68, EN60529:1992+A2:2013 (10m depth for 2 weeks) IP66, EN60529:1992+A2:2013
Salt Mist	EN60068-2-52 Test Kb Salt Mist (Cyclic) Marine Severity Level 1
Operating temperature	0°C to +70°C

**Electrical**

No. of poles	4
Current rating	1A
Voltage rating	30Vac (RMS)
Contact resistance	30mΩ max.
Performance	USB version 2.0

**Materials - Overmoulded**

Overmould material	PVC (black)
Flammability rating	UL94V-0

**Materials - Re-wireable and Panel Connectors**

Plastic	PC/PBT
Metal	Machined Brass, Nickel Plated
Flammability rating	UL94V-0
'O' rings	Silicone
Panel Gasket - round	Silicone
Panel Gasket - flange	Silicone

**Materials - cable**

Cable Jacket	PVC (black)
Screen	Tinned copper braid
Flammability	UL94V-0
RoHS	Compliant

Length:	Dia	Conductors	
		Signal	Power
2m	4.8mm	2 x 28AWG	2 x 24AWG
3m	5.0mm	2 x 28AWG	2 x 22AWG
5m	5.2mm	2 x 28AWG	2 x 20AWG

**PCB adaptor leads**

**Electrical**

No. of conductors	4
Current rating	1A
Voltage rating	30Vac (RMS)
Contact resistance	<10mΩ max.
PCB pitch	2.54mm

**Materials**

Moulding	Polycarbonate
Flammability	UL94V-0
Contact material	Copper Alloy
Contact plating	30 micro inch Gold
Wire insulation	PVC (black)
Flammability	UL94-V0
Conductors	4 x 28AWG
Operating temperature	0°C to +70°C
Mating cycles	1,000
RoHS	Compliant

**Cable construction - PXP6040, PXP6041**

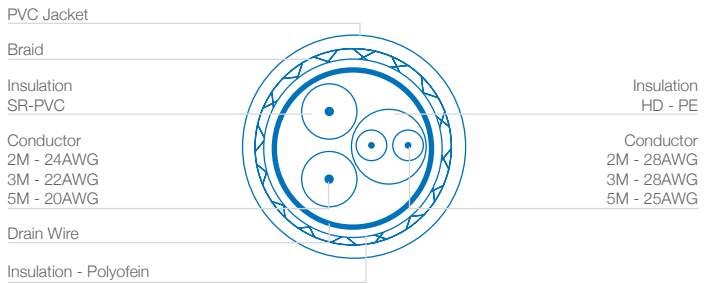

# BUCCANEER FOR DATA

## 6000 Series Ethernet Buccaneer

Thermo-plastic version



### Patch Cord Flex Connector - Pur Jacket Cable



PXP6037

- Mates with PXP6033TP type panel mounting connectors
- 30° twist locking
- Overmoulded patchcords with IP rated connector
- Supplied with shielded RJ45 plug
- Single or double end terminated
- Standard lengths: 2m, 3m&5m
- S-FTP cable construction
- PUR jacket cable
- Wiring configuration to 568-B
- Exceeds EIA/TIA Cat 5e

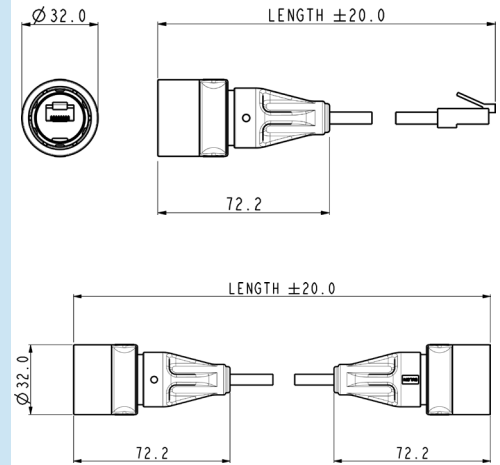

Part no	Type	Length	Description
PXP6037/2M00	Single ended	2m	IP RJ Buccaneer to Shielded RJ45
PXP6037/3M00	Single ended	3m	IP RJ Buccaneer to Shielded RJ45
PXP6037/5M00	Single ended	5m	IP RJ Buccaneer to Shielded RJ45
PXP6038/2M00	Double ended	2m	IP RJ Buccaneer to IP68 RJ Buccaneer
PXP6038/3M00	Double ended	3m	IP RJ Buccaneer to IP68 RJ Buccaneer
PXP6038/5M00	Double ended	5m	IP RJ Buccaneer to IP68 RJ Buccaneer

### Rewireable Flex Connector



PXP6034

- Mates with PXP6033TP type panel mounting connectors
- 30° twist locking
- Supplied with shielded RJ45 plug
- Two versions:  
for PUR jacket cable (Cat 5e)  
for other cable sizes from 4.0 to 10.0mm dia.

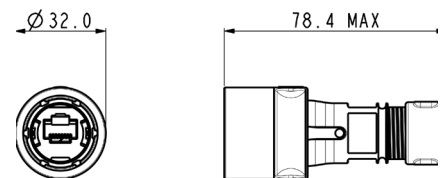

Part no	Description
PXP6034/A	Cable glands optimised for PUR jacket cable to maintain Cat 5e performance
PXP6034/B	Suitable for use with cables from 4.0 to 10.0mm diameter

### Front Panel Mounting Connector



PXP6033TP

- Sealed through panel
- Cat 5e shielded coupler
- Mates with all plastic flex connectors
- Standard RJ45 patchcord can be plugged into rear
- Version with earth wire available
- Single hole fixing
- Complete with panel sealing gasket

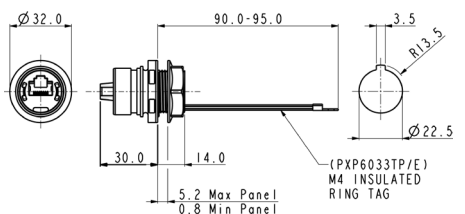

Part no	Description	Fixing
PXP6033TP	Cat 5e coupler	Front panel mounted - sealed through panel
PXP6033TP/E	Cat 5e coupler + earth wire	Front panel mounted - sealed through panel

BUCCANEER FOR DATA  
**6000 Series Ethernet Buccaneer**

- Metal version



Re-wireable Flex Connector



PXM6034

- Mates with PXM6033TP type panel mounting connectors
- 30° twist locking
- Supplied with shielded RJ45 plug
- Two versions:  
for PUR jacket cable (Cat 5e)  
for other cable sizes from 4.0 to 10.0mm dia.

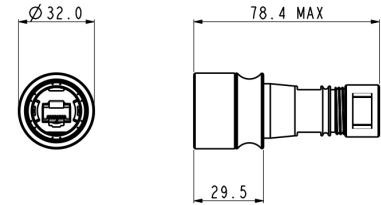

**Part no**

**Description**

PXM6034/A	Cable glands optimised for PUR jacket cable to maintain Cat 5e performance
PXM6034/B	Suitable for use with cables from 4.0 to 10.0mm diameter

Front Panel Mounting Connector



PXM6033

- Sealed through panel
- Cat 5e shielded coupler
- Mates with PXM6034 type flex connectors
- Standard RJ45 patchcord can be plugged into rear
- Connector shell ground to cable screen
- Single hole fixing
- Complete with panel sealing gasket

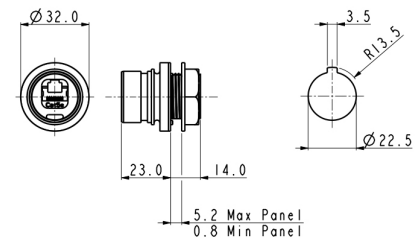

**Part no**

**Description**

**Fixing**

PXM6033TP	Cat 5e coupler	Front panel mounted - sealed through panel
-----------	----------------	--

Accessories For Ethernet Connectors



PXM6034

- Plastic connectors
- PXP6081 for cable connectors
  - PXP6034, PXP6037 & PXP6038
  - PXP6083 for front panel mount connectors PXP6033, with 30° twist lock

Sealing caps to maintain IP rating when connectors are not in use

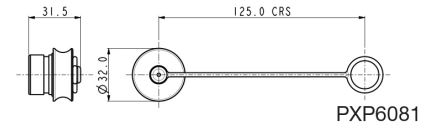

PXP6081

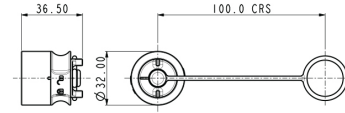

PXP6083

Part no	Description
PXP6081	Sealing Cap for plastic Flex cable connectors
PXP6083	Sealing Cap for plastic front panel mounting connector

Accessories For Ethernet Connectors



PXM6033

- Metal connectors
- PXM6081 for cable connectors
  - PXM6034
  - PXM6083 for front panel mount connectors

Sealing caps to maintain IP rating when connectors are not in use

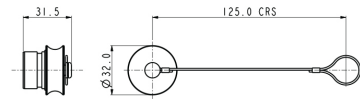

PXM6081

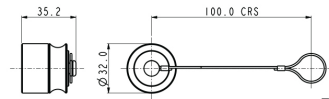

PXM6083

Part no	Description
PXM6081	Sealing Cap for metal Flex cable connectors
PXM6083	Sealing Cap for metal front panel mounting connector
14151	Hand crimp tooling + die set
14199	PUR Jacket cable - 50m reel
14150	Replacement shielded RJ45

BUCCANEER FOR DATA  
**6000 Series Ethernet Buccaneer**

Part No System



**Series Designation**

PXP - Plastic  
PXM - Metal

**Series / Body Style**

033 = Panel  
034 = Re-wireable Flex  
037 = Patchcord  
(Single Ended)  
038 = Patchcord  
(Double Ended)

**Panel Sealing**

TP = through panel sealing (for use  
with PXP6033 panel body only)  
  
Blank = not applicable

**Characteristics**

E = Earth lead (for use with PXP6033 plastic panel body only)  
A = Glanding for PUR cable (for use with PXP6034 re-wireable flex only)  
B = Glanding for 3.5 to 8mm cables (for use with PXP6034 re-wireable flex only)  
2M00 = 2 metre cable length (for use with PXP6037 and PXP6038 patchcords only)  
3M00 = 3 metre cable length (for use with PXP6037 and PXP6038 patchcords only)  
5M00 = 5 metre cable length (for use with PXP6037 and PXP6038 patchcords only)

**Examples**

PXP6033TP/E= Panel mounted coupler, sealed through panel with earth lead

PXP6037/2M00= Patchcord with one sealed end, 2 metres long

PXM6034/A = Flex re-wireable connector for use with PUR cable

PXM6033TP = Panel mounted coupler, through panel sealed

**Ethernet – Metal and Thermo-plastic versions**

**Connectors**

**Mechanical**

Sealing	IP69K, DIN40050-9 IP68, EN60529:1992+A2:2013 (10m depth for 2 weeks) IP66, EN60529:1992+A2:2013
Salt Mist:	EN60068-2-52 Test Kb Salt Mist (Cyclic) Marine Severity Level 1
Operating Temperature	
Re-wireable and Metal	-20°C to +70°C
Overmoulded patchcords	0°C to +70°C

**Materials - Overmoulded**

Overmould material	PVC (black)
Flammability rating	UL94V-0

**Materials - Re-wireable and Panel Connectors**

Plastic	PC/PBT
Metal	Machined Brass, Nickel Plated
Flammability rating	UL94V-0
'O' rings	Silicone
Panel Gasket - round	Silicone
Panel Gasket - flange	Silicone
Approvals	

RoHS	Compliant
------	-----------

**Stranded S-FTP Patch cord cable - PUR Jacket**

Polyurethane (PUR) jacket cable with internal construction exceeding Cat 5e performance levels. The PUR jacket has excellent abrasion, chemical and ozone resistance, low smoke, low halogen flame retardant construction suitable for internal and external industrial environments.

**Cable**

Conductors	24AWG (7/0.2mm) bare copper
Insulation	HD-PE
Pair	2 of the above cores twisted
Core	4 of the above cores
Tape	1 lap mylar tape
Screen	1 layer mylar and aluminium tape, 0.12mm tinned copper braid
Sheath	PUR Jacket Black
Op Temperature	-25°C to +85°C
Min. bend radius	10 x o/d (installation)
Min. bend radius	6 x o/d (installed)
Diameter	6.1mm nominal

**Electrical @ 20°C**

Characteristic Impedance	100Ω ±15Ω @ 100MHz
Capacitance	330pF/km
Conductor Loop resistance	29Ω/100m maximum
Skew	45 nsec/100m @ 100MHz
TIA/EIA Rating	Cat 5e

**Cable construction - PXP6037, PXP6038 and 14199**

**PCB adaptor leads**

**Electrical**

No. of conductors	4
Current rating	1A
Voltage rating	30Vac (RMS)
Contact resistance	<10mΩ max.
PCB pitch	2.54mm

**Materials**

Moulding	Polycarbonate
Flammability	UL94V-0
Contact material	Copper Alloy
Contact plating	30 micro inch Gold
Wire insulation	PVC (black)
Flammability	UL94-V0
Conductors	4 x 28AWG
Operating temperature	0°C to +70°C
Mating cycles	1,000
RoHS	Compliant

**Cable construction - PXP6040, PXP6041**

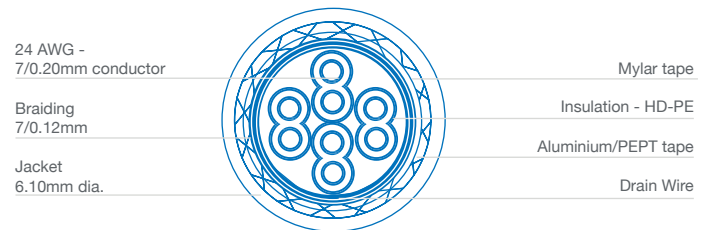

The M-Series Buccaneer range has been designed to offer flexible connectivity solutions for a variety of **industrial automation** applications. With metal and plastic variants, these **rugged** and **robust** interconnects are ideal for industries requiring **secure** and **reliable connections**.

- ⊕ Available types: M5, M8, M12, M16 & M23
- ⊕ Reliable sensor, actuator and data connectivity solutions
- ⊕ Straight and right angled configurations
- ⊕ Quick and secure screw coupling mechanism
- ⊕ Backwards compatible versions
- ⊕ Available as field attachable connectors, receptacles or with overmolded cables
- ⊕ Plastic and Metal Variants
- ⊕ Ratings from 1A, 30V ac/dc up to 8A, 250V ac/dc
- ⊕ Overmolded cables PVC & PUR
- ⊕ IP67 Rating
- ⊕ Cable lengths from 1m - 15m
- ⊕ A, B and D Coding Options
- ⊕ Power Distribution Units Available



M5 Series	106-110
M8 Series	111-119
M12 Series	120-131
M16 Series	132-135
M23 Series	136-138
M-Series Distribution Units	139-142



Bulgin's M-Series connector range is the ideal connectivity solution for **industrial automation** technologies that require fast, secure and reliable connections with a **high degree of environmental protection**.



Bulgin's automation interconnect range includes circular metric connectors with industry standard M5, M8, M12, M16 & M23 threads in addition to panel mount receptacles, overmolded cable variants and power/signal distributor units. This comprehensive product portfolio offers a large degree of flexibility with chemically and mechanically robust connectors that are easy to install, help decrease downtime and increase production efficiency in a wide range of markets.

## Applications include:

- Factory Automation
- Robotics
- Measurement & Instrumentation
- Manufacturing & Machine Tools
- Process Control Systems
- Medical
- Food & Beverage Processing
- Industrial Network

The most **compact connector** type in the M-Series range, Bulgin's **waterproof M5 sensor connectors** come in straight and angled forms with **PVC** or **PUR overmolded cable** options and a variety of panel mount receptacles.



With an industry standard screw coupling mechanism and IP67 rating, this circular connector product line is particularly suited to automotive, process control, commercial electronics & instrumentation applications that require reliable and robust miniature sensors.

## Key features:

- Secure & reliable screw locking mechanism
- Robust PVC & PUR overmolded cables
- Cable length from 1m - 15m
- High degree of environmental protection - IP67 rated
- Straight & right angled cable connectors
- Rear & front panel mount receptacles
- Available with 3 or 4 poles

M5 Rear Panel Mounting Female



PXMBNI05RPF

- Available in 3 and 4 poles
- PCB or flying lead termination
- Rear panel mounting M7 nut
- Available in 3 and 4 poles
- PCB or flying lead termination
- Mates with Flex Inline Body connectors

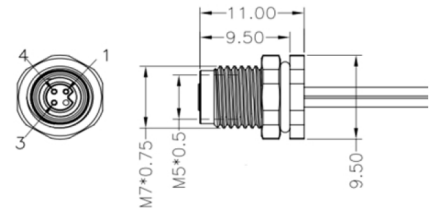

Part Number	Poles	Code	Termination	Lead Length
PXMBNI05RPF03AFL001	03	A	Flying Lead	100 mm
PXMBNI05RPF03AFL002	03	A	Flying Lead	200 mm
PXMBNI05RPF03AFL003	03	A	Flying Lead	300 mm
PXMBNI05RPF04AFL001	04	A	Flying Lead	100 mm
PXMBNI05RPF04AFL002	04	A	Flying Lead	200 mm
PXMBNI05RPF04AFL003	04	A	Flying Lead	300 mm
PXMBNI05RPF03APC	03	A	PCB Terminal	-
PXMBNI05RPF04APC	04	A	PCB Terminal	-

M5 Rear Panel Mounting Male



PXMBNI05RPM

- Available in 3 and 4 poles
- PCB or flying lead termination
- Rear panel mounting M5 nut
- Mates with Flex Body connectors

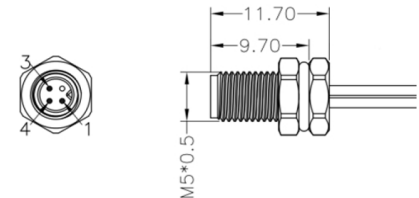

Part Number	Poles	Code	Termination	Lead Length
PXMBNI05RPM03AFL001	03	A	Flying Lead	100 mm
PXMBNI05RPM03AFL002	03	A	Flying Lead	200 mm
PXMBNI05RPM03AFL003	03	A	Flying Lead	300 mm
PXMBNI05RPM04AFL001	04	A	Flying Lead	100 mm
PXMBNI05RPM04AFL002	04	A	Flying Lead	200 mm
PXMBNI05RPM04AFL003	04	A	Flying Lead	300 mm
PXMBNI05RPM03APC	03	A	PCB Terminal	-
PXMBNI05RPM04APC	04	A	PCB Terminal	-

M5 Front Panel Mounting Male



PXMBNI05FPM

- Available in 3 and 4 poles
- PCB or flying lead termination
- Rear panel mounting M5
- Mates with Flex Body connectors

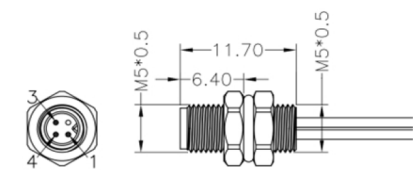

Part Number	Poles	Code	Termination	Lead Length
PXMBNI05FPM03AFL001	03	A	Flying Lead	100 mm
PXMBNI05FPM03AFL002	03	A	Flying Lead	200 mm
PXMBNI05FPM03AFL003	03	A	Flying Lead	300 mm
PXMBNI05FPM04AFL001	04	A	Flying Lead	100 mm
PXMBNI05FPM04AFL002	04	A	Flying Lead	200 mm
PXMBNI05FPM04AFL003	04	A	Flying Lead	300 mm
PXMBNI05FPM03APC	03	A	PCB Terminal	-
PXMBNI05FPM04APC	04	A	PCB Terminal	-

M5 Right Angled Female



PXPTPU05RAF  
PXPPVC05RAF

- Available in 3 and 4 poles
- 1,2,3,5,10 & 15M cable options
- Overmold Flex Body
- Mates with Flex Inline Body & panel mount connectors

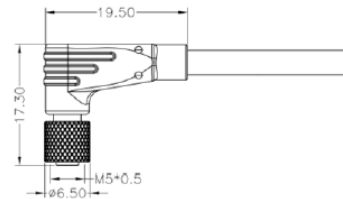

Part Number	Poles	Code	Termination	Lead Length	Cable Material
PXPPVC05RAF03ACL010PVC	03	A	Overmold Cable	1m	PVC
PXPTPU05RAF03ACL010PUR	03	A	Overmold Cable	1m	PUR
PXPPVC05RAF03ACL020PVC	03	A	Overmold Cable	2m	PVC
PXPTPU05RAF03ACL020PUR	03	A	Overmold Cable	2m	PUR
PXPPVC05RAF03ACL030PVC	03	A	Overmold Cable	3m	PVC
PXPTPU05RAF03ACL030PUR	03	A	Overmold Cable	3m	PUR
PXPPVC05RAF03ACL050PVC	03	A	Overmold Cable	5m	PVC
PXPTPU05RAF03ACL050PUR	03	A	Overmold Cable	5m	PUR
PXPPVC05RAF03ACL100PVC	03	A	Overmold Cable	10m	PVC
PXPTPU05RAF03ACL100PUR	03	A	Overmold Cable	10m	PUR
PXPPVC05RAF03ACL150PVC	03	A	Overmold Cable	15m	PVC
PXPTPU05RAF03ACL150PUR	03	A	Overmold Cable	15m	PUR
PXPPVC05RAF04ACL010PVC	04	A	Overmold Cable	1m	PVC
PXPTPU05RAF04ACL010PUR	04	A	Overmold Cable	1m	PUR
PXPPVC05RAF04ACL020PVC	04	A	Overmold Cable	2m	PVC
PXPTPU05RAF04ACL020PUR	04	A	Overmold Cable	2m	PUR
PXPPVC05RAF04ACL030PVC	04	A	Overmold Cable	3m	PVC
PXPTPU05RAF04ACL030PUR	04	A	Overmold Cable	3m	PUR
PXPPVC05RAF04ACL050PVC	04	A	Overmold Cable	5m	PVC
PXPTPU05RAF04ACL050PUR	04	A	Overmold Cable	5m	PUR
PXPPVC05RAF04ACL100PVC	04	A	Overmold Cable	10m	PVC
PXPTPU05RAF04ACL100PUR	04	A	Overmold Cable	10m	PUR
PXPPVC05RAF04ACL150PVC	04	A	Overmold Cable	15m	PVC
PXPTPU05RAF04ACL150PUR	04	A	Overmold Cable	15m	PUR

M5 Right Angled Male



PXPTPU05RAM  
PXPPVC05RAM

- Available in 3 and 4 poles
- 1,2,3,5,10 & 15M cable options
- Overmold Flex Inline Body
- Mates with Flex Body & panel mount connectors

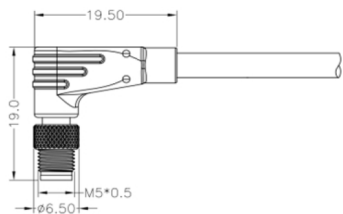

Part Number	Poles	Code	Termination	Lead Length	Cable Material
PXPPVC05RAM03ACL010PVC	03	A	Overmold Cable	1m	PVC
PXPTPU05RAM03ACL010PUR	03	A	Overmold Cable	1m	PUR
PXPPVC05RAM03ACL020PVC	03	A	Overmold Cable	2m	PVC
PXPTPU05RAM03ACL020PUR	03	A	Overmold Cable	2m	PUR
PXPPVC05RAM03ACL030PVC	03	A	Overmold Cable	3m	PVC
PXPTPU05RAM03ACL030PUR	03	A	Overmold Cable	3m	PUR
PXPPVC05RAM03ACL050PVC	03	A	Overmold Cable	5m	PVC
PXPTPU05RAM03ACL050PUR	03	A	Overmold Cable	5m	PUR
PXPPVC05RAM03ACL100PVC	03	A	Overmold Cable	10m	PVC
PXPTPU05RAM03ACL100PUR	03	A	Overmold Cable	10m	PUR
PXPPVC05RAM03ACL150PVC	03	A	Overmold Cable	15m	PVC
PXPTPU05RAM03ACL150PUR	03	A	Overmold Cable	15m	PUR
PXPPVC05RAM04ACL010PVC	04	A	Overmold Cable	1m	PVC
PXPTPU05RAM04ACL010PUR	04	A	Overmold Cable	1m	PUR
PXPPVC05RAM04ACL020PVC	04	A	Overmold Cable	2m	PVC
PXPTPU05RAM04ACL020PUR	04	A	Overmold Cable	2m	PUR
PXPPVC05RAM04ACL030PVC	04	A	Overmold Cable	3m	PVC
PXPTPU05RAM04ACL030PUR	04	A	Overmold Cable	3m	PUR
PXPPVC05RAM04ACL050PVC	04	A	Overmold Cable	5m	PVC
PXPTPU05RAM04ACL050PUR	04	A	Overmold Cable	5m	PUR
PXPPVC05RAM04ACL100PVC	04	A	Overmold Cable	10m	PVC
PXPTPU05RAM04ACL100PUR	04	A	Overmold Cable	10m	PUR
PXPPVC05RAM04ACL150PVC	04	A	Overmold Cable	15m	PVC
PXPTPU05RAM04ACL150PUR	04	A	Overmold Cable	15m	PUR

M5 Flex Body Female



PXPTPU05FBF  
PXPPVC05FBF

- Available in 3 and 4 poles
- Overmold Flex Body
- 1,2,3,5,10 & 15M cable options
- Mates with Flex Inline Body & panel mount connectors

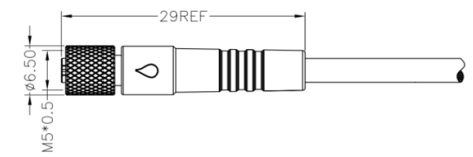

Part Number	Poles	Code	Termination	Lead Length	Cable Material
PXPPVC05FBF03ACL010PVC	03	A	Overmold Cable	1m	PVC
PXPTPU05FBF03ACL010PUR	03	A	Overmold Cable	1m	PUR
PXPPVC05FBF03ACL020PVC	03	A	Overmold Cable	2m	PVC
PXPTPU05FBF03ACL020PUR	03	A	Overmold Cable	2m	PUR
PXPPVC05FBF03ACL030PVC	03	A	Overmold Cable	3m	PVC
PXPTPU05FBF03ACL030PUR	03	A	Overmold Cable	3m	PUR
PXPPVC05FBF03ACL050PVC	03	A	Overmold Cable	5m	PVC
PXPTPU05FBF03ACL050PUR	03	A	Overmold Cable	5m	PUR
PXPPVC05FBF03ACL100PVC	03	A	Overmold Cable	10m	PVC
PXPTPU05FBF03ACL100PUR	03	A	Overmold Cable	10m	PUR
PXPPVC05FBF03ACL150PVC	03	A	Overmold Cable	15m	PVC
PXPTPU05FBF03ACL150PUR	03	A	Overmold Cable	15m	PUR
PXPPVC05FBF04ACL010PVC	04	A	Overmold Cable	1m	PVC
PXPTPU05FBF04ACL010PUR	04	A	Overmold Cable	1m	PUR
PXPPVC05FBF04ACL020PVC	04	A	Overmold Cable	2m	PVC
PXPTPU05FBF04ACL020PUR	04	A	Overmold Cable	2m	PUR
PXPPVC05FBF04ACL030PVC	04	A	Overmold Cable	3m	PVC
PXPTPU05FBF04ACL030PUR	04	A	Overmold Cable	3m	PUR
PXPPVC05FBF04ACL050PVC	04	A	Overmold Cable	5m	PVC
PXPTPU05FBF04ACL050PUR	04	A	Overmold Cable	5m	PUR
PXPPVC05FBF04ACL100PVC	04	A	Overmold Cable	10m	PVC
PXPTPU05FBF04ACL100PUR	04	A	Overmold Cable	10m	PUR
PXPPVC05FBF04ACL150PVC	04	A	Overmold Cable	15m	PVC
PXPTPU05FBF04ACL150PUR	04	A	Overmold Cable	15m	PUR

M5 Flex Inline Body Male



PXPTPU05FIM  
PXPPVC05FIM

- Available in 3 and 4 poles
- 1,2,3,5,10 & 15M cable options
- Overmold Flex Inline Body
- Mates with Flex Body & panel mount connectors



Part Number	Poles	Code	Termination	Lead Length	Cable Material
PXPPVC05FIM03ACL010PVC	03	A	Overmold Cable	1m	PVC
PXPTPU05FIM03ACL010PUR	03	A	Overmold Cable	1m	PUR
PXPPVC05FIM03ACL020PVC	03	A	Overmold Cable	2m	PVC
PXPTPU05FIM03ACL020PUR	03	A	Overmold Cable	2m	PUR
PXPPVC05FIM03ACL030PVC	03	A	Overmold Cable	3m	PVC
PXPTPU05FIM03ACL030PUR	03	A	Overmold Cable	3m	PUR
PXPPVC05FIM03ACL050PVC	03	A	Overmold Cable	5m	PVC
PXPTPU05FIM03ACL050PUR	03	A	Overmold Cable	5m	PUR
PXPPVC05FIM03ACL100PVC	03	A	Overmold Cable	10m	PVC
PXPTPU05FIM03ACL100PUR	03	A	Overmold Cable	10m	PUR
PXPPVC05FIM03ACL150PVC	03	A	Overmold Cable	15m	PVC
PXPTPU05FIM03ACL150PUR	03	A	Overmold Cable	15m	PUR
PXPPVC05FIM04ACL010PVC	04	A	Overmold Cable	1m	PVC
PXPTPU05FIM04ACL010PUR	04	A	Overmold Cable	1m	PUR
PXPPVC05FIM04ACL020PVC	04	A	Overmold Cable	2m	PVC
PXPTPU05FIM04ACL020PUR	04	A	Overmold Cable	2m	PUR
PXPPVC05FIM04ACL030PVC	04	A	Overmold Cable	3m	PVC
PXPTPU05FIM04ACL030PUR	04	A	Overmold Cable	3m	PUR
PXPPVC05FIM04ACL050PVC	04	A	Overmold Cable	5m	PVC
PXPTPU05FIM04ACL050PUR	04	A	Overmold Cable	5m	PUR
PXPPVC05FIM04ACL100PVC	04	A	Overmold Cable	10m	PVC
PXPTPU05FIM04ACL100PUR	04	A	Overmold Cable	10m	PUR
PXPPVC05FIM04ACL150PVC	04	A	Overmold Cable	15m	PVC
PXPTPU05FIM04ACL150PUR	04	A	Overmold Cable	15m	PUR

**Electrical**

No. Poles:	3	4
Current Rating:	1A	1A
Voltage Rating (ac/dc) :	60V	60V
Contact Resistance:	<10mΩ	
Insulation Resistance:	>100MΩ	
AC Breakdown Voltage:		
3 Pole	1.5KV	
4 Pole	1.5KV	
Operating Temp Range:	-25°C to 80°C	

**Mechanical:**

Locking Mechanism:	Screw coupling
Sealing:	IP67
Terminations:	
3 Pole	Single wire / PCB / Cable
4 Pole	Single wire / PCB / Cable
Mechanical Operation:	500 mating cycles
Diameter over coupling ring:	6.5mm

**Materials:**

Body:	Nickel Plated Brass
Coupling Nut:	Nickel Plated Brass
Colour:	Grey
Pin Contacts:	Brass, Gold plating
Socket Contacts:	Phosphor Bronze, Gold plating
O Rings & Gaskets:	Viton
RoHS:	Compliant

**Panel Mount:**

Body:	Nickel Plated Brass
Coupling Nut:	Nickel Plated Brass
Colour:	Grey
Pin Contacts:	Brass, Gold plating
Socket Contacts:	Phosphor Bronze, Gold plating
O Rings & Gaskets:	Viton
RoHS:	Compliant

**Cable Connectors:**

Body:	TPU / PVC
Coupling Nut:	Nickel Plated Brass
Colour:	Black
Pin Contacts:	Brass, Gold plating
Socket Contacts:	Phosphor Bronze, Gold plating
O Rings & Gaskets:	Viton
RoHS:	Compliant

<b>MX</b>	<b>XXX</b>	<b>XX</b>	<b>XX</b>	<b>X</b>	<b>XXX</b>	<b>X</b>	<b>XX</b>
<b>Series</b>	<b>Material</b>	<b>Series Size</b>	<b>Body Style</b>	<b>Orientation</b>	<b>NO. Contacts</b>	<b>Code</b>	<b>Termination</b>
PXM	BNI = Brass Nickel	05	FB = Flex Body	M	03	A	PC = PCB
PXP	TPU = overmold for PUR PVC = overmold for PVC		FI = Flex Inline Body FP = Front Panel Mounting RP = Rear Panel Mounting RA = Right Angle	F	04		FL = Flying Lead CL = Cable

<b>XXX</b>	<b>XXX</b>
<b>Lead Length</b>	<b>Cable Material</b>
001	PUR
002	PVC
003	
010	
030	
050	
100	
150	

Bulgin's **M8 circular connectors** and overmolded cables are designed to fulfil the ever growing demand for **sensor**, **actuator** and **data connections** in process control, industrial machinery and factory automation applications.



These compact sensor and automation connectors with screw lock coupling are mechanically and chemically robust, easy to install, minimise downtime and help to increase production efficiency. Rated to the IP67 standard, Bulgin's M8 Series ensure safe, secure and reliable protection from liquids, dust, moisture and dirt whilst also providing great resistance against vibrations to ensure that connections are not disrupted.

## Key features:

- Straight & right angled configurations
- 3, 4 or 5 contacts
- Metal & plastic shell options
- A & B coded
- Environmental protection class IP67
- Field installable connectors, panel mounts & overmolded cable options
- PVC or PUR jacketed cable variants with many lengths from 1m – 15m

M8 Rear Panel Mounting Male



PXMBNI08RPM

- Available in 3, 4 and 5 poles
- PCB or flying lead termination
- Rear panel mounting M8
- Mates with Flex Body connectors

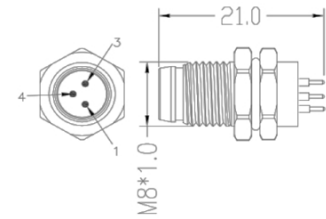

Part Number	Poles	Code	Termination	Lead Length
PXMBNI08RPM03APC	03	A	PCB Terminal	-
PXMBNI08RPM04APC	04	A	PCB Terminal	-
PXMBNI08RPM05BPC	05	B	PCB Terminal	-
PXMBNI08RPM03AFL001	03	A	Flying Lead	100mm
PXMBNI08RPM03AFL002	03	A	Flying Lead	200mm
PXMBNI08RPM03AFL003	03	A	Flying Lead	300mm
PXMBNI08RPM04AFL001	04	A	Flying Lead	100mm
PXMBNI08RPM04AFL002	04	A	Flying Lead	200mm
PXMBNI08RPM04AFL003	04	A	Flying Lead	300mm
PXMBNI08RPM05BFL001	05	B	Flying Lead	100mm
PXMBNI08RPM05BFL002	05	B	Flying Lead	200mm
PXMBNI08RPM05BFL003	05	B	Flying Lead	300mm

M8 Rear Panel Mounting Female



PXMBNI08RPF

- Available in 3, 4 and 5 poles
- PCB or flying lead termination
- Rear panel mounting M11 nut
- Mates with Flex Inline Body connectors

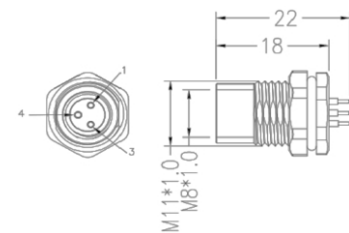

Part Number	Poles	Code	Termination	Lead Length
PXMBNI08RPF03APC	03	A	PCB Terminal	-
PXMBNI08RPF04APC	04	A	PCB Terminal	-
PXMBNI08RPF05BPC	05	B	PCB Terminal	-
PXMBNI08RPF03AFL001	03	A	Flying Lead	100mm
PXMBNI08RPF03AFL002	03	A	Flying Lead	200mm
PXMBNI08RPF03AFL003	03	A	Flying Lead	300mm
PXMBNI08RPF04AFL001	04	A	Flying Lead	100mm
PXMBNI08RPF04AFL002	04	A	Flying Lead	200mm
PXMBNI08RPF04AFL003	04	A	Flying Lead	300mm
PXMBNI08RPF05BFL001	05	B	Flying Lead	100mm
PXMBNI08RPF05BFL002	05	B	Flying Lead	200mm
PXMBNI08RPF05BFL003	05	B	Flying Lead	300mm



M8 Front Panel Mounting Female



PXMBNI08FPF

- Available in 3, 4 and 5 poles
- Flying lead termination
- Front panel mounting M8
- Mates with Flex Inline Body connectors

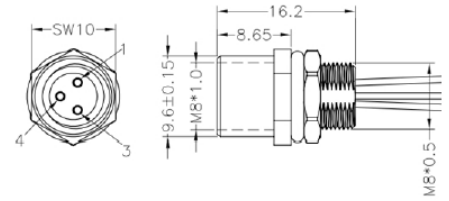

Part Number	Poles	Code	Termination	Lead Length
PXMBNI08FPF03AFL001	03	A	Flying Lead	100mm
PXMBNI08FPF03AFL002	03	A	Flying Lead	200mm
PXMBNI08FPF03AFL003	03	B	Flying Lead	300mm
PXMBNI08FPF04AFL001	04	A	Flying Lead	100mm
PXMBNI08FPF04AFL002	04	A	Flying Lead	200mm
PXMBNI08FPF04AFL003	04	A	Flying Lead	300mm
PXMBNI08FPF05BFL001	05	B	Flying Lead	100mm
PXMBNI08FPF05BFL002	05	B	Flying Lead	200mm
PXMBNI08FPF05BFL003	05	B	Flying Lead	300mm

M8 Front Panel Mounting Male



PXMBNI08FPM

- Available in 3, 4 and 5 poles
- Flying lead termination
- Front panel mounting M8
- Mates with Flex Body connectors

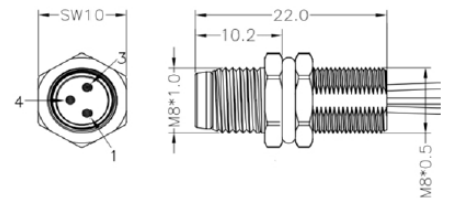

Part Number	Poles	Code	Termination	Lead Length
PXMBNI08FPM03AFL001	03	A	Flying Lead	100mm
PXMBNI08FPM03AFL002	03	A	Flying Lead	200mm
PXMBNI08FPM03AFL003	03	A	Flying Lead	300mm
PXMBNI08FPM04AFL001	04	A	Flying Lead	100mm
PXMBNI08FPM04AFL002	04	A	Flying Lead	200mm
PXMBNI08FPM04AFL003	04	A	Flying Lead	300mm
PXMBNI08FPM05BFL001	05	B	Flying Lead	100mm
PXMBNI08FPM05BFL002	05	B	Flying Lead	200mm
PXMBNI08FPM05BFL003	05	B	Flying Lead	300mm

M8 Flex Inline Body Male



PXPPAM08FIM

- Available in 3 and 4 poles
- Screw termination
- Plastic Flex Inline Body
- Mates with Flex Body and panel mount connectors

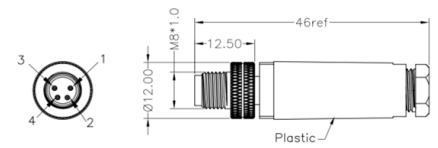

Part Number	Poles	Code	Termination
PXPPAM08FIM03AST	03	A	Screw Terminal
PXPPAM08FIM04AST	04	A	Screw Terminal

M8 Flex Body Female



PXPPAM08FBF

- Available in 3 and 4 poles
- Screw termination
- Plastic Flex Body
- Mates with Flex Inline Body and panel mount connectors

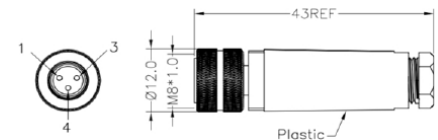

Part Number	Poles	Code	Termination
PXPPAM08FBF03AST	03	A	Screw Terminal
PXPPAM08FBF04AST	04	A	Screw Terminal

Brass - Nickel Plating M8 Flex Inline Body Male



PXMBNI08FIM

- Available in 3, 4 and 5 poles
- Solder termination
- Metal Flex Inline Body
- Mates with Flex Body and panel mount connectors

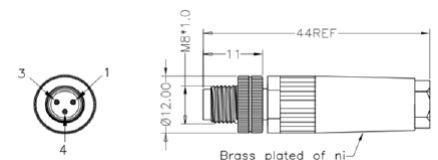

Part Number	Poles	Code	Termination
PXMBNI08FIM03ASC	03	A	Solder Terminal
PXMBNI08FIM04ASC	04	A	Solder Terminal
PXMBNI08FIM05BSC	05	B	Solder Terminal

Brass - Nickel Plating M8 Flex Body Female



PXMBNI08FBF

- Available in 3, 4 and 5 poles
- Solder termination
- Metal Flex Body
- Mates with Flex Inline Body and panel mount connectors

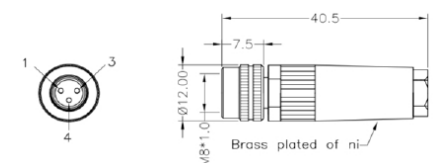

Part Number	Poles	Code	Termination
PXMBNI08FBF03ASC	03	A	Solder Terminal
PXMBNI08FBF04ASC	04	A	Solder Terminal
PXMBNI08FBF05BSC	05	B	Solder Terminal

M8 Right Angled Female



PXPTPU08RAF  
PXPPVC08RAF

- Available in 3, 4 and 5 poles
- 1,2,3,5,10 & 15M cable options
- Overmold Flex Body
- Mates with Flex Inline Body & panel mount connectors

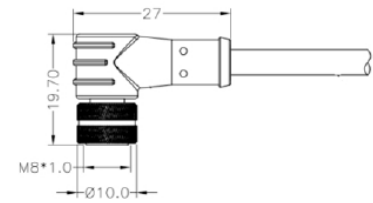

Part Number	Poles	Code	Termination	Lead Length	Cable Material
PXPPVC08RAF03ACL010PVC	03	A	Overmold Cable	1m	PVC
PXPTPU08RAF03ACL010PUR	03	A	Overmold Cable	1m	PUR
PXPPVC08RAF03ACL020PVC	03	A	Overmold Cable	2m	PVC
PXPTPU08RAF03ACL020PUR	03	A	Overmold Cable	2m	PUR
PXPPVC08RAF03ACL030PVC	03	A	Overmold Cable	3m	PVC
PXPTPU08RAF03ACL030PUR	03	A	Overmold Cable	3m	PUR
PXPPVC08RAF03ACL050PVC	03	A	Overmold Cable	5m	PVC
PXPTPU08RAF03ACL050PUR	03	A	Overmold Cable	5m	PUR
PXPPVC08RAF03ACL100PVC	03	A	Overmold Cable	10m	PVC
PXPTPU08RAF03ACL100PUR	03	A	Overmold Cable	10m	PUR
PXPPVC08RAF03ACL150PVC	03	A	Overmold Cable	15m	PVC
PXPTPU08RAF03ACL150PUR	03	A	Overmold Cable	15m	PUR
PXPPVC08RAF04ACL010PVC	04	A	Overmold Cable	1m	PVC
PXPTPU08RAF04ACL010PUR	04	A	Overmold Cable	1m	PUR
PXPPVC08RAF04ACL020PVC	04	A	Overmold Cable	2m	PVC
PXPTPU08RAF04ACL020PUR	04	A	Overmold Cable	2m	PUR
PXPPVC08RAF04ACL030PVC	04	A	Overmold Cable	3m	PVC
PXPTPU08RAF04ACL030PUR	04	A	Overmold Cable	3m	PUR
PXPPVC08RAF04ACL050PVC	04	A	Overmold Cable	5m	PVC
PXPTPU08RAF04ACL050PUR	04	A	Overmold Cable	5m	PUR
PXPPVC08RAF04ACL100PVC	04	A	Overmold Cable	10m	PVC
PXPTPU08RAF04ACL100PUR	04	A	Overmold Cable	10m	PUR
PXPPVC08RAF04ACL150PVC	04	A	Overmold Cable	15m	PVC
PXPTPU08RAF04ACL150PUR	04	A	Overmold Cable	15m	PUR
PXPPVC08RAF05BCL010PVC	05	B	Overmold Cable	1m	PVC
PXPTPU08RAF05BCL010PUR	05	B	Overmold Cable	1m	PUR
PXPPVC08RAF05BCL020PVC	05	B	Overmold Cable	2m	PVC
PXPTPU08RAF05BCL020PUR	05	B	Overmold Cable	2m	PUR
PXPPVC08RAF05BCL030PVC	05	B	Overmold Cable	3m	PVC
PXPTPU08RAF05BCL030PUR	05	B	Overmold Cable	3m	PUR
PXPPVC08RAF05BCL050PVC	05	B	Overmold Cable	5m	PVC
PXPTPU08RAF05BCL050PUR	05	B	Overmold Cable	5m	PUR
PXPPVC08RAF05BCL100PVC	05	B	Overmold Cable	10m	PVC
PXPTPU08RAF05BCL100PUR	05	B	Overmold Cable	10m	PUR
PXPPVC08RAF05BCL150PVC	05	B	Overmold Cable	15m	PVC
PXPTPU08RAF05BCL150PUR	05	B	Overmold Cable	15m	PUR

M8 Right Angled Male



PXPTPU08RAM  
PXPPVC08RAM

- Available in 3, 4 and 5 poles
- 1,2,3,5,10 & 15M cable options
- Overmold Flex Inline Body
- Mates with Flex Body & panel mount connectors

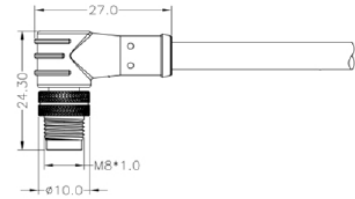

Part Number	Poles	Code	Termination	Lead Length	Cable Material
PXPPVC08RAM03ACL010PVC	03	A	Overmold Cable	1m	PVC
PXPTPU08RAM03ACL010PUR	03	A	Overmold Cable	1m	PUR
PXPPVC08RAM03ACL020PVC	03	A	Overmold Cable	2m	PVC
PXPTPU08RAM03ACL020PUR	03	A	Overmold Cable	2m	PUR
PXPPVC08RAM03ACL030PVC	03	A	Overmold Cable	3m	PVC
PXPTPU08RAM03ACL030PUR	03	A	Overmold Cable	3m	PUR
PXPPVC08RAM03ACL050PVC	03	A	Overmold Cable	5m	PVC
PXPTPU08RAM03ACL050PUR	03	A	Overmold Cable	5m	PUR
PXPPVC08RAM03ACL100PVC	03	A	Overmold Cable	10m	PVC
PXPTPU08RAM03ACL100PUR	03	A	Overmold Cable	10m	PUR
PXPPVC08RAM03ACL150PVC	03	A	Overmold Cable	15m	PVC
PXPTPU08RAM03ACL150PUR	03	A	Overmold Cable	15m	PUR
PXPPVC08RAM04ACL010PVC	04	A	Overmold Cable	1m	PVC
PXPTPU08RAM04ACL010PUR	04	A	Overmold Cable	1m	PUR
PXPPVC08RAM04ACL020PVC	04	A	Overmold Cable	2m	PVC
PXPTPU08RAM04ACL020PUR	04	A	Overmold Cable	2m	PUR
PXPPVC08RAM04ACL030PVC	04	A	Overmold Cable	3m	PVC
PXPTPU08RAM04ACL030PUR	04	A	Overmold Cable	3m	PUR
PXPPVC08RAM04ACL050PVC	04	A	Overmold Cable	5m	PVC
PXPTPU08RAM04ACL050PUR	04	A	Overmold Cable	5m	PUR
PXPPVC08RAM04ACL100PVC	04	A	Overmold Cable	10m	PVC
PXPTPU08RAM04ACL100PUR	04	A	Overmold Cable	10m	PUR
PXPPVC08RAM04ACL150PVC	04	A	Overmold Cable	15m	PVC
PXPTPU08RAM04ACL150PUR	04	A	Overmold Cable	15m	PUR
PXPPVC08RAM05BCL010PVC	05	B	Overmold Cable	1m	PVC
PXPTPU08RAM05BCL010PUR	05	B	Overmold Cable	1m	PUR
PXPPVC08RAM05BCL020PVC	05	B	Overmold Cable	2m	PVC
PXPTPU08RAM05BCL020PUR	05	B	Overmold Cable	2m	PUR
PXPPVC08RAM05BCL030PVC	05	B	Overmold Cable	3m	PVC
PXPTPU08RAM05BCL030PUR	05	B	Overmold Cable	3m	PUR
PXPPVC08RAM05BCL050PVC	05	B	Overmold Cable	5m	PVC
PXPTPU08RAM05BCL050PUR	05	B	Overmold Cable	5m	PUR
PXPPVC08RAM05BCL100PVC	05	B	Overmold Cable	10m	PVC
PXPTPU08RAM05BCL100PUR	05	B	Overmold Cable	10m	PUR
PXPPVC08RAM05BCL150PVC	05	B	Overmold Cable	15m	PVC
PXPTPU08RAM05BCL150PUR	05	B	Overmold Cable	15m	PUR

M8 Flex Body Female



PXPTPU08FBF  
PXPPVC08FBF

- Available in 3, 4 and 5 poles
- 1,2,3,5,10 & 15M cable options
- Overmold Flex Body
- Mates with Flex Inline Body & panel mount connectors

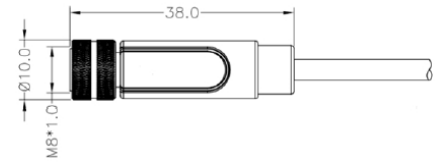

Part Number	Poles	Code	Termination	Lead Length	Cable Material
PXPPVC08FBF03ACL010PVC	03	A	Overmold Cable	1m	PVC
PXPTPU08FBF03ACL010PUR	03	A	Overmold Cable	1m	PUR
PXPPVC08FBF03ACL020PVC	03	A	Overmold Cable	2m	PVC
PXPTPU08FBF03ACL020PUR	03	A	Overmold Cable	2m	PUR
PXPPVC08FBF03ACL030PVC	03	A	Overmold Cable	3m	PVC
PXPTPU08FBF03ACL030PUR	03	A	Overmold Cable	3m	PUR
PXPPVC08FBF03ACL050PVC	03	A	Overmold Cable	5m	PVC
PXPTPU08FBF03ACL050PUR	03	A	Overmold Cable	5m	PUR
PXPPVC08FBF03ACL100PVC	03	A	Overmold Cable	10m	PVC
PXPTPU08FBF03ACL100PUR	03	A	Overmold Cable	10m	PUR
PXPPVC08FBF03ACL150PVC	03	A	Overmold Cable	15m	PVC
PXPTPU08FBF03ACL150PUR	03	A	Overmold Cable	15m	PUR
PXPPVC08FBF04ACL010PVC	04	A	Overmold Cable	1m	PVC
PXPTPU08FBF04ACL010PUR	04	A	Overmold Cable	1m	PUR
PXPPVC08FBF04ACL020PVC	04	A	Overmold Cable	2m	PVC
PXPTPU08FBF04ACL020PUR	04	A	Overmold Cable	2m	PUR
PXPPVC08FBF04ACL030PVC	04	A	Overmold Cable	3m	PVC
PXPTPU08FBF04ACL030PUR	04	A	Overmold Cable	3m	PUR
PXPPVC08FBF04ACL050PVC	04	A	Overmold Cable	5m	PVC
PXPTPU08FBF04ACL050PUR	04	A	Overmold Cable	5m	PUR
PXPPVC08FBF04ACL100PVC	04	A	Overmold Cable	10m	PVC
PXPTPU08FBF04ACL100PUR	04	A	Overmold Cable	10m	PUR
PXPPVC08FBF04ACL150PVC	04	A	Overmold Cable	15m	PVC
PXPTPU08FBF04ACL150PUR	04	A	Overmold Cable	15m	PUR
PXPPVC08FBF05BCL010PVC	05	B	Overmold Cable	1m	PVC
PXPTPU08FBF05BCL010PUR	05	B	Overmold Cable	1m	PUR
PXPPVC08FBF05BCL020PVC	05	B	Overmold Cable	2m	PVC
PXPTPU08FBF05BCL020PUR	05	B	Overmold Cable	2m	PUR
PXPPVC08FBF05BCL030PVC	05	B	Overmold Cable	3m	PVC
PXPTPU08FBF05BCL030PUR	05	B	Overmold Cable	3m	PUR
PXPPVC08FBF05BCL050PVC	05	B	Overmold Cable	5m	PVC
PXPTPU08FBF05BCL050PUR	05	B	Overmold Cable	5m	PUR
PXPPVC08FBF05BCL100PVC	05	B	Overmold Cable	10m	PVC
PXPTPU08FBF05BCL100PUR	05	B	Overmold Cable	10m	PUR
PXPPVC08FBF05BCL150PVC	05	B	Overmold Cable	15m	PVC
PXPTPU08FBF05BCL150PUR	05	B	Overmold Cable	15m	PUR

M8 Flex Inline Body Male



PXPTPU08FIM  
PXPPVC08FIM

- Available in 3, 4 and 5 poles
- 1,2,3,5,10 & 15M cable options
- Overmold Flex Inline Body
- Mates with Flex Body & panel mount connectors

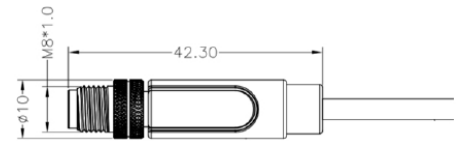

Part Number	Poles	Code	Termination	Lead Length	Cable Material
PXPPVC08FIM03ACL010PVC	03	A	Overmold Cable	1m	PVC
PXPTPU08FIM03ACL010PUR	03	A	Overmold Cable	1m	PUR
PXPPVC08FIM03ACL020PVC	03	A	Overmold Cable	2m	PVC
PXPTPU08FIM03ACL020PUR	03	A	Overmold Cable	2m	PUR
PXPPVC08FIM03ACL030PVC	03	A	Overmold Cable	3m	PVC
PXPTPU08FIM03ACL030PUR	03	A	Overmold Cable	3m	PUR
PXPPVC08FIM03ACL050PVC	03	A	Overmold Cable	5m	PVC
PXPTPU08FIM03ACL050PUR	03	A	Overmold Cable	5m	PUR
PXPPVC08FIM03ACL100PVC	03	A	Overmold Cable	10m	PVC
PXPTPU08FIM03ACL100PUR	03	A	Overmold Cable	10m	PUR
PXPPVC08FIM03ACL150PVC	03	A	Overmold Cable	15m	PVC
PXPTPU08FIM03ACL150PUR	03	A	Overmold Cable	15m	PUR
PXPPVC08FIM04ACL010PVC	04	A	Overmold Cable	1m	PVC
PXPTPU08FIM04ACL010PUR	04	A	Overmold Cable	1m	PUR
PXPPVC08FIM04ACL020PVC	04	A	Overmold Cable	2m	PVC
PXPTPU08FIM04ACL020PUR	04	A	Overmold Cable	2m	PUR
PXPPVC08FIM04ACL030PVC	04	A	Overmold Cable	3m	PVC
PXPTPU08FIM04ACL030PUR	04	A	Overmold Cable	3m	PUR
PXPPVC08FIM04ACL050PVC	04	A	Overmold Cable	5m	PVC
PXPTPU08FIM04ACL050PUR	04	A	Overmold Cable	5m	PUR
PXPPVC08FIM04ACL100PVC	04	A	Overmold Cable	10m	PVC
PXPTPU08FIM04ACL100PUR	04	A	Overmold Cable	10m	PUR
PXPPVC08FIM04ACL150PVC	04	A	Overmold Cable	15m	PVC
PXPTPU08FIM04ACL150PUR	04	A	Overmold Cable	15m	PUR
PXPPVC08FIM05BCL010PVC	05	B	Overmold Cable	1m	PVC
PXPTPU08FIM05BCL010PUR	05	B	Overmold Cable	1m	PUR
PXPPVC08FIM05BCL020PVC	05	B	Overmold Cable	2m	PVC
PXPTPU08FIM05BCL020PUR	05	B	Overmold Cable	2m	PUR
PXPPVC08FIM05BCL030PVC	05	B	Overmold Cable	3m	PVC
PXPTPU08FIM05BCL030PUR	05	B	Overmold Cable	3m	PUR
PXPPVC08FIM05BCL050PVC	05	B	Overmold Cable	5m	PVC
PXPTPU08FIM05BCL050PUR	05	B	Overmold Cable	5m	PUR
PXPPVC08FIM05BCL100PVC	05	B	Overmold Cable	10m	PVC
PXPTPU08FIM05BCL100PUR	05	B	Overmold Cable	10m	PUR
PXPPVC08FIM05BCL150PVC	05	B	Overmold Cable	15m	PVC
PXPTPU08FIM05BCL150PUR	05	B	Overmold Cable	15m	PUR

**Electrical**

No. Poles:	3	4	5
Current Rating:	3A	3A	1.5A
Voltage Rating (ac/dc) :	60V	30V	30V
Contact Resistance:	<10mΩ		
Insulation Resistance:	>100MΩ		
AC Breakdown Voltage:			
3 Pole	1.5KV		
4 Pole	0.8KV		
5 Pole	0.8KV		
Operating Temp Range:	-25°C to 80°C		

**Mechanical:**

Locking Mechanism:	Screw coupling
Sealing:	IP67
Contact Accomodation:	
3, 4 & 5 Pole	28AWG-22AWG
Cable Acceptance:	3.0 - 3.5 mm Dia
Terminations:	
3 Pole	Single wire / PCB / Cable Screw / Solder
4 Pole	Single wire / PCB / Cable Screw / Solder
5 Pole	Single wire / PCB / Cable Screw / Solder
Mechanical Operation:	500 mating cycles
Diameter over coupling ring:	12.5mm

**Materials:**

**Panel Mount:**

Body:	Nickel Plated Brass
Coupling Nut:	Nickel Plated Brass
Colour:	Grey
Pin Contacts:	Brass, Gold plating
Socket Contacts:	Phosphor Bronze, Gold plating
O Rings & Gaskets:	Viton
RoHS:	Compliant

**Cable Connectors:**

TPU / PVC
Nickel Plated Brass
Black
Brass, Gold plating
Phosphor Bronze, Gold plating
Viton
Compliant

**Flex & Inline Connectors:**

Nickel Plated Brass / PA66
Nickel Plated Brass
Black or Grey
Brass, Gold plating
Phosphor Bronze, Gold plating
Viton
Compliant

<b>MX</b>	<b>XXX</b>	<b>XX</b>	<b>XX</b>	<b>X</b>	<b>XX</b>	<b>X</b>	<b>XX</b>
-----------	------------	-----------	-----------	----------	-----------	----------	-----------

Series	Material	Series Size	Body Style	Orientation	NO. Contacts	Code	Termination
PXM	BNI = Brass Nickel PAM = Polyamide	08	FB = Flex Body	M	03	A	ST = Screw Terminal
PXP	TPU = overmold for PUR PVC = overmold for PVC		FI = Flex Inline Body FP = Front Panel Mounting RP = Rear Panel Mounting RA = Right Angle	F	04 05	B	PC = PCB FL = Flying Lead CL = Cable SC = Solder

<b>XXX</b>	<b>XXX</b>
------------	------------

Lead Length	Cable Material
001	PUR
002	PVC
003	
010	
020	
030	
050	
100	
150	

With a high degree of mechanical and electrical stability, **Bulgin's M12 connectors** provide a **cost effective** and **flexible connectivity solution** for onsite installations, helping to **decrease downtime** in process control, manufacturing automation and industrial instrumentation applications.



## Key features:

- Reliable industry standard screw locking mechanism
- IP67 degree of protection
- A, B and D Coded versions
- Field installable, cable and panel mount options
- Plastic and metal options variants
- Straight and right angled forms
- Overmolded PVC or PUR cable connectors
- Shielded options
- Pole variants from 3 – 12



M12 connectors are established as one of the most reliable and efficient connection standards for Industrial Machinery and Factory Automation applications. With a small footprint, extremely low failure rate and high performance capabilities, this range is ideal not only for sensor connections but also for a variety of fieldbus systems.

These M12 Series circular connectors are rugged, easy to use and extremely reliable solutions for sensor/actuator connectivity in industrial automation and control applications. With an IP67 rating, they are also extremely effective in harsh environments outside of industrial automation applications where compact and dependable connections with environmental protection are required.

Bulgin's field attachable M12 connectors feature a robust aluminium coupling nut, making them a lightweight and durable alternative to the more common nickel-plated M12 nut variants and an ideal plug and play solution for upgrading sensor systems with M12 connectivity.



Bulgin's M12 Series connectors are available in a variety of industry standard keying/coding options to further minimize wiring errors and serve a large variety of customer needs.

## M12 Series coding options:

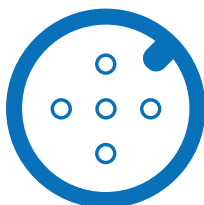

### A-Coding

Primarily for general sensor-actuator connections

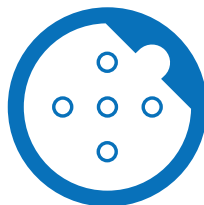

### B-Coding

For fieldbus and signal connections (PROFIBUS & INTERBUS systems)

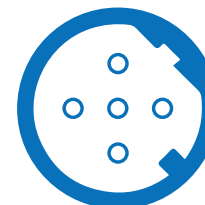

### D-Coding

For industrial Ethernets and PROFINET

M12 Rear Panel Mounting Male



PXMBNI12RPM

- 3, 4, 5, 8 and 12 poles
- PCB termination
- Different panel mounting options available
- Mates with Flex Body connectors

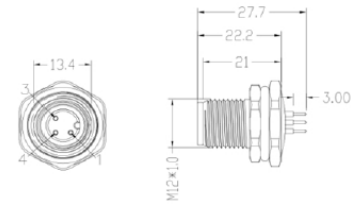

Part Number	Poles	Code	Termination	Mounting Nut
PXMBNI12RPM03APCPG9	03	A	PCB Terminal	PG9 Mounting / Gland Nut Thread
PXMBNI12RPM04APCPG9	04	A	PCB Terminal	PG9 Mounting / Gland Nut Thread
PXMBNI12RPM05APCPG9	05	A	PCB Terminal	PG9 Mounting / Gland Nut Thread
PXMBNI12RPM08APCPG9	08	A	PCB Terminal	PG9 Mounting / Gland Nut Thread
PXMBNI12RPM12APCPG9	12	A	PCB Terminal	PG9 Mounting / Gland Nut Thread
PXMBNI12RPM05BPCPG9	05	B	PCB Terminal	PG9 Mounting / Gland Nut Thread
PXMBNI12RPM04DPCPG9	04	D	PCB Terminal	PG9 Mounting / Gland Nut Thread
PXMBNI12RPM03APCM16	03	A	PCB Terminal	M16 Mounting / Gland Nut Thread
PXMBNI12RPM04APCM16	04	A	PCB Terminal	M16 Mounting / Gland Nut Thread
PXMBNI12RPM05APCM16	05	A	PCB Terminal	M16 Mounting / Gland Nut Thread
PXMBNI12RPM08APCM16	08	A	PCB Terminal	M16 Mounting / Gland Nut Thread
PXMBNI12RPM12APCM16	12	A	PCB Terminal	M16 Mounting / Gland Nut Thread
PXMBNI12RPM05BPCM16	05	B	PCB Terminal	M16 Mounting / Gland Nut Thread
PXMBNI12RPM04DPCM16	04	D	PCB Terminal	M16 Mounting / Gland Nut Thread
PXMBNI12RPM03APCM12	03	A	PCB Terminal	M12 Mounting / Gland Nut Thread
PXMBNI12RPM04APCM12	04	A	PCB Terminal	M12 Mounting / Gland Nut Thread
PXMBNI12RPM05APCM12	05	A	PCB Terminal	M12 Mounting / Gland Nut Thread
PXMBNI12RPM08APCM12	08	A	PCB Terminal	M12 Mounting / Gland Nut Thread
PXMBNI12RPM12APCM12	12	A	PCB Terminal	M12 Mounting / Gland Nut Thread
PXMBNI12RPM05BPCM12	05	B	PCB Terminal	M12 Mounting / Gland Nut Thread
PXMBNI12RPM04DPCM12	04	D	PCB Terminal	M12 Mounting / Gland Nut Thread

M12 Rear Panel Mounting Female



PXMBNI12RPF

- 3, 4, 5, 8 and 12 poles
- PCB termination
- Different panel mounting options available
- Mates with Flex Inline Body connectors

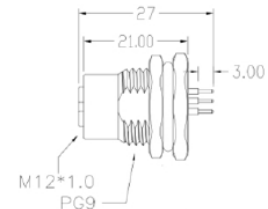

Part Number	Poles	Code	Termination	Mounting Nut
PXMBNI12RPF03APCPG9	03	A	PCB Terminal	PG9 Mounting / Gland Nut Thread
PXMBNI12RPF04APCPG9	04	A	PCB Terminal	PG9 Mounting / Gland Nut Thread
PXMBNI12RPF05APCPG9	05	A	PCB Terminal	PG9 Mounting / Gland Nut Thread
PXMBNI12RPF08APCPG9	08	A	PCB Terminal	PG9 Mounting / Gland Nut Thread
PXMBNI12RPF12APCPG9	12	A	PCB Terminal	PG9 Mounting / Gland Nut Thread
PXMBNI12RPF05BPCPG9	05	B	PCB Terminal	PG9 Mounting / Gland Nut Thread
PXMBNI12RPF04DPCPG9	04	D	PCB Terminal	PG9 Mounting / Gland Nut Thread
PXMBNI12RPF03APCM16	03	A	PCB Terminal	M16 Mounting / Gland Nut Thread
PXMBNI12RPF04APCM16	04	A	PCB Terminal	M16 Mounting / Gland Nut Thread
PXMBNI12RPF05APCM16	05	A	PCB Terminal	M16 Mounting / Gland Nut Thread
PXMBNI12RPF08APCM16	08	A	PCB Terminal	M16 Mounting / Gland Nut Thread
PXMBNI12RPF12APCM16	12	A	PCB Terminal	M16 Mounting / Gland Nut Thread
PXMBNI12RPF05BPCM16	05	B	PCB Terminal	M16 Mounting / Gland Nut Thread
PXMBNI12RPF04DPCM16	04	D	PCB Terminal	M16 Mounting / Gland Nut Thread

M12 Flex Inline Body Male



PXPPAM12FIM

- 3, 4, 5 and 8 poles
- Screw termination
- Plastic Flex Inline Body
- Mates with Flex body and panel mount connectors

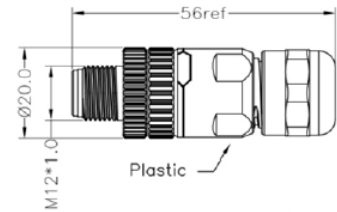

Part Number	Poles	Code	Termination
PXPPAM12FIM03ASTPG9	03	A	Screw Terminal
PXPPAM12FIM04ASTPG9	04	A	Screw Terminal
PXPPAM12FIM05ASTPG9	05	A	Screw Terminal
PXPPAM12FIM08ASTPG9	08	A	Screw Terminal

M12 Flex Body Female



PXPPAM12FBF

- 3, 4, 5 and 8 poles
- Screw termination
- Plastic Flex Body
- Mates with Flex Inline Body and panel mount connectors

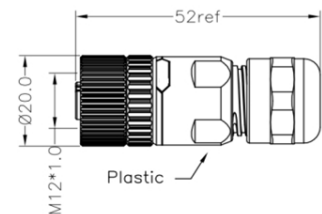

Part Number	Poles	Code	Termination
PXPPAM12FBF03ASTPG9	03	A	Screw Terminal
PXPPAM12FBF04ASTPG9	04	A	Screw Terminal
PXPPAM12FBF05ASTPG9	05	A	Screw Terminal
PXPPAM12FBF08ASTPG9	08	A	Screw Terminal

M12 Right Angled Male



PXPPAM12RAM

- 3, 4, 5 and 8 poles
- Screw termination
- Plastic Flex Inline Body
- Mates with Flex Body and panel mount connectors

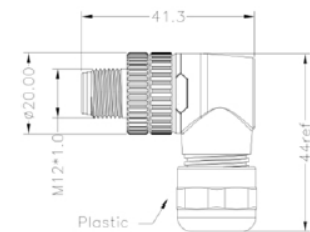

Part Number	Poles	Code	Termination
PXPPAM12RAM03ASTPG9	03	A	Screw Terminal
PXPPAM12RAM04ASTPG9	04	A	Screw Terminal
PXPPAM12RAM05ASTPG9	05	A	Screw Terminal
PXPPAM12RAM08ASTPG9	08	A	Screw Terminal

M12 Right Angled Female



PXPPAM12RAF

- 3, 4, 5 and 8 poles
- Screw termination
- Plastic Flex Body
- Mates with Flex Inline Body and panel mount connectors

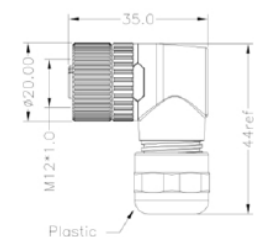

Part Number	Poles	Code	Termination
PXPPAM12RAF03ASTPG9	03	A	Screw Terminal
PXPPAM12RAF04ASTPG9	04	A	Screw Terminal
PXPPAM12RAF05ASTPG9	05	A	Screw Terminal
PXPPAM12RAF08ASTPG9	08	A	Screw Terminal

Nickel Plating M12 Flex Inline Body Male



PXMBNI12FIM

- 3, 4, 5, 8 and 12 poles
- Solder termination
- Metal Flex Inline Body
- Mates with Flex body and panel mount connectors

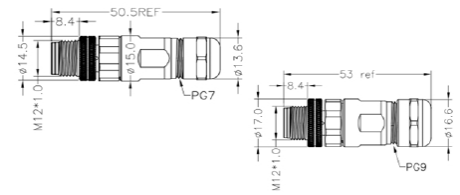

Part Number	Poles	Code	Termination	Mounting Nut
PXMBNI12FIM03ASCPG7	03	A	Solder Terminal	PG7 Mounting / Gland Nut Thread
PXMBNI12FIM04ASCPG7	04	A	Solder Terminal	PG7 Mounting / Gland Nut Thread
PXMBNI12FIM05ASCPG7	05	A	Solder Terminal	PG7 Mounting / Gland Nut Thread
PXMBNI12FIM08ASCPG7	08	A	Solder Terminal	PG7 Mounting / Gland Nut Thread
PXMBNI12FIM12ASCPG7	12	A	Solder Terminal	PG7 Mounting / Gland Nut Thread
PXMBNI12FIM05BSCPG7	05	B	Solder Terminal	PG7 Mounting / Gland Nut Thread
PXMBNI12FIM04DSCPG7	04	D	Solder Terminal	PG7 Mounting / Gland Nut Thread
PXMBNI12FIM03ASCPG9	03	A	Solder Terminal	PG9 Mounting / Gland Nut Thread
PXMBNI12FIM04ASCPG9	04	A	Solder Terminal	PG9 Mounting / Gland Nut Thread
PXMBNI12FIM05ASCPG9	05	A	Solder Terminal	PG9 Mounting / Gland Nut Thread
PXMBNI12FIM08ASCPG9	08	A	Solder Terminal	PG9 Mounting / Gland Nut Thread
PXMBNI12FIM12ASCPG9	12	A	Solder Terminal	PG9 Mounting / Gland Nut Thread
PXMBNI12FIM05BSCPG9	05	B	Solder Terminal	PG9 Mounting / Gland Nut Thread
PXMBNI12FIM04DSCPG9	04	D	Solder Terminal	PG9 Mounting / Gland Nut Thread

Nickel Plating M12 Flex Body Female



PXMBNI12FBF

- 3, 4, 5, 8 and 12 poles
- Solder termination
- Metal Flex Body
- Mates with Flex Inline Body and panel mount connectors

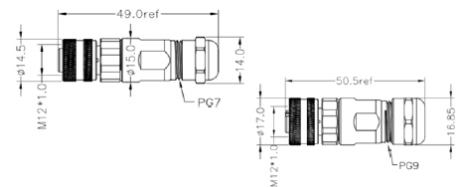

Part Number	Poles	Code	Termination	Mounting Nut
PXMBNI12FBF03ASCPG7	03	A	Solder Terminal	PG7 Mounting / Gland Nut Thread
PXMBNI12FBF04ASCPG7	04	A	Solder Terminal	PG7 Mounting / Gland Nut Thread
PXMBNI12FBF05ASCPG7	05	A	Solder Terminal	PG7 Mounting / Gland Nut Thread
PXMBNI12FBF08ASCPG7	08	A	Solder Terminal	PG7 Mounting / Gland Nut Thread
PXMBNI12FBF12ASCPG7	12	A	Solder Terminal	PG7 Mounting / Gland Nut Thread
PXMBNI12FBF05BSCPG7	05	B	Solder Terminal	PG7 Mounting / Gland Nut Thread
PXMBNI12FBF04DSCPG7	04	D	Solder Terminal	PG7 Mounting / Gland Nut Thread
PXMBNI12FBF03ASCPG9	03	A	Solder Terminal	PG9 Mounting / Gland Nut Thread
PXMBNI12FBF04ASCPG9	04	A	Solder Terminal	PG9 Mounting / Gland Nut Thread
PXMBNI12FBF05ASCPG9	05	A	Solder Terminal	PG9 Mounting / Gland Nut Thread
PXMBNI12FBF08ASCPG9	08	A	Solder Terminal	PG9 Mounting / Gland Nut Thread
PXMBNI12FBF12ASCPG9	12	A	Solder Terminal	PG9 Mounting / Gland Nut Thread
PXMBNI12FBF05BSCPG9	05	B	Solder Terminal	PG9 Mounting / Gland Nut Thread
PXMBNI12FBF04DSCPG9	04	D	Solder Terminal	PG9 Mounting / Gland Nut Thread

M12 Right Angled Female



PXPTPU12RAF  
PXPPVC12RAF

- 3, 4, 5, 8 and 12 poles
- 1,2,3,5,10 & 15M cable options
- Overmold Flex Body
- Mates with Flex Inline Body & panel mount connectors

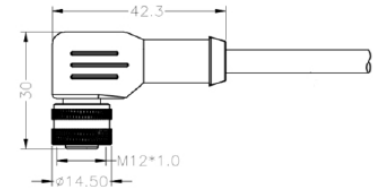

Part Number	Poles	Code	Termination	Lead Length	Cable Material
PXPPVC12RAF03ACL010PVC	03	A	Overmold Cable	1m	PVC
PXPTPU12RAF03ACL010PUR	03	A	Overmold Cable	1m	PUR
PXPPVC12RAF03ACL020PVC	03	A	Overmold Cable	2m	PVC
PXPTPU12RAF03ACL020PUR	03	A	Overmold Cable	2m	PUR
PXPPVC12RAF03ACL030PVC	03	A	Overmold Cable	3m	PVC
PXPTPU12RAF03ACL030PUR	03	A	Overmold Cable	3m	PUR
PXPPVC12RAF03ACL050PVC	03	A	Overmold Cable	5m	PVC
PXPTPU12RAF03ACL050PUR	03	A	Overmold Cable	5m	PUR
PXPPVC12RAF03ACL100PVC	03	A	Overmold Cable	10m	PVC
PXPTPU12RAF03ACL100PUR	03	A	Overmold Cable	10m	PUR
PXPPVC12RAF03ACL150PVC	03	A	Overmold Cable	15m	PVC
PXPTPU12RAF03ACL150PUR	03	A	Overmold Cable	15m	PUR
PXPPVC12RAF04ACL010PVC	04	A	Overmold Cable	1m	PVC
PXPTPU12RAF04ACL010PUR	04	A	Overmold Cable	1m	PUR
PXPPVC12RAF04ACL020PVC	04	A	Overmold Cable	2m	PVC
PXPTPU12RAF04ACL020PUR	04	A	Overmold Cable	2m	PUR
PXPPVC12RAF04ACL030PVC	04	A	Overmold Cable	3m	PVC
PXPTPU12RAF04ACL030PUR	04	A	Overmold Cable	3m	PUR
PXPPVC12RAF04ACL050PVC	04	A	Overmold Cable	5m	PVC
PXPTPU12RAF04ACL050PUR	04	A	Overmold Cable	5m	PUR
PXPPVC12RAF04ACL100PVC	04	A	Overmold Cable	10m	PVC
PXPTPU12RAF04ACL100PUR	04	A	Overmold Cable	10m	PUR
PXPPVC12RAF04ACL150PVC	04	A	Overmold Cable	15m	PVC
PXPTPU12RAF04ACL150PUR	04	A	Overmold Cable	15m	PUR
PXPPVC12RAF05ACL010PVC	05	A	Overmold Cable	1m	PVC
PXPTPU12RAF05ACL010PUR	05	A	Overmold Cable	1m	PUR
PXPPVC12RAF05ACL020PVC	05	A	Overmold Cable	2m	PVC
PXPTPU12RAF05ACL020PUR	05	A	Overmold Cable	2m	PUR
PXPPVC12RAF05ACL030PVC	05	A	Overmold Cable	3m	PVC
PXPTPU12RAF05ACL030PUR	05	A	Overmold Cable	3m	PUR
PXPPVC12RAF05ACL050PVC	05	A	Overmold Cable	5m	PVC
PXPTPU12RAF05ACL050PUR	05	A	Overmold Cable	5m	PUR
PXPPVC12RAF05ACL100PVC	05	A	Overmold Cable	10m	PVC
PXPTPU12RAF05ACL100PUR	05	A	Overmold Cable	10m	PUR
PXPPVC12RAF05ACL150PVC	05	A	Overmold Cable	15m	PVC
PXPTPU12RAF05ACL150PUR	05	A	Overmold Cable	15m	PUR
PXPPVC12RAF08ACL010PVC	08	A	Overmold Cable	1m	PVC
PXPTPU12RAF08ACL010PUR	08	A	Overmold Cable	1m	PUR
PXPPVC12RAF08ACL020PVC	08	A	Overmold Cable	2m	PVC
PXPTPU12RAF08ACL020PUR	08	A	Overmold Cable	2m	PUR
PXPPVC12RAF08ACL030PVC	08	A	Overmold Cable	3m	PVC
PXPTPU12RAF08ACL030PUR	08	A	Overmold Cable	3m	PUR
PXPPVC12RAF08ACL050PVC	08	A	Overmold Cable	5m	PVC
PXPTPU12RAF08ACL050PUR	08	A	Overmold Cable	5m	PUR
PXPPVC12RAF08ACL100PVC	08	A	Overmold Cable	10m	PVC
PXPTPU12RAF08ACL100PUR	08	A	Overmold Cable	10m	PUR
PXPPVC12RAF08ACL150PVC	08	A	Overmold Cable	15m	PVC
PXPTPU12RAF08ACL150PUR	08	A	Overmold Cable	15m	PUR
PXPPVC12RAF12ACL010PVC	12	A	Overmold Cable	1m	PVC
PXPTPU12RAF12ACL010PUR	12	A	Overmold Cable	1m	PUR
PXPPVC12RAF12ACL020PVC	12	A	Overmold Cable	2m	PVC
PXPTPU12RAF12ACL020PUR	12	A	Overmold Cable	2m	PUR
PXPPVC12RAF12ACL030PVC	12	A	Overmold Cable	3m	PVC
PXPTPU12RAF12ACL030PUR	12	A	Overmold Cable	3m	PUR
PXPPVC12RAF12ACL050PVC	12	A	Overmold Cable	5m	PVC
PXPTPU12RAF12ACL050PUR	12	A	Overmold Cable	5m	PUR
PXPPVC12RAF12ACL100PVC	12	A	Overmold Cable	10m	PVC
PXPTPU12RAF12ACL100PUR	12	A	Overmold Cable	10m	PUR
PXPPVC12RAF12ACL150PVC	12	A	Overmold Cable	15m	PVC
PXPTPU12RAF12ACL150PUR	12	A	Overmold Cable	15m	PUR

PXPPVC12RAF05BCL010PVC	05	B	Overmold Cable	1m	PVC
PXPTPU12RAF05BCL010PUR	05	B	Overmold Cable	1m	PUR
PXPPVC12RAF05BCL020PVC	05	B	Overmold Cable	2m	PVC
PXPTPU12RAF05BCL020PUR	05	B	Overmold Cable	2m	PUR
PXPPVC12RAF05BCL030PVC	05	B	Overmold Cable	3m	PVC
PXPTPU12RAF05BCL030PUR	05	B	Overmold Cable	3m	PUR
PXPPVC12RAF05BCL050PVC	05	B	Overmold Cable	5m	PVC
PXPTPU12RAF05BCL050PUR	05	B	Overmold Cable	5m	PUR
PXPPVC12RAF05BCL100PVC	05	B	Overmold Cable	10m	PVC
PXPTPU12RAF05BCL100PUR	05	B	Overmold Cable	10m	PUR
PXPPVC12RAF05BCL150PVC	05	B	Overmold Cable	15m	PVC
PXPTPU12RAF05BCL150PUR	05	B	Overmold Cable	15m	PUR
PXPPVC12RAF04DCL010PVC	04	D	Overmold Cable	1m	PVC
PXPTPU12RAF04DCL010PUR	04	D	Overmold Cable	1m	PUR
PXPPVC12RAF04DCL020PVC	04	D	Overmold Cable	2m	PVC
PXPTPU12RAF04DCL020PUR	04	D	Overmold Cable	2m	PUR
PXPPVC12RAF04DCL030PVC	04	D	Overmold Cable	3m	PVC
PXPTPU12RAF04DCL030PUR	04	D	Overmold Cable	3m	PUR
PXPPVC12RAF04DCL050PVC	04	D	Overmold Cable	5m	PVC
PXPTPU12RAF04DCL050PUR	04	D	Overmold Cable	5m	PUR
PXPPVC12RAF04DCL100PVC	04	D	Overmold Cable	10m	PVC
PXPTPU12RAF04DCL100PUR	04	D	Overmold Cable	10m	PUR
PXPPVC12RAF04DCL150PVC	04	D	Overmold Cable	15m	PVC
PXPTPU12RAF04DCL150PUR	04	D	Overmold Cable	15m	PUR

M12 Flex Body Female



PXPTPU12FBF  
PXPPVC12FBF

- 3, 4, 5, 8 and 12 poles
- 1,2,3,5,10 & 15M cable options
- Overmold Flex Body
- Mates with Flex Inline Body & panel mount connectors

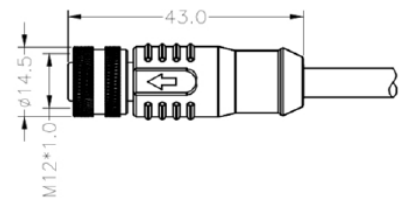

Part Number	Poles	Code	Termination	Lead Length	Cable Material
PXPPVC12FBF03ACL010PVC	03	A	Overmold Cable	1m	PVC
PXPTPU12FBF03ACL010PUR	03	A	Overmold Cable	1m	PUR
PXPPVC12FBF03ACL020PVC	03	A	Overmold Cable	2m	PVC
PXPTPU12FBF03ACL020PUR	03	A	Overmold Cable	2m	PUR
PXPPVC12FBF03ACL030PVC	03	A	Overmold Cable	3m	PVC
PXPTPU12FBF03ACL030PUR	03	A	Overmold Cable	3m	PUR
PXPPVC12FBF03ACL050PVC	03	A	Overmold Cable	5m	PVC
PXPTPU12FBF03ACL050PUR	03	A	Overmold Cable	5m	PUR
PXPPVC12FBF03ACL100PVC	03	A	Overmold Cable	10m	PVC
PXPTPU12FBF03ACL100PUR	03	A	Overmold Cable	10m	PUR
PXPPVC12FBF03ACL150PVC	03	A	Overmold Cable	15m	PVC
PXPTPU12FBF03ACL150PUR	03	A	Overmold Cable	15m	PUR
PXPPVC12FBF04ACL010PVC	04	A	Overmold Cable	1m	PVC
PXPTPU12FBF04ACL010PUR	04	A	Overmold Cable	1m	PUR
PXPPVC12FBF04ACL020PVC	04	A	Overmold Cable	2m	PVC
PXPTPU12FBF04ACL020PUR	04	A	Overmold Cable	2m	PUR
PXPPVC12FBF04ACL030PVC	04	A	Overmold Cable	3m	PVC
PXPTPU12FBF04ACL030PUR	04	A	Overmold Cable	3m	PUR
PXPPVC12FBF04ACL050PVC	04	A	Overmold Cable	5m	PVC
PXPTPU12FBF04ACL050PUR	04	A	Overmold Cable	5m	PUR
PXPPVC12FBF04ACL100PVC	04	A	Overmold Cable	10m	PVC
PXPTPU12FBF04ACL100PUR	04	A	Overmold Cable	10m	PUR
PXPPVC12FBF04ACL150PVC	04	A	Overmold Cable	15m	PVC
PXPTPU12FBF04ACL150PUR	04	A	Overmold Cable	15m	PUR
PXPPVC12FBF05ACL010PVC	05	A	Overmold Cable	1m	PVC
PXPTPU12FBF05ACL010PUR	05	A	Overmold Cable	1m	PUR
PXPPVC12FBF05ACL020PVC	05	A	Overmold Cable	2m	PVC
PXPTPU12FBF05ACL020PUR	05	A	Overmold Cable	2m	PUR
PXPPVC12FBF05ACL030PVC	05	A	Overmold Cable	3m	PVC
PXPTPU12FBF05ACL030PUR	05	A	Overmold Cable	3m	PUR
PXPPVC12FBF05ACL050PVC	05	A	Overmold Cable	5m	PVC
PXPTPU12FBF05ACL050PUR	05	A	Overmold Cable	5m	PUR
PXPPVC12FBF05ACL100PVC	05	A	Overmold Cable	10m	PVC
PXPTPU12FBF05ACL100PUR	05	A	Overmold Cable	10m	PUR
PXPPVC12FBF05ACL150PVC	05	A	Overmold Cable	15m	PVC
PXPTPU12FBF05ACL150PUR	05	A	Overmold Cable	15m	PUR

PXPPVC12FBF08ACL010PVC	08	A	Overmold Cable	1m	PVC
PXPTPU12FBF08ACL010PUR	08	A	Overmold Cable	1m	PUR
PXPPVC12FBF08ACL020PVC	08	A	Overmold Cable	2m	PVC
PXPTPU12FBF08ACL020PUR	08	A	Overmold Cable	2m	PUR
PXPPVC12FBF08ACL030PVC	08	A	Overmold Cable	3m	PVC
PXPTPU12FBF08ACL030PUR	08	A	Overmold Cable	3m	PUR
PXPPVC12FBF08ACL050PVC	08	A	Overmold Cable	5m	PVC
PXPTPU12FBF08ACL050PUR	08	A	Overmold Cable	5m	PUR
PXPPVC12FBF08ACL100PVC	08	A	Overmold Cable	10m	PVC
PXPTPU12FBF08ACL100PUR	08	A	Overmold Cable	10m	PUR
PXPPVC12FBF08ACL150PVC	08	A	Overmold Cable	15m	PVC
PXPTPU12FBF08ACL150PUR	08	A	Overmold Cable	15m	PUR
PXPPVC12FBF12ACL010PVC	12	A	Overmold Cable	1m	PVC
PXPTPU12FBF12ACL010PUR	12	A	Overmold Cable	1m	PUR
PXPPVC12FBF12ACL020PVC	12	A	Overmold Cable	2m	PVC
PXPTPU12FBF12ACL020PUR	12	A	Overmold Cable	2m	PUR
PXPPVC12FBF12ACL030PVC	12	A	Overmold Cable	3m	PVC
PXPTPU12FBF12ACL030PUR	12	A	Overmold Cable	3m	PUR
PXPPVC12FBF12ACL050PVC	12	A	Overmold Cable	5m	PVC
PXPTPU12FBF12ACL050PUR	12	A	Overmold Cable	5m	PUR
PXPPVC12FBF12ACL100PVC	12	A	Overmold Cable	10m	PVC
PXPTPU12FBF12ACL100PUR	12	A	Overmold Cable	10m	PUR
PXPPVC12FBF12ACL150PVC	12	A	Overmold Cable	15m	PVC
PXPTPU12FBF12ACL150PUR	12	A	Overmold Cable	15m	PUR
PXPPVC12FBF05BCL010PVC	05	B	Overmold Cable	1m	PVC
PXPTPU12FBF05BCL010PUR	05	B	Overmold Cable	1m	PUR
PXPPVC12FBF05BCL020PVC	05	B	Overmold Cable	2m	PVC
PXPTPU12FBF05BCL020PUR	05	B	Overmold Cable	2m	PUR
PXPPVC12FBF05BCL030PVC	05	B	Overmold Cable	3m	PVC
PXPTPU12FBF05BCL030PUR	05	B	Overmold Cable	3m	PUR
PXPPVC12FBF05BCL050PVC	05	B	Overmold Cable	5m	PVC
PXPTPU12FBF05BCL050PUR	05	B	Overmold Cable	5m	PUR
PXPPVC12FBF05BCL100PVC	05	B	Overmold Cable	10m	PVC
PXPTPU12FBF05BCL100PUR	05	B	Overmold Cable	10m	PUR
PXPPVC12FBF05BCL150PVC	05	B	Overmold Cable	15m	PVC
PXPTPU12FBF05BCL150PUR	05	B	Overmold Cable	15m	PUR
PXPPVC12FBF04DCL010PVC	04	D	Overmold Cable	1m	PVC
PXPTPU12FBF04DCL010PUR	04	D	Overmold Cable	1m	PUR
PXPPVC12FBF04DCL020PVC	04	D	Overmold Cable	2m	PVC
PXPTPU12FBF04DCL020PUR	04	D	Overmold Cable	2m	PUR
PXPPVC12FBF04DCL030PVC	04	D	Overmold Cable	3m	PVC
PXPTPU12FBF04DCL030PUR	04	D	Overmold Cable	3m	PUR
PXPPVC12FBF04DCL050PVC	04	D	Overmold Cable	5m	PVC
PXPTPU12FBF04DCL050PUR	04	D	Overmold Cable	5m	PUR
PXPPVC12FBF04DCL100PVC	04	D	Overmold Cable	10m	PVC
PXPTPU12FBF04DCL100PUR	04	D	Overmold Cable	10m	PUR
PXPPVC12FBF04DCL150PVC	04	D	Overmold Cable	15m	PVC
PXPTPU12FBF04DCL150PUR	04	D	Overmold Cable	15m	PUR

M12 Right Angled Male



PXPTPU12RAM  
PXPPVC12RAM

- 3, 4, 5, 8 and 12 poles
- 1,2,3,5,10 & 15M cable options
- Overmold Flex Inline Body
- Mates with Flex Body & panel mount connectors

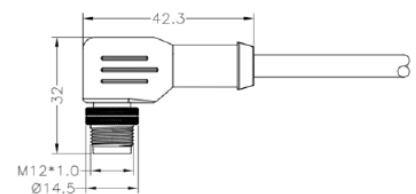

Part Number	Poles	Code	Termination	Lead Length	Cable Material
PXPPVC12RAM03ACL010PVC	03	A	Overmold Cable	1m	PVC
PXPTPU12RAM03ACL010PUR	03	A	Overmold Cable	1m	PUR
PXPPVC12RAM03ACL020PVC	03	A	Overmold Cable	2m	PVC
PXPTPU12RAM03ACL020PUR	03	A	Overmold Cable	2m	PUR
PXPPVC12RAM03ACL030PVC	03	A	Overmold Cable	3m	PVC
PXPTPU12RAM03ACL030PUR	03	A	Overmold Cable	3m	PUR
PXPPVC12RAM03ACL050PVC	03	A	Overmold Cable	5m	PVC
PXPTPU12RAM03ACL050PUR	03	A	Overmold Cable	5m	PUR
PXPPVC12RAM03ACL100PVC	03	A	Overmold Cable	10m	PVC
PXPTPU12RAM03ACL100PUR	03	A	Overmold Cable	10m	PUR
PXPPVC12RAM03ACL150PVC	03	A	Overmold Cable	15m	PVC
PXPTPU12RAM03ACL150PUR	03	A	Overmold Cable	15m	PUR

PXPPVC12RAM04ACL010PVC	04	A	Overmold Cable	1m	PVC
PXPTPU12RAM04ACL010PUR	04	A	Overmold Cable	1m	PUR
PXPPVC12RAM04ACL020PVC	04	A	Overmold Cable	2m	PVC
PXPTPU12RAM04ACL020PUR	04	A	Overmold Cable	2m	PUR
PXPPVC12RAM04ACL030PVC	04	A	Overmold Cable	3m	PVC
PXPTPU12RAM04ACL030PUR	04	A	Overmold Cable	3m	PUR
PXPPVC12RAM04ACL050PVC	04	A	Overmold Cable	5m	PVC
PXPTPU12RAM04ACL050PUR	04	A	Overmold Cable	5m	PUR
PXPPVC12RAM04ACL100PVC	04	A	Overmold Cable	10m	PVC
PXPTPU12RAM04ACL100PUR	04	A	Overmold Cable	10m	PUR
PXPPVC12RAM04ACL150PVC	04	A	Overmold Cable	15m	PVC
PXPTPU12RAM04ACL150PUR	04	A	Overmold Cable	15m	PUR
PXPPVC12RAM05ACL010PVC	05	A	Overmold Cable	1m	PVC
PXPTPU12RAM05ACL010PUR	05	A	Overmold Cable	1m	PUR
PXPPVC12RAM05ACL020PVC	05	A	Overmold Cable	2m	PVC
PXPTPU12RAM05ACL020PUR	05	A	Overmold Cable	2m	PUR
PXPPVC12RAM05ACL030PVC	05	A	Overmold Cable	3m	PVC
PXPTPU12RAM05ACL030PUR	05	A	Overmold Cable	3m	PUR
PXPPVC12RAM05ACL050PVC	05	A	Overmold Cable	5m	PVC
PXPTPU12RAM05ACL050PUR	05	A	Overmold Cable	5m	PUR
PXPPVC12RAM05ACL100PVC	05	A	Overmold Cable	10m	PVC
PXPTPU12RAM05ACL100PUR	05	A	Overmold Cable	10m	PUR
PXPPVC12RAM05ACL150PVC	05	A	Overmold Cable	15m	PVC
PXPTPU12RAM05ACL150PUR	05	A	Overmold Cable	15m	PUR
PXPPVC12RAM08ACL010PVC	08	A	Overmold Cable	1m	PVC
PXPTPU12RAM08ACL010PUR	08	A	Overmold Cable	1m	PUR
PXPPVC12RAM08ACL020PVC	08	A	Overmold Cable	2m	PVC
PXPTPU12RAM08ACL020PUR	08	A	Overmold Cable	2m	PUR
PXPPVC12RAM08ACL030PVC	08	A	Overmold Cable	3m	PVC
PXPTPU12RAM08ACL030PUR	08	A	Overmold Cable	3m	PUR
PXPPVC12RAM08ACL050PVC	08	A	Overmold Cable	5m	PVC
PXPTPU12RAM08ACL050PUR	08	A	Overmold Cable	5m	PUR
PXPPVC12RAM08ACL100PVC	08	A	Overmold Cable	10m	PVC
PXPTPU12RAM08ACL100PUR	08	A	Overmold Cable	10m	PUR
PXPPVC12RAM08ACL150PVC	08	A	Overmold Cable	15m	PVC
PXPTPU12RAM08ACL150PUR	08	A	Overmold Cable	15m	PUR
PXPPVC12RAM12ACL010PVC	12	A	Overmold Cable	1m	PVC
PXPTPU12RAM12ACL010PUR	12	A	Overmold Cable	1m	PUR
PXPPVC12RAM12ACL020PVC	12	A	Overmold Cable	2m	PVC
PXPTPU12RAM12ACL020PUR	12	A	Overmold Cable	2m	PUR
PXPPVC12RAM12ACL030PVC	12	A	Overmold Cable	3m	PVC
PXPTPU12RAM12ACL030PUR	12	A	Overmold Cable	3m	PUR
PXPPVC12RAM12ACL050PVC	12	A	Overmold Cable	5m	PVC
PXPTPU12RAM12ACL050PUR	12	A	Overmold Cable	5m	PUR
PXPPVC12RAM12ACL100PVC	12	A	Overmold Cable	10m	PVC
PXPTPU12RAM12ACL100PUR	12	A	Overmold Cable	10m	PUR
PXPPVC12RAM12ACL150PVC	12	A	Overmold Cable	15m	PVC
PXPTPU12RAM12ACL150PUR	12	A	Overmold Cable	15m	PUR
PXPPVC12RAM05BCL010PVC	05	B	Overmold Cable	1m	PVC
PXPTPU12RAM05BCL010PUR	05	B	Overmold Cable	1m	PUR
PXPPVC12RAM05BCL020PVC	05	B	Overmold Cable	2m	PVC
PXPTPU12RAM05BCL020PUR	05	B	Overmold Cable	2m	PUR
PXPPVC12RAM05BCL030PVC	05	B	Overmold Cable	3m	PVC
PXPTPU12RAM05BCL030PUR	05	B	Overmold Cable	3m	PUR
PXPPVC12RAM05BCL050PVC	05	B	Overmold Cable	5m	PVC
PXPTPU12RAM05BCL050PUR	05	B	Overmold Cable	5m	PUR
PXPPVC12RAM05BCL100PVC	05	B	Overmold Cable	10m	PVC
PXPTPU12RAM05BCL100PUR	05	B	Overmold Cable	10m	PUR
PXPPVC12RAM05BCL150PVC	05	B	Overmold Cable	15m	PVC
PXPTPU12RAM05BCL150PUR	05	B	Overmold Cable	15m	PUR
PXPPVC12RAM04DCL010PVC	04	D	Overmold Cable	1m	PVC
PXPTPU12RAM04DCL010PUR	04	D	Overmold Cable	1m	PUR
PXPPVC12RAM04DCL020PVC	04	D	Overmold Cable	2m	PVC
PXPTPU12RAM04DCL020PUR	04	D	Overmold Cable	2m	PUR
PXPPVC12RAM04DCL030PVC	04	D	Overmold Cable	3m	PVC
PXPTPU12RAM04DCL030PUR	04	D	Overmold Cable	3m	PUR
PXPPVC12RAM04DCL050PVC	04	D	Overmold Cable	5m	PVC
PXPTPU12RAM04DCL050PUR	04	D	Overmold Cable	5m	PUR
PXPPVC12RAM04DCL100PVC	04	D	Overmold Cable	10m	PVC
PXPTPU12RAM04DCL100PUR	04	D	Overmold Cable	10m	PUR
PXPPVC12RAM04DCL150PVC	04	D	Overmold Cable	15m	PVC
PXPTPU12RAM04DCL150PUR	04	D	Overmold Cable	15m	PUR



M12 Flex Inline Body Male



PXPTPU12FIM  
PXPPVC12FIM

- ⊖ 3, 4, 5, 8 and 12 poles
- ⊖ 1,2,3,5,10 & 15M cable options
- ⊖ Overmold Flex Inline Body
- ⊖ Mates with Flex Body & panel mount connectors

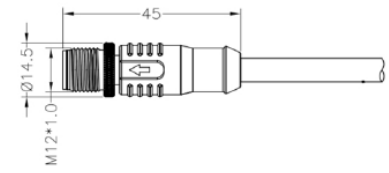

Part Number	Poles	Code	Termination	Lead Length	Cable Material
PXPPVC12FIM03ACL010PVC	03	A	Overmold Cable	1m	PVC
PXPTPU12FIM03ACL010PUR	03	A	Overmold Cable	1m	PUR
PXPPVC12FIM03ACL020PVC	03	A	Overmold Cable	2m	PVC
PXPTPU12FIM03ACL020PUR	03	A	Overmold Cable	2m	PUR
PXPPVC12FIM03ACL030PVC	03	A	Overmold Cable	3m	PVC
PXPTPU12FIM03ACL030PUR	03	A	Overmold Cable	3m	PUR
PXPPVC12FIM03ACL050PVC	03	A	Overmold Cable	5m	PVC
PXPTPU12FIM03ACL050PUR	03	A	Overmold Cable	5m	PUR
PXPPVC12FIM03ACL100PVC	03	A	Overmold Cable	10m	PVC
PXPTPU12FIM03ACL100PUR	03	A	Overmold Cable	10m	PUR
PXPPVC12FIM03ACL150PVC	03	A	Overmold Cable	15m	PVC
PXPTPU12FIM03ACL150PUR	03	A	Overmold Cable	15m	PUR
PXPPVC12FIM04ACL010PVC	04	A	Overmold Cable	1m	PVC
PXPTPU12FIM04ACL010PUR	04	A	Overmold Cable	1m	PUR
PXPPVC12FIM04ACL020PVC	04	A	Overmold Cable	2m	PVC
PXPTPU12FIM04ACL020PUR	04	A	Overmold Cable	2m	PUR
PXPPVC12FIM04ACL030PVC	04	A	Overmold Cable	3m	PVC
PXPTPU12FIM04ACL030PUR	04	A	Overmold Cable	3m	PUR
PXPPVC12FIM04ACL050PVC	04	A	Overmold Cable	5m	PVC
PXPTPU12FIM04ACL050PUR	04	A	Overmold Cable	5m	PUR
PXPPVC12FIM04ACL100PVC	04	A	Overmold Cable	10m	PVC
PXPTPU12FIM04ACL100PUR	04	A	Overmold Cable	10m	PUR
PXPPVC12FIM04ACL150PVC	04	A	Overmold Cable	15m	PVC
PXPTPU12FIM04ACL150PUR	04	A	Overmold Cable	15m	PUR
PXPPVC12FIM05ACL010PVC	05	A	Overmold Cable	1m	PVC
PXPTPU12FIM05ACL010PUR	05	A	Overmold Cable	1m	PUR
PXPPVC12FIM05ACL020PVC	05	A	Overmold Cable	2m	PVC
PXPTPU12FIM05ACL020PUR	05	A	Overmold Cable	2m	PUR
PXPPVC12FIM05ACL030PVC	05	A	Overmold Cable	3m	PVC
PXPTPU12FIM05ACL030PUR	05	A	Overmold Cable	3m	PUR
PXPPVC12FIM05ACL050PVC	05	A	Overmold Cable	5m	PVC
PXPTPU12FIM05ACL050PUR	05	A	Overmold Cable	5m	PUR
PXPPVC12FIM05ACL100PVC	05	A	Overmold Cable	10m	PVC
PXPTPU12FIM05ACL100PUR	05	A	Overmold Cable	10m	PUR
PXPPVC12FIM05ACL150PVC	05	A	Overmold Cable	15m	PVC
PXPTPU12FIM05ACL150PUR	05	A	Overmold Cable	15m	PUR
PXPPVC12FIM08ACL010PVC	08	A	Overmold Cable	1m	PVC
PXPTPU12FIM08ACL010PUR	08	A	Overmold Cable	1m	PUR
PXPPVC12FIM08ACL020PVC	08	A	Overmold Cable	2m	PVC
PXPTPU12FIM08ACL020PUR	08	A	Overmold Cable	2m	PUR
PXPPVC12FIM08ACL030PVC	08	A	Overmold Cable	3m	PVC
PXPTPU12FIM08ACL030PUR	08	A	Overmold Cable	3m	PUR
PXPPVC12FIM08ACL050PVC	08	A	Overmold Cable	5m	PVC
PXPTPU12FIM08ACL050PUR	08	A	Overmold Cable	5m	PUR
PXPPVC12FIM08ACL100PVC	08	A	Overmold Cable	10m	PVC
PXPTPU12FIM08ACL100PUR	08	A	Overmold Cable	10m	PUR
PXPPVC12FIM08ACL150PVC	08	A	Overmold Cable	15m	PVC
PXPTPU12FIM08ACL150PUR	08	A	Overmold Cable	15m	PUR
PXPPVC12FIM12ACL010PVC	12	A	Overmold Cable	1m	PVC
PXPTPU12FIM12ACL010PUR	12	A	Overmold Cable	1m	PUR
PXPPVC12FIM12ACL020PVC	12	A	Overmold Cable	2m	PVC
PXPTPU12FIM12ACL020PUR	12	A	Overmold Cable	2m	PUR
PXPPVC12FIM12ACL030PVC	12	A	Overmold Cable	3m	PVC
PXPTPU12FIM12ACL030PUR	12	A	Overmold Cable	3m	PUR
PXPPVC12FIM12ACL050PVC	12	A	Overmold Cable	5m	PVC
PXPTPU12FIM12ACL050PUR	12	A	Overmold Cable	5m	PUR
PXPPVC12FIM12ACL100PVC	12	A	Overmold Cable	10m	PVC
PXPTPU12FIM12ACL100PUR	12	A	Overmold Cable	10m	PUR
PXPPVC12FIM12ACL150PVC	12	A	Overmold Cable	15m	PVC
PXPTPU12FIM12ACL150PUR	12	A	Overmold Cable	15m	PUR

PXPPVC12FIM05BCL010PVC	05	B	Overmold Cable	1m	PVC
PXPTPU12FIM05BCL010PUR	05	B	Overmold Cable	1m	PUR
PXPPVC12FIM05BCL020PVC	05	B	Overmold Cable	2m	PVC
PXPTPU12FIM05BCL020PUR	05	B	Overmold Cable	2m	PUR
PXPPVC12FIM05BCL030PVC	05	B	Overmold Cable	3m	PVC
PXPTPU12FIM05BCL030PUR	05	B	Overmold Cable	3m	PUR
PXPPVC12FIM05BCL050PVC	05	B	Overmold Cable	5m	PVC
PXPTPU12FIM05BCL050PUR	05	B	Overmold Cable	5m	PUR
PXPPVC12FIM05BCL100PVC	05	B	Overmold Cable	10m	PVC
PXPTPU12FIM05BCL100PUR	05	B	Overmold Cable	10m	PUR
PXPPVC12FIM05BCL150PVC	05	B	Overmold Cable	15m	PVC
PXPTPU12FIM05BCL150PUR	05	B	Overmold Cable	15m	PUR
PXPPVC12FIM04DCL010PVC	04	D	Overmold Cable	1m	PVC
PXPTPU12FIM04DCL010PUR	04	D	Overmold Cable	1m	PUR
PXPPVC12FIM04DCL020PVC	04	D	Overmold Cable	2m	PVC
PXPTPU12FIM04DCL020PUR	04	D	Overmold Cable	2m	PUR
PXPPVC12FIM04DCL030PVC	04	D	Overmold Cable	3m	PVC
PXPTPU12FIM04DCL030PUR	04	D	Overmold Cable	3m	PUR
PXPPVC12FIM04DCL050PVC	04	D	Overmold Cable	5m	PVC
PXPTPU12FIM04DCL050PUR	04	D	Overmold Cable	5m	PUR
PXPPVC12FIM04DCL100PVC	04	D	Overmold Cable	10m	PVC
PXPTPU12FIM04DCL100PUR	04	D	Overmold Cable	10m	PUR
PXPPVC12FIM04DCL150PVC	04	D	Overmold Cable	15m	PVC
PXPTPU12FIM04DCL150PUR	04	D	Overmold Cable	15m	PUR

PA66 M12 Sealing Cap



PXPPAM12

- Sealing caps to maintain IP rating
- Male & Female versions

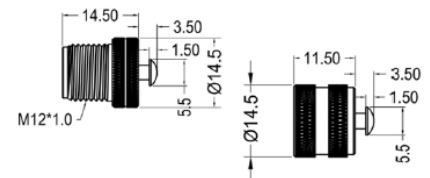

Part Number	Series	Type	Material
-------------	--------	------	----------

PXPPAM12CAM	M12	Male	PA66
PXPPAM12CAF	M12	Female	PA66

Brass - Nickel Plating M12 Sealing Cap



PXMBNI12

- Sealing caps to maintain IP rating
- Male & Female versions

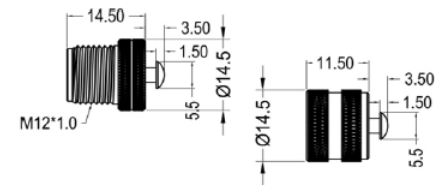

Part Number	Series	Type	Material
-------------	--------	------	----------

PXMBNI12CAM	M12	Male	Brass - Nickel Plating
PXMBNI12CAF	M12	Female	Brass - Nickel Plating

**Electrical**

No. Poles:	3	4	5	8	12
Current Rating:	4A	4A	4A	2A	1.5A
Voltage Rating (ac/dc) :	250V	250V	60V	30V	30V
Contact Resistance:	<10mΩ				
Insulation Resistance:	>100MΩ				
AC Breakdown Voltage:					
3 Pole	1.5KV				
4 Pole	1.5KV				
5 Pole	1.5KV				
8 Pole	0.8KV				
12 Pole	0.8KV				
Operating Temp Range:	-25°C to 80°C				

**Mechanical:**

Locking Mechanism:	Screw coupling
Sealing:	IP67
Contact Accomodation:	
3, 4, 5, 8 & 12 Pole	28AWG-22AWG
Cable Acceptance:	4.6 - 8.0mm Dia
Terminations:	
3, 4, 5, 8	PCB / Screw / Solder / Cable
12	PCB / Solder / Cable
Mechanical Operation:	500 mating cycles
Largest diameter over coupling ring:	20.0mm

**Materials:**

**Panel Mount:**

Body:	Nickel Plated Brass
Coupling Nut:	Nickel Plated Brass
Colour:	Grey
Pin Contacts:	Brass, Gold plating
Socket Contacts:	Phosphor Bronze, Gold plating
O Rings & Gaskets:	Viton
RoHS:	Compliant

**Cable Connectors:**

TPU / PVC
Nickel Plated Brass
Black
Brass, Gold plating
Phosphor Bronze, Gold plating
Viton
Compliant

**Flex & Inline Connectors:**

Nickel Plated Brass / PA66
Nickel Plated Brass
Black or Grey
Brass, Gold plating
Phosphor Bronze, Gold plating
Viton
Compliant

<b>MX</b>	<b>XXX</b>	<b>XX</b>	<b>XX</b>	<b>X</b>	<b>XX</b>	<b>X</b>	<b>XX</b>
-----------	------------	-----------	-----------	----------	-----------	----------	-----------

Series	Material	Series Size	Body Style	Orientation	NO. Contacts	Code	Termination
PXM	BNI = Brass Nickel PAM = Polyamide	12	FB = Flex Body	M	03	A	ST = Screw Terminal
PXP	TPU = overmold for PUR PVC = overmold for PVC		FI = Flex Inline Body RP = Rear Panel Mounting RA = Right Angle SC = Sealing Cap	F	04 05 08 12	B D	PC = PCB CL = Cable SC = Solder

<b>XXX</b>	<b>XXX</b>	<b>XXX</b>
------------	------------	------------

Mounting / Gland Nut Thread	Lead Length	Cable Material
PG9	001	PUR
PG7	002	PVC
M16	003	
M12	010	
	020	
	030	
	050	
	100	
	150	

With a rugged metal housing and environmental protection rating of IP67 when mated, Bulgin's robust M16 circular DIN connector range is an ideal solution for ensuring that power and signal connections are not compromised in harsh environments and industrial applications.



## Key features:

- Screw locking compliant with DIN EN 61076-2-106
- IP67 degree of protection
- Robust metal connector
- Excellent EMI shielding
- Pole variants from 3 - 12

M16 Flex Inline Body Male



PXMBNI16FIM

- 3, 4, 5, 6, 8 and 12 poles
- Solder termination
- Metal Flex Inline Body
- Mates with Flex Body and panel mount connectors

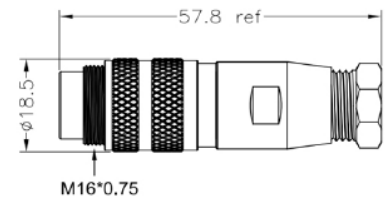

Part Number	Poles	Code	Termination
PXMBNI16FIM03ASC	03	A	Solder Terminal
PXMBNI16FIM04ASC	04	A	Solder Terminal
PXMBNI16FIM05ASC	05	A	Solder Terminal
PXMBNI16FIM06ASC	06	A	Solder Terminal
PXMBNI16FIM08ASC	08	A	Solder Terminal
PXMBNI16FIM12ASC	12	A	Solder Terminal

M16 Flex Body Female



PXMBNI16FBF

- 3, 4, 5, 6, 8 and 12 poles
- Solder termination
- Metal Flex Body
- Mates with Flex Inline Body and panel mount connectors

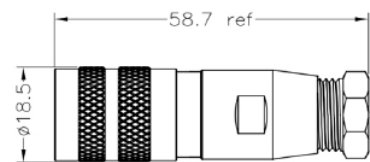

Part Number	Poles	Code	Termination
PXMBNI16FBF03ASC	03	A	Solder Terminal
PXMBNI16FBF04ASC	04	A	Solder Terminal
PXMBNI16FBF05ASC	05	A	Solder Terminal
PXMBNI16FBF06ASC	06	A	Solder Terminal
PXMBNI16FBF08ASC	08	A	Solder Terminal
PXMBNI16FBF12ASC	12	A	Solder Terminal

M16 Rear Panel Mounting Male



PXMBNI16RPM

- 3, 4, 5, 6, 8 and 12 poles
- Solder termination
- Rear panel mount M16
- Mates with Flex body connectors

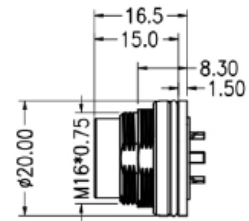

Part Number	Poles	Code	Termination
PXMBNI16RPM03ASC	03	A	Solder Terminal
PXMBNI16RPM04ASC	04	A	Solder Terminal
PXMBNI16RPM05ASC	05	A	Solder Terminal
PXMBNI16RPM06ASC	06	A	Solder Terminal
PXMBNI16RPM08ASC	08	A	Solder Terminal
PXMBNI16RPM12ASC	12	A	Solder Terminal

M16 Rear Panel Mounting Female



PXMBNI16RPF

- 3, 4, 5, 6, 8 and 12 poles
- Solder termination
- Rear panel mount M16
- Mates with Flex Inline Body connectors

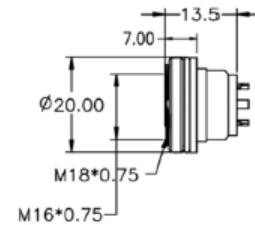

Part Number	Poles	Code	Termination
PXMBNI16RPF03ASC	03	A	Solder Terminal
PXMBNI16RPF04ASC	04	A	Solder Terminal
PXMBNI16RPF05ASC	05	A	Solder Terminal
PXMBNI16RPF06ASC	06	A	Solder Terminal
PXMBNI16RPF08ASC	08	A	Solder Terminal
PXMBNI16RPF12ASC	12	A	Solder Terminal

**Electrical**

No. Poles:	3	4	5	6	8	12
Current Rating:	7A	7A	6A	5A	5A	3A
Voltage Rating (ac/dc) :	250V	250V	250V	125V	60V	60V
Contact Resistance:	<5mΩ	3, 4, 5, 6 and 8 Pole				
	<3mΩ	12 Pole				
Insulation Resistance:	>100 <sup>3</sup> MΩ					
AC Breakdown Voltage:						
3 Pole	2.0KV					
4 Pole	2.0KV					
5 Pole	2.0KV					
6 Pole	1.5KV					
8 Pole	1.5KV					
12 Pole	1.5KV					
Operating Temp Range:	-25°C to 80°C					

**Mechanical:**

Locking Mechanism:	Screw coupling
Sealing:	IP67
Contact Accomodation:	
3, 4, 5, 6 and 8 Pole	20AWG
12 Pole	24 AWG
Cable Acceptance:	5.0 - 7.5mm Dia
Terminations:	Solder
Mechanical Operation:	500 mating cycles
Diameter over coupling ring:	18.5mm

**Materials:**

Body:	Nickel Plated Brass
Coupling Nut:	Nickel Plated Brass
Colour:	Grey
Pin Contacts:	Brass, Gold plating
Socket Contacts:	Phosphor Bronze, Gold plating
O Rings & Gaskets:	Viton
RoHS:	Compliant

**Panel Mount:**

Body:	Nickel Plated Brass
Coupling Nut:	Nickel Plated Brass
Colour:	Grey
Pin Contacts:	Brass, Gold plating
Socket Contacts:	Phosphor Bronze, Gold plating
O Rings & Gaskets:	Viton
RoHS:	Compliant

**Flex & Inline Connectors:**

Body:	Nickel Plated Brass
Coupling Nut:	Nickel Plated Brass
Colour:	Grey
Pin Contacts:	Brass, Gold plating
Socket Contacts:	Phosphor Bronze, Gold plating
O Rings & Gaskets:	Viton
RoHS:	Compliant

<b>MX</b>	<b>XXX</b>	<b>XX</b>	<b>XX</b>	<b>X</b>	<b>XX</b>	<b>X</b>	<b>XX</b>
<b>Series</b>	<b>Material</b>	<b>Series Size</b>	<b>Body Style</b>	<b>Orientation</b>	<b>NO. Contacts</b>	<b>Code</b>	<b>Termination</b>
PXM	BNI = Brass Nickel	16	FB = Flex Body	M	03	A	SC = Solder
			FI = Flex Inline Body	F	04		
			RP = Rear Panel Mounting		05		
					06		
					08		
					12		

Typically used for providing **high performance, reliable and robust connections** in commercial and industrial automation applications, these **IP67 rated signal and power connectors** offer a **high degree of protection** against environmental factors such as water, dirt and moisture.

Bulgin's range of M23 Connectors includes field installable male and female connectors as well as front panel mount options from 12- to 19-pole in straight and right angled versions.



## Key features:

- A-Coded
- Male and female variants, 12 or 19 poles
- Straight and angled configurations
- Robust metal housing
- IP67 protection rating (when mated)
- Voltages up to 250 V and currents up to 8 A



M23 Flex Inline Body



PXMBNI23FIM

- Available in 12 and 19 poles
- Solder termination
- Metal Flex Inline Body
- Mates with panel mount connectors

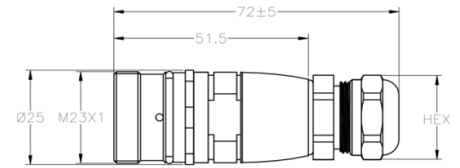

Part Number	Poles	Code	Termination
-------------	-------	------	-------------

PXMBNI23FIM12ASC	12	A	Screw Terminal
PXMBNI23FIM19ASC	19	A	Screw Terminal

M23 Flex Body Female



PXMBNI23FBF

- Available in 12 and 19 poles
- Solder termination
- Metal Flex Body
- Mates with panel mount connectors

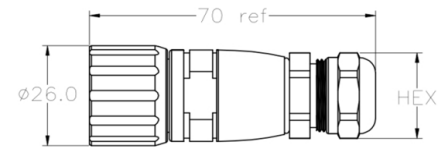

Part Number	Poles	Code	Termination
-------------	-------	------	-------------

PXMBNI23FBF12ASC	12	A	Screw Terminal
PXMBNI23FBF19ASC	19	A	Screw Terminal

M23 Right Angled Female



PXMBNI23RAF

- Available in 12 and 19 poles
- Solder termination
- Metal Right Angle Flex Body
- Mates with panel mount connectors

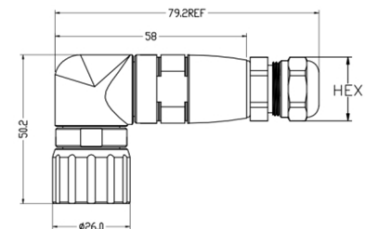

Part Number	Poles	Code	Termination
-------------	-------	------	-------------

PXMBNI23RAF12ASC	12	A	Screw Terminal
PXMBNI23RAF19ASC	19	A	Screw Terminal

M23 Front Panel Mounting Male



PXMBNI23FPM

- Available in 12 and 19 poles
- Solder termination
- Front panel M20
- Mates with Flex Body connectors

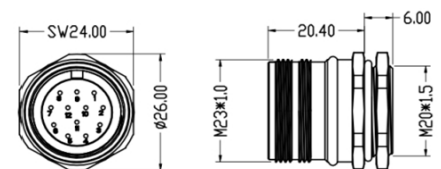

Part Number	Poles	Code	Termination
-------------	-------	------	-------------

PXMBNI23FPM12ASC	12	A	Screw Terminal
PXMBNI23FPM19ASC	19	A	Screw Terminal

**Electrical**

No. Poles:	12	19
Current Rating:	8A	8A
Voltage Rating (ac/dc) :	200V	200V
Contact Resistance:	<3mΩ	
Insulation Resistance:	>100 <sup>3</sup> MΩ	
AC Breakdown Voltage:		
12 Pole	1.5KV	
19 Pole	1.5KV	
Operating Temp Range:	-25°C to 80°C	

**Mechanical:**

Locking Mechanism:	Screw coupling
Sealing:	IP67
Contact Accomodation:	
12 Pole	18 AWG
19 Pole	17 AWG
Cable Acceptance:	6.0 - 8.0mm Dia
Terminations:	Solder
Mechanical Operation:	500 mating cycles
Diameter over coupling ring:	26.0mm

**Materials:**

Body:	Nickel Plated Brass
Coupling Nut:	Nickel Plated Brass
Colour:	Grey
Pin Contacts:	Brass, Gold plating
Socket Contacts:	Phosphor Bronze, Gold plating
O Rings & Gaskets:	Viton
RoHS:	Compliant

**Panel Mount:**

**Flex & Inline Connectors:**

Body:	Nickel Plated Brass
Coupling Nut:	Nickel Plated Brass
Colour:	Grey
Pin Contacts:	Brass, Gold plating
Socket Contacts:	Phosphor Bronze, Gold plating
O Rings & Gaskets:	Viton
RoHS:	Compliant

MX	XXX	XX	XX	X	XX	X	XX
Series	Material	Series Size	Body Style	Orientation	NO. Contacts	Code	Termination
PXM	BNI = Brass Nickel	23	FB = Flex Body	M	12	A	SC = Solder
PXP			FI = Flex Inline Body FP = Front Panel Mounting RA = Right Angle	F	19		

Passive distribution boxes provide a **convenient and compact connectivity solution** that can be installed quickly and easily in the field. They offer considerable **cost saving benefits** when compared to hard-wiring I/O connections due to their pre-wired connector slot configurations which enables numerous **sensor and actuator signals** to be transmitted back to a control system with ease.

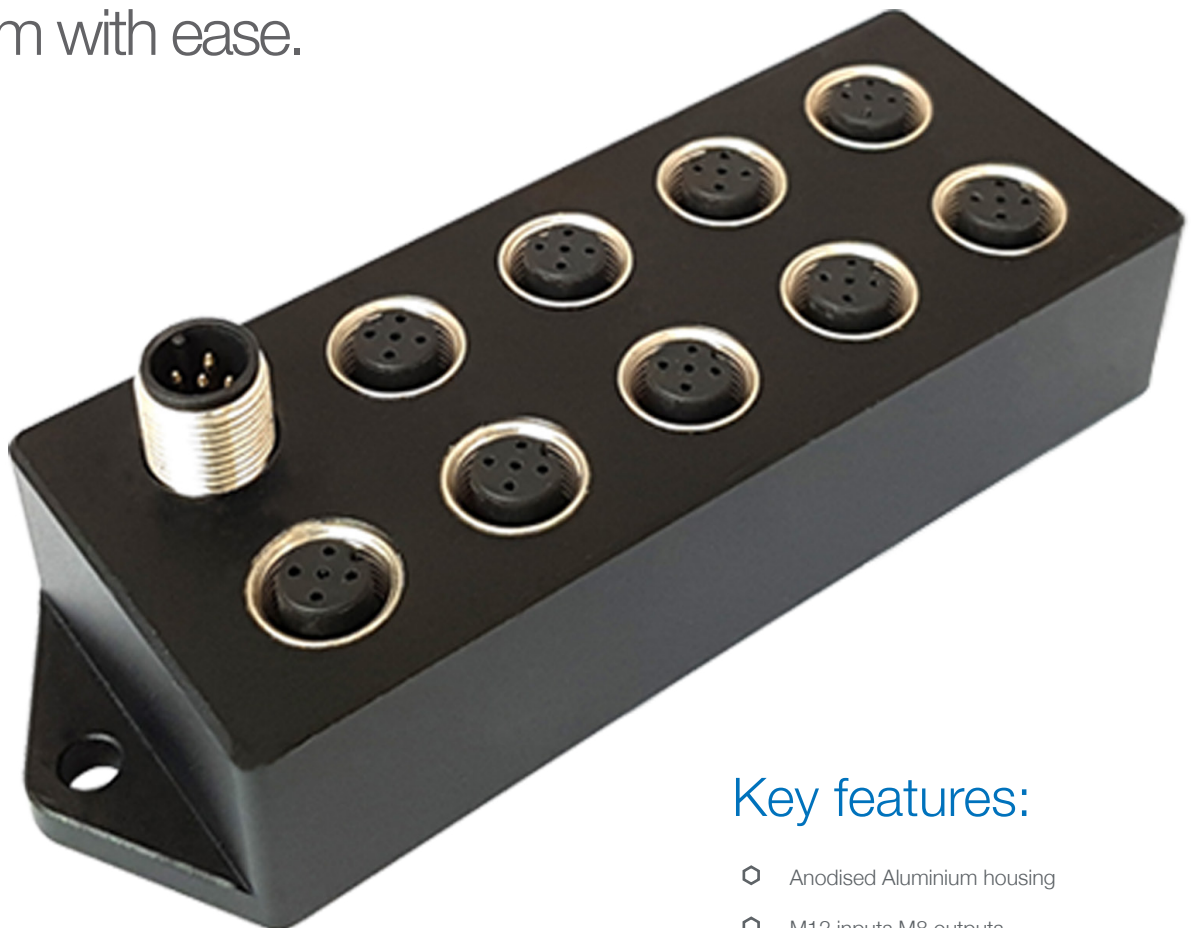

### Key features:

- Anodised Aluminium housing
- M12 inputs M8 outputs
- Available with or without LED indicators
- IP67 rated
- 5, 8, and 9 port configurations
- Operating Temp Range -25°C to 80°C

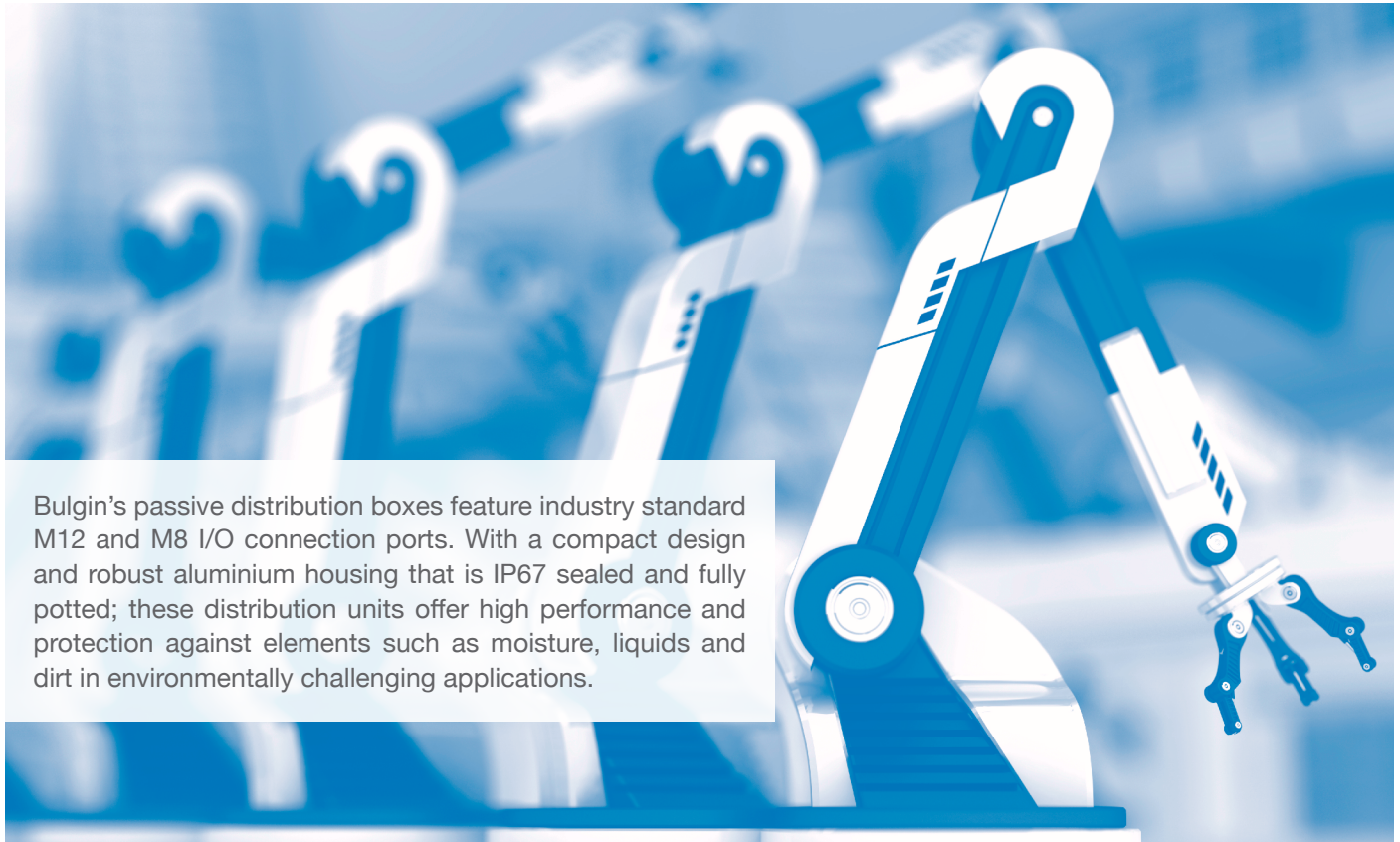

Bulgin's passive distribution boxes feature industry standard M12 and M8 I/O connection ports. With a compact design and robust aluminium housing that is IP67 sealed and fully potted; these distribution units offer high performance and protection against elements such as moisture, liquids and dirt in environmentally challenging applications.

## The Benefits:



### Save Time

With the need to hard wire I/O connections removed and variants coming equipped with identification labels and integrated LEDs, Bulgin's distribution boxes help to save on costs associated with installation, maintenance and repair time by making it easy and quick to troubleshoot connection faults.

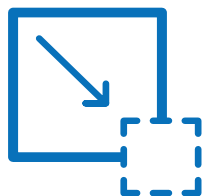

### Save Space

Distribution boxes save space in the field as they require less space than more conventional distribution systems due to their compact design. They take up far less space than loose wires and require fewer terminal blocks/boxes, making them the ideal solution for many machine requirements or automation systems.



### Save Money

By simplifying the wiring control system and eliminating the need for additional enclosures, distributor boxes can be installed quickly which saves time and costs. Their ability to reduce troubleshooting time also means that downtime can be significantly minimised in manufacturing, food-processing and industrial automation applications.



BOX1M1205MA05

- 5 outputs
- Sealed using sealing caps
- Anodised aluminium body
- Mates with Flex Body and Flex Inline connectors

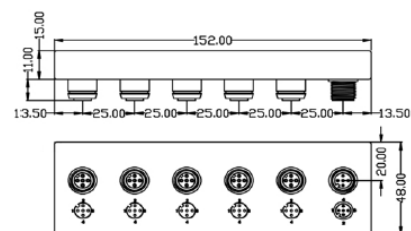

Part Number	Input Type	Input Pole Count	Output Type	Output Pole Count	Output Ports
BOX1M1205MA05M805F	M12	5 Contacts	M8	5 Contacts	5 Ports



BOX1M1212MA08

- 8 outputs
- Sealed using sealing caps
- Anodised aluminium body
- Mates with Flex Body and Flex Inline connectors

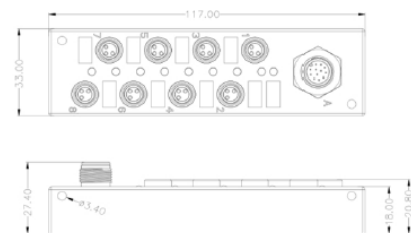

Part Number	Input Type	Input Pole Count	Output Type	Output Pole Count	Output Ports
BOX1M1212MA08M803F	M12	12 Contacts	M8	3 Contacts	8 Ports



BOX1M1205MA09

- 9 outputs
- Sealed using sealing caps
- Anodised aluminium body
- Mates with Flex Body and Flex Inline connectors

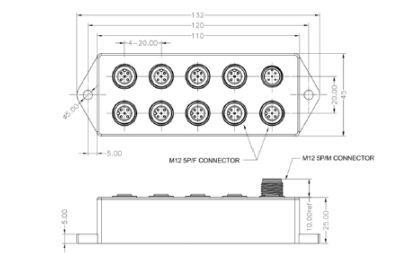

Part Number	Input Type	Input Pole Count	Output Type	Output Pole Count	Output Ports
BOX1M1205MA09M805F	M12	5 Contacts	M8	5 Contacts	9 Ports

**Specifications:**

Locking mechanism: Screw coupling  
 Sealing: IP67  
 Operating Temp Range: -25°C to 80°C

**Materials:**

Body: Anodised Aluminium  
 Colour: Black  
 Pin Contacts: Brass, Gold plating  
 Socket Contacts: Phosphor Bronze, Gold plating  
 RoHS: Compliant

**Box & Panel Mount:**

**Wiring diagram for BOX1M1212MA08M803F**

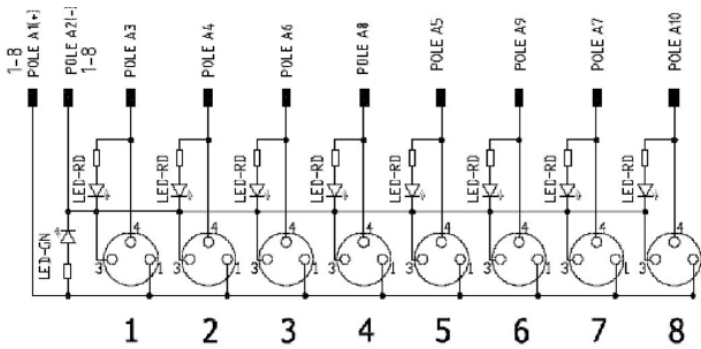

<b>BOX</b>	<b>X</b>	<b>XX</b>	<b>XX</b>	<b>X</b>	<b>X</b>	<b>XX</b>	<b>XX</b>	<b>XX</b>	<b>X</b>
<b>Series</b>	<b>Inputs</b>	<b>Input Series</b>	<b>Input Poles</b>	<b>Orientation</b>	<b>Code</b>	<b>Outputs</b>	<b>Output Series</b>	<b>Output Poles</b>	<b>Orientation</b>
Box	1	M12	05 12	M	A	05 08 09	M8	03 05	F

Manufactured from **Stainless Steel**, Bulgin's **extensive range** of vandal resistant security switches are designed with a **high resistance** to wear and tear, corrosion and harsh use in potentially hostile environments such as access control applications.

The front and rear panel mounted versions have three profiles –prominent, domed and low profile – with a choice of switching and IP66 & IP68 front panel sealing which combined together to meet the ergonomic, electrical and environmental demands of switch panel design.

And where the ultimate strength of steel is not needed, there is a brass, chrome plated alternative. The low profile style switches are now also available with a latching, push on - push off, action.

The illuminated versions are available in dot and ring LED indication and a variety of illumination colours including bi-colour LED's. Newer versions also feature LED illumination driven by 6V, 12V & 24V together with rear of panel sealing, these options will add that extra dimension to control panel layouts and functionality.

Vandal Resistant	144-162
Push Button	163-173
Voltage Selectors	174
Piezo	175-180
12mm Switches	181-186
Rocker Switches	187-213
Toggle Switches	214-218
Refrigerator Switches	219-224
Slide Switches	225-229



## Front Panel Mounting



MP0027

- 28mm diameter
- S.P.C.O. Microswitch
- 5A, 250Vac

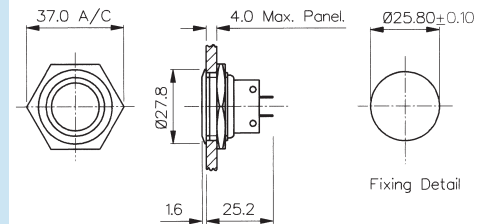

## Front Panel Mounting

MP0038  
Sealed to IP66

- Front Panel Sealed to IP66
- 28mm diameter
- S.P.C.O. Microswitch
- 5A, 250Vac

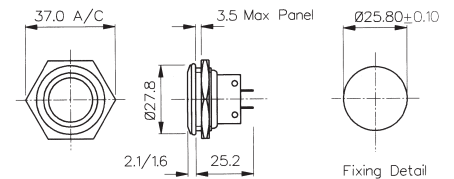

Specifications	MP0027	MP0038
Terminations:	Solder Tags	Solder Tags
Switching:	S.P.C.O. Momentary Action (Microswitch)	S.P.C.O. Momentary Action (Microswitch)
Max. Rating:	5A, 250Vac 2A, 28Vdc	5A, 250Vac 2A, 28Vdc
Contact Resistance:	<10mΩ	<10mΩ
Insulation Resistance:	>10 <sup>3</sup> MΩ	>10 <sup>3</sup> MΩ
Dielectric Strength:	>2.0kVac	>2.0kVac
Operating Temp. Range:	-20°C to +70°C	-20°C to +70°C
Sealing (Front of panel only):		Protection Classification: IP66 EN60529-1:1992 + A2:2013. (Micro switch not sealed)
Operations Mechanical:	1,000,000 (min)	1,000,000 (min)
Electrical:	35,000 (min)	35,000 (min)
Operating Pressure:	7.5N (typ)	12.5N (typ)
Rear Nut Fixing Torque:	2.5Nm	1.13Nm
Materials Mouldings:	Glass Filled Nylon	Glass Filled Nylon
Tags/Terminations:	Brass, Tin Plated	Brass, Tin Plated
Switch Body & Button:	Stainless Steel	Stainless Steel
Contacts:	Fine Silver	Fine Silver
Thread size:	1.0" x 26TPI	1.0" x 26TPI
<b>RoHS</b>	Compliant	Compliant



## Front Panel Mounting

**MP0037**  
 Sealed to IP68

- Front Panel Sealed to IP68
- 21.5mm diameter
- S.P. Push to Make
- 1A, 50Vac/dc
- Industry Standard Size

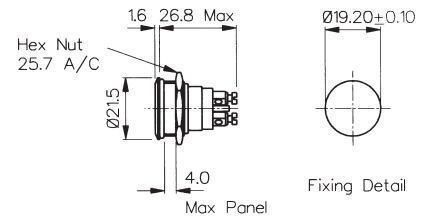

## Front Panel Mounting

**MP0031**  
 Sealed to IP66

- Front Panel Sealed to IP66
- 21.5mm diameter
- S.P.C.O. Microswitch
- 5A, 250Vac

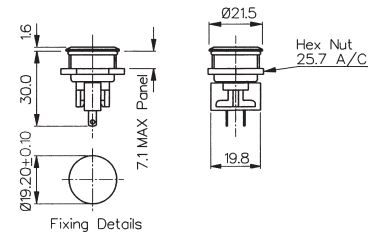

## Specifications

## MP0037

## MP0031

Terminations:	Screw Terminals	Solder Tags
Switching:	S.P. Push to make Momentary action	S.P.C.O. Momentary Action (Microswitch)
Max. Rating:	1A, 50Vac/dc	5A, 250Vac 2A, 28Vdc
Contact Resistance:	<10mΩ	<10mΩ
Insulation Resistance:	>10 <sup>5</sup> MΩ	>10 <sup>3</sup> MΩ
Dielectric Strength:	>1.0kVac	>2.0kVac
Operating Temp. Range:	-20°C to +70°C	-20°C to +70°C
Sealing (Front of panel only):	Protection Classification: IP68 EN 60529:1992+A2:2013 (Micro switch not sealed)	Protection Classification: IP66 EN60529-1:1992 + A2:2013. (Micro switch not sealed)
IP68 rating 10M for 2 weeks test:	Passed	
Operations		
Mechanical:	1,000,000 (min)	1,000,000 (min)
Electrical:	30,000 (min)	35,000 (min)
Operating Pressure:	7.5N (typ)	4.7N (typ)
Rear Nut Fixing Torque:	0.57Nm	0.57Nm
Materials		
Mouldings:	Glass Filled Nylon	Glass Filled Nylon
Tags/Terminations:	Brass, Silver Plated	Brass, Tin Plated
Switch Body & Button:	Stainless Steel	Stainless Steel
Contacts:	Brass, Silver Plated, Silver	Fine Silver
Thread size:	0.747" x 26TPI	0.747" x 26TPI
<b>RoHS</b>	Compliant	Compliant

## Front Panel Mounting



MPI001 - front panel seal to IP66

- Dot illumination
- 22mm diameter
- Single pole push to make
- 50mA, 24Vdc contact rating
- Red, Green, Amber, Blue, White or dual colour illumination
- Bright daylight LEDs
- Independent LED terminals
- Front panel seal to IP66
- Integral supply resistors
- TVS protection

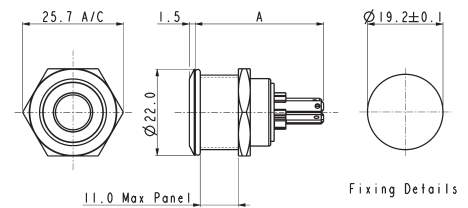

MPI001/TAG/COL A = 32.7  
 MPI001/TERM/COL A = 31.0 MAX.

## Specifications

## MPI001/Termination/Colour/Voltage

Illumination style:	Dot							
Terminations:	/28 (2.8mm tabs), /TERM or /TE (screw terminals)							
Switching:	Single pole, push to make, tactile (momentary action)							
Max. Switch Rating:	50mA, 24Vdc							
LEDs (ratings @ 20mA)								
Part No.	/RD	/GN	/AM	/BL	/WH	/D1	/D4	/D5
Colours	Red	Green	Amber	Blue	White	Red/Green	Red/Blue	Green/Blue
Luminous Intensity	900mcd	2500mcd	900mcd	1500mcd	900mcd	2500mcd/5000mcd	2000mcd/850mcd	4000mcd/2000mcd
Forward Voltage	1.85V	3.5V	2.3V	3.5V	3.6V	2.05V/3.6V	2.0V/3.6V	3.6V/3.6V
Forward Current	20mA	20mA	20mA	20mA	20mA	20mA	20mA	20mA
Moulding Colour	Red	Green	Amber	Blue	White	Black	Black	Black
Illumination Voltage:	/no suffix No resistor fitted. <b>An appropriate resistor must be series connected by the user.</b> Voltages as above.							
	/6	6Vdc						
	/12	12Vdc						
	/24	24Vdc						
Contact Resistance:	<100mΩ							
Insulation Resistance:	>10 <sup>9</sup> MΩ							
Dielectric Strength:	Contact to Panel >2.0kV Contact to Contact 1500							
Operating Temp. Range:	-30°C to +70°C							
Sealing (Front of panel only):	Protection Classification: IP66 EN60529-1:1992 + A2:2013. (Micro switch not sealed)							
Operations								
Mechanical:	750,000 (min)							
Electrical:	35,000 (min)							
Operating Pressure:	12N							
Rear Nut Fixing Torque:	0.57Nm							
Screw Terminal Torque	0.2Nm Max							
Materials								
Switch assembly:	UL94V-0 rated Polyamide (Nylon)							
Tags:	Copper Alloy							
Terminals:	Copper Alloy							
Switch Body & Button:	Stainless Steel							
Lens and Lens Body:	Polycarbonate							
O ring:	Nitrile							
Internal seal:	Silicone							
Contact Plate:	Gold Plated							
Thread size:	18.97mm x 26TPI							

ESD Handling precautions must be taken  
 Compliant

## Dual Colour LED Configuration

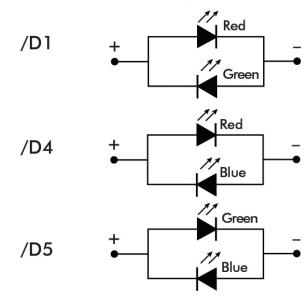

## Front Panel Mounting



MPI002- front panel seal to IP66

- Ring illumination
- 22mm diameter
- Single pole push to make
- 50mA, 24Vdc contact rating
- Red, Green, Amber, Blue, White or dual colour illumination
- Bright daylight LEDs
- Independent LED terminals
- Front panel seal to IP66
- Integral supply resistors
- TVS protection

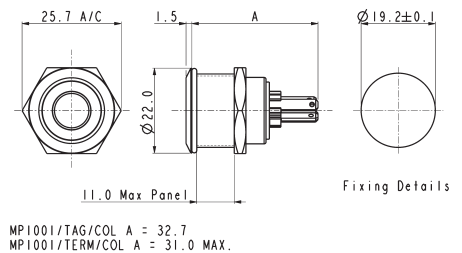

## Specifications

## MPI002/Termination/Colour/Voltage

<b>Terminations:</b> /28 (2.8mm tabs), /TERM or /TE (screw terminals)									
<b>Switching:</b> Single pole, push to make, tactile (momentary action)									
<b>Max. Switch Rating:</b> 50mA, 24Vdc									
<b>LEDs (ratings @ 20mA)</b> Part No. Colours Luminous Intensity Forward Voltage Forward Current Moulding Colour	/RD	/GN	/AM	/BL	/WH	/D1	/D4	/D5	/D6
	Red	Green	Amber	Blue	White	Red/Green	Red/Blue	Green/Blue	Green/White
	900mcd	2500mcd	900mcd	1500mcd	900mcd	2500mcd/5000mcd	2000mcd/850mcd	4000mcd/2000mcd	178mcd/450mcd
	1.85V	3.5V	2.3V	3.5V	3.6V	2.05V/3.6V	2.0V/3.6V	3.6V/3.6V	3.4V/3.2V
	20mA	20mA	20mA	20mA	20mA	20mA	20mA	20mA	20mA
	Red	Green	Amber	Blue	White	Black	Black	Black	Black
<b>Illumination Voltage:</b>	/no suffix No resistor fitted. <b>An appropriate resistor must be series connected by the user.</b> Voltages as above. /6 6Vdc /12 12Vdc /24 24Vdc								
<b>Contact Resistance:</b> <b>Insulation Resistance:</b> <b>Dielectric Strength:</b>	<100mΩ >10 <sup>3</sup> MΩ Contact to Panel >2.0kV Contact to Contact 1500								
<b>Operating Temp. Range:</b> <b>Sealing (Front of panel only):</b> <b>Operations</b> <b>Mechanical:</b> <b>Electrical:</b>	-30°C to +70°C Protection Classification: IP66 EN60529-1:1992 + A2:2013. (Micro switch not sealed) 750,000 (min) 35,000 (min)								
<b>Operating Pressure:</b> <b>Rear Nut Fixing Torque:</b>	12N 0.57Nm								
<b>Screw Terminal Torque</b>	0.2Nm Max								

## Materials

Switch assembly:	UL94V-0 rated Polyamide (Nylon)
Tags:	Copper Alloy
Terminals:	Copper Alloy
Switch Body & Button:	Stainless Steel
Lens and Lens Body:	Polycarbonate
O ring:	Nitrile
Internal seal:	Silicone
Contact Plate:	Gold Plated
Thread size:	18.97mm x 26TPI

ESD Handling precautions must be taken  
Compliant



## Dual Colour LED Configuration

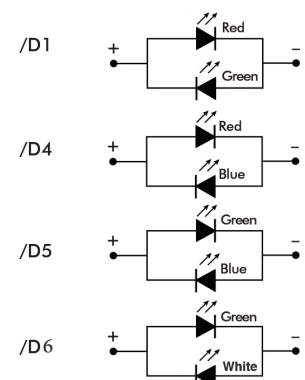

## Rear Panel Sealed - Flying Leads



MPI002/FL/xx/x

- Ring illumination
- 22mm diameter
- Single pole push to make
- 50mA, 24Vdc contact rating
- Red, Green, Amber, Blue, White or dual colour illumination
- Bright daylight LEDs
- Independent LED terminals
- Front panel seal to IP66
- Integral supply resistors
- TVS protection

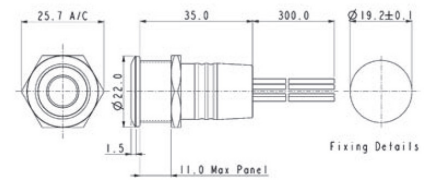

Flying lead colours: LED: red + and black -. Switch contacts: white.

## Rear Panel Sealed - Solder Tags



MPI001/RP/xx/x

- Dot or ring illumination
- 22mm diameter
- Single pole push to make
- 50mA, 24Vdc contact rating
- Red, Green, Amber, Blue & White illumination
- Bright daylight LEDs
- Independent LED terminals
- Front and rear panel seal to IP66
- Solder tag termination
- TVS protection

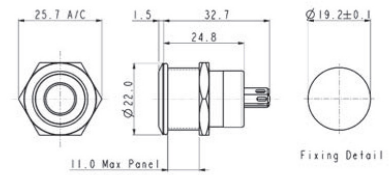

LED terminals marked + and -. Switch terminals unmarked.

## Specifications

## MPI001/Termination/Colour/Voltage

Terminations:	/FL (Flying leads) /RP (Solder tags)				
Switching:	Single pole, push to make, tactile (momentary action)				
Max. Switch Rating:	50mA, 24Vdc				
LEDs (ratings @ 20mA)					
Part No.	/RD	/GN	/AM	/BL	/WH
Colours	Red	Green	Amber	Blue	White
Luminous Intensity	900mcd	2500mcd	900mcd	1500mcd	900mcd
Forward Voltage	1.85V	3.5V	2.3V	3.5V	3.6V
Forward Current	20mA	20mA	20mA	20mA	20mA
Moulding Colour	Red	Green	Amber	Blue	White

illumination style:	Dot
Terminations:	/FL (Flying leads) /RP (Solder tags)
Switching:	Single pole, push to make, tactile (momentary action)
Max. Switch Rating:	50mA, 24Vdc

LEDs (ratings @ 20mA)	
Part No.	/RD /GN /AM /BL /WH
Colours	Red Green Amber Blue White
Luminous Intensity	900mcd 2500mcd 900mcd 1500mcd 900mcd
Forward Voltage	1.85V 3.5V 2.3V 3.5V 3.6V
Forward Current	20mA 20mA 20mA 20mA 20mA
Moulding Colour	Red Green Amber Blue White

illumination Voltage:	/no suffix No resistor fitted. An appropriate resistor must be series connected by the user. Voltages as above.
	/6 6Vdc
	/12 12Vdc
	/24 24Vdc

Contact Resistance:	<100mΩ
Insulation Resistance:	>10 <sup>9</sup> MΩ
Dielectric Strength:	Contact to Panel >2.0kV Contact to Contact 1500
Operating Temp. Range:	-30°C to +70°C
Sealing (Front of panel only):	Protection Classification: IP66 EN60529-1:1992 + A2:2013. (Micro switch not sealed)

Operations	
Mechanical:	750,000 (min)
Electrical:	35,000 (min)

Operating Pressure:	12N
Rear Nut Fixing Torque:	0.57Nm

Materials	
Switch assembly:	UL94V-0 rated Polyamide (Nylon)
Tags:	Copper Alloy
Terminals:	Copper Alloy
Switch Body & Button:	Stainless Steel
Lens and Lens Body:	Polycarbonate
O ring:	Nitrile
Internal seal:	Silicone
Contact Plate:	Gold Plated
Thread size:	18.97mm x 26TPI

ESD Handling precautions must be taken  
Compliant



## MPI002/Termination/Colour/Voltage

Terminations:	/FL (Flying leads) /RP (Solder tags)				
Switching:	Single pole, push to make, tactile (momentary action)				
Max. Switch Rating:	50mA, 24Vdc				
LEDs (ratings @ 20mA)					
Part No.	/RD	/GN	/AM	/BL	/WH
Colours	Red	Green	Amber	Blue	White
Luminous Intensity	900mcd	2500mcd	900mcd	1500mcd	900mcd
Forward Voltage	1.85V	3.5V	2.3V	3.5V	3.6V
Forward Current	20mA	20mA	20mA	20mA	20mA
Moulding Colour	Red	Green	Amber	Blue	White

illumination style:	Ring
Terminations:	/FL (Flying leads) /RP (Solder tags)
Switching:	Single pole, push to make, tactile (momentary action)
Max. Switch Rating:	50mA, 24Vdc

illumination Voltage:	/no suffix No resistor fitted. An appropriate resistor must be series connected by the user. Voltages as above.
	/6 6Vdc
	/12 12Vdc
	/24 24Vdc

Contact Resistance:	<100mΩ
Insulation Resistance:	>10 <sup>9</sup> MΩ
Dielectric Strength:	Contact to Panel >2.0kV Contact to Contact 1500
Operating Temp. Range:	-30°C to +70°C
Sealing (Front of panel only):	Protection Classification: IP66 EN60529-1:1992 + A2:2013. (Micro switch not sealed)

Operations	
Mechanical:	750,000 (min)
Electrical:	35,000 (min)

Operating Pressure:	12N
Rear Nut Fixing Torque:	0.57Nm

Materials	
Switch assembly:	UL94V-0 rated Polyamide (Nylon)
Tags:	Copper Alloy
Terminals:	Copper Alloy
Switch Body & Button:	Stainless Steel
Lens and Lens Body:	Polycarbonate
O ring:	Nitrile
Internal seal:	Silicone
Contact Plate:	Gold Plated
Thread size:	18.97mm x 26TPI

ESD Handling precautions must be taken  
Compliant

## Front Panel Mounting

**MPB038**  
 Sealed to IP66

- Front Panel Sealed to IP66
- 28mm diameter
- S.P.C.O. Microswitch
- 5A, 250Vac

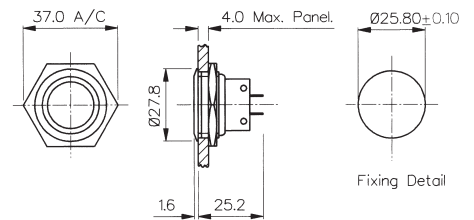

## Front Panel Mounting

**MPB031**  
 Sealed to IP66

- Front Panel Sealed to IP66
- 21mm diameter
- S.P.C.O. Microswitch
- 5A, 250Vac

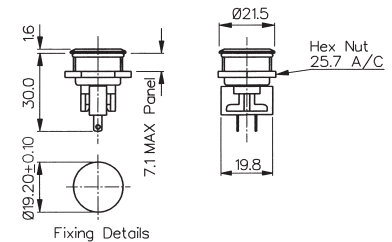

## Front Panel Mounting

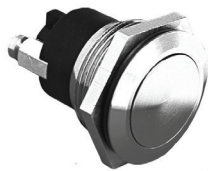
**MPB037**  
 Sealed to IP68

- Front Panel Sealed to IP68
- 21.5mm diameter
- S.P. Push to Make
- 1A, 50Vac/dc

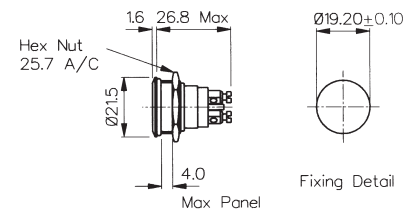

Specifications	MPB038	MPB031	MPB037
Terminations:	Solder Tags	Solder Tags	Screw Terminals
Switching:	S.P.C.O. Momentary Action (Microswitch)	S.P.C.O. Momentary Action (Microswitch)	S.P. Push to make Momentary action
Max. Rating:	5A, 250Vac. 2A, 28Vdc	5A, 250Vac. 2A, 28Vdc	1A, 50Vac/dc
Contact Resistance:	<10mΩ	<10mΩ	<10mΩ
Insulation Resistance:	>10 <sup>3</sup> MΩ	>10 <sup>3</sup> MΩ	>10 <sup>5</sup> MΩ
Dielectric Strength:	>2.0kVac	>2.0kVac	>1.0kVac
Operating Temp. Range:	-20°C to +70°C	-20°C to +70°C	-20°C to +70°C
Sealing (Front of panel only):	Protection Classification: IP66 EN60529-1:1992 + A2:2013. (Micro switch not sealed)	Protection Classification: IP66 EN60529-1:1992 + A2:2013. (Micro switch not sealed)	Protection Classification: IP68 EN60529-1:1992 + A2:2013. (Micro switch not sealed) (10m for 2 weeks)
Operations			
Mechanical:	1,000,000 (min)	1,000,000 (min)	1,000,000 (min)
Electrical:	35,000 (min)	35,000 (min)	30,000 (min)
Operating Pressure:	12.5N (typ)	4.7N (typ)	7.5N (typ)
Rear Nut Fixing Torque:	1.13Nm	0.57Nm	0.57Nm
Materials			
Mouldings:	Glass Filled Nylon	Glass Filled Nylon	Glass Filled Nylon
Tags/Terminations:	Brass, Tin Plated	Brass, Tin Plated	Brass, Tin Plated
Switch Body & Button:	Brass	Brass	Brass
Contacts:	Fine Silver	Fine Silver	Brass, Silver Plated, Silver
Thread size:	1.0" x 26TPI	0.747" x 26TPI	0.747" x 26TPI
RoHS	Compliant	Compliant	Compliant

## Front Panel Mounting - Low Profile



MP0050

- Front Panel Sealed to IP68
- Flush button
- 32.0mm diameter
- S.P.C.O. switching
- Momentary action
- 5A, 250Vac

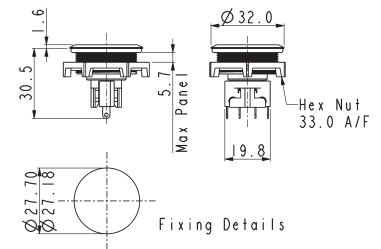

## Front Panel Mounting - Protruding Profile



MP0050/2

- Front Panel Sealed to IP68
- Protruding button
- 32.0mm diameter
- S.P.C.O. switching
- Momentary action
- 5A, 250Vac

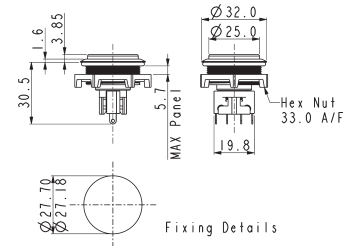

Specifications	MP0050	MP0050/2
Terminations:	Solder Tags	Solder Tags
Switching:	S.P.C.O. Momentary Action (Microswitch)	S.P.C.O. Momentary Action (Microswitch)
Max. Rating:	5A, 250Vac. 2A, 28Vdc	5A, 250Vac. 2A, 28Vdc
Contact Resistance:	<10mΩ	<10mΩ
Insulation Resistance:	>10 <sup>3</sup> MΩ	>10 <sup>3</sup> MΩ
Dielectric Strength:	>2.0kVac	>2.0kVac
Operating Temp. Range:	-20°C to +70°C	-20°C to +70°C
Sealing (Front of panel only):	Protection Classification: IP66 EN60529-1:1992 + A2:2013. (Micro switch not sealed)	Protection Classification: IP66 EN60529-1:1992 + A2:2013. (Micro switch not sealed)
Operations Mechanical:	1,000,000 (min)	1,000,000 (min)
Electrical:	35,000 (min)	35,000 (min)
Operating Pressure:	4.7Nm	4.7N (typ)
Rear Nut Fixing Torque:	0.57Nm	0.57Nm
Materials Mouldings:	Glass Filled Nylon	Glass Filled Nylon
Tags/Terminations:	Brass, Tin Plated	Brass, Tin Plated
Switch Body & Button:	Stainless Steel	Stainless Steel
Contacts:	Fine Silver	Fine Silver
Thread size:	M27 x 1.0-6H	M27 x 1.0-6H
<b>RoHS</b>	Compliant	Compliant

## Front Panel Mounting



MP0027/3

- 28mm diameter
- Domed Profile
- S.P.C.O. Microswitch
- 5A, 250Vac

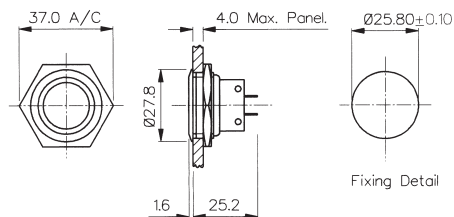

## Front Panel Mounting

MP0038/3  
Sealed to IP66

- Front Panel Sealed to IP66
- 28mm diameter
- Domed Profile
- S.P.C.O. Microswitch
- 5A, 250Vac

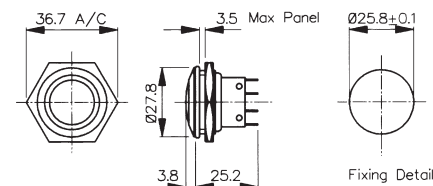

## Specifications

## MP0027/3

## MP0038/3

Terminations:	Solder Tags	Solder Tags
Switching:	S.P.C.O. Momentary Action (Microswitch)	S.P.C.O. Momentary Action (Microswitch)
Max. Rating:	5A, 250Vac. 2A, 28Vdc	5A, 250Vac. 2A, 28Vdc
Contact Resistance:	<10mΩ	<10mΩ
Insulation Resistance:	>10 <sup>9</sup> MΩ	>10 <sup>9</sup> MΩ
Dielectric Strength:	>2.0kVac	>2.0kVac
Operating Temp. Range:	-20°C to +70°C	-20°C to +70°C
Sealing (Front of panel only):		Protection Classification: IP66 EN60529-1:1992 + A2:2013. (Micro switch not sealed)
Operations		
Mechanical:	1,000,000 (min)	1,000,000 (min)
Electrical:	35,000 (min)	35,000 (min)
Operating Pressure:	7.5N (typ)	12.5N (typ)
Rear Nut Fixing Torque:	2.5Nm	1.13Nm
Materials		
Mouldings:	Glass Filled Nylon	Glass Filled Nylon
Tags/Terminations:	Brass, Tin Plated	Brass, Tin Plated
Switch Body & Button:	Stainless Steel	Stainless Steel
Contacts:	Fine Silver	Fine Silver
Thread size:	1.0" x 26TPI	0.747" x 26TPI
<b>RoHS</b>	Compliant	Compliant

## Front Panel Mounting

**MP0037/3**  
 Sealed to IP68

- Front Panel Sealed to IP68
- 21.5mm diameter
- Domed Profile
- S.P. Push to Make
- 1A, 50Vac/dc

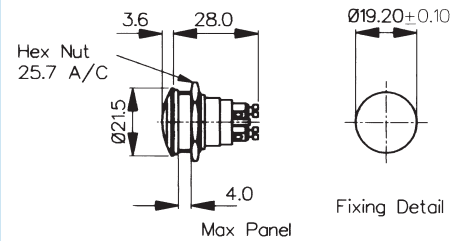

## Front Panel Mounting

**MP0031/3**  
 Sealed to IP66

- Front Panel Sealed to IP66
- 21.5mm diameter
- Domed Profile
- S.P.C.O. Microswitch
- 5A, 250Vac

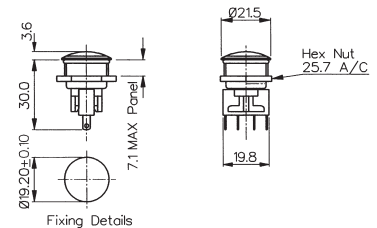

Specifications	MP0037/3	MP0031/3
Terminations:	Screw Terminals	Solder Tags
Switching:	S.P. Push to make Momentary action	S.P.C.O. Momentary Action (Microswitch)
Max. Rating:	1A, 50Vac/dc	5A, 250Vac. 2A, 28Vdc
Contact Resistance:	<10mΩ	<10mΩ
Insulation Resistance:	>10 <sup>5</sup> MΩ	>10 <sup>3</sup> MΩ
Dielectric Strength:	>1.0kVac	>2.0kVac
Operating Temp. Range:	-20°C to +70°C	-20°C to +70°C
Sealing (Front of panel only):	Protection Classification: IP68 EN60529-1:1992 + A2:2013. (Micro switch not sealed) (10m for 2 weeks)	Protection Classification: IP66 EN60529-1:1992 + A2:2013. (Micro switch not sealed)
Operations		
Mechanical:	1,000,000 (min)	1,000,000 (min)
Electrical:	35,000 (min)	35,000 (min)
Operating Pressure:	7.5N (typ)	4.7N (typ)
Rear Nut Fixing Torque:	2.5Nm	0.57Nm
Materials		
Mouldings:	Glass Filled Nylon	Glass Filled Nylon
Tags/Terminations:	Brass, Tin Plated	Brass, Tin Plated
Switch Body & Button:	Stainless Steel	Stainless Steel
Contacts:	Brass, Silver Plated, Silver	Fine Silver
Thread size:	0.747" x 26TPI	0.747" x 26TPI
<b>RoHS</b>	Compliant	Compliant



## Front Panel Mounting



MP0027/2

- 28mm diameter
- Prominent Button
- S.P.C.O. Microswitch
- 5A, 250Vac

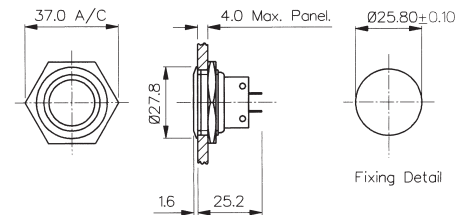

## Front Panel Mounting

MP0038/2  
Sealed to IP66

- Front Panel Sealed to IP66
- 28mm diameter
- Prominent Button
- S.P.C.O. Microswitch
- 5A, 250Vac

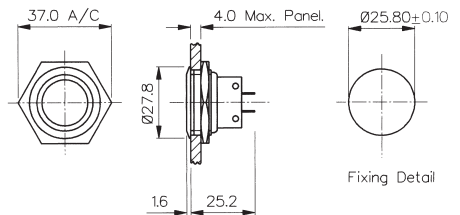

Specifications	MP0027/2	MP0038/2
Terminations:	Solder Tags	Solder Tags
Switching:	S.P.C.O. Momentary Action (Microswitch)	S.P.C.O. Momentary Action (Microswitch)
Max. Rating:	5A, 250Vac 2A, 28Vdc	5A, 250Vac. 2A, 28Vdc
Contact Resistance:	<10mΩ	<10mΩ
Insulation Resistance:	>10 <sup>3</sup> MΩ	>10 <sup>3</sup> MΩ
Dielectric Strength:	>2.0kVac	>2.0kVac
Operating Temp. Range:	-20°C to +70°C	-20°C to +70°C
Sealing (Front of panel only):		Protection Classification: IP66 EN60529-1:1992 + A2:2013. (Micro switch not sealed)
Operations		
Mechanical:	1,000,000 (min)	1,000,000 (min)
Electrical:	35,000 (min)	35,000 (min)
Operating Pressure:	7.5N (typ)	12.5N (typ)
Rear Nut Fixing Torque:	2.5Nm	1.13Nm
Materials		
Mouldings:	Glass Filled Nylon	Glass Filled Nylon
Tags/Terminations:	Brass, Tin Plated	Brass, Tin Plated
Switch Body & Button:	Stainless Steel	Stainless Steel
Contacts:	Fine Silver	Fine Silver
Thread size:	1.0" x 26TPI	1.0" x 26TPI
<b>RoHS</b>	Compliant	Compliant

## Front Panel Mounting

**MP0037/2**  
 Sealed to IP68

- Front Panel Sealed to IP68
- 21.5mm diameter
- Prominent Button
- S.P. Push to Make
- 1A, 50Vac/dc

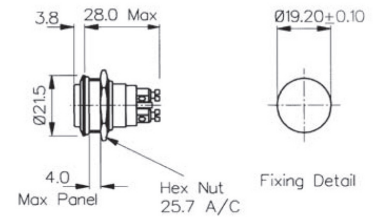

## Front Panel Mounting

**MP0031/2**  
 Sealed to IP66

- Front Panel Sealed to IP66
- 21.5mm diameter
- Prominent Button
- S.P.C.O. Microswitch
- 5A, 250Vac

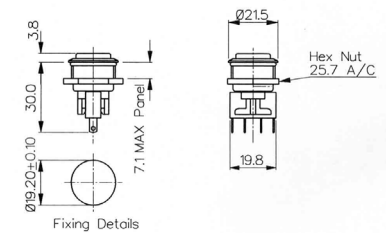

Specifications	MP0037/2	MP0031/2
Terminations:	Screw Terminals	Solder Tags
Switching:	S.P. Push to make Slow momentary action	S.P.C.O. Momentary Action (Microswitch)
Max. Rating:	1A, 50Vac/dc	5A, 250Vac. 2A, 28Vdc
Contact Resistance:	<10mΩ	<10mΩ
Insulation Resistance:	>10 <sup>5</sup> MΩ	>10 <sup>3</sup> MΩ
Dielectric Strength:	>1.0kVac	>2.0kVac
Operating Temp. Range:	-20°C to +70°C	-20°C to +70°C
Sealing (Front of panel only):	Protection Classification: IP68 EN60529-1:1992 + A2:2013. (Micro switch not sealed) (10m for 2 weeks)	Protection Classification: IP66 EN60529-1:1992 + A2:2013. (Micro switch not sealed)
Operations Mechanical:	1,000,000 (min)	1,000,000 (min)
Electrical:	35,000 (min)	35,000 (min)
Operating Pressure:	7.5N (typ)	4.7N (typ)
Rear Nut Fixing Torque:	0.57Nm	0.57Nm
Materials Mouldings:	Glass Filled Nylon	Glass Filled Nylon
Tags/Terminations:	Brass, Tin Plated	Brass, Tin Plated
Switch Body & Button:	Stainless Steel	Stainless Steel
Contacts:	Brass, Silver Plated, Silver	Fine Silver
Thread size:	0.747" x 26TPI	0.747" x 26TPI
<b>RoHS</b>	Compliant	Compliant

Front Panel Mounting



MP0013  
MP0033

- Proud Fitting
- 22mm diameter
- S.P. Push to Make
- 1A, 50V
- Brass, Chrome Plated Body, Stainless Steel Button
- MP0033 Internally Sealed

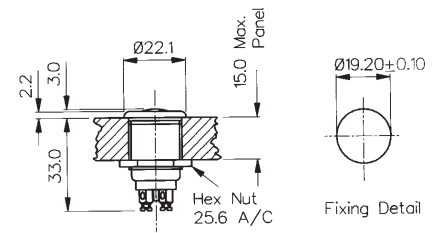

Front Panel Mounting



MP0013/2  
MP0033/2

- Prominent Button
- 22mm diameter
- S.P. Push to Make
- 1A, 50V
- Brass, Chrome Plated Body, Stainless Steel Button
- MP0033/2 Internally Sealed

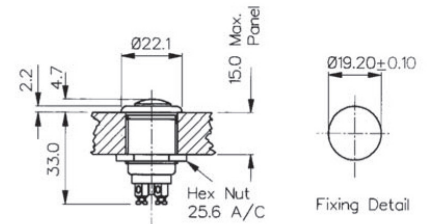

Specifications	MP0013, MP0033	MP0013/2, MP0033/2
Terminations:	Screw Terminals	Screw Terminals
Switching:	S.P. Push to make Slow momentary action	S.P. Push to make Slow momentary action
Max. Rating:	1A, 50Vac/dc	1A, 50Vac/dc
Contact Resistance:	<15mΩ	<15mΩ
Insulation Resistance:	>10 <sup>4</sup> MΩ	>10 <sup>4</sup> MΩ
Dielectric Strength:	>2.5kVac	>2.5kVac
Operating Temp. Range:	-20°C to +85°C	-20°C to +85°C
Sealing (Front of panel only):	MP0033 only - internally sealed against ingress of water and dust	MP0033/2 only - internally sealed against ingress of water and dust
Materials		
Mouldings:	Glass Filled Nylon	Glass Filled Nylon
Tags/Terminations:	Brass, Silver Plated	Brass, Silver Plated
Switch Body & Button:	Body: Brass, Chrome Plated Button: Stainless Steel	Body: Brass, Chrome Plated Button: Stainless Steel
Contacts:	Copper, Silver Plated	Copper, Silver Plated
Thread Size:	0.747" x 26TPI	0.747" x 26TPI
<b>RoHS</b>	Compliant	Compliant

Switches  
Stainless Steel - Momentary



Flush Profile



MP0042/1

- 18mm bezel diameter
- 16mm panel hole
- S.P. Push to make
- Polished finish
- 2A, 48Vdc

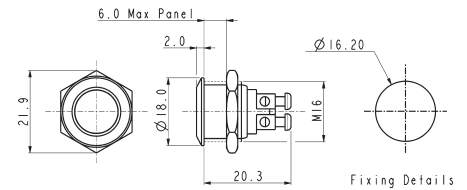

Domed Profile



MP0042/2

- 18mm bezel diameter
- 16mm panel hole
- S.P. Push to make
- Polished finish
- 2A, 48Vdc

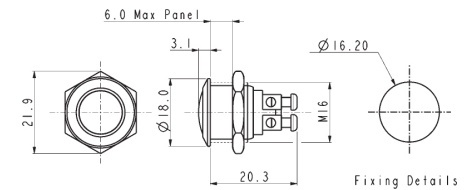

Prominent Button



MP0042/3

- 18mm bezel diameter
- 16mm panel hole
- S.P. Push to make
- Polished finish
- 2A, 48Vdc

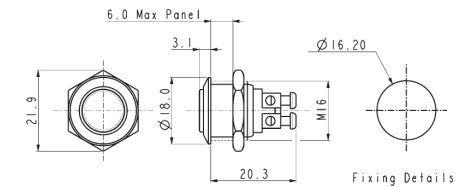

Specifications	MP0042/1	MP0042/2	MP0042/3
Terminations:	Screw Terminals	Screw Terminals	Screw Terminals
Switching:	S.P. Push to make	S.P. Push to make	S.P. Push to make
Max. Rating:	2A, 48Vdc	2A, 48Vdc	2A, 48Vdc
Contact Resistance:	50mΩ at 1A, 2V	50mΩ at 1A, 2V	50mΩ at 1A, 2V
Insulation Resistance:	>10 <sup>9</sup> MΩ @ 500Vdc	>10 <sup>9</sup> MΩ @ 500Vdc	>10 <sup>9</sup> MΩ @ 500Vdc
Dielectric Strength:	>2.0kVac	>2.0kVac	>2.0kVac
Operating Temp. Range:	-20°C to +55°C	-20°C to +55°C	-20°C to +55°C
Operations			
Mechanical:	1,000,000 (min)	1,000,000 (min)	1,000,000 (min)
Electrical:	100,000 (min)	100,000 (min)	100,000 (min)
Rear Nut Fixing Torque:	12Nm	12Nm	12Nm
Materials			
Mouldings:	Nylon	Nylon	Nylon
Tags/Terminations:	Brass, Silver Plated	Brass, Silver Plated	Brass, Silver Plated
Switch Body & Button:	Stainless Steel (Polished)	Stainless Steel (Polished)	Stainless Steel (Polished)
Contacts:	Silver	Silver	Silver
Thread size:	Gold Plated Brass version available	Gold Plated Brass version available	Gold Plated Brass version available
Sealing:	IP65	IP65	IP65
Impact Rating:	IK08	IK08	IK08
RoHS	Compliant	Compliant	Compliant

Low Profile



MP0045/1D

- 18mm bezel diameter
- 16mm fixing hole diameter
- D.P.C.O
- 250V ac

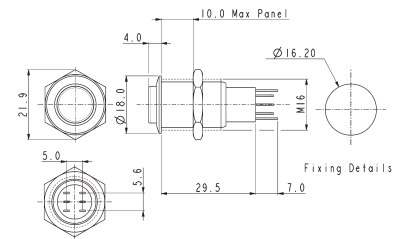

Prominent Button



MP0045/3D

- 18mm bezel diameter
- 16mm fixing hole diameter
- D.P.C.O
- 250V ac

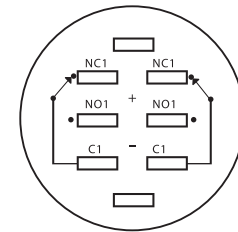
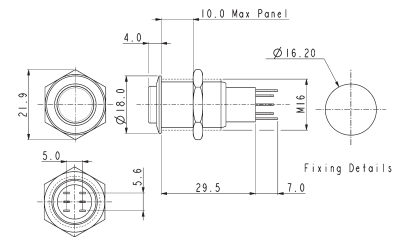

Contact Layout

Specifications	MP0045/1D0NN000	MP0045/3D0NN000
Terminations:	Solder tags	Solder tags
Switching:	D.P.C.O Momentary Action	D.P.C.O Momentary Action
Max. Rating:	250V ac	250V ac
Contact Resistance:	50mΩ max. @ 1A, 2V	50mΩ max. @ 1A, 2V
Insulation Resistance:	>10 <sup>3</sup> MΩ @ 500Vdc	>10 <sup>3</sup> MΩ @ 500Vdc
Dielectric Strength:	> 2.0kVac	> 2.0kVac
Operating Temp. Range:	-20°C to +55°C	-20°C to +55°C
Operations		
Mechanical:	200,000 (min)	200,000 (min)
Electrical:	30,000 (min)	30,000 (min)
Rear Nut Fixing Torque:	12Nm	12Nm
Materials		
Mouldings:	Nylon	Nylon
Tags/Terminations:	Brass, Silver Plated	Brass, Silver Plated
Switch Body & Button:	Stainless Steel	Stainless Steel
Contacts:	Silver	Silver
Variants:	Nickel Plated Brass version available Details on request	Nickel Plated Brass version available Details on request
RoHS	Compliant	Compliant

Low Profile



MP0045/1E

- 18mm bezel diameter
- 16mm fixing hole diameter
- D.P.C.O.
- 250V ac

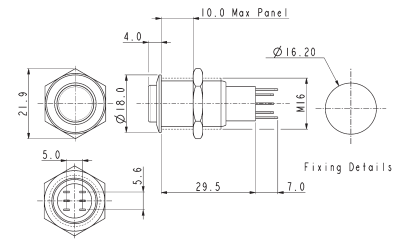

Prominent Button



MP0045/3E

- 18mm bezel diameter
- 16mm fixing hole diameter
- D.P.C.O.
- 250V ac

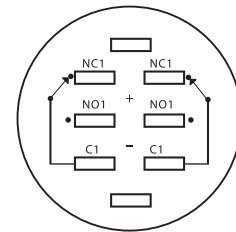
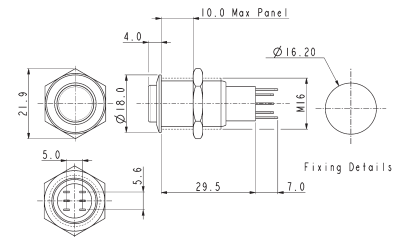

Contact Layout

Specifications	MP0045/1E0NN000	MP0045/3E0NN000
Terminations:	Solder Tags	Solder Tags
Switching:	D.P.C.O. - Latching Action	D.P.C.O. - Latching Action
Max. Rating:	250V ac	250V ac
Contact Resistance:	50mΩ max. @ 1A, 2V	50mΩ max. @ 1A, 2V
Insulation Resistance:	>10 <sup>3</sup> MΩ @ 500Vdc	>10 <sup>3</sup> MΩ @ 500Vdc
Dielectric Strength:	>2.0kVac	>2.0kVac
Operating Temp. Range:	-20°C to +55°C	-20°C to +55°C
Operations		
Mechanical:	200,000 (min)	200,000 (min)
Electrical:	30,000 (min)	30,000 (min)
Rear Nut Fixing Torque:	12Nm	12Nm
Materials		
Mouldings:	Nylon	Nylon
Tags/Terminations:	Brass, Tin Plated	Brass, Tin Plated
Switch Body & Button:	Stainless Steel (Polished)	Stainless Steel (Polished)
Contacts:	Silver	Silver
Thread size:	Nickel Plated Brass version Details on request	Nickel Plated Brass version Details on request
RoHS	Compliant	Compliant

## Front Panel Mounting



MP0045/1D1

- Dot Illuminated
- 18mm bezel diameter
- D.P.C.O.
- 3A, 250V ac
- Red, Green, Amber or Blue Illumination
- Separate LED Terminals

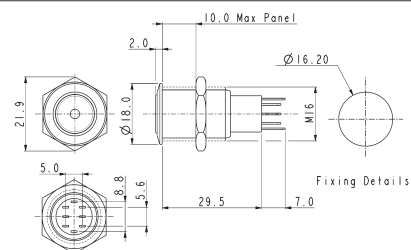

## Front Panel Mounting



MP0045/1D2

- Ring Illuminated
- 18mm bezel diameter
- D.P.C.O.
- 3A, 250V ac
- Red, Green, Amber or Blue Illumination
- Separate LED Terminals

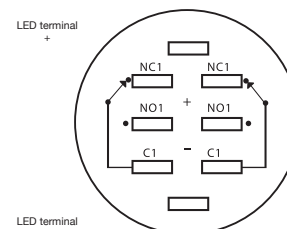
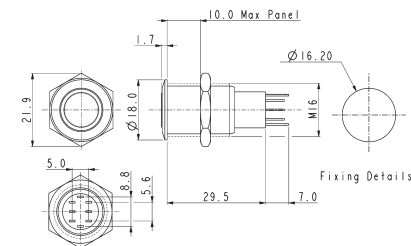

Contact Layout

Specifications	MP0045/1D1/Colour/Voltage	MP0045/1D2/Colour/Voltage
Terminations:	Solder Tags	Solder Tags
Illumination:	Dot	Ring
Switching:	D.P.C.O. Momentary Action	D.P.C.O. Momentary Action
Max. Switch Rating:	3A, 250Vac	3A, 250Vac
LEDs		
Colours	Red    Green    Amber    Blue	Red    Green    Amber    Blue
Part No.	/RD    /GN    /AM    /BL	/RD    /GN    /AM    /BL
Voltage	12Vdc    220Vdc	12Vdc    220Vdc
Part No.	/012    /220	/012    /220
Contact Resistance:	50mΩ max. @ 1A, 2Vdc	50mΩ max. @ 1A, 2Vdc
Insulation Resistance:	>10 <sup>3</sup> MΩ @ 500Vac	>10 <sup>3</sup> MΩ @ 500Vac
Dielectric Strength:	>2.0kVac	>2.0kVac
Operating Temp. Range:	-20°C to +55°C	-20°C to +55°C
Operations		
Mechanical:	200,000 (min)	200,000 (min)
Electrical:	30,000 (min)	30,000 (min)
Rear Nut Fixing Torque:	12Nm	12Nm
Materials		
Mouldings:	Nylon	Nylon
Tags:	Brass, Silver Plated	Brass, Silver Plated
Switch Body & Button:	Stainless Steel (Polished)	Stainless Steel (Polished)
Variants	Prominent Button, details on request	Prominent Button, details on request
<b>RoHS</b>	Compliant	Compliant

## Front Panel Mounting



MP0045/1E1

- Dot Illuminated
- 18mm bezel diameter
- D.P.C.O.
- 3A, 250V ac
- Red, Green, Amber or Blue Illumination
- Separate LED Terminals

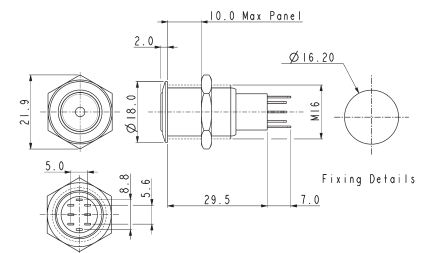

## Front Panel Mounting



MP0045/1E2

- Ring Illuminated
- 18mm bezel diameter
- D.P.C.O.
- 3A, 250V ac
- Red, Green, Amber or Blue Illumination
- Separate LED Terminals

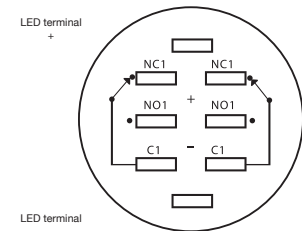
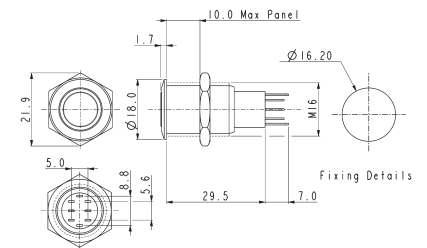

Contact Layout

Specifications	MP0045/1E1/Colour/Voltage	MP0045/1E2/Colour/Voltage
Terminations:	Solder Tags	Solder Tags
Illumination:	Ring	Ring
Switching:	D.P.C.O. Momentary Action	D.P.C.O. Momentary Action
Max. Switch Rating:	3A, 250Vac	3A, 250Vac
LEDs		
Colours	Red    Green    Amber    Blue	Red    Green    Amber    Blue
Part No.	/RD    /GN    /AM    /BL	/RD    /GN    /AM    /BL
Voltage	12Vdc    220Vdc	12Vdc    220Vdc
Part No.	/012    /220	/012    /220
Contact Resistance:	50mΩ max. @ 1A, 2Vdc	50mΩ max. @ 1A, 2Vdc
Insulation Resistance:	>10 <sup>3</sup> MΩ @ 500Vac	>10 <sup>3</sup> MΩ @ 500Vac
Dielectric Strength:	>2.0kVac	>2.0kVac
Operating Temp. Range:	-20°C to +55°C	-20°C to +55°C
Operations		
Mechanical:	200,000 (min)	200,000 (min)
Electrical:	30,000 (min)	30,000 (min)
Rear Nut Fixing Torque:	12Nm	12Nm
Materials		
Mouldings:	Nylon	Nylon
Tags:	Brass, Silver Plated	Brass, Silver Plated
Switch Body & Button:	Stainless Steel (Polished)	Stainless Steel (Polished)
Variants	Prominent Button, details on request	Prominent Button, details on request
<b>RoHS</b>	Compliant	Compliant



# Switches 8300 Vandal Resistant Switches

Designed to IP66



H8300RP - - -

## Key Features

- Momentary or latching action
- Ratings up to 12(12) @ 250Vac
- Single and double pole
- Stainless steel button & bezel
- Vandal resistant construction
- Choice of body styles
- 19.2mm or 22.5mm mounting holes
- Front panel sealed to IP66
- Raised, flat or domed actuator options

## Approvals and specifications

16(4)A 250Vac T85, 1E4 (10,000 Operations)  
 12(12)A 250Vac T105, 1E4 (10,000 Operations)  
 8(8)A 250Vac T105, 5E4 (50,000 Operations)  
 6(6)A 250Vac T125, 5E4 (50,000 Operations)

12A 250Vac DP, 13A 250Vac SP  
 250Vac 1hp, 125Vac 1/2hp  
 UL 85°C, file E45221, CSA file LR10990

In house test:  
10(10)A 250Vac—Indicative rating only

3mm contact gap.  
Technical data on pages 4 & 5 (switches),  
6 (indicators).

## Dimensions

8300RP (H terminals shown)

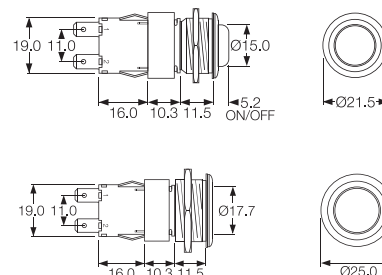

Terminal	Function	Actuator	Body Code
<b>C</b>  <b>H</b> 	<b>8300</b> (alternate) Single pole ON - OFF 	<b>R</b> (for P body only) Raised top (stainless steel) 	
<b>K</b>  <b>T</b> 	<b>8301</b> (momentary ON) Single pole ON - OFF 	<b>V</b> Flat top (stainless steel) 	<b>P</b> (for R actuator only) Stainless steel, Soft profile bezel 
<b>V</b>  <b>X</b> 	<b>8301</b> (momentary ON) Single pole ON - OFF 	<b>P</b> Domed top (stainless steel) 	<b>M</b> Stainless steel 

Switches  
**0911 Vandal Resistant Switches**

Designed to IP66



C0911VA - - -

**Key Features**

- Snap action switches
- Ratings up to 16A, 250Vac
- Round and rectangular buttons
- Single Pole C/O Switch

**Approvals and specifications**

- ⚡ 16(4)A 250Vac 5E4 T85
- UL Ⓢ 16A 125/250Vac 3/4hp T85 50E3  
 125V 1/2 HP, 250V 3/4 HP, 0.4A 125Vdc, 0.2A 250Vdc

Approvals apply to switch mechanism only.  
 μ contact gap.

**Dimensions**

C0911VA

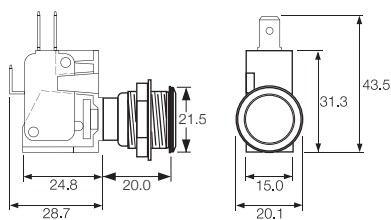

Terminal	Function	Actuator	Body Code
	<p><b>0911</b>                      (momentary)                      ON - ON</p>	<p><b>V</b> Flat top (stainless steel)</p>	<p><b>A</b></p> <p>Stainless steel                      Chamfer profile bezel</p> <p>Panel cut-out                      Panel thickness up to 8.0mm</p>

Bulgin's broad line of pushbutton switches are available in various sizes and configurations. This includes a variety of illumination and terminal options as well as several with high inductive power ratings suitable for motor driven applications. These switches can be found in many markets including home appliances, commercial, medical, audio and security.

- Miniature, round and rectangular push button switches available
- Ratings up to 16A, 250V ac  
12(12)A 250V ac rating also available
- Latching and momentary actions
- Choice of actuators  
(custom option also available)
- Square and Round Mounting Styles



Front Panel Mounting



MP0012/Col

- 22mm diameter
- Prominent Button
- S.P. Push to Make
- Screw Terminals
- Brass, Chrome Plated Body, Glass Filled Nylon Button

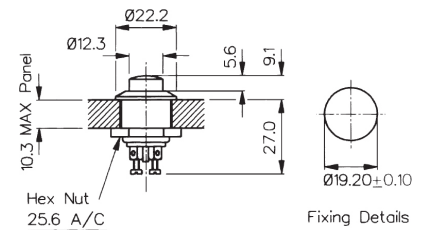

Front Panel Mounting



MP0012/1/Col

- 22mm diameter
- Recessed Button
- S.P. Push to Make
- Screw Terminals
- Brass, Chrome Plated Body, Glass Filled Nylon Button

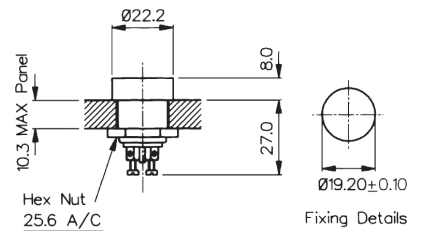

Rear Panel Mounting



MP0016

- S.P. Push to Make
- Solder Tags
- 1A, 28Vac/dc
- Brass Nickel Plated Body, Glass Filled Nylon Button

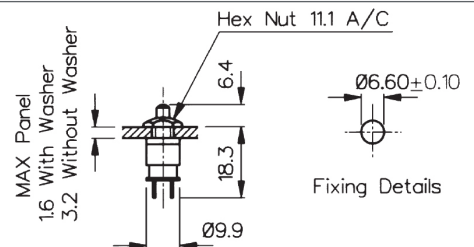

Specifications	MP0012/Colour	MP0012/1/Colour	MP0016/Colour
Terminations:	Screw Terminals	Screw Terminals	Solder Tags
Switching:	S.P. Push to Make Slow Momentary Action	S.P. Push to Make Slow Momentary Action	S.P. Push to Make Slow Momentary Action
Max. Rating:	0.25A. 250Vac, 1A. 110Vac, 2A. 12Vac/dc	0.25A. 250Vac, 1A. 110Vac, 2A. 12Vac/dc	1A 28Vac/dc (non-inductive)
Contact Resistance:	<15mΩ	<15mΩ	<15mΩ
Insulation Resistance:	>10 <sup>4</sup> MΩ	>10 <sup>4</sup> MΩ	>10 <sup>4</sup> MΩ
Dielectric Strength:	>2.5kVac	>2.5kVac	>2.0kVac
Operating Temp. Range:	-20°C to +85°C	-20°C to +85°C	-20°C to +85°C
Operation Pressure (typ):	9.18 newtons	9.18 newtons	6.22 newtons
Materials			
Moulding:	Glass Filled Nylon Brass,	Glass Filled Nylon Brass,	Glass Filled Nylon Brass,
Body:	Brass, Chrome Plated	Brass, Chrome Plated	Brass, Chrome Plated
Contacts/Terms:	Brass, Silver Plated	Brass, Silver Plated	Brass, Silver Plated
Variant	Button Colour: Standard - Black, /RD (Red)	Button Colour: Standard - Black, /RD (Red)	Button Colour: Standard - Black, /RD (Red)
RoHS	Compliant	Compliant	Compliant

Front Panel Mounting

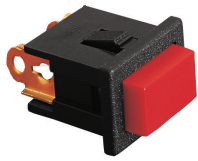

MP0022/Col

- S.P. Push to Make
- Solder Tags
- Nylon Body & Button

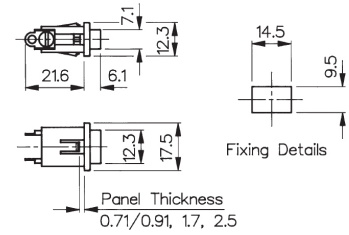

Switch Contact Operation



S.P. Push to Make S.P.M.B.

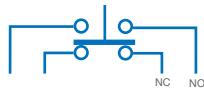

S.P.C.O.



D.P.C.O.



D.P.M.B.

**Specifications** **MP0022/Colour**

Terminations:	Solder Tags
Switching:	S.P. Push to Make Slow Momentary Action
Max. Rating:	0.25A. 250Vac, 0.5A. 110Vac, 1A. 0.1 to 28Vac/dc
Contact Resistance:	<15mΩ
Insulation Resistance:	>10 <sup>4</sup> MΩ
Dielectric Strength:	>2.5kVac
Operating Temp. Range:	-20°C to +70°C
Sealing:	
Materials	
Moulding:	Nylon
Tags:	Brass, Silver Plated
Body:	Nylon
Contacts/Terms:	Brass, Silver Plated
Variant	Button Colours: Standard - Black, /WH (White) and /RD (Red). /TERM - (Screw terminals)

**RoHS** Compliant

# 8300 Series Push Button

8(8)A 250Vac & 12(12)A 250Vac



## Key Features

- Miniature push button
- 8A Inductive current rating
- Ratings up to 12(12)A, 250V ac (H suffix)
- Illuminated and nonilluminated
- Single and double pole
- Latching and momentary
- Slotted actuator for custom buttons
- Industry standard panel cutout
- BioCote antimicrobial option
- Panel cut out: 19.3 x 12.9

## Approvals and specifications

16(4)A 250Vac T85, 1E4 (10,000 Operations)  
 12(12)A 250Vac T105, 1E4 (10,000 Operations)  
 8(8)A 250Vac T105, 5E4 (50,000 Operations)  
 6(6)A 250Vac T125, 5E4 (50,000 Operations)

8350, 8351, 8353, 8354  
 12A 250Vac DR, 250Vac 1hp, 125Vac 1/2hp

8300, 8301, 8303, 8304  
 13A 250Vac SP, 250Vac 1hp, 125Vac 1/2hp

UL 85°C, file E45221, CSA file LR10990

In house test:  
10(10)A 250Vac—Indicative rating only

BioCote antimicrobial additive. Independently verified to ISO22196:2007.

3mm contact gap.

Terminal	Function	Actuator	Body Code	Body Colour								
<b>C</b>  6.3 x 0.8 10.1	 Approvals & ratings vary with function Single pole switches use terminals 1 & 2 (& 3)	<b>A</b> Standard actuator  <b>H</b> Slotted for custom caps  Slots for snap-in buttons 	Panel cut-out ** Bezel <b>B</b> Standard body  <b>E</b> Softline style body with radiused bezel  Cut-outs must be punched in the direction of insertion  <b>Dimensions for snap-in fixing</b> <table border="1"> <tr> <th>Panel thickness</th> <th>Dimension X</th> </tr> <tr> <td>0.75-1.24</td> <td>19.1/19.2</td> </tr> <tr> <td>1.25-1.99</td> <td>19.3/19.4</td> </tr> <tr> <td>2.00-3.00</td> <td>19.7/19.8</td> </tr> </table>	Panel thickness	Dimension X	0.75-1.24	19.1/19.2	1.25-1.99	19.3/19.4	2.00-3.00	19.7/19.8	<b>B</b> Black  <b>W</b> White
Panel thickness	Dimension X											
0.75-1.24	19.1/19.2											
1.25-1.99	19.3/19.4											
2.00-3.00	19.7/19.8											
<b>H</b>  4.8 x 0.8 8.5 <b>A</b>  7.6 As "H" but right angle 4.8 x 0.8	<b>8300</b> Single Pole ON - OFF  <b>8301</b> Single Pole ON - OFF (momentary ON)  <b>8303</b> Single Pole ON - OFF With Light  <b>8304</b> Single Pole ON - OFF (momentary ON) with light 	<b>C</b> Square actuator  <b>E</b> Radiused actuator  <b>F</b> Small round actuator  <b>J</b> Smooth curved actuator  <b>M</b>  <b>D</b> Large round actuator  All actuators except H available lit	X and V PCB terminals. Additional dummy terminals may be supplied for extra support.									
<b>K</b>  2.8 x 0.8 8.5 2.6 1.5	<b>8350</b> Double pole ON - OFF  <b>8351</b> Double pole ON - OFF (momentary ON)  <b>8353</b> Double pole ON - OFF With light 											
<b>T</b>  2.8 x 0.8 7.0 2.6 1.5 Solder	<b>8354</b> Double pole ON - OFF (momentary ON) with light 											
<b>X</b>  PCB 0.8 Sq 7.0 4.5	<b>8355</b> Single pole ON - OFF Isolated light - switched C, E & M actuators only  <b>8356</b> Single pole ON - OFF Isolated light - unswitched C, E & M actuators only 											
<b>V</b>  Dual pin PCB (Call sales for mounting dims) 4.3 3.7 Ctrs												

## Dimensions

Actuator A  
Body B

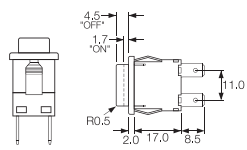

Actuator J  
Body E

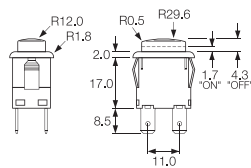

## Examples



☐ H8350AB ---  
☐ T8350AB ---



☐ H8353JE ---  
☐ T8353JE ---



☐ H8353EB ---  
☐ T8353EB ---



☐ H8353CB ---  
☐ T8353CB ---

Actuator Colour	Lamp Voltage	Legend	Legend Colour	Options	Biocote
LIT					
<b>A</b> Amber	— None			<p><b>H</b> 12(12)A 250Vac switch rating</p> <p><b>Finish</b> Matt finish standard except on J and D actuators which are gloss</p> <p><b>Colour</b> Call sales for custom colours A full range is available for large orders</p> <p><b>Legend printing</b> Select from the examples or call sales for custom legends.</p> <p><b>Special buttons</b> Some of the many options are shown Call sales for the full range</p> <p><b>L167 Protective cover</b></p>  <p>Snaps on to switch bodies fitted with "A" or "J" style actuators, this reduces panel thickness by 0.8mm</p> <p><b>BioCote Antimicrobial Additive</b> Moulded components have antimicrobial properties using BioCote silver ion technology.</p>	<b>B</b> Biocote
<b>C</b> Clear	<b>2</b> 125V Neon				
<b>G</b> Green	<b>3</b> 250V Neon				
<b>R</b> Red	<b>7</b> 12V Filament				
UNLIT	<b>8</b> 24V Filament				
<b>B</b> Black					
<b>R</b> Red					
<b>W</b> White					

# 8200 Series Push Button

8(8)A 250Vac & 12(12)A 250Vac

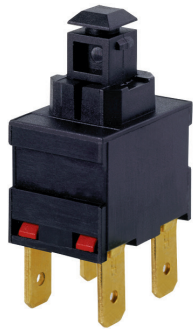

## Key Features

- ⬡ Miniature push button
- ⬡ 8A Inductive current rating
- ⬡ Ratings up to 12(12)A, 250V ac (H suffix)
- ⬡ Without button
- ⬡ Sub panel mount
- ⬡ Push on, solder or PCB terminals
- ⬡ Latching and momentary

## Approvals and specifications

- ⚡ 16(4)A 250Vac T85, 1E4 (10,000 Operations)
- 12(12)A 250Vac T105, 1E4 (10,000 Operations)
- 8(8)A 250Vac T105, 5E4 (50,000 Operations)
- 6(6)A 250Vac T125, 5E4 (50,000 Operations)

12A 250Vac  
250Vac 1hp, 125Vac 1/2hp  
UL 85°C, file E45221, CSA file LR10990

3mm contact gap.

Terminal	Function	Actuator	Body Code
<p><b>C</b></p> <p>6.3 x 0.8 10.1</p>	<p>1 2 3 4</p> <p>Approvals &amp; ratings vary with function Single pole switches use terminals 1 &amp; 2 (&amp; 3)</p> <p><b>8200</b> Single Pole ON - OFF</p>	<p><b>A</b></p> <p>Standard actuator for snap-on custom adaptors</p> <p>8.0</p>	<p><b>A</b></p> <p>Standard body</p>
<p><b>H</b></p> <p>4.8 x 0.8 8.5</p> <p><b>A</b></p> <p>7.6 As "H" but right angle 4.8 x 0.8</p>	<p><b>8201</b> Single Pole ON - OFF (momentary ON)</p>	<p><b>B</b></p> <p>Flat top actuator</p> <p>5.5</p>	<p>See dimensioned drawings for details</p>
<p><b>K</b></p> <p>2.8 x 0.8 8.5 2.6 1.5</p>	<p><b>8250</b> Double Pole ON - OFF</p>	<p><b>C</b></p> <p>Curved top actuator</p> <p>8.0</p> <p>Examples of possible actuation methods Using a Snap on adaptor</p>	<p><b>C</b></p> <p>As standard body but with side support peg for use with M PCB terminals</p> <p>X and V PCB terminals. Additional dummy terminals may be supplied for extra support.</p>
<p><b>T</b></p> <p>2.6 1.5 7.0 Solder</p> <p><b>V</b></p> <p>3.7 Ctrs 4.3 Dual pin PCB (Call sales for mounting dims)</p>	<p><b>8251</b> Double Pole ON - OFF (momentary ON)</p>	<p>Using a Hinged Actuator</p>	
<p><b>X</b></p> <p>4.5 7.0 PCB 0.8 Sq</p>			



## Dimensions

'A' body with 'H' 4.8 terminals

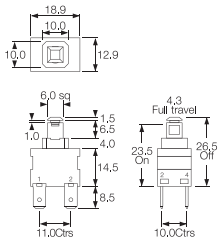

Example of possible mounting styles

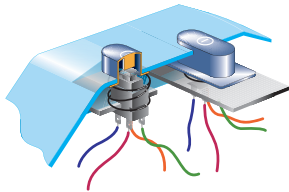

'A' body with 'A' right angle 4.8 terminals

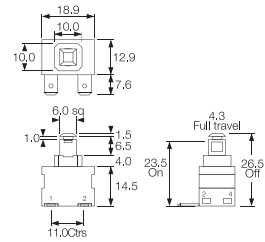

Alternative Actuator

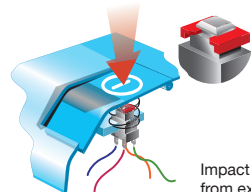

Impact washer resists damage from excessive operator force

'C' body with 'M' right angle PCB terminals

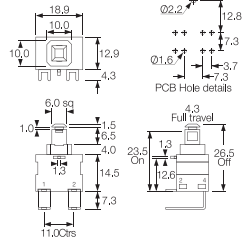

## Examples



C8250AA --- with impact washer M1226



X8201AA ---



K8200AA ---



A8200AA ---



M8200AC ---



Example of M8200AC

# 7000 Series Push Button

16A 250Vac



## Key Features

- Round and rectangular push button switches
- Ratings up to 16A, 250V ac
- Latching and momentary
- Illuminated & non-illuminated
- Matching indicators
- Low profile version
- Panel cut outs: 25.0 dia 27.2 x 22.3

## Approvals and specifications

- CE 16(4)A 250Vac T125  
8(8)A 250Vac T85
- UL CSA 16A Non Ind, 250Vac 1hp, 125Vac 1/2hp  
UL 65°C, file no. E45221, CSA file no. LR10990  
3mm contact gap.

Terminal	Function	Actuator	Body Code
<p><b>C</b></p>	<p>1 2 3 4 Approvals &amp; ratings vary with function Single pole switches use terminals 1 &amp; 2 (&amp; 3)</p> <p><b>7000</b> Single Pole ON - OFF</p> <p><b>7001</b> Single Pole (momentary) ON - OFF</p> <p><b>7003</b> Single Pole (with light) ON - OFF</p> <p><b>7004</b> Single Pole (momentary) with light ON - OFF</p>	<p><b>A</b> Round actuator shown in F body</p> <p><b>A</b> Round actuator shown in G body</p> <p><b>B</b> Round actuator - medium shown in F body</p> <p><b>C</b> Round actuator - long shown in F body</p> <p><b>D</b> Round actuator - sub panel mount</p> <p><b>S</b> Rectangular actuator Shown in "A" body N/A for 7030</p>	<p>Panel cut-outs</p> <p><b>F H G</b> Body types fit either cut-out</p> <p><b>A</b></p> <p>Cut-outs must be punched in the direction of insertion</p>
<p><b>H</b></p>	<p><b>7050</b> Double Pole ON - OFF</p> <p><b>7051</b> Double Pole with light ON - OFF</p> <p><b>7053</b> Double pole with light ON - OFF</p> <p><b>7054</b> Double pole (momentary ON) with light ON - OFF</p> <p><b>7030</b> Indicator UL E63363 CSA LR29381</p>	<p><b>4</b></p> <p><b>2</b></p> <p><b>4</b></p> <p><b>2</b></p> <p><b>4</b></p> <p><b>2</b></p>	

## Dimensions

Panel thickness:  
**A** - 0.8 - 2.5mm  
**F, G, H** - 0.8 - 5.0mm

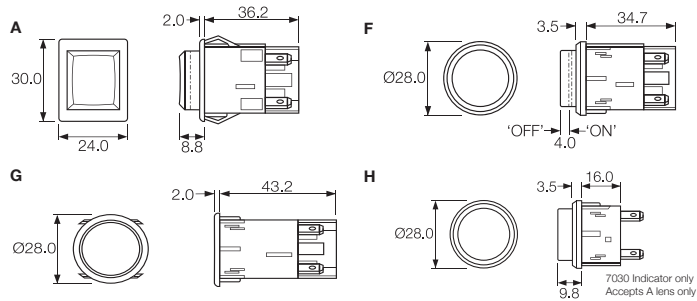

## Examples



C7000AF ---



C7003AF ---



C7050SA ---



C7053AG ---

Body Colour	Actuator Colour	Lamp Voltage	Legend	Legend Colour	Options
<b>B</b> Black	LIT <b>A</b> Amber	— None			<p><b>Finish</b> Matt finish is standard on bodies. Gloss finish is standard on actuators.</p> <p><b>Colour</b> Call sales for custom colours. A full range is available for large orders.</p> <p><b>Legend printing</b> A wide range is available or call sales for custom legends.</p> <p><b>Lamp voltage</b> Call sales for details of available voltages.</p> <p><b>Weatherproof housing (E)</b> Additional housing which fits round body switches with an oversize housing with a clear silicone cover designed to IP65. Mounting hole dia: 38.0mm</p>
<b>W</b> White	<b>C</b> Clear	<b>2</b> 125V Neon			
	<b>G</b> Green	<b>3</b> 250V Neon			
	<b>R</b> Red	<b>7</b> 12V Filament			
		<b>8</b> 24V Filament			
	UNLIT				
	<b>B</b> Black				
	<b>R</b> Red				
	<b>W</b> White				

# 0911 Push Button Switches

0.5A 250Vac

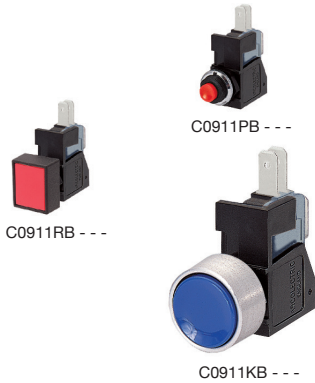

## Key Features

- Snap action switches
- Ratings up to 16A, 250Vac
- Round and rectangular buttons

## Approvals and specifications

16(4)A 250Vac 5E4 T85

16A 125/250Vac 3/4hp T85 50E3  
125V 1/2 HP, 250V 3/4 HP, 0.4A 125Vdc, 0.2A 250Vdc

Approvals apply to switch mechanism only.  
μ contact gap.

## Dimensions

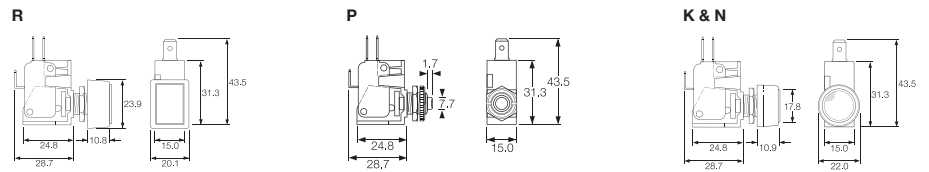

Terminal	Function	Actuator	Body Code	Options
	<p><b>0911</b> (momentary) ON - ON</p>	<p><b>R</b> Rectangular bezel</p> <p><b>P</b> Short</p> <p><b>K</b> with satin chrome bezel</p> <p><b>N</b> with nylon bezel</p>	<p>Panel Cut-out</p> <p>Panel thickness Both nuts 2.5mm No backnut 4.0mm</p>	<p>Call factory for custom colours</p>

# 0916 - 0920 Push Button Switches

0.5A 250Vac



## Key Features

- Self wiping contacts
- Slow make & break
- Momentary action
- Choice of switch circuits
- Choice of actuators

## Approvals and specifications

In house test:  
0.5A 250Vac T85 – Indicative rating only

## Dimensions

Dimensions (mm) Nylon S and L actuators

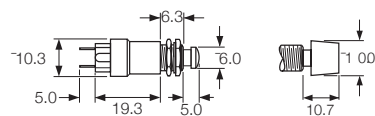

Neck thread - 40 TPI Whit. Actuator travel - 2.5 max

Stainless steel V actuator (IP66)

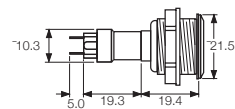

Neck thread - 26 TPI Whit. Actuator travel - 2.5 max

Terminal	Function	Actuator	Body Code	Options
<p><b>T</b></p> <p>Solder</p>	<p><b>0916</b></p> <p>Black base SP ON - OFF (momentary)</p>	<p><b>S</b> Small Actuator</p>	<p>7.1</p> <p>Panel Cut-out (L &amp; S Actuators)</p>	<p>Finish</p> <p>Gloss finish for L and S actuators.</p>
	<p><b>0917</b> 50V only</p> <p>Brown base SP ON - OFF (momentary 1 side)</p>	<p><b>L</b> Large Actuator</p>	<p>Panel thickness Both nuts - 2.5mm No Backnut - 4.0</p>	<p>Colour</p> <p>Call sales for custom colours. A full range is available for large orders.</p>
	<p><b>0918</b></p> <p>White base SP ON - OFF (momentary OFF)</p>	<p><b>V</b> Vandal Resistant IP66 Flattop Stainless Steel</p>	<p>19.2</p> <p>Panel Cut-out (Stainless Steel V Actuator) Panel thickness - 8.0mm</p>	
	<p><b>0919</b></p> <p>Black base DP ON - OFF (momentary 1 side)</p>			
	<p><b>0920</b></p> <p>White base DP ON - OFF (momentary ON)</p>			

120/140V Voltage Selector



VS0001

- 2.8 series tabs/solder tags
- Square Front Bezel
- 6.3A
- CSA & VDE approvals

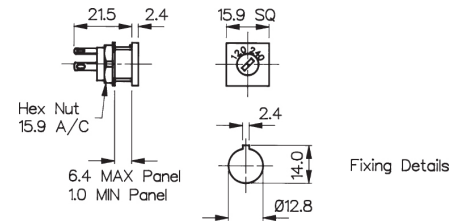

120/140V Voltage Selector



VS0002

- 2.8 series tabs/Solder tags
- Round Front Bezel
- 6.3A
- CSA & VDE approvals

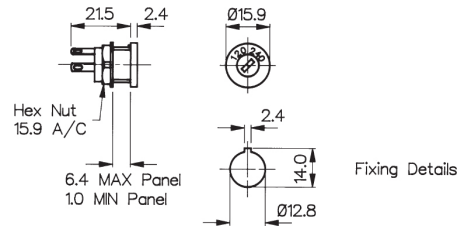

Connection Parallel 120V

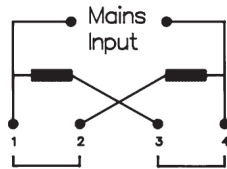

Connection Series 240V

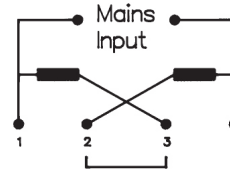

Specifications	VS0001	VS0002
Max. Rating:	6.3A, 120 / 240	6.3A, 120 / 240
Insulation Resistance:	>106 MΩ	>106 MΩ
Termination:	2.8 series tabs/solder tags	2.8 series tabs/solder tags
Temperature Range:	-20°C to +85°C	-20°C to +85°C
Materials:		
Mouldings:	Glass Filled Nylon UL94V-1	Glass Filled Nylon UL94V-1
Tags:	Brass, Silver Plated	Brass, Silver Plated
Contacts:	Copper Silver Alloy	Copper Silver Alloy
Approvals:		
Variants:	Other markings, details on request	Other markings, details on request
	<b>RoHS</b>	Compliant

Unlike traditional switches **Piezo** switches have **no moving mechanical parts** making them **extremely durable**, withstanding millions of actuations and requiring little to no maintenance.



Piezo Switches  
**16mm Stainless Steel**

Non Illuminated



16MM Stainless Steel Non Illuminated



MPZ016

- Non Illuminated
- 20 cm lead
- Flathead or Guided profile

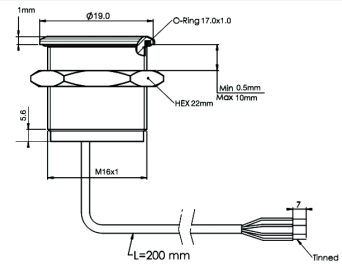

**Specification**

**MPZ016**

Type	Momentary
Material	Stainless Steel (Aluminium upon request)
Maximum Voltage	24V AC/DC
Switch Resistance "ON"	<1Ω
Switch Resistance "OFF"	5MΩ
Capacitance	100pF
Switching current (momentary)	1A Max
Switching current (prolonged)	300 mA
Switching pulse time (momentary)	up to 0.3 sec
Actuating force, typically	3-5 N
Life cycle	>10 Million

**Environmental Specification**

Sealing	IP68; IP69K
Operating temperature	-40°C to +85°C
Vibration resistance	5-500Hz/9.4m
Shock resistance	75g (g-force)
<b>RoHS</b>	Compliant

**Circuit Specification**

16MM Stainless Steel Non Illuminated

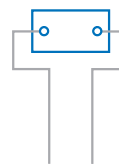

Switch voltage	24V AC/DC
Switch Current	1A Max
Power Supply	24V AC/DC



# Piezo Switches 19mm Stainless Steel

Illuminated and Non Illuminated



## 19MM Stainless Steel Illuminated



MPZI019

- Blue Illumination
- 20 cm lead
- Flathead

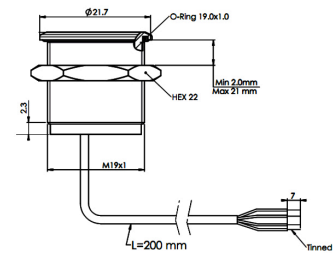

## 19MM Stainless Steel Non Illuminated



MPZ019

- Non Illumination
- 20 cm lead
- Flathead

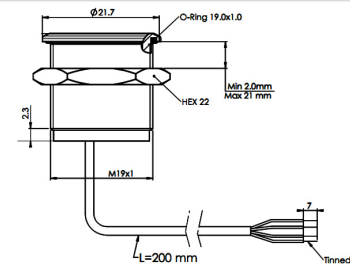

### Specification

### MPZ019, MPZI019

Type	Momentary
Material	Stainless Steel (Aluminium upon request)
Maximum Voltage	24V AC/DC
Switch Resistance "ON"	<1Ω
Switch Resistance "OFF"	5MΩ
Capacitance	100pF
Switching current (momentary)	1A Max
Switching current (prolonged)	300 mA
Switching pulse time (momentary)	up to 0.3 sec
LED Illumination	24V AC/DC
Actuating force, typically	3-5 N
Life cycle	>10 Million

### Environmental Specification

Sealing	IP68; IP69K
Operating temperature	-40°C to +85°C
Vibration Resistances	5-500Hz/9.4m
Shock resistance	75g (g-force)
<b>RoHS</b>	Compliant

### Circuit Specification

#### 19MM Stainless Steel Non Illuminated

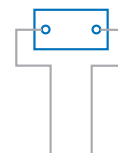

Switch voltage	24V AC/DC
Switch Current	1A Max
Power Supply	24V AC/DC

#### 19MM Stainless Steel Illuminated

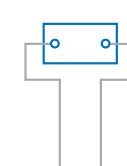

Switch voltage	24 V AC/DC
Switch Current	1A Max
Colour* Illuminated	24V AC/DC
Power Supply	24V AC/DC

# Piezo Switches 22mm Stainless Steel

Illuminated and Non Illuminated



## 22MM Stainless Steel Non Illuminated



MPZ022

- Non Illumination
- 20 cm lead
- Flathead

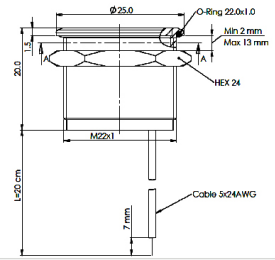

## 22MM Stainless Steel Illuminated



MPZI022

- Red or Green Illumination
- 1 colour
- 20 cm lead
- Flathead

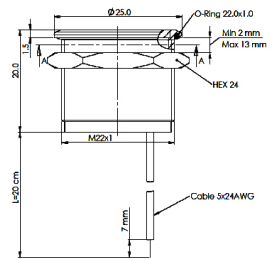

## 22MM Stainless Steel Illuminated



MPZI022

- Red and Green Illumination
- (2 colour)
- 20 cm lead
- Flathead

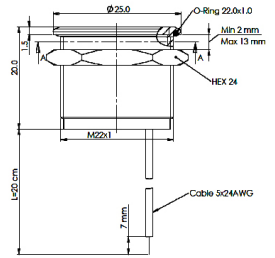

### Specification

### MPZ022, MPZI022

Type	Momentary
Material	Stainless Steel (Aluminium upon request)
Maximum Voltage	24V AC/DC
Switch Resistance "ON"	<1Ω
Switch Resistance "OFF"	5MΩ
Capacitance	100pF
Switching current (momentary)	1A Max
Switching current (prolonged)	300 mA
Switching pulse time (momentary)	up to 0.3 sec
LED Illumination	24V AC/DC
Actuating force, typically	3-5 N
Life cycle	>10 Million

### Environmental Specification

Sealing	IP68; IP69K
Operating temperature	-40°C to +85°C
Vibration Resistances	5-500Hz/9.4m
Shock resistance	75g (g-force)
<b>RoHS</b>	Compliant

### Circuit Specification

#### 22MM Stainless Steel Non Illuminated



Switch Voltage	24 AC/DC
Switch Current	1A Max
Power Supply	24V AC/DC

#### 22MM Stainless Steel Illuminated 1 colour

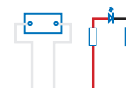

Switch Voltage	24V AC/DC
Switch Current	1A Max
Color* Illuminated	24V AC/DC
Power Supply	24 AC/DC

#### 22MM Stainless Steel Illuminated 2 colour

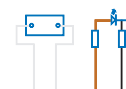

Switch Voltage	24V AC/DC
Switch Current	1A Max
Color* Illuminated	24V AC/DC
Power Supply	24 AC/DC

Piezo Switches  
**22mm Stainless Steel Flathead**

Illuminated



22MM Stainless Steel Illuminated



MPZI022/L

- Blue Illumination
- 1 colour
- 20 cm lead

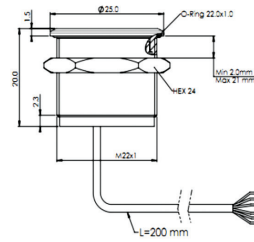

**Specification**

**MPZI022/L**

Type	Latching Toggle
Material	Stainless Steel (Aluminium upon request)
Power Supply	24V AC/DC
Switching voltage	48V AC peak/DC
Switch Resistance "ON"	<0.7Ω
Switch Resistance "OFF"	>1000MΩ
Capacitance	<90pF
Switching current	1A Max
LED Illumination	24V AC/DC
Actuating force, typically	3-5 N
Life cycle	>10 Million

**Environmental specification**

Sealing	IP68; IP69K
Operating temperature	-40°C to +85°C°
Vibration Resistances	5-500Hz/9.4m
Shock resistance	75g (g-force)
<b>RoHS</b>	Compliant

**Circuit Specification**

22MM Stainless Steel Latching Toggle Illuminated

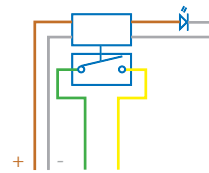

Power Supply	24V AC/DC
Switch Voltage	48V AC peak/ DC
Switch Current Max	1A Max
Colour* Illuminated	24V AC/DC

**Part No System**

<b>MPZ</b>	/	<b>016</b>	/	<b>X</b>	/	<b>XX</b>	/	<b>X</b>	/	<b>X</b>
<b>Series</b> MPZ - Non Illuminated MPZI- Illuminated		<b>Body Diameter</b> 016 = 16mm 019 = 19mm 022 = 22mm		<b>Profile</b> F = Flat Head G = Guided Profile		<b>Colour</b> BL = Blue RD = Red GN = Green D1 = Red and green		<b>Led Voltage</b> 24v		<b>Type</b> L = Latching Toggle (No Suffix= Momentary)

**Examples:**

MPZ022/F = Non Illuminated Piezo, 22mm, Flathead

MPZI022/F/RD/24 = Illuminated Piezo, 22mm, Flathead, Red Illumination, 24 volt

MPZI022/G/BL/24/L = Illuminated Piezo, 22mm, Guided Profile, Blue Illumination, 24 volt, Latching Toggle

**Circuit Specifications**

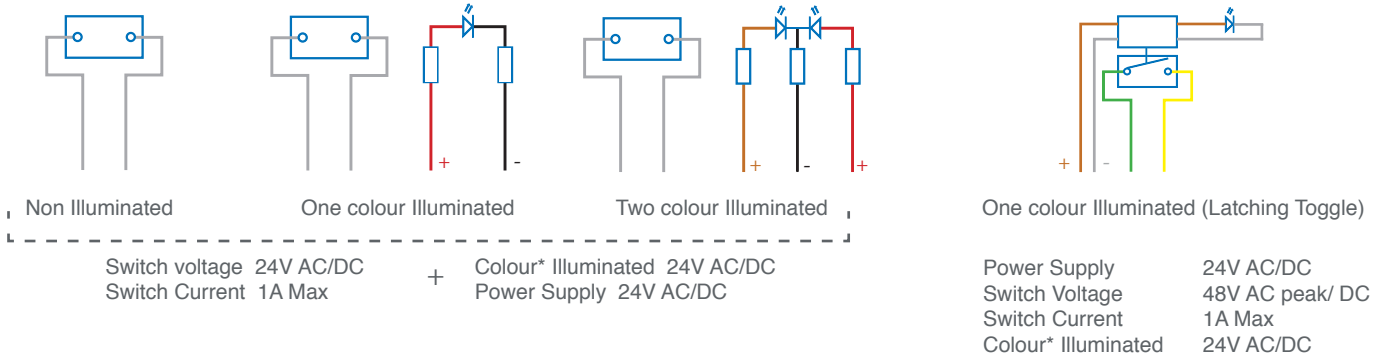

Other switches are available upon request\*

MAV0120



MAV0120

- Prominent and Flush Profile
- 12mm Diameter
- 2A, 36 dc
- IP67 (Front of Panel Only)

Prominent Profile

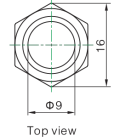
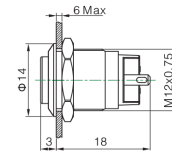

Flush Profile

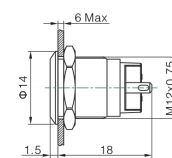

## Specification

### MAV0120/3

### MAV0120/1

Terminations:	P - Solder Tabs	P - Solder Tabs
Switching:	S.P. Push to make	S.P. Push to make
Max Rating:	2A, 36Vdc	2A, 36Vdc
Contact Resistance:	≥50MΩ	≥50MΩ
Insulation Resistance:	≥1000MΩ	≥1000MΩ
Dielectric Strength:	1500V, AC 50Hz, 5 Secs	1500V, AC 50Hz, 5 Secs
Operating Temp Range:	*-25°C ~ +55°C	*-25°C ~ +55°C
<b>Operations</b>		
Mechanical:	500,000 (min)	500,000 (min)
Electrical:	200,000 (min)	200,000 (min)
Sealing (Front of Panel Only)	IP67	IP67
Shock Resistance	IK08	IK08
Rear Nut Fixing Torque:	0.6Nm	0.6Nm
<b>Materials</b>		
Mouldings:	PA	PA
Tags/Terminations:	Copper, Gold Plated	Copper, Gold Plated
Switch Body & Button:	Stainless Steel	Stainless Steel
Contacts:	Silver Alloy	Silver Alloy
Thread size:	M12x0.75	M12x0.75
RoHS	Compliant	Compliant

MAV0120

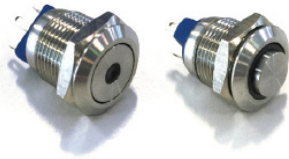

MAV0120

- Dot and Ring Illumination
- Prominent and Flush Profile
- 12mm Diameter
- 2A, 36 dc
- Bright daylight LEDs
- IP67 (Front of Panel Only)

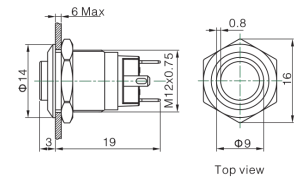
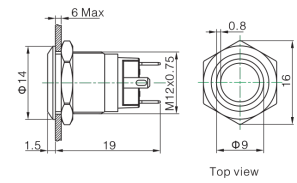
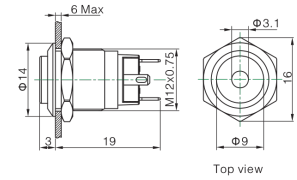
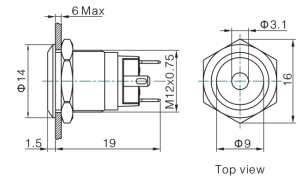

## Specification

## MAV0120

Terminations:	P - Solder Tabs				
Switching:	S.P. Push to make				
Max Rating:	2A, 36Vdc				
Profile:	Prominent /3 Flush /1				
Illumination Type	/1	Dot			
	/2	Ring			
LED Ratings					
Part No.					
Colours	/RD	/GN	/BL	/OR	/AM
Luminous Intensity	Red	Green	Blue	Orange	Yellow
Forward Voltage	1.8V	2.8V	2.8V	1.8V	1.8V
Forward Current					
Moulding Current	15mA	15mA	15mA	15mA	15mA
Illumination Voltage	/no suffix - No resistor fitted. An Appropriate resistor must be series connected by the user. Voltages as above				
	/12	12V			
	/24	24V			
Contact Resistance:	≥50MΩ				
Insulation Resistance:	≥1000MΩ				
Dielectric Strength:	1500V, AC 50Hz, 5 Secs				
Operating Temp. Range:	*-25°C ~ +55°C				
Operations					
Mechanical:	500,000 (min)				
Electrical:	200,000 (min)				
Sealing (Front of Panel Only)	IP67				
Shock Resistance	IK08				
Rear Nut Fixing Torque:	0.6Nm				
Materials					
Mouldings:	PA				
Tags/Terminations:	Copper, Gold Plated				
Switch Body & Button:	Stainless Steel				
Contacts:	Silver Alloy				
Thread size:	M12x0.75				
RoHS	Compliant				

MMP0120



MMP0120

- Raised Domed Profile
- 12mm Diameter
- 2A, 36Vac
- IP65 or IP67 (Front of Panel Only)

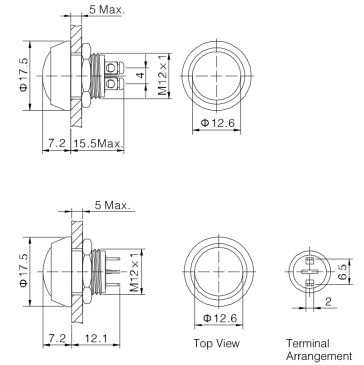

## Specification

### MMP0120/S

### MMP0120/N

Terminations:	P - Solder Tabs S - Screw Terminal	P - Solder Tabs S - Screw Terminal
Switching:	S.P. Push to make	S.P. Push to make
Max Rating:	2A, 36Vdc	2A, 36Vdc
Contact Resistance:	$\geq 50M\Omega$	$\geq 50M\Omega$
Insulation Resistance:	$\geq 1000M\Omega$	$\geq 1000M\Omega$
Dielectric Strength:	1500V, AC 50Hz, 5 Secs	1500V, AC 50Hz, 5 Secs
Operating Temp Range:	*-25°C ~ +55°C	*-25°C ~ +55°C
<b>Operations</b>		
Mechanical:	500,000 (min)	500,000 (min)
Electrical:	200,000 (min)	200,000 (min)
Sealing (Front of Panel Only)	IP65 or IP67	IP65 or IP67
Shock Resistance	IK08	IK08
Rear Nut Fixing Torque:	0.3Nm	0.3Nm
<b>Materials</b>		
Mouldings:	PBT	PBT
Tags/Terminations:	Brass, Silver Plated	Brass, Silver Plated
Switch Body & Button:	/SS Stainless Steel	/N - Nickel Plated Brass
Contacts:	Silver Alloy	Silver Alloy
Thread size:	M12x1	M12x1
RoHS	Compliant	Compliant

MMP0120/A



MMP0120/A

- Raised Domed Profile
- PBT Material
- 12mm Diameter
- 2A, 36Vac
- IP65 or IP67 (Front of Panel Only)

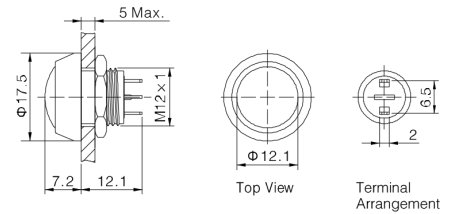
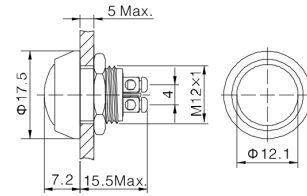

## Specification

## MMP0120/A

Terminations:	P - Solder Tabs
Switching:	S.P. Push to make
Max Rating:	2A, 36Vdc
Contact Resistance:	≥50MΩ
Insulation Resistance:	≥1000MΩ
Dielectric Strength:	1500V, AC 50Hz, 5 Secs
Operating Temp Range:	*-25°C ~ +55°C
<b>Operations</b>	
Mechanical:	1,000,000 (min)
Electrical:	200,000 (min)
Sealing (Front of Panel Only)	IP65 or IP67
Shock Resistance	IK08
Rear Nut Fixing Torque:	0.3Nm
<b>Materials</b>	
Mouldings:	PBT
Tags/Terminations:	Brass, Silver Plated
Switch Body	/A Black Anodised
Switch Button:	/NB Nickel Plated Brass /RD RED PBT /GN GREEN PBT /BL BLUE PBT /BK BLACK PBT
Contacts:	Silver Alloy
Thread size:	M12x1
RoHS	Compliant



MMPI0120



MMPI0120

- Raised Domed Profile
- Dot Illumination
- Bright daylight LEDs
- 12mm Diameter
- 2A, 36Vac
- IP65 (Front of Panel Only)

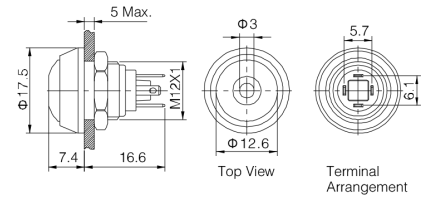

## Specification

## MMPI0120

Terminations:	P - Solder Tabs				
Switching:	S.P. Push to make				
Max Rating:	2A, 36Vdc				
LED Ratings					
Part No.	SS-RD	SS-GN	NN-RD	ABK-RD	AG-RD
Colours	Red	Green	Red	Red	Red
Luminous Intensity					
Forward Voltage	1.8V	2.8V	1.8V	1.8V	1.8V
Forward Current					
Moulding Current	15mA	15mA	15mA	15mA	15mA
Illumination Voltage	/no suffix - No resistor fitted. An Appropriate resistor must be series connected by the user. Voltages as above				
	/12				
Contact Resistance:	≥50MΩ				
Insulation Resistance:	≥1000MΩ				
Dielectric Strength:	1500V, AC 50Hz, 5 Secs				
Operating Temp. Range:	*-25°C ~ +55°C				
Operations					
Mechanical:	1,000,000 (min)				
Electrical:	200,000 (min)				
Sealing (Front of Panel Only)	IP65				
Shock Resistance	IK08				
Rear Nut Fixing Torque:	0.3Nm				
Materials					
Mouldings:	PBT				
Tags/Terminations:	Brass, Silver Plated				
Switch Body & Button:	Stainless Steel	Stainless Steel	Nickel Plated Brass	Black Anodized Body, Black PBT Button	Black Anodized Body, Green PBT Button
Contacts:	Silver Alloy				
Thread size:	M12x1				
RoHS	Compliant				

12mm Miniature Vandal Resistant Stainless Steel Switch

<b>MAV0120</b>	<b>X</b>	<b>X</b>	<b>X</b>	<b>X</b>	<b>X</b>
<b>Series</b> MAV0120	<b>Button</b> 1 = Flush 3 = Prominent	<b>Switching Type</b> D = Momentary	<b>Type of Illumination</b> Blank = None 1 = Dot 2 = Ring	<b>Illumination Colour</b> Blank = None RD = RED GN = GREEN BL = BLUE AM = AMBER/YELLOW OR = ORANGE	<b>Lamp Voltage</b> Blank = None 012 = 12V 024 = 24V

Examples:

MAV0120/3D = 12mm Prominent Actuator, Momentary, Non Illuminated  
 MAV0120/3D1BL024 = 12mm Prominent Actuator, Momentary, Blue Dot Illuminated, 24V  
 MAV0120/3D2GN012 = 12mm Prominent Actuator, Momentary, Green Ring Illuminated, 12V

12mm Miniature Metal/Plastic Domed Pushbutton Switch

<b>MMPXXX</b>	<b>X</b>	<b>X</b>	<b>X</b>	<b>X</b>	<b>X</b>	<b>X</b>
<b>Series</b> MMP0120 = Non Illuminated MMP10120 = Illuminated	<b>Body Material</b> S = Stainless Steel N = Nickel Plated Brass A = Black Anodized	<b>Button Material &amp; Colour</b> SS = Nickel Plated Brass RD = RED PBT GN = GREEN PBT BL = BLUE PBT BK = BLACK PBT	<b>Sealing</b> Blank = IP65 67 = IP67 IP67 (non-illuminated only)	<b>Illumination Colour</b> Blank = None RD = RED GN = GREEN BL = BLUE AM = AMBER/YELLOW OR = ORANGE	<b>Lamp Voltage</b> Blank = None 012 = 12V 024 = 24V Other voltages require external resistor	<b>Termination</b> S = Screw Terminals P = Solder Terminals (2.0mm x 0.5mm)

Examples:

MMP0120/SSSS = 12mm, Non Illuminated, All Stainless Steel, IP65, Screw Terminals  
 MMP0120/ARD67/S = 12mm, Non Illuminated, Black anodized body, Red PBT button, IP67, screw terminals  
 MMP10120/NNBRD012P = 12mm, Illuminated, All Nickel Plated Brass with 12V Red Dot illumination, IP65, Pin Terminals

This range of panel mounting indicators consists of **many different LED and Neon types**, bezel styles and colours. The range has developed to meet the many different needs of panel design including **IP66 environmentally sealed versions** for use where a front panel seal is needed.

- Available types: Ultra-thin, Miniature, Twin unit, Miniature round and Standard
- Rating from 10A, 250V ac up to 20A, 277V ac
- Single & double pole variants available
- Push-on, solder & PCB terminals
- Illuminated and non-illuminated options
- High in-rush (ON-OFF types)
- Matching Indicators
- Splash resistant options
- Choice of bezel styles and sizes, panel cut-outs and actuators
- Choice of switching circuits including 3 position



# 8800 Thinline Rocker Switches

10A 250Vac



## Key Features

- Ultra thin rocker switch
- Ratings up to 15A, 250Vac
- Single and twin gang
- Panel cut out:  
Single 19.3 x 6.8  
Twin 19.3 x 13.4

## Approvals and specifications

10(6)A 250Vac T100 1E4 (10,000 Operations)  
6(2)A 250Vac T100 5E4 (50,000 Operations)  
Inrush rating 10/50A 1E4 (10,000 Operations)

UL CSA 15A 250Vac (Twin unit is 10A 250Vac)  
UL CSA 125Vac 1/2hp  
UL 100°C, file E45221, CSA file LR10990

3mm contact gap.

Terminal	Function	Rocker	Body	Body Colour	Rocker Colour
<p><b>H</b></p>	<p>Switches are ON when pressed over terminal 1</p> <p><b>8800</b></p> <p>ON - OFF Single pole</p>		<p>A. Single pole</p> <p>*Optional profile for orientation</p>	<p><b>B</b> Black</p> <p><b>R</b> Red</p>	<p><b>B</b> Black</p> <p><b>R</b> Red</p>
<p><b>T</b></p>	<p>Switches are ON when pressed over terminal 1 or 3</p> <p><b>8800</b></p> <p>ON - OFF Twin pole</p>		<p>B. Single pole - Twin</p> <p>*Optional profile for orientation</p> <p>Panel thickness      Dim X 0.75-1.2              19.1/19.2 1.25-1.99            19.3/19.4 2.00-3.00            19.7/19.8</p> <p>Cut-outs must be punched in the direction of insertion</p>	<p><b>W</b> White</p>	<p><b>W</b> White</p>
<p><b>X</b></p>	<p><b>8800</b></p> <p>ON - OFF Twin pole</p>				

## Dimensions

8800VA (H terminals shown)

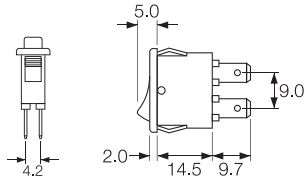

8800V/8800VA (H terminals shown)

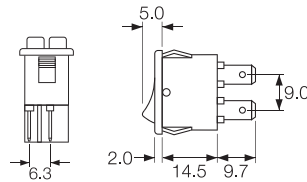

Legend	Legend Colour	Options
Blank	Blank	<p><b>Finish</b> Matt finish only.</p> <p><b>Colour</b> Call sales for custom colours. A full range is available for large orders.</p> <p><b>Legend printing</b> Select from the examples or call sales for custom legends.</p>
<b>132</b>	<b>B</b> Black	
	<b>W</b> White	

## Examples



☐ X8800VA



☐ X8800VA  
☐ T8800VA ---



☐ X8800VA  
☐ T8800VA ---



☐ H8800V/H8800VA  
☐ T8800V/T8800VA



☐ H8800V/H8800VA  
☐ T8800V/T8800VA

# 8500 Rocker Switches - Miniature

10A 250Vac Single & Double Pole



## Key Features

- Miniature rocker switch
- Ratings up to 15A, 250Vac
- Single & double pole in same body size
- Illuminated & non-illuminated
- Matching indicators
- Industry standard panel cut-out
- Rotary and push button actuator options
- BioCote antimicrobial option
- Panel cut out: 19.3 x 12.9

## Approvals and specifications

- 10(6)A 250Vac T125 IE4 (non lit types)  
6(4)A 250Vac T125 5E4 (50,000 Operations)  
10(6)A 250Vac T100 (lit types)
  - UL CSA 15A Non Ind 250Vac, 14A Ind 250Vac, 10A 277Vac  
UL CSA 250Vac 1/2hp, 125Vac 1/4hp  
UL 105°C, (non lit) file E45221, CSA file LR10990
  - BioCote antimicrobial additive. Independently verified to ISO22196:2007.
- 3mm contact gap.

Terminal	Function	Rocker	Body	Body Colour	Rocker Colour								
<p><b>H</b></p> <p>4.8 x 0.8 8.5</p>	<p>ON OFF Switches are ON when pressed over terminal 1</p>	<p><b>H</b> Slotted for custom caps</p> <p>Slots for snap-in buttons</p>	<p><b>B</b> Standard body with terminal barrier</p> <p>Panel cut out: 12.9 x X Bezel: 15.0 x 21.0</p>	<p><b>B</b> Black</p>	<p><b>B</b> Black</p>								
<p><b>K</b></p> <p>2.6 2.8 x 0.8 8.5</p>	<p><b>8500</b></p> <p>ON - OFF Single pole (Uses terminals 1a &amp; 2a)</p>	<p><b>R</b> Semi-rotary (not lit)</p>	<p><b>BC</b> Body without terminal barrier</p> <p>Panel cut out: 12.9 x X Bezel: 15.0 x 21.0</p> <p>Dimensions for snap-in fixing</p> <table border="1"> <thead> <tr> <th>Panel thickness</th> <th>Dim X</th> </tr> </thead> <tbody> <tr> <td>0.75-1.25</td> <td>19.1/19.2</td> </tr> <tr> <td>1.25-2.00</td> <td>19.3/19.4</td> </tr> <tr> <td>2.00-3.00</td> <td>19.7/19.8</td> </tr> </tbody> </table> <p>Cut-outs must be punched in the direction of insertion</p>	Panel thickness	Dim X	0.75-1.25	19.1/19.2	1.25-2.00	19.3/19.4	2.00-3.00	19.7/19.8	<p><b>R</b> Red</p>	<p><b>R</b> Red</p>
Panel thickness	Dim X												
0.75-1.25	19.1/19.2												
1.25-2.00	19.3/19.4												
2.00-3.00	19.7/19.8												
<p><b>L</b></p> <p>2.6 2.8 x 0.8 3.2</p> <p>Right angle version of K terminal available on 8500 only</p>	<p><b>8503</b></p> <p>ON (lit) - OFF Single pole</p>	<p><b>D</b> Paddle lever (not lit)</p>	<p><b>W</b> White</p>	<p><b>W</b> White</p>									
<p><b>R</b></p> <p>1.5 4.8 x 0.8 4.5</p>	<p><b>8550</b></p> <p>ON - OFF Double pole</p>	<p><b>V</b> Curved (not lit)</p>	<p><b>V</b> Curved (lit)</p>										
<p><b>R</b></p> <p>1.5 4.8 x 0.8 4.5</p>	<p><b>8553</b></p> <p>ON (lit) - OFF Double pole</p>	<p><b>X</b> Two colour (not lit)</p>											
<p><b>T</b></p> <p>3.5 4.8 x 0.8 8.5</p> <p>Solder</p>	<p><b>8580</b> Available with H terminals only</p> <p>Indicator</p> <p>UL/CSA E83363</p>	<p><b>A</b> Softline lens</p>											
		<p><b>P</b> Push button operation (8500 only) See drawing opposite</p>											

## Dimensions

“B” body with barrier for H, T and K terminals

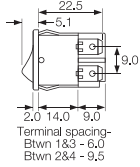

“BC” body w/o barrier primarily for L or R terminals (can be used for all terminals)

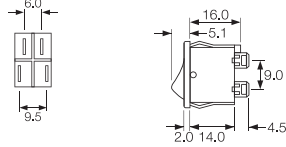

‘PO’ Actuator and body - push button function (8500 only)

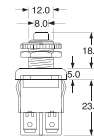
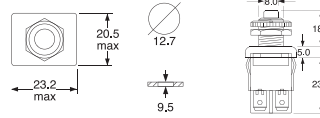

Insert Colour	Lamp Voltage	Legend	Legend Colour	Options	Biocote
<b>X</b> Rocker Only	Blank	Blank	Blank	<p><b>Finish</b> Matt finish only.</p> <p><b>Colour</b> Call sales for custom colours. A full range is available for large orders.</p> <p><b>Legend printing</b> Select from the examples or call sales for custom legends.</p> <p><b>Lamp voltage</b> Call sales for details of available voltages.</p> <p><b>Protective cover L167</b> Snaps on to bodies with V or X style rockers and A lens. This reduces panel thickness by 0.8mm.</p>	<b>B</b> Biocote
<b>R</b> Red	<b>2</b> 125V Neon	<b>076</b>	<b>B</b> Black		
<b>W</b> White	<b>3</b> 250V Neon		<b>W</b> White		
Blank Leave blank for other Rocker types	<b>7</b> 12V Filament				
	<b>8</b> 24V Filament			 <p><b>BioCote Antimicrobial Additive</b> Moulded components have antimicrobial properties using BioCote silver ion technology.</p>	

## Examples



H8500VB ---  
T8500VB ---



H8550VB ---  
T8550VB ---



H8550HB ---  
T8550HB ---



H8550XB ---  
T8550XB ---



H8550RB Semi-rotary  
A splash proofing option



H8500PO ---  
Pushbutton option



H8553VB ---  
T8553VB ---



H8580AB ---

# 8600 Rocker Switches - Miniature

10A 250Vac Single & Double Pole



## Key Features

- Miniature rocker switch
- Ratings up to 16A, 250Vac
- Single & double pole
- ON/OFF, C/O, biased and centre off switching
- Push on, solder and PCB terminals
- Illuminated and non illuminated
- Matching indicators
- Panel cut out single: 19.3 x 12.9 double: 19.3 x 21.9

## Approvals and specifications

- 10(4)A 250Vac T90 (unless noted below)
- UL CSA See ratings below  
UL 65°C, file E45221, CSA file LR10990
- 3mm contact gap except where marked  $\mu$ .

Terminal	Function	UL 15 UL C	Rocker	Body	Body Colour																								
<p><b>H</b></p> <p>4.8 x 0.8 7.4</p> <p><b>T</b></p> <p>Ø2.2 6.4 3.5 x 0.8 Solder</p> <p><b>X</b></p> <p>3.7 5.3 PCB 0.65sq</p> <p>Double Pole switches with "X" terminals are supplied without terminal barriers</p>	<p>Approvals &amp; ratings vary with function</p> <p><b>8600</b></p> <p>10(4)A 16A 250V, 10A 277V 1/2HP 277V, 1/4HP 125V ON - OFF</p> <p><b>8601</b></p> <p>6(1)A 16A 250V, 6A 277V ON - OFF (momentary ON)</p> <p><b>8602</b></p> <p>10A 6A 277V ON - OFF (momentary OFF)</p> <p><b>N/A</b></p> <p>ON - OFF Lit</p> <p><b>8610</b></p> <p>6(1)A 10A 277V 1/2HP 277V, 1/4HP 125V ON - ON</p> <p><b>8611</b></p> <p>6A 277V ON - ON (momentary 1 side)</p> <p><b>8620 <math>\mu</math></b></p> <p>ON - OFF - ON</p> <p><b>8630</b></p> <p>6(1)A UL E63363 CSA LR29381 KEMA-KUER</p> <p>Indicators</p>	<p>ON OFF Switches are ON when pressed over terminal 3</p> <p><b>8650</b></p> <p>10(4)A 10A 277V 1/2HP 277V, 1/4HP 125V ON - OFF</p> <p><b>8651</b></p> <p>6(1)A 6A 277V ON - OFF (momentary ON)</p> <p><b>8652</b></p> <p>10(4)A 6A 277V ON - OFF (momentary OFF)</p> <p><b>8653</b></p> <p>10(4)A 6A 277V ON - OFF Lit</p> <p><b>8660</b></p> <p>6(1)A 10A 277V 1/2HP 277V, 1/4HP 125V ON - ON</p> <p><b>8661</b></p> <p>6A 277V ON - ON (momentary 1 side)</p> <p><b>8670 <math>\mu</math></b></p> <p>ON - OFF - ON</p> <p><b>N/A</b></p>	<p><b>V</b> Curved</p> <p><b>V</b> Curved (lit)</p> <p><b>H</b> Slotted for actuator (8600 and 8610 only)</p> <p>Slots for snap-in buttons</p> <p><b>F</b> Flat Indicator only (Single pole)</p>	<p><b>B</b> Single pole</p> <p>Panel cut out</p> <p>Bezel</p> <p>Single Pole dimensions for snap-in fixing</p> <table border="1"> <tr> <td>Panel thickness</td> <td>Dim X</td> </tr> <tr> <td>0.75-1.25</td> <td>19.1/19.2</td> </tr> <tr> <td>1.25-1.99</td> <td>19.3/19.4</td> </tr> <tr> <td>2.00-3.00</td> <td>19.7/19.8</td> </tr> </table> <p><b>B</b> (Double Pole) with terminal barrier</p> <p><b>BC</b> (Double Pole) w/o terminal barrier</p> <p>Panel cut out</p> <p>Bezel</p> <p>Double Pole dimensions for snap-in fixing</p> <table border="1"> <tr> <td>Panel thickness</td> <td>Dim X</td> </tr> <tr> <td>0.75-1.24</td> <td>19.1/19.2</td> </tr> <tr> <td>1.25-1.99</td> <td>19.3/19.4</td> </tr> <tr> <td>2.00-3.00</td> <td>19.7/19.8</td> </tr> </table> <p>Double Pole dimensions for snap-in fixing</p> <p>Panel thickness</p> <table border="1"> <tr> <td>0.75-1.24</td> <td>Dim X</td> </tr> <tr> <td>1.25-1.99</td> <td>19.1/19.2</td> </tr> <tr> <td>2.00-3.00</td> <td>19.3/19.4</td> </tr> <tr> <td></td> <td>19.7/19.8</td> </tr> </table> <p>Cut-outs must be punched in the direction of insertion</p>	Panel thickness	Dim X	0.75-1.25	19.1/19.2	1.25-1.99	19.3/19.4	2.00-3.00	19.7/19.8	Panel thickness	Dim X	0.75-1.24	19.1/19.2	1.25-1.99	19.3/19.4	2.00-3.00	19.7/19.8	0.75-1.24	Dim X	1.25-1.99	19.1/19.2	2.00-3.00	19.3/19.4		19.7/19.8	<p><b>B</b> Black</p> <p><b>R</b> Red</p> <p><b>W</b> White</p>
	Panel thickness	Dim X																											
	0.75-1.25	19.1/19.2																											
	1.25-1.99	19.3/19.4																											
	2.00-3.00	19.7/19.8																											
	Panel thickness	Dim X																											
	0.75-1.24	19.1/19.2																											
	1.25-1.99	19.3/19.4																											
	2.00-3.00	19.7/19.8																											
	0.75-1.24	Dim X																											
1.25-1.99	19.1/19.2																												
2.00-3.00	19.3/19.4																												
	19.7/19.8																												



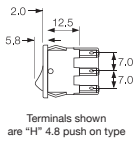

## Dimensions

Single pole

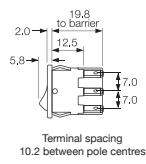

Double pole



Rocker Colour	Lamp Voltage	Legend	Legend Colour	Options
Lit (DP)	Blank	Blank	Blank	<p><b>Finish</b> Matt finish only.</p> <p><b>Colour</b> Call sales for custom colours. A full range is available for large orders.</p> <p><b>Legend printing</b> Select from the examples or call sales for custom legend.</p> <p><b>Lamp voltage</b> Call sales for details of available voltages.</p> <p><b>Blanking plate A8634FB</b> Dummy unit to fill unused panel holes. Single pole size only.</p> <p><b>Protective covers</b> L167 for SP L180 for DP Snap on to bodies with V rocker or F lens. This reduces panel thickness by 2.2mm.</p>  <p><b>Single Pole options</b> Most switches shown can have single pole switching in double pole bodies.</p>
<b>A</b> Amber	<b>2</b> 125V Neon	<b>076</b>	<b>B</b> Black	
<b>C</b> Clear	<b>3</b> 250V Neon		<b>W</b> White	
<b>G</b> Green	<b>7</b> 12V Filament			
<b>R</b> Red	<b>8</b> 24V Filament			
Lit (DP)			<b>B</b> Black	
<b>R</b> Red				
<b>W</b> White				

## Examples



H8600VB ---  
T8600VB ---



H8600VB ---  
T8600VB ---



H8630FB ---  
T8630FB ---



H8650VB ---  
T8650VB ---



H8660VB ---  
T8660VB ---



H8653VB ---  
T8653VB ---

# 8620 & 8670 Rocker Switches

3 Positions - 10A 250Vac



## Key Features

- 3 position miniature rocker switch
- Ratings up to 15A, 250Vac
- Single & double pole
- Centre off switching
- Push on, solder and PCB terminals
- Matching indicators
- Panel cut out: single: 19.3 x 12.9 double: 19.3 x 21.9

## Approvals and specifications

- UL 10(4)A 250Vac T90
- UL CSA 15A 277Vac (Single pole)
- UL CSA 250Vac 1/2hp (Single pole)
- UL CSA 125Vac 1/4hp (Single pole)
- UL CSA 10A 277Vac (Double pole)
- UL CSA 277Vac 1/2hp (Single & Double pole)
- UL 90°C, file E45221, CSA file LR10990
- µ contact gap.

Terminal	Function	Rocker	Body	Body Colour	Rocker Colour
<p><b>H</b></p> <p>4.8 x 0.8</p>	<p><b>8620</b></p> <p>ON - OFF - ON Single pole</p>	<p><b>V</b></p> <p>Curved</p>	<p><b>B</b> Single pole</p> <p>Panel thickness 0.75-1.24 1.25-1.99 2.00-3.00</p> <p>Dim X 19.1/19.2 19.3/19.4 19.7/19.8</p>	<p><b>B</b> Black</p> <p><b>R</b> Red</p> <p><b>W</b> White</p>	<p>Lit (DP)</p> <p><b>A</b> Amber</p> <p><b>C</b> Clear</p> <p><b>G</b> Green</p> <p><b>R</b> Red</p> <p>Lit (DP)</p> <p><b>B</b> Black</p> <p><b>R</b> Red</p> <p><b>W</b> White</p>
<p><b>T</b></p> <p>Ø2.15 6.4 Solder</p>	<p><b>8670</b></p> <p>ON - OFF - ON Double pole</p>	<p><b>H</b></p> <p>Slotted for actuator (8620 only)</p>	<p><b>B</b> Single pole - Twin</p> <p>Panel thickness 0.75-1.24 1.25-1.99 2.00-3.00</p> <p>Dim X 19.1/19.2 19.3/19.4 19.7/19.8</p> <p><small>Cut-outs must be punched in the direction of insertion</small></p>	<p><b>B</b> Black</p> <p><b>R</b> Red</p> <p><b>W</b> White</p>	<p>Lit (DP)</p> <p><b>B</b> Black</p> <p><b>R</b> Red</p> <p><b>W</b> White</p>

## Dimensions

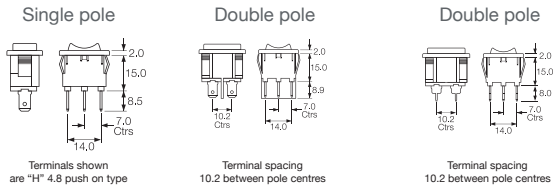

Lamp Voltage	Legend	Legend Colour	Options
Blank	Blank	Blank	<p><b>Finish</b> Matt finish only.</p> <p><b>Colour</b> Call sales for custom colours. A full range is available for large orders.</p> <p><b>Legend printing</b> Select from the examples or call sales for custom legend.</p> <p><b>Lamp voltage</b> Call sales for details of available voltages.</p> <p><b>Blanking plate A8634FB</b> Dummy unit to fill unused panel holes. Single pole size only.</p> <p><b>Protective covers</b> L167 for SP L180 for DP Snap on to bodies with V rocker or F lens. This reduces panel thickness by 2.2mm.</p> 
<b>2</b> 125V Neon	<b>076</b>	<b>B</b> Black	
<b>3</b> 250V Neon		<b>W</b> White	
<b>7</b> 12V Filament			
<b>8</b> 24V Filament			<p><b>Single Pole options</b> Most switches shown can have single pole switching in double pole bodies.</p>

# 1250 Rocker Switches

10A 250Vac



## Key Features

- Standard rocker switch
- Double pole in single pole body
- Snap in or sub panel mount
- Integral terminal barrier
- Push on or PCB terminals
- Panel cut out: 27.2 x 12.4 (snap in) 26.3 x 12.4 (sub panel mount)

Terminal	Function	Rocker	Body	Body Colour	Rocker Colour
<p><b>C</b></p> <p>On when pressed over terminal 1</p> <p>6.3 x 0.8</p>	<p><b>1250</b></p> <p>ON - OFF Double pole Poles are 9.0mm between centres.</p>	<p><b>A</b> Curved</p> <p>Shown in N body</p>	<p><b>N</b></p> <p>Panel cut-out      Bezel</p> <p>Panel thickness      Dim X</p> <p>0.75-1.24              26.1/26.2 1.25-1.99              26.3/26.4 2.00-3.00              26.7/26.8</p>	<p><b>B</b> Black</p> <p><b>W</b> White</p>	<p><b>B</b> Black</p> <p><b>W</b> White</p>
<p><b>X</b></p> <p>On when pressed over terminal 1</p> <p>5.2      9.0</p> <p>PCB 0.8sq (N body only)</p>	<p><b>1250SP</b></p> <p>ON - OFF Single pole</p>	<p>Shown in P body</p>	<p><b>P</b></p> <p>Panel cut out      Bezel</p> <p>Panel thickness</p> <p>0.75-3.00</p> <p><small>Cut-outs must be punched in the direction of insertion</small></p>		<p><b>G</b> Grey</p>

## Approvals and specifications

-  10(6)A 250Vac T100  
6A 400Vac T100  
1A 30Vdc
  -  UL CSA 10A 250Vac  
UL CSA 16A 250Vac Resistive  
UL CSA 125Vac 1/2hp  
UL CSA 1A 30Vdc  
UL 100°C, file E45221, CSA file LR10990
- 3mm contact gap

## Dimensions

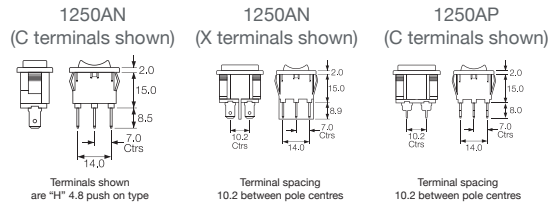

Legend	Legend Colour	Options
— Blank	— Blank	<p><b>Finish</b> Matt finish only.</p> <p><b>Colour</b> Call sales for custom colours. A full range is available for large orders.</p> <p><b>Legend printing</b> Select from the examples or call sales for custom legend.</p>
<b>085</b>	<b>B</b> Black	
	<b>W</b> White	

# 6000 SP Splash Resistant Rocker Switches

16A 250Vac



## Key Features

- Ratings up to 20A, 277Vac
- Positive switch action
- Distinctive styling
- Illuminated & nonilluminated
- Single pole
- Panel cut out: 30.1 x 11.1mm

## Approvals and specifications

- European 16(4)A 250Vac T125, 10A 400Vac T125
  - UL = 20A 277Vac, 1 1/2HP 250Vac 1HP 125Vac  
CSA = 20A 277Vac, 1HP 125Vac, 1/2HP 125Vac
- 3mm contact gap with Positive Break switching.  
Call factory for IP details.

Terminal	Function	Rocker	Body	Body Colour	Rocker Colour	Lamp Voltage
<p><b>C</b></p> <p>6.3 x 0.8</p> <p>9.7</p>	<p><b>6000</b></p> <p>ON - OFF</p>	<p><b>A</b></p> <p>Softline Matt</p> <p><b>A</b></p> <p>Softline Matt</p> <p><b>P</b></p> <p>Lit window Matt</p>	<p><b>L</b></p> <p>Panel cut-out ** Bezel</p> <p>30.0/30.1</p> <p>11.0/11.1</p> <p>14.0</p> <p>31.5</p> <p>R2.0</p> <p>Cut-outs must be punched in the direction of insertion</p>	<p><b>B</b></p> <p>Black</p> <p><b>W</b></p> <p>White</p>	<p>Lit (DP)</p> <p><b>A</b></p> <p>Amber</p> <p><b>C</b></p> <p>Clear</p> <p><b>G</b></p> <p>Green</p> <p><b>R</b></p> <p>Red</p> <p>Lit (DP)</p> <p><b>B</b></p> <p>Black</p> <p><b>R</b></p> <p>Red</p> <p><b>W</b></p> <p>White</p>	<p>Blank</p> <p><b>2</b></p> <p>125V Neon</p> <p><b>3</b></p> <p>250V Neon</p> <p><b>5</b></p> <p>12Vdc LED (P Rocker)</p> <p><b>6</b></p> <p>24Vdc LED (P Rocker)</p> <p><b>7</b></p> <p>12V Filament</p> <p><b>8</b></p> <p>24Vdc Filament</p>
	<p><b>6001</b></p> <p>ON - OFF (momentary ON)</p>					
	<p><b>6002</b></p> <p>ON - OFF (momentary OFF)</p>					
	<p><b>6003</b></p> <p>ON - OFF Lit</p>					
	<p><b>6008</b></p> <p>ON - OFF Lit (Unswitched neutral)</p>					
	<p><b>6009</b></p> <p>ON - OFF (momentary ON) Lit (Unswitched neutral)</p>					
	<p><b>6010</b></p> <p>ON - ON</p>					
	<p><b>6011</b></p> <p>ON - ON (momentary 1 side)</p>					

### Dimensions

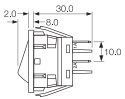

Panel thickness  
L 0.75 to 2.5mm  
\*\* For cut-out details  
on momentary switches  
call sales

### Integral Splash Resistance



Current carrying parts are protected from moisture. Droplets which may enter the switch are channelled out through ports in the switch body. For IP65 see options below

Legend	Legend Colour	Options
Blank	Blank	<b>G74</b> Protective Cover
<b>1223</b>	<b>B</b> Black	<p><b>Finish</b> Matt is standard.</p> <p><b>Colour</b> Call sales for custom colours. A full range is available for large orders.</p> <p><b>Legend printing</b> Select from the examples or call sales for custom legends.</p> <p><b>Lamp voltage</b> Call sales for details.</p> <p><b>Protective cover</b> A snap on cover is available (add G after body code), this reduces panel thickness by 2mm.</p>  <p>Panel sealing washer W46 is available, this reduces panel thickness by 1.2mm.</p> <p>Covers are not suitable for momentary types. For all options call the factory</p>
	<b>W</b> White	

### Examples



☐ C6000AL - - -



☐ C6000AL - - -



☐ C6010AL - - -



☐ C6003AL - - -



☐ C6003PL - - -



☐ C6030AL - - -

# 6050 DP Splash Resistant Switches

& Twin Switches - 16A 250Vac

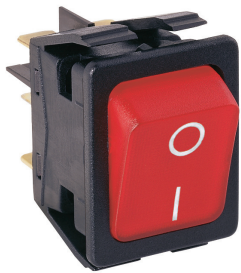

## Key Features

- Ratings up to 20A, 277V ac
- Positive switch action
- Distinctive styling
- Illuminated & non-illuminated
- Double pole
- BioCote antimicrobial option (Double pole only)
- DC LED Illumination Available
- Panel cut out: 30.1 x 22.2mm

## Approvals and specifications

European 16(4)A 250Vac T125, 10A 400Vac T125

UL CSA (except 6054 & 6055 Switches) 20A 277Vac, 250Vac 11/2hp, 125Vac 1hp

UL 100°C, file E45221, CSA file LR10990

BioCote antimicrobial additive. Independently verified to ISO22196:2007.

3mm contact gap with Positive Break switching.

Terminal	Function	Rocker	Body	Body Colour	
<b>C</b>  6.3 x 0.8 9.7	<b>6050</b>  ON - OFF	<b>A</b> Softline Matt 	<b>L</b> Double Pole Panel cut-out ** Bezel 	Lit (DP)  <b>A</b> Amber	
	<b>6051</b>  ON - OFF (momentary ON)				<b>6059</b>  ON - OFF (Single pole) (momentary ON) Isolated light
<b>H</b>  4.8 x 0.8 9.7	<b>6052</b>  ON - OFF (momentary OFF)	<b>A</b> Softline Matt 	<b>L</b> Twin units Contact sales for information on splash resistance and IP ratings 	<b>G</b> Green	
	<b>6053</b>  ON - OFF Lit				<b>P</b> Lit window Matt 
<b>S</b>  Screw & Clamp N/A for assemblies with 3 terminals 9.7	<b>6054</b>  ON - OFF (momentary ON) Lit	<b>P</b> Lit window Matt 		Un-Lit (DP)	
	<b>6055</b>  ON - OFF (Single pole) (momentary ON) Lit				<b>B</b> Black
	<b>6056</b>  ON - OFF (Single pole) Isolated light				<b>R</b> Red
	<b>6057</b>  ON - OFF Isolated light				<b>W</b> White
	<b>6058</b>  ON - OFF (Single pole) Lit				



## Integral Splash Resistance

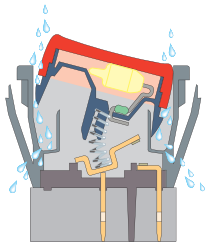

Current carrying parts are protected from moisture. Droplets which may enter the switch are channelled out through ports in the switch body.

For IP65 see options below

## Dimensions

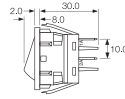



Panel thickness

L 0.75 to 2.5mm

\*\* For cut-out details on momentary switches call sales

Terminal spacing - Poles 10.5 between centres

Rocker Colour	Lamp Voltage	Legend	Legend Colour	Options	BioCote
<b>B</b> Black	Blank	Blank	Blank	<b>G74</b> Protective Cover	<b>B</b> BioCote
<b>R</b> Red	<b>2</b> 125V Neon	<b>1223</b>	<b>B</b> Black	<p><b>Finish</b> Matt is standard.</p> <p><b>Colour</b> Call sales for custom colours. A full range is available for large orders.</p> <p><b>Legend printing</b> Select from the examples or call sales for custom legends.</p> <p><b>Protective cover</b> The 6050 series is a water through design. For a higher level of sealing, a snap on cover is available (add G after body code). This reduces panel thickness by 1mm.</p>  <p>Panel sealing washer W42 is available. This reduces panel thickness by 1.00mm. Covers are not suitable for momentary types.</p> <p><b>IP Ratings</b> Call the sales for details.</p> <p><b>Terminal Link P1067</b> connects the poles of a double pole switch or twin unit.</p> <p># Mounting orientation may affect IP rating.</p> <p><b>BioCote Antimicrobial Additive</b> </p> <p>Moulded components have antimicrobial properties using BioCote silver ion technology. For all options call sales.</p>	
<b>W</b> White	<b>3</b> 250V Neon		<b>W</b> White		
	<b>5</b> 12Vdc LED (P Rocker)				
	<b>6</b> 24Vdc LED (P Rocker)				
	<b>7</b> 12V Filament				
	<b>8</b> 24Vdc Filament				

## Examples



☐ C6050AL - - -



☐ C6053AL - - -



☐ C6053PL - - -



☐ C6000A/C6000AL



☐ C6003P/C6003PL



☐ C6003P/C6030AL

# 1500 Standard & 1300 High Inrush Switches

150A to EN61058-1 and 16A 250Vac



## Key Features











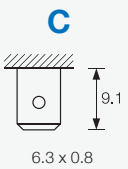

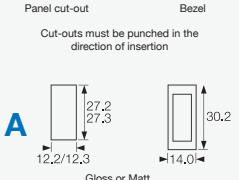
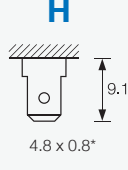

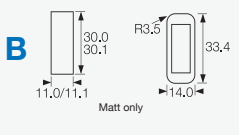
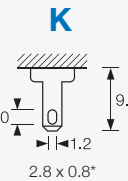
- Standard rocker switch
- Non-illuminated
- 150A inrush
- Choice of switching circuits including 3 position
- Choice of bezel styles
- Choice of panel cut outs
- Matching indicator
- Single pole
- Splash resistant option
- BioCote antimicrobial option
- DC LED Illumination Available for "P" Rocker
- Panel cut out 'A' style: 27.3 x 12.3mm

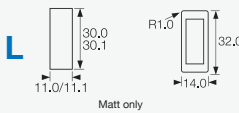
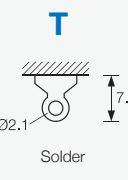
## Approvals and specifications

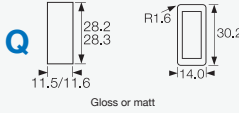
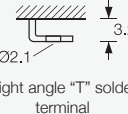
- UL 1500 Series 16(4)A 250Vac T125
- UL CSA 16A Non Ind 250Vac, (2 posn) 250Vac 1hp, 125Vac 1/2hp, (3 posn) 250Vac 1/2hp, 125Vac 1/4hp  
1330 36Vdc 14A  
1350 72 Vdc 7A  
1500 & 1510 14 Vdc 10A  
UL 85°C, file E45221, CSA file LR10990

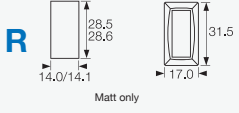
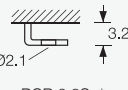
**In house test:**  
10A 24Vdc— Indicative rating only

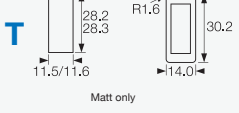
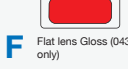
1300 series 16(6)A 250Vac T125 5E4 (50,000 Ops.)  
150A Inrush to EN61058-1

Terminal	Function	Rocker	Body	Finish	Body Colour	Rocker Colour
<b>C</b> 	<b>Standard 1500</b> ON - OFF	<b>A</b> 	Panel cut-out Bezel Cut-outs must be punched in the direction of insertion <b>A</b> 	<b>M</b> Matt	<b>B</b> Black	Un-Lit
<b>H</b> 	<b>1501</b> HP rating N/A ON - OFF (momentary ON)	<b>B</b> 	<b>B</b> 	<b>G</b> Gloss	<b>R</b> Red	<b>B</b> Black
<b>K</b> 	<b>1502</b> HP rating N/A ON - OFF (momentary OFF)	<b>H</b> 	<b>L</b> 	Applies to both Rocker & Body	<b>W</b> White	<b>R</b> Red
<b>T</b> 	<b>1510 µ</b> HP rating N/A ON - ON	<b>V</b> 	<b>Q</b> 		<b>A</b> Amber	
<b>U</b> 	<b>1511 µ</b> HP rating N/A ON - ON (momentary 1 side)	<b>W</b> 	<b>R</b> 	<b>C</b> Clear		
<b>X</b> 	<b>1520 µ</b> 125V & 250V 1/2 HP H terminal rated T100 only ON - OFF - ON	<b>X</b> 	<b>T</b> 	<b>G</b> Green		
	<b>1521 µ</b> HP rating N/A H terminal rated T100 only ON - OFF - ON (momentary 1 side)	<b>F</b> 		<b>A</b> Amber		
	<b>1522 µ</b> HP rating N/A H terminal rated T100 only ON - OFF - ON (momentary 2 sides)	<b>A</b> 		<b>R</b> Red		
	<b>0430</b> HP rating N/A H terminal rated T100 only ON - OFF					
	<b>High Inrush 1300</b>					

### Dimensions

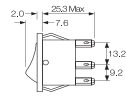

**Panel thickness**  
 A,Q 0.75 to 3.3mm  
 L,B,T 0.75 to 2.5mm  
 R 0.75 to 3.0mm

\* For cut-out details on momentary switches call sales

### Splash Resistance

#### 1500 W and B splash resistant options

Feather edge seals and a close fitting collar protect current carrying parts from moisture. B option has Hytrel collar/seals for enhanced protection.

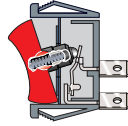

#### 1300 High inrush, positive break switching

The 1300 series mechanism ensures contact welds formed at switch-on are positively separated by the plunger tube acting directly on the step in the moving contact.

UL CSA 20A 250Vac 1hp, 125Vac 1/2hp  
 UL 85°C, file E45221, CSA file LR10990

#### In house test:

20A 24Vdc — Indicative rating only

BioCote antimicrobial additive. Independently verified to ISO22196:2007.

3mm contact gap except if marked  $\mu$ .

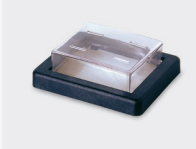
Lamp Voltage	Insert Colour	Legend	Legend Colour	Options	Biocote
Blank	Blank	Blank	Blank	<p><b>Finish</b> Matt is standard.</p> <p><b>Colour</b> Call sales for custom colours. A full range is available for large orders.</p> <p><b>Legend printing</b> Select from the examples or call sales for custom legends.</p> <p><b>Lamp voltage</b> Call sales for details.</p> <p><b>Blanking plates A0434 - -</b> Dummy units to fill unused panel holes.</p> <p><b>Protective cover</b> Snaps on to A, L, Q or T bodies (add G after body code in cat no.), this reduces panel thickness by 1mm.</p>  <p>Panel sealing washer W46 is available for the same body sizes, this reduces panel thickness by a further 0.8mm. Covers are not suitable for momentary types.</p> <p><b>BioCote Antimicrobial Additive</b> Moulded components have antimicrobial properties using BioCote silver ion technology.</p> <p>For all options call sales.</p>	<b>B</b> BioCote
<b>2</b> 125V Neon	<b>R</b> Red	<b>602A</b>	<b>B</b> Black		
<b>3</b> 250V Neon	<b>W</b> White		<b>W</b> White		
<b>7</b> 12V Filament					
<b>8</b> 24Vdc Filament					

### Examples



C1500AR ---  
 T1500AR ---



C1500AL ---  
 T1500AL ---



C1500XL ---  
 T1500XL ---



C1510AL ---  
 T1510AL ---



C1520AL ---  
 T1520AL ---



C0430AL ---  
 T0430AL ---

# 5500 Lit Rocker Series

10A 250Vac



## Key Features

- Standard rocker switch
- Single pole
- Illuminated
- Splash resistant option
- Choice of switching circuits
- Panel cut out 'A' style:
- Choice of bezel styles
- Choice of panel cut outs
- Matching indicator

## Approvals and specifications

16(4)A 250Vac T85  
10(3)A 250Vac T100, (12A 250Vac T125 for P rocker only)

UL CSA 15A 250Vac, CSA 16A Non Ind 250Vac  
UL CSA 250Vac 1hp, 125Vac 1/2hp  
UL 85°C, file E45221, CSA file LR10990

μ contact gap.

For Twin units repeat the order details for both the left and right sides.

Terminal	Function	Rocker	Body	Body Colour	Rocker Colour
<p><b>C</b></p> <p>6.3 x 0.8</p>	<p>Approvals &amp; ratings vary with function ON OFF Switches - ON when pressed over terminal 3</p>	<p><b>A</b> Softline (Matt only)</p>	<p><b>A</b> Panel Cut - outs</p> <p><b>Bezel</b></p>	<p><b>B</b> Black</p>	<p>Un-Lit</p> <p><b>B</b> Black</p>
<p><b>H</b></p> <p>4.8 x 0.8</p>	<p><b>5500 μ</b></p> <p>ON - OFF Single pole</p>	<p><b>P</b> Lit window (Matt only)</p>	<p><b>B</b></p> <p><b>Bezel</b></p>	<p><b>W</b> White</p>	<p><b>R</b> Red</p> <p><b>W</b> White</p>
<p><b>T</b></p> <p>Ø2.1</p> <p>Solder</p>	<p><b>5503 μ</b></p> <p>ON - OFF Lit Switched neutral</p> <p><b>5508 μ</b></p> <p>ON - OFF Lit Unswitched neutral</p>	<p><b>L</b></p>	<p><b>L</b></p> <p><b>Bezel</b></p>		<p>Lit</p>
			<p><b>Q</b></p> <p><b>Bezel</b></p>		<p><b>A</b> Amber</p> <p><b>C</b> Clear</p>
			<p><b>R</b></p> <p><b>Bezel</b></p>		<p><b>G</b> Green</p>
			<p><b>T</b></p> <p><b>Bezel</b></p>		<p><b>R</b> Red</p>

## Dimensions

**Panel thickness**  
**A,Q** 0.75 to 3.3mm  
**L,B,T** 0.75 to 2.5mm  
**R** 0.75 to 3.0mm

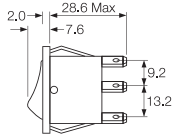

**Twin units**  
 Two single switches or a switch and an indicator light can be assembled side by side in one double pole body.  
 For 5500 range panel cut-out details (L, B and T) call sales.

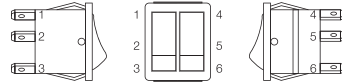

Terminal spacing -  
 Poles 10.8 between centres (twin units)

For twin units the first set of order format details refer to the left hand unit, when looking at the front of the assembly.  
 (This has terminal numbers 1, 2 & 3)

Lamp Voltage	Legend	Legend Colour	Options
Blank	Blank	Blank	<p><b>Finish</b> Matt is standard.</p> <p><b>Colour</b> Call factory for custom colours. A full range is available for large orders.</p> <p><b>Legend printing</b> Select from the examples or call factory for custom legends.</p> <p><b>Lamp voltage</b> Call factory for details.</p> <p><b>Blanking plate A0434 - - (SP) A0494 - - (DP)</b> Dummy units to fill unused panel holes.</p> <p><b>Protective cover</b> Snaps on to A, L, Q or T bodies (add G after body in cat no.), this reduces panel thickness by 1.00mm.</p>  <p>Panel sealing washers W46 (Single Pole) and W42 (Double Pole) are available for these body types, this reduces panel thickness by 2mm.</p> <p>For all options call the factory.</p>
<b>2</b> 125V Neon	<b>602A</b>	<b>B</b> Black	
<b>3</b> 250V Neon		<b>W</b> White	
<b>5</b> 12Vdc LED (P Rocker)			
<b>6</b> 24Vdc LED (P Rocker)			
<b>7</b> 12V Filament			
<b>8</b> 24Vdc Filament			

## Examples



☐ C5503AL - - -



☐ C5500AL - - -



☐ C5503PL - - -



☐ C5503A/  
C5430AL



☐ C5503A/C5503AL



☐ C5503P/C5503PL

# 1500 Twin Units Switches and Indicators

16A 250Vac



## Key Features

- Twin unit rocker switch
- Choice of switching circuits including 3 position
- Push-on, solder and PCB terminals
- Choice of bezel styles
- Choice of panel cut outs
- Matching indicator
- Single pole switches
- Splash resistant option
- Panel cut out 'A' style: 27.2 x 22.3mm

## Approvals and Specifications

- 16(4)A 250Vac T125
- UL CSA 16A 250Vac
- UL CSA (2 posn) 250Vac 1hp, 125Vac
- 1/2hp, (3 posn) 250 Vac
- 1/2hp, 125Vac 1/4hp
- UL 85°C, file E45221, CSA file LR10990

For versions with High Inrush or for 50,000 operations,  
3mm contact gap except where marked  $\mu$ .

Terminal	Function	Rocker	Body	Finish	Body Colour	Rocker Colour
<p><b>C</b> 6.3 x 0.8</p>	<p>Approvals &amp; ratings vary with function ON OFF Switches - ON when pressed over terminal 1 or 4</p>	<p><b>A</b> Softline (Matt only)</p>	<p>Panel Cut - outs      Bezel</p> <p><b>A</b>            </p> <p>27.2 27.3 22.3/22.4      30.2 25.0 Gloss or Matt</p>	<p><b>M</b> Matt</p>	<p><b>B</b> Black</p>	<p>Un-Lit</p> <p><b>B</b> Black</p>
<p><b>H</b> 4.8 x 0.8</p>	<p><b>1500</b></p> <p>ON - OFF</p>	<p><b>B</b> Softline (Matt only)</p>	<p><b>B</b>      </p> <p>30.0 30.1      R3.5      33.4 22.1/22.2      Matt only      25.0</p>	<p><b>G</b> Gloss</p> <p>Applies to both Rocker &amp; Body</p>	<p><b>W</b> White</p>	<p><b>R</b> Red</p>
<p><b>T</b> 02.1 Solder</p>	<p><b>1510 <math>\mu</math></b></p> <p>ON - ON</p>	<p><b>W</b> Softline (Matt only)</p>	<p><b>L</b>      </p> <p>30.0 30.1      R1.0      32.0 22.1/22.2      Matt only      25.0</p>			<p><b>W</b> White</p>
<p><b>K</b> 2.0 x 1.2</p>	<p><b>1520 <math>\mu</math></b></p> <p>ON - OFF - ON</p>	<p><b>X</b> Softline (Matt only)</p>	<p><b>Q</b>      </p> <p>28.2 28.3      R1.6      30.2 22.3/22.4      Gloss or matt      25.0</p>			<p>Lit</p> <p><b>A</b> Amber</p>
<p><b>X</b> 4.0</p>	<p><b>0430</b></p> <p>Indicator</p>	<p><b>A</b> Softline (Matt only)</p>	<p><b>R</b>      </p> <p>28.4 28.5      33.2 23.0/25.4      Matt only      28.9</p>			<p><b>C</b> Clear</p> <p><b>G</b> Green</p>
			<p><b>T</b>      </p> <p>28.2 28.3      R1.6      30.2 22.3/22.4      Matt only      25.0</p>			<p><b>R</b> Red</p>

## Dimensions

**Panel thickness**  
**A,Q** 0.75 to 3.3mm  
**L,B,T** 0.75 to 2.5mm  
**R** 0.75 to 3.0mm

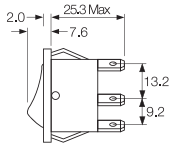

Call sales for terminal spacing details

## Twin units

Two single switches or a switch and an indicator light can be assembled side by side in one double pole body.

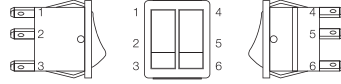

For twin units the first set of order format details refer to the left hand unit, when looking at the front of the assembly.  
 (This has terminal numbers 1, 2 & 3)

## Splash Resistant

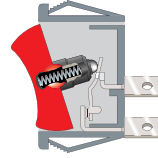

Feather edge seals and a close fitting collar protect current carrying parts from moisture.

B option has Hytrel collar/seals for enhanced protection.

Insert Colour	Lamp Voltage	Legend	Legend Colour	Options	Biocote
Blank	Blank	Blank	Blank	<p><b>Finish</b> Matt is standard.</p> <p><b>Colour</b> Call factory for custom colours. A full range is available for large orders.</p> <p><b>Legend printing</b> Select from the examples or call factory for custom legends.</p> <p><b>Lamp voltage</b> Call factory for details.</p>	<b>B</b> Biocote
<b>R</b> Red	<b>2</b> 125V Neon	<b>602A</b>	<b>B</b> Black		
<b>W</b> White	<b>3</b> 250V Neon		<b>W</b> White		
	<b>5</b> 12Vdc LED (P Rocker)				
	<b>6</b> 24Vdc LED (P Rocker)				
	<b>7</b> 12V Filament				
	<b>8</b> 24Vdc Filament				

## Examples



☐ C1500A/C1500AL



☐ C1500A/C0430AL



☐ C1500X/C1500XL



☐ C1520A/C1510AL



☐ C1500A/C1520AL



☐ C0430A/C0430AL

# 1550 Standard and 1350 High Inrush

150A to EN61058-1 and 16A 250Vac



## Key Features

- Standard rocker switch
- 1350/53 high inrush
- Choice of switching circuits including 3 position
- Push-on, solder and PCB terminals
- Choice of bezel styles
- Choice of panel cut outs
- Matching indicator
- Double pole
- Splash resistant option
- BioCote antimicrobial option
- Panel cut out 'A' style: 27.2 x 22.3mm

## Approvals and specifications

1550 Series 16(4)A 250Vac T125

UL CSA 16A 250Vac, (2 posn) 250Vac 1hp, 125Vac 1/2hp, 1350 72 Vdc 7A (3 posn) 250 Vac 1/2hp, 125Vac 1/4hp. UL 85°C, file E45221, CSA file LR10990.

### In house test:

10A 24Vdc—Indicative rating only

1350 series 16(4)A 250Vac T85 1E4 (10,000 Ops.)  
1330 series 16(6)A 250Vac T125 5E4 (50,000 Ops.)  
150A Inrush to EN61058-1.

Terminal	Function	Rocker	Body
<b>C</b>  6.3 x 0.8	<b>Standard 1550</b>  ON - OFF	<b>A</b> Softline Matt  <b>B</b> Splash resistant Softline  <b>V</b> Curved  Matt or Gloss  Gloss only Lit (not momentary)	Panel cut-out Bezel Cut-outs must be punched in the direction of insertion <b>A</b>  Gloss or Matt <b>B</b>  Matt only <b>L</b>  Matt only <b>Q</b>  Gloss or matt <b>R</b>  Matt only <b>T</b>  Matt only
	<b>1551</b> HP rating N/A  ON - OFF (momentary ON)		
<b>H</b>  4.8 x 0.8*	<b>1552</b> HP rating N/A  ON - OFF (momentary OFF)	<b>W</b> Splash resistant Curved  <b>P</b> Lit window Matt  Lit (not momentary) <b>X</b> Two colour Matt  (ON OFF only - not momentary)	
	<b>1553</b> Not W, X or B rocker  ON - OFF Lit		
<b>K</b>  2.8 x 0.8*	<b>1560 μ</b>  ON - ON	<b>R</b> Round  <b>F</b> Flat Lens Gloss (0480)  <b>A</b> Softline lens Matt (0480 only) as F but with raised profile 	
	<b>1561 μ</b> HP rating N/A  ON - ON (Momentary 1 Side)		
<b>T</b>  Solder	<b>1570 μ</b> 125V & 250V 1/2 HP H terminal rated T100 only H terminal rated T100 only  ON - OFF - ON	<b>U</b>  Right angle "T" solder terminal	
	<b>1571 μ</b> HP rating N/A H terminal rated T100 only  ON - OFF - ON (momentary 1 side)		
<b>U</b>  Right angle "T" solder terminal			
<b>X</b>  PCB 0.8Sq*			



## Approvals and specifications (continued)

**UL** CSA 20A 250Vac 1hp, 125Vac 1/2hp.  
 UL 72Vdc 7A, 36Vdc 14A.  
 UL 85°C, file E45221, CSA file LR10990.

**In house test:**  
 20A 24Vdc—Indicative rating only

BioCote antimicrobial additive. Independently verified to ISO22196:2007.

3mm contact gap except if marked  $\mu$ .

## Splash Resistance



**1300 High inrush, positive break switching**  
 The 1300 series mechanism ensures contact welds formed at switch-on are positively separated by the plunger tube acting directly on the step in the moving contact.

## Dimensions

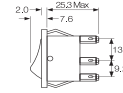

**Panel thickness**  
 A.Q 0.75 to 3.3mm  
 L.B.T 0.75 to 2.5mm  
 R 0.75 to 3.0mm

\* For cut-out details on momentary switches call sales

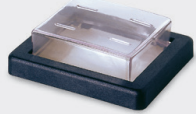
Finish	Body Colour	Rocker Colour	Insert Colour	Lamp Voltage	Legend	Legend Colour	Options
<b>M</b> Matt	<b>B</b> Black	Un-Lit	Blank	Blank	Blank	Blank	<p><b>Finish</b> Matt is standard.</p> <p><b>Colour</b> Call sales for custom colours. A full range is available for large orders.</p> <p><b>Legend printing</b> Select from the examples or call sales for custom legends.</p> <p><b>Lamp voltage</b> Call sales for details.</p> <p><b>Blanking plates A0494</b> Dummy units to fill unused panel holes.</p> <p><b>Protective cover</b> Snaps on to A, L, Q or T bodies (add G after body in cat no). This reduces panel thickness by 1mm.</p>  <p>Panel sealing washer W42 is available for the above body sizes. This reduces panel thickness by a further 1.00mm. Covers are not suitable for momentary types.</p> <p><b>BioCote Antimicrobial Additive</b></p> <p>Moulded components have antimicrobial properties using BioCote silver ion technology.</p> <p>For all options call sales.</p>
		<b>R</b> Red		<b>2</b> 125V Neon			
<b>G</b> Gloss	<b>W</b> White	<b>W</b> White	<b>3</b> 250V Neon	<b>602A</b>	<b>B</b> Black		
		Lit	<b>5</b> 12Vdc LED (P Rocker)				
Applies to both Rocker & Body		<b>A</b> Amber	<b>6</b> 24Vdc LED (P Rocker)		<b>W</b> White		
		<b>G</b> Green	<b>7</b> 12V Filament				
		<b>C</b> Clear	<b>8</b> 24Vdc Filament				
		<b>R</b> Red					

## Examples



□ C1350AL ---



□ C1550XL ---



□ C1553PL ---



□ C1553RA ---  
 Shown with M614 bezel cover

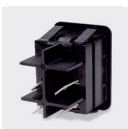

Optional snap-in M441 barrier



C1553AA with M616 guard Cut-out 22.0/22.1 x 29.4/29.5 Guard accepts "A" body only



□ C0480RA ---  
 Shown with M614 bezel cover



□ C0480AL ---

# 1550 Standard & 1350 High Inrush Switches

150A to EN61058-1 and 16A 250Vac/250Vdc



## Key Features

- Standard rocker switch
- 1350/53 high inrush
- Choice of switching circuits including 3 position
- Push-on, solder and PCB terminals
- Choice of bezel styles
- Choice of panel cut outs
- Matching indicator
- Double pole
- Option with guard & cover
- DC LED Illumination Available for "P" Rocker
- Bezel size 'G' style 32.0 x 25.0

## Approvals and specifications

- ☞ 1550 Series 16(4)A 250Vac T125
- UL CSA 16A 250Vac, (2 posn) 250Vac 1hp, 125Vac 1/2hp, (3 posn) 250 Vac 1/2hp, 125Vac 1/4hp. UL 85°C, file E45221, CSA file LR10990.
- In house test:**  
10A 24Vdc— Indicative rating only
- 1350 Series
- UL CSA 20A 250Vac 1hp, 125Vac 1/2hp. UL 72Vdc 7A, 36Vdc 14A, UL 85°C, file E45221, CSA file LR10990.

Terminal	Function	Rocker	Body	Finish	Body Colour	Rocker Colour
<b>C</b> 	<b>Standard 1550</b> <b>1551</b> HP rating N/A		<b>A</b> Softline Matt 	<b>M</b> Matt	<b>B</b> Black	Un-Lit <b>B</b> Black
<b>H</b> 	<b>1552</b> HP rating N/A		<b>B</b> 	<b>G</b> Gloss	<b>W</b> White	<b>R</b> Red
<b>K</b> 	<b>1553</b> Not W, X or B rocker		<b>L</b> 	Applies to both Rocker & Body		Lit <b>A</b> Amber
<b>T</b> 	<b>1560 µ</b> <b>1561 µ</b> HP rating N/A		<b>V</b> Curved Matt or Gloss 			
<b>U</b> 	<b>1562 µ</b> In house tests only		<b>P</b> Lit window Matt 			<b>C</b> Clear
<b>X</b> 	<b>1570 µ</b> 125V & 250V 1/2 HP H terminal rated T100 only H terminal rated T100 only					<b>R</b> Red
	<b>1571 µ</b> HP rating N/A H terminal rated T100 only					
	<b>1572 µ</b> HP rating N/A H terminal rated T100 only					
	<b>High Inrush 1350</b> Not W, X or B rocker					
	<b>1353</b> Not W, X or B rocker					

### Splash Resistance

 **In house test:**  
20A 24Vdc— Indicative rating only

BioCote antimicrobial additive. Independently verified to ISO22196:2007.

3mm contact gap except if marked  $\mu$ .



**1350 High inrush, positive break switching**  
The 1350 series mechanism ensures contact welds formed at switch-on are positively separated by the plunger tube acting directly on the step in the moving contact.

### Dimensions

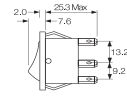

**Panel thickness**  
G, H 0.75 to 2.5mm

Terminal spacing - Poles 10.2 between centres

\* For cut-out details on momentary switches call sales

Insert Colour	Lamp Voltage	Legend	Legend Colour	Options	Biocote
Blank	Blank	Blank	Blank	<p><b>Finish</b> Matt is standard.</p> <p><b>Colour</b> Call sales for custom colours. A full range is available for large orders.</p> <p><b>Legend printing</b> Select from the examples or call sales for custom legends.</p> <p><b>Lamp voltage</b> Call sales for details.</p> <p><b>BioCote Antimicrobial Additive</b>  Moulded components have antimicrobial properties using BioCote silver ion technology.</p>	<b>B</b> Biocote
<b>R</b> Red	<b>2</b> 125V Neon	<b>602A</b>	<b>B</b> Black		
<b>W</b> White	<b>3</b> 250V Neon				
	<b>5</b> 12Vdc LED (P Rocker)		<b>W</b> White		
	<b>6</b> 24Vdc LED (P Rocker)				
	<b>7</b> 12V Filament				
	<b>8</b> 24Vdc Filament				

### Examples



 C1553AH - - -



 C1550AH - - -

# R13 Round Rocker Switches

10A 250Vac



## Key Features

- Miniature round rocker switch
- Ratings up to 10A, 250Vac
- Single & double pole
- Illuminated & nonilluminated, neon and LED
- Choice of actuators
- Matching indicator
- Panel cut out: 20.2 dia.

## Approvals and specifications

☑ SP 10(4)A 250Vac T85 1E4

☑ DP 10(4)A 250Vac T85 1E4

UL CSA SP 16A 125Vac & 10A 250Vac  
 UL CSA DP 16A 125Vac, 10A 250Vac, 10A 28Vdc  
 UL 85°C, file E67774(S), CSA file LR45128

### RoHS compliant

Single pole has  $\mu$  contact gap.

### Special products

Are made to order and can be supplied with a range of body and rocker / lens colours, print & lamp voltage.

## Dimensions

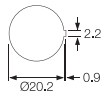

Snap fixing into panel thickness up to 3.0

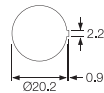

Snap fixing into 2.0 to 3.0mm panels

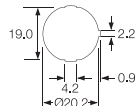

Snap fixing into 0.7 to 3.0mm panels

### Single Pole

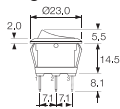

### Double Pole

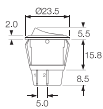

### Protective cover L188



Snaps on to bodies (not R13 211 or R13 112LP), this reduces maximum acceptable panel thickness to 2.4mm.

## Examples



R13 112B NAA



R13 112A AAA



R13 112A2 ---

**R13 / 112 / A / B / B / 3 / 2 / 602A / W / L188**

Series

Type

Function

Body Colour

Rocker Colour

Insert Colour

Lamp Voltage

Legend

Legend Colour

Legend Colour

## Product details



  
 SP ON - OFF μ  
**Cat no.**  
**R13 112A AAA**



  
 SP ON - OFF μ  
 Lit 230V  
**Cat no.**  
**R13 112B NAC**



  
 SP ON - OFF μ  
 Bright colour ON signal  
**Cat no.**  
**R13 112A2 - -**

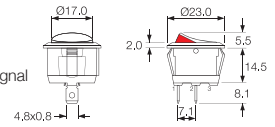

  
 SP ON - OFF μ  
**Cat no.**  
**R13 112A AAB**



  
 SP ON - ON μ  
**Cat no.**  
**R13 112C AAA**



  
 SP ON - OFF μ  
 Lit Window  
**Cat no.**  
**R13 112B2 - -**

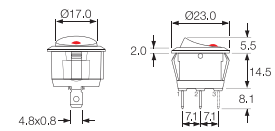

  
 SP ON - OFF μ  
 Lit 230V  
**Cat no.**  
**R13 112B NAA**



  
 SP ON - OFF - ON μ  
**Cat no.**  
**R13 112D AAA**



  
 12  
 SP ON - OFF μ  
 Paddle tip has red LED  
**Cat no.**  
**R13 112LP - -**

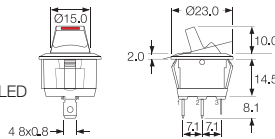

  
 SP ON - OFF μ  
 Lit 230V  
**Cat no.**  
**R13 112B NAB**



SP ON - OFF μ  
 (Momentary ON)  
**Cat no.**  
**R13 208F AAA\***



  
 1 3  
 Indicator light  
**Cat no.**  
**R9 92B - - -**

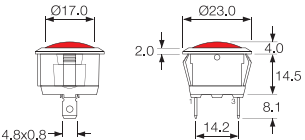

  
 DP ON - OFF  
**Cat no.**  
**R13 244A AAA**



DP ON - OFF  
 Lit 230V  
**Cat no.**  
**R13 244B NAA**

## Toggle Switches

Well known for their quality and reliability, **Bulgin's toggle switches** are **cost effective** solutions to many existing applications. These switches offer features at an attractive price point often well below that of the existing competition.

- Nylon and Metal switch variants
- Multiple Lever Options
- Ratings up to 20A, 250V ac - 277V ac
- IP67 panel seal versions, supplied complete with gaskets (3900 Series – All Variants)
- Single and double pole
- Choice of circuit options including 3 position and momentary
- Mounting hole: 12.7mm diameter.
- Sealing accessories available
- Quick Connect, Solder, Screw and PCB Termination Options

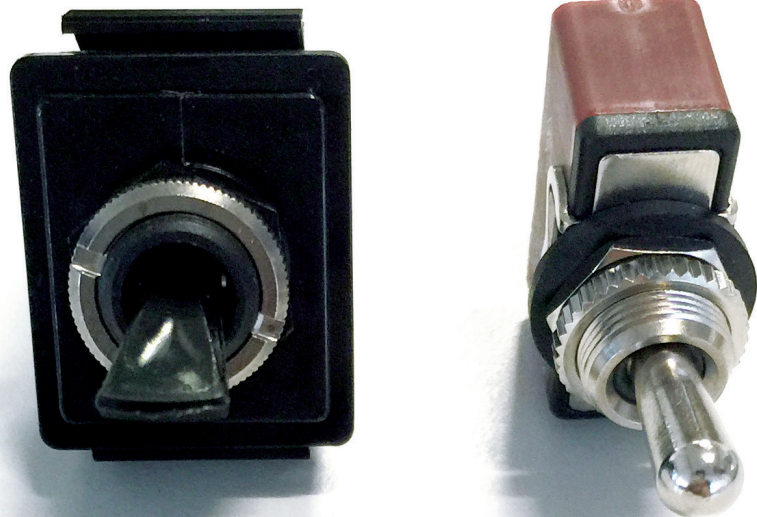

# 3900 Metal Toggle Switches

16A 250Vac - IP67 Sealed Versions



## Key Features

- Metal toggle switches
- Ratings up to 20A, 277V ac
- Single and double pole
- Choice of circuits including 3 position and momentary
- Sealed version supplied complete with gaskets
- Panel seal version to IP67
- 6.3mm terminals
- Guard option



Terminal	Function	Actuator	Body	Options
<p><b>C</b></p> <p>4.8 x 0.8</p>	<p>Single Pole</p> <p><b>3900</b> ON - OFF</p> <p><b>3901</b> ON - OFF (momentary ON)</p> <p><b>3902</b> ON - OFF (momentary OFF)</p>	<p><b>A</b></p> <p>10.0</p> <p>Metal toggle finish is nickel plate</p>	<p><b>A</b> Single pole Thread: 15/32" x 32TPI</p> <p><b>E</b> Panel sealed, single pole Thread: 15/32" x 32TPI</p> <p><b>A</b> Double pole Thread: 15/32" x 32TPI</p> <p><b>B</b> Thread: 15/32" x 32TPI</p> <p><b>F</b> Thread: 15/32" x 32TPI</p> <p>Switches with F toggles have double pole bodies, regardless of circuit</p> <p><b>G</b> Panel sealed, double pole Thread: 15/32" x 32TPI</p>	<p>Neck Seal M539 Actuator is visible</p> <p>Cover M1080</p> <p>Covers have internal nylon nuts</p> <p>M1080-2</p> <p>Covers have internal metal hex nuts</p> <p>Fixing nuts Nickel plated brass are supplied</p> <p>Knurled Front nut Panel thickness 4.0 with backnut</p> <p>Plate P236 Plate SP or DP</p>
<p><b>T</b></p> <p>Ø2.1</p> <p>7.0</p>	<p><b>3910</b> ON - ON</p> <p><b>3911</b> ON - ON (momentary 1 side)</p> <p><b>3920</b> ON - OFF - ON μ</p> <p><b>3921</b> ON - OFF - ON μ (momentary 1 side)</p> <p><b>3922</b> ON - OFF - ON μ (momentary 2 sides)</p>	<p><b>B</b></p> <p>17.5</p> <p>Metal toggle finish is nickel plate</p> <p><b>D</b></p> <p>25.4</p> <p><b>E</b></p> <p>38.1</p> <p>Metal toggle finish is nickel plate</p> <p><b>F</b></p> <p>17.5</p> <p>Metal toggle finish is nickel plate</p>	<p><b>S</b></p> <p>9.7</p> <p>Screw &amp; Clamp N/A for assemblies with 3 terminals</p>	

## Approvals and specifications

UL/CSA Ratings 3901, 3902, 3920, 3921, 3922  
 16A, 277Vac  
 1 HP, 250Vac

7A, 72Vdc  
 14A, 36Vdc

3910, 3901, 3952, 3960, 3961, 3970, 3971, 3972  
 16A, 277Vac  
 1 HP, 250Vac  
 1/2 HP, 125Vac  
 7A, 72Vdc  
 14A, 36Vdc

3900, 3950  
 20A, 277Vac  
 1 HP, 250Vac  
 1/2 HP, 125Vac  
 7A, 72Vdc  
 14A, 36Vdc

ENEC Ratings  
 3900, 3901, 3902, 3950, 3952, 3960, 3961  
 16(4)A 250Vac

3910, 3911, 3920, 3921, 3922, 3951, 3970, 3972  
 10 4)A 250Vac

Approvals and ratings vary with function.  
 3mm contact gap except where marked  $\mu$ .

\* CSA approval for A and B bodies only

## Dimensions mm \* Indicates ON position (for ON - OFF switches)

### Single pole

(C terminals shown)

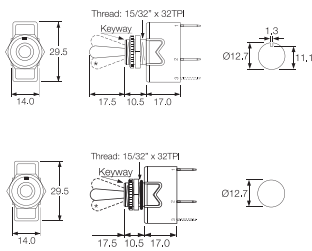

### Double pole

(C terminals shown with barrier)

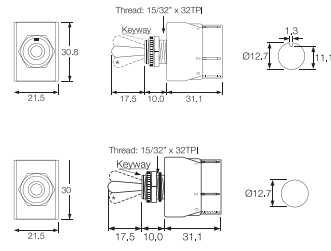

### Toggle Switch - sealed version

BE and BF types

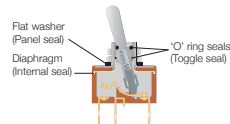

### Guard TG1-RED



## Examples



C3900BE ---



C3920BA ---



C3950BF ---



C3972BB ---



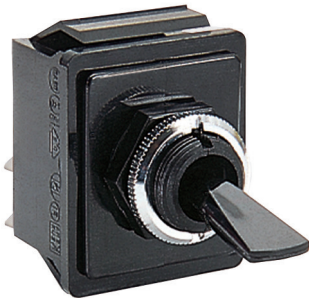

## Key Features

- Nylon toggle switches
- Ratings up to 20A, 250V ac
- Single and double pole
- Wide choice of terminals
- Choice of circuit options including 3 position
- Flat & round actuator options

## Approvals and specifications

16(4)A 250Vac T85

- UL 20A 250Vac Non Ind (Single pole)
- UL 16A 250Vac Non Ind (Double pole)
- UL CSA (2 pos types) 250Vac 1hp, 125Vac 1/2hp
- UL CSA (3 pos types) 250Vac 1/2hp, 125Vac 1/4hp
- CSA 16A 250Vac Non Ind
- UL 85°C, file E45221, CSA file LR10990
- UL and CSA N/A on momentary types

Selective "A, B, C" and "OFF, A, A+B" circuits at 5 amp also available.  
3mm contact gap except where marked  $\mu$ .

Terminal	Function	Actuator	Body	Options
<p><b>C</b></p>	<p>Single Pole</p> <p><b>1700</b> ON - OFF</p>	<p><b>H</b></p>	<p><b>O</b> Single pole</p> <p>Thread: 15/32" x 32TPI</p>	<p>Neck Seal M539</p> <p>Material - Nitrile (H &amp; R Actuators) Actuator visible</p>
<p><b>H</b></p>	<p>Double Pole</p> <p><b>1750</b> ON - OFF</p>			<p>Cover M1080</p> <p>Material - EPDM (R Actuator only)</p>
<p><b>K</b></p>	<p><b>1710 <math>\mu</math></b> ON - ON</p>		<p><b>O</b> Double Pole</p> <p>Thread: 15/32" x 32TPI</p>	<p>Cover M531</p> <p>Material - PVC (R Actuator only)</p>
<p><b>T</b></p>	<p><b>1720 <math>\mu</math></b> ON - OFF - ON</p>	<p><b>R</b></p>	<p>Panel hole (all types)</p> <p>Panel thickness (Max) Both nuts - 3.5mm Less backnut - 6.5mm</p>	<p>Fixing nuts (Standard is M506 &amp; T92)</p> <p>T5 Hex brass M506 Hex nylon</p>
<p><b>X</b></p>	<p><b>1721 <math>\mu</math></b> ON - OFF - ON <math>\mu</math> (momentary 1 side)</p>			<p>T92 Knurled brass - slotted</p>
	<p><b>1722</b> ON - OFF - ON <math>\mu</math> (momentary 2 sides)</p>	<p>The switch is on between centre terminals (2 &amp; 5) and the terminals over which the lever is positioned.</p>		<p>M279 Knurled nylon</p>
				<p>Plate P236 Plate SP or DP</p>

## Dimensions

mm) \* Indicates ON position (for ON - OFF switches)

### Single pole

(C terminals shown)

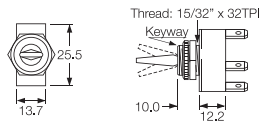

Optional  
F00232PAAA  
plate SP or DP

### Double pole

(C terminals shown)

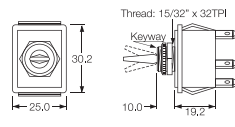

Without barrier

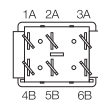

With barrier

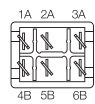

## Examples



C1700R --



C1700H --



C1760R --



C1750H --

Long recognised as a leader in refrigerator door switches, Bulgin's wide range of types and configurations will suit almost any need. With both double pole and single pole options, our switches are not only ideal for traditional refrigerator and freezer applications but can and have been used in a variety of door applications as well.

- Door switches
- Switch rating from 0.2A, 250V ac up to 5A, 250Vac
- Splash resistant variants
- Choice of actuators
- Momentary on and momentary off switching

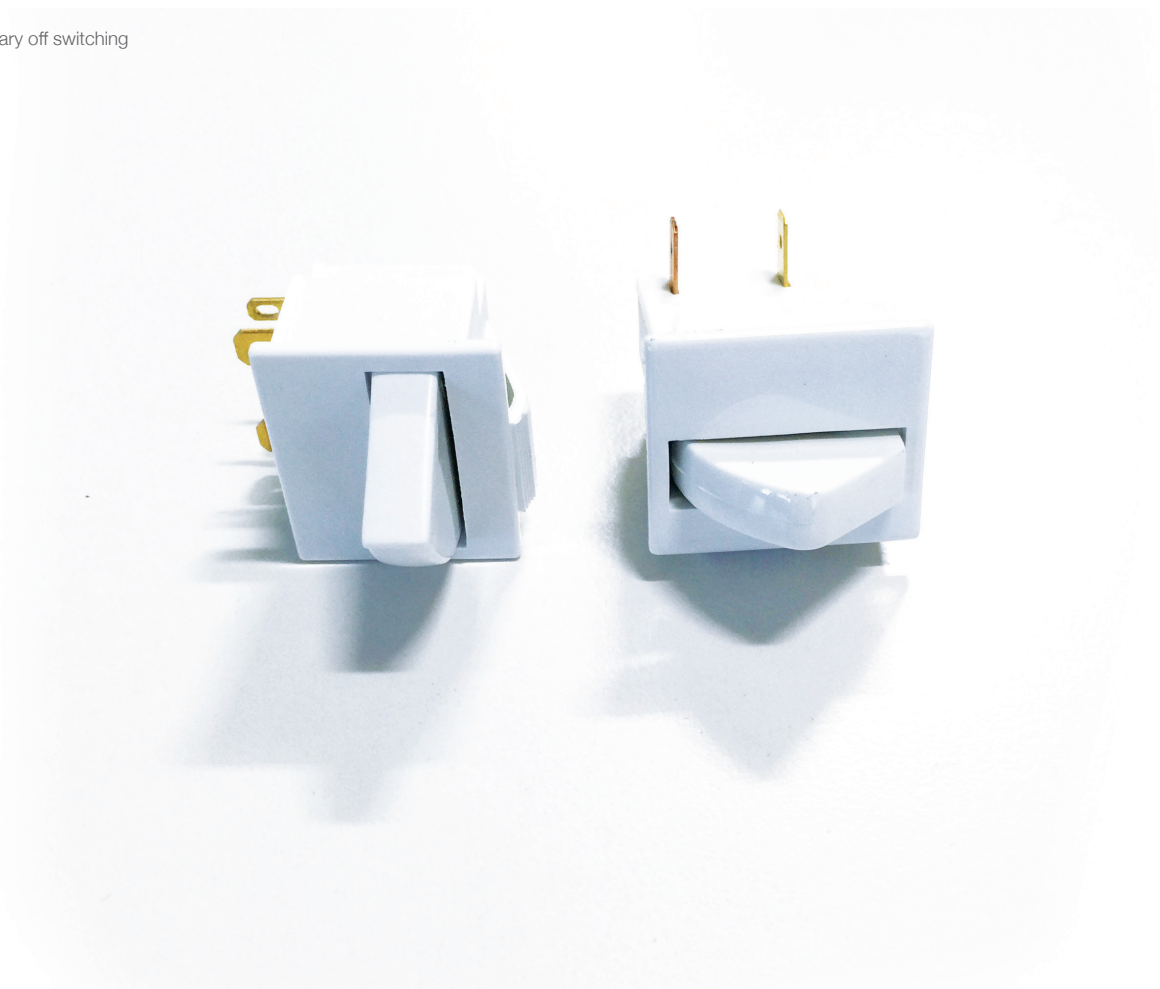

# 0055 Door Switches



## Key Features

- Ratings up to 0.2A, 250V ac
- High temperature rating up to 125°C
- Long overtravel
- Choice of terminal orientation

## Approvals and specifications

☑ 0055 & 0056  
0.2(0.2)A 250Vac 25T125 5E4  
(50,000 operations)

μ contact gap

## Dimensions and Properties

C0055RB

C0056RB

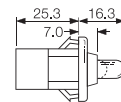
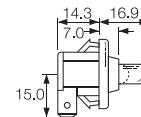

Terminal	Function	Actuator	Body	Options				
<p><b>C</b></p> <p>6.3x0.8</p>	<p><b>0055</b></p> <p>ON - OFF (momentary OFF) 90° terminals</p>	<p><b>R</b></p>	<p><b>B</b></p> <p>Panel cut - out</p> <p>Panel thickness</p> <table border="1"> <tr> <td>0055</td> <td>1.0 - 1.6</td> </tr> <tr> <td>0056</td> <td>1.0 - 2.6</td> </tr> </table> <p>Flange</p>	0055	1.0 - 1.6	0056	1.0 - 2.6	<p><b>Finish</b> Gloss finish only</p> <p><b>Colour</b> White or black Call sales for custom colours.</p>
0055	1.0 - 1.6							
0056	1.0 - 2.6							
<p><b>H</b></p> <p>4.8x0.8</p>	<p><b>0056</b></p> <p>ON - OFF (momentary OFF) straight terminals</p>							

# 3005 Refrigerator Door Switches

Splash Resistant



## Key Features

- Door switches
- Momentary on and momentary off switching
- Splash resistant
- Choice of terminal orientation
- Choice of actuators

## Approvals and specifications

3005 25W 25T85 5E4 (50,000 Operations) 250Vac  
 3006 65W 25T85 5E4 (50,000 Operations) 250Vac

UL 0.3A 250Vac (Black Versions Only)  
 UL 0.2A 125Vac (Black Versions Only)

μ contact gap

## Dimensions and Properties

3005

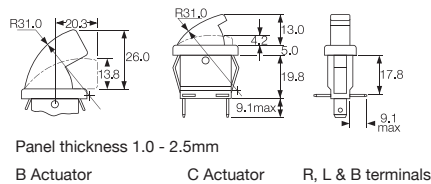

3006

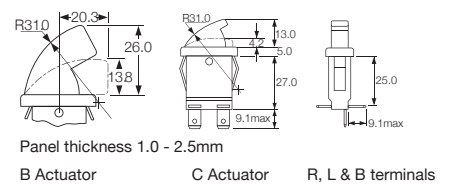

Terminal	Function	Actuator	Body	Options
<p><b>C</b></p> <p>6.3x0.8</p>	<p><b>3005</b></p> <p>ON - OFF (momentary OFF) 1mm max travel to OFF position</p>	<p><b>B</b></p> <p>26.0</p>	<p><b>R      L      B</b></p> <p>Terminal direction (viewed from hinge end)</p> <p>Panel cut - out    Bezel    Bezel Profile</p>	<p><b>Finish</b> Gloss finish only</p> <p><b>Colour</b> White or black Call sales for custom colours. A full range is available for large orders.</p>
<p><b>H</b></p> <p>4.8x0.8</p>	<p><b>3006</b></p> <p>ON - OFF (momentary ON) 3mm min travel to ON position</p>	<p><b>C</b></p> <p>13.0</p>	<p>Panel cut - out    Bezel    Bezel Profile</p>	

# 3100 Refrigerator Door Switches

Splash resistant



E3111BA ---



E3102AA ---

## Key Features

- Door switches
- Ratings up to 5A, 250V ac
- Splash resistant
- Changeover, momentary ON and momentary OFF
- Choice of actuators

## Approvals and specifications

5A 250Vac 25T85 5E4 (50,000 Operations)

UL CSA 5A 250Vac  
UL 85°C, file E45221, CSA file LR10990

μ contact gap.  
Sealed terminals option available.

## Dimensions and Properties

3101 uses terminals 1,2  
3102 uses terminals 1,2  
3111 uses terminals 1,2,3

For details of actuator travel and switching angles call sales.

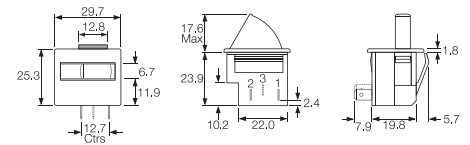

Terminal	Function	Actuator	Body	Colour	Options
<b>C</b> 	 <b>3101</b>  ON - OFF (momentary OFF)	<b>A</b>  <b>B</b>  <b>C</b>  <b>D</b> 	<b>A</b> 	<b>W</b> White  <b>B</b> Black  <b>PW</b> Polar White	Finish Gloss finish only  Colour White or black Call sales for custom colours. A full range is available for large orders.

# 3140 Refrigerator Door Switches

Splash resistant



HK3141AA - - -



H3145AA - - -

## Key Features

- Door switches
- Ratings up to 5A, 250V ac
- Splash resistant
- Momentary action
- Choice of actuators
- 2 circuit switch

## Approvals and specifications

5A 250Vac 25T85 5E4 (50,000 Operations)

UL CSA 5A 250Vac  
UL 85°C, file E45221, CSA file LR10990

3141,  $\mu$  contact gap.  
3145 and 3146, 3mm contact gap.

Sealed terminals option available.

## Dimensions and Properties

3141 uses terminals  
1,2,3,4  
3145 uses terminals 3,4  
3146 uses terminals 1,2

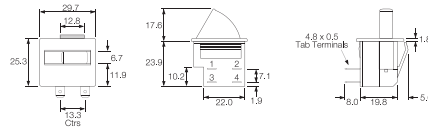

Terminal	Function	Actuator	Body	Colour	Options
<p><b>H</b></p> <p>4.8x0.8</p>	<p><b>3141</b></p> <p>ON - OFF (momentary)</p>	<p><b>A</b></p> <p>17.6 max</p> <p><b>B</b></p> <p>15.6 max</p>	<p><b>A</b></p>	<p><b>W</b></p> <p>White</p> <p><b>B</b></p> <p>Black</p> <p><b>PW</b></p> <p>Polar White</p>	<p><b>Finish</b> Gloss finish only</p> <p><b>Colour</b> White or black Call sales for custom colours. A full range is available for large orders.</p> <p>Order as: 3151 (3141 type) 3155 (3145 type) 3156 (3146 type)</p>
<p><b>K</b></p> <p>2.8x0.8</p>	<p><b>3145</b></p> <p>ON - OFF (momentary OFF)</p>	<p><b>C</b></p> <p>23.0 max</p> <p><b>D</b></p> <p>17.1 max</p>			

Standard format is H terminals in positions 1 & 2 and K terminals in positions 3 & 4. For sealed terminals call sales.

# 0305 Combined Switch / Lampholder for Freezers

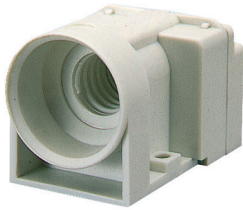

C0305RT ---  
C0305LT ---

## Key Features

- E12 and E14 lamps
- Switch rating up to 0.06A, 250V ac
- Auto switching
- Mercury free
- Available with right or left hand orientation
- Available as lampholder only

## Approvals and specifications

0.06A 250Vac 25 T 85 (0305 only)

UL 15W 125/250Vac (0305 only)  
UL 65°C, file E116391 (0305 only)

Switched units have  $\mu$  contact gap.

## Dimensions and Properties

The mechanism of this switch/lampholder does not contain mercury and may be safely used in food storage equipment. When fitted to the lid of a freezer storage cabinet, the switch will operate the lamp when the lid is opened to the angle of tilt shown in the drawing.

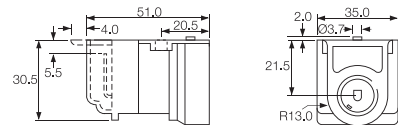

Terminal	Function	Mounting	Body	Options
<p><b>C</b></p>	<p><b>0305 (E14)</b></p> <p>ON - OFF Switch and Lampholder</p>	<p><b>L</b> (View from the bulb end)</p> <p>For Left hinged lid for 0305/0306 switches, not for 0307 lampholder</p>	<p><b>T</b> Body without flange for 0305/0306 switches</p>	<p><b>Colour</b> Call sales for colours. A full range is available for large orders.</p>
<p><b>H</b></p>	<p><b>0306 (E12)</b></p> <p>Lampholder only (No Switch)</p>	<p><b>R</b> (View from the bulb end)</p> <p>For Right hinged lid for 0307 lampholder or 0305/0306 switches</p>	<p><b>S</b> Body with rear flange for 0307 lampholder and for 0305/0306 switches</p>	



With up to 5 switching positions as well as multiple terminal, circuit and slider options, Bulgin's board mounted power slide switches can be configured to suit your needs. We also offer a wide range of voltage selector types that can be either snapped into a panel or flange mounted.

- Ratings up to 16A, 250V ac
- PCB and solder terminals
- Voltage Selector Models
- Snap in and flange mounting
- 2, 3, 4 and 5 position
- Choice of circuits
- Choice of actuators

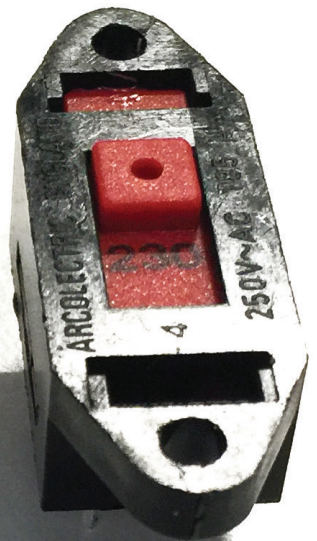
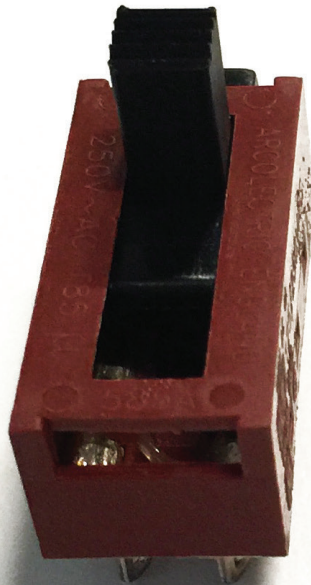

# 2000 Slide Switches - up to 5 position

10A 250Vac

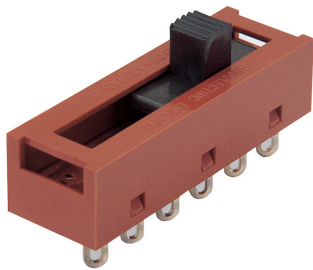

## Key Features

- Slide switches
- Ratings up to 16A, 250V ac
- PCB and solder terminals
- 2, 3, 4 and 5 position
- Choice of circuits
- Choice of actuators

## Approvals and specifications

- ☑ 10A 250Vac T85  
6(3)A 250Vac T85
  - ☑ UL CSA 16A 250Vac Non Inductive  
UL CSA 4A 300Vac  
UL 65°C, file no. E45221, CSA file no. LR10990
- μ contact gap  
Please specify: Standard action (SP116) or Light action (SP118).  
2000 series lubrication is inorganic and does not degrade plastics.

Terminal	Series	Position	Circuit	Slider
<p><b>K</b></p> <p>2.8 x 0.8</p> <p><b>R</b></p> <p>2.8 x 0.8</p> <p><b>T</b></p> <p>Solder</p> <p><b>X</b></p> <p>PCB 0.8 Sq.</p> <p><b>Y</b></p> <p>PCB 0.8 Sq.</p> <p>For mounting stability switches have extra "support" terminals</p> <p>* Nominal - Dimension varies with body type. For exact figure call sales</p>	<p><b>2</b></p>	<p><b>2</b></p> <p>Switching positions</p>	<p><b>10</b></p> <p><b>20</b></p> <p><b>30</b></p> <p><b>40</b></p> <p><b>3</b></p> <p>Switching positions</p> <p><b>10</b></p> <p><b>20</b></p> <p><b>30</b></p> <p><b>40</b></p> <p><b>4</b></p> <p>Switching positions</p> <p><b>10</b></p> <p><b>20</b></p> <p><b>30</b></p> <p><b>40</b></p> <p><b>5</b></p> <p>Switching positions</p> <p><b>10</b></p> <p><b>20</b></p> <p><b>30</b></p> <p><b>40</b></p>	<p><b>0</b></p> <p><b>1</b></p> <p><b>2</b></p> <p><b>3</b></p> <p><b>4</b></p> <p><b>5</b></p> <p><b>6</b></p> <p><b>7</b></p> <p><b>9</b></p> <p><b>A</b></p> <p><b>B</b></p> <p><b>C</b></p> <p><b>D</b></p> <p><b>E</b></p> <p><b>G</b></p> <p><b>H</b></p> <p><b>J</b></p> <p><b>K</b></p> <p><b>L</b></p> <p><b>N</b></p> <p><b>P</b></p> <p><b>R</b></p> <p><b>S</b></p> <p><b>T</b></p>

## Examples

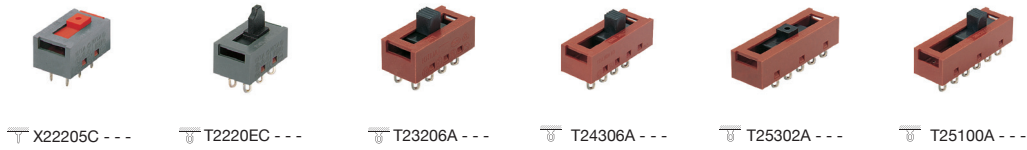

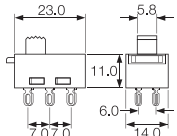
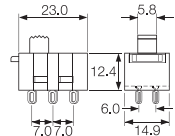
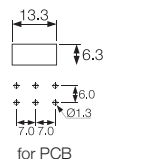
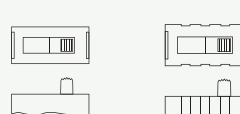
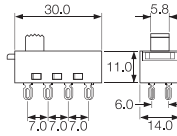
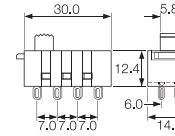
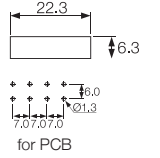
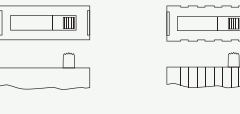
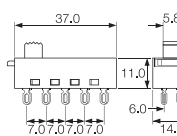
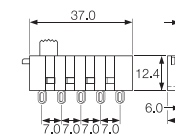
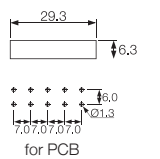
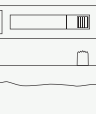
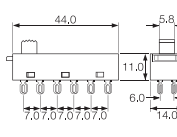
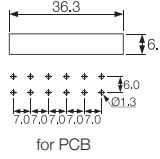
Body		Options	Dimensions		
<p><b>C</b> 2 positions    <b>H</b> 2 positions</p> 	<p><b>Colour</b> Call sales for custom colours. A full range is available for large orders.</p> <p><b>Legend printing</b> A wide range is available. For all options call sales</p>	<p><b>C</b> 2 positions</p> 	<p><b>H</b> 2 positions</p> 	<p><b>Cut-out / PCB Matrix</b></p> 	
<p><b>A</b> 3 positions    <b>H</b> 3 positions</p> 		<p><b>A</b> 3 positions</p> 	<p><b>H</b> 3 positions</p> 		
<p><b>A</b> 4 positions    <b>H</b> 4 positions</p> 		<p><b>A</b> 4 positions</p> 	<p><b>H</b> 4 positions</p> 		
<p><b>A</b> 5 positions</p> 		<p><b>A</b> 5 positions</p> 			

# 2000 Slide Switches - Snap fit and panel mount

10A 250Vac

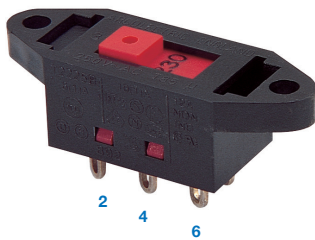

115/230 is preferred legend

## Key Features

- 2 way 'voltage selector'
- Ratings up to 16A, 250V ac
- Snap fit and panel mount
- PCB & solder terminals
- 2 and 3 position
- Choice of circuits
- Choice of actuators

## Approvals and specifications

10A 250Vac T85  
6(3)A 250Vac T85

UL CSA 16A 250Vac Non Inductive  
UL CSA 4A 300Vac  
UL 65°C, file no. E45221, CSA file no. LR10990

μ contact gap

Please specify: Standard action (SP116) or Light action (SP118).

2000 series lubrication is inorganic and does not degrade plastics.

Terminal	Series	Position	Circuit	Slider	
<b>K</b>  2.8 x 0.8	<b>2</b>	<b>2</b> Switching positions	<b>10</b> 	<b>0</b>  <b>6</b>  <b>C</b>  <b>L</b> 	
			<b>20</b> 		<b>2</b>  <b>7</b>  <b>D</b> 
			<b>30</b> 		<b>3</b>  <b>8</b>  <b>E</b> 
			<b>40</b> 		<b>4</b>  <b>9</b>  <b>H</b>  <b>P</b> 
<b>R</b>  2.8 x 0.8	<b>2</b>	<b>2</b> Switching positions	<b>10</b> 	<b>5</b>  <b>A</b>  <b>K</b>  <b>R</b> 	
			<b>20</b> 		<b>S</b>  <b>T</b> 
			<b>30</b> 		<b>40</b> 
			<b>40</b> 		
<b>T</b>  Solder	<b>2</b>	<b>2</b> Switching positions	<b>10</b> 		
			<b>20</b> 		
			<b>30</b> 		
			<b>40</b> 		
<b>X</b>  PCB 0.8 Sq. For mounting stability switches have extra "support" terminals * Nominal - Dimension varies with body type. For exact figure call sales	<b>3</b>	<b>3</b> Switching positions	<b>10</b> 		
			<b>20</b> 		
			<b>30</b> 		
			<b>40</b> 		

## Examples

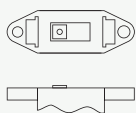
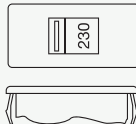
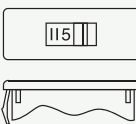

Body	Options
<p><b>B</b> With mounting holes</p> 	<p><b>Colour</b> Call sales for custom colours. A full range is available for large orders. Standard body colour is black.</p>
<p><b>E</b> Snap fit</p> 	
<p><b>F</b> Snap fit (single pole ON OFF only)</p> 	

## Dimensions

### 2 Pos B

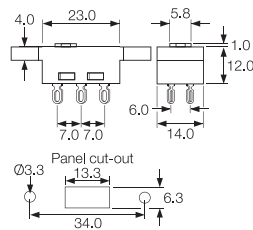

### 3 Pos B

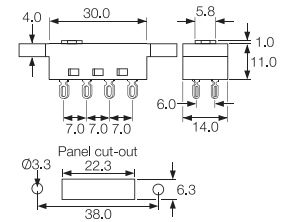

### 2 Pos E

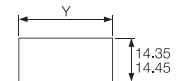
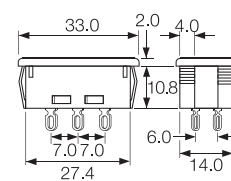

Panel thickness	Dim. Y
0.8-1.2	29.75/29.85
1.63	30.15/30.25
2.0	30.35/30.45
2.5	30.55/30.65

### 2 Pos F

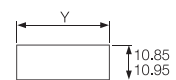
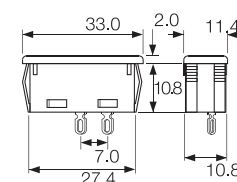

Panel thickness	Dim. Y
0.8-1.2	29.75/29.85
1.63	30.15/30.25
2.0	30.35/30.45
2.5	30.55/30.65

Manufactured from quality moulding and metal components to ensure a secure and reliable connection, Bulgin's battery holder range caters for battery sizes AAA(R03), AA(R6), C(R14), D(R20) and PP3(6R61), accommodating 1, 2, 3 or 4 cells.



There's a choice of fixing styles including screw and flange panel fixing, PCB and base mounting versions.

The panel mounting versions are now available in two styles; standard fixing and front panel sealed to IP67, extending the applications into harsher external environments where dust or water would inhibit equipment operation.

The open frame styles are designed to be either PCB or base mounted and most have an interlocking facility to join adjacent holders together.

Principle applications include portable equipment and memory back-up.

IP67 Sealed	232
Panel Mounting	233-234
PCB/Base Mounting	235-236



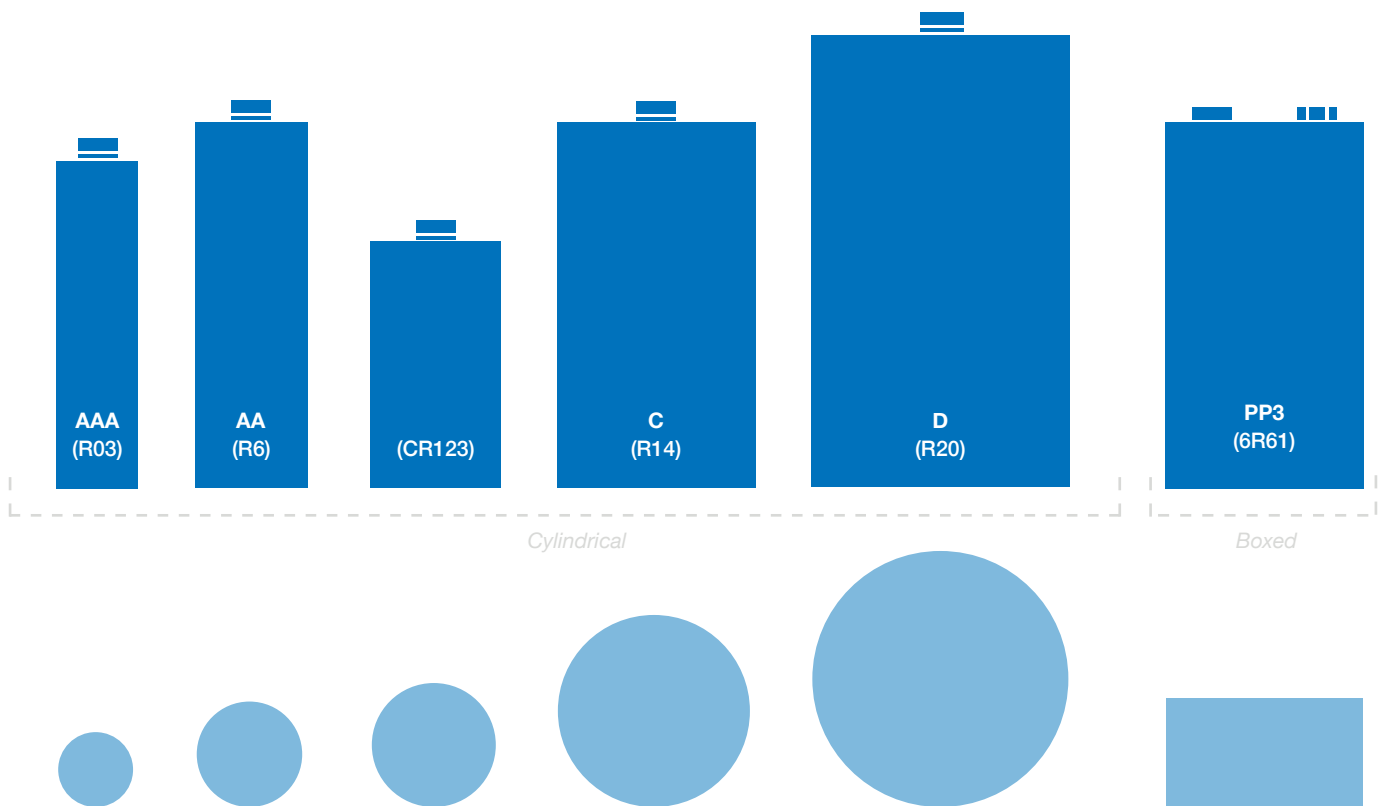

Battery size	Battery Dimensions	No. of Cells	Mounting	Part No.
AAA (R03)	Ø10.5 x 44.5	1	PCB/Base	BX0034
AA (R6)	Ø14.5 x 50.5	1	PCB/Base	BX0035
		1	Panel	BX0011/1
		2	Panel	BX0012/1
		3	Panel	BX0013/1
		4	Panel	BX0027
		1	Panel Sealed	BXS011/1
		2	Panel Sealed Panel	BXS012/1
		3	Sealed	BXS013/1
CR123	Ø17.0 x 34.5	1	PCB/Base	BX0123
C (R14)	Ø26.2 x 50	1	PCB/Base	BX0036
		1	Panel	BX0001/1
		2	Panel	BX0002/1
		3	Panel	BX0003/1
		1	Panel Sealed	BXS001/1
		2	Panel Sealed	BXS002/1
		3	Panel Sealed	BXS003/1
D (R20)	Ø34.2 x 61.5	1	PCB/Base	BX0037
		1	Panel	BX0016
		2	Panel	BX0017
		3	Panel	BX0018
		1	Panel Sealed	BXS016
		2	Panel Sealed	BXS017
		3	Panel Sealed	BXS018
PP3 (6R61)	W26.5 x D17.5 x H48.5	1	PCB/Base	BX0033
		1	Panel	BX0023
		2	Panel	BX0026



As batteries from different manufacturers may vary slightly in size, Dimensions & Drawings are approximate only. All Bulgin Battery Holders have polarity clearly marked.

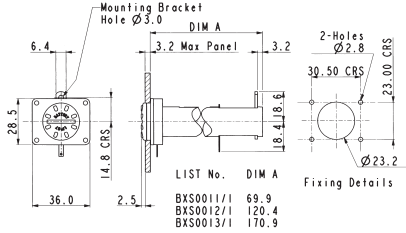

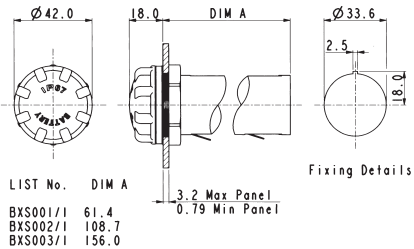

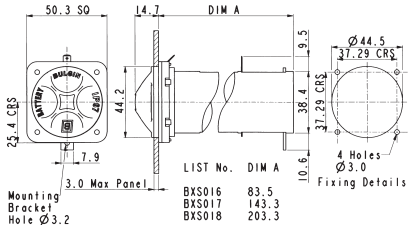
Battery Holders  
**Front panel sealed to IP67**





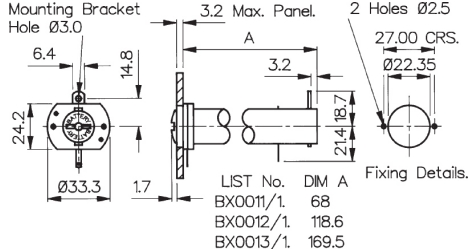

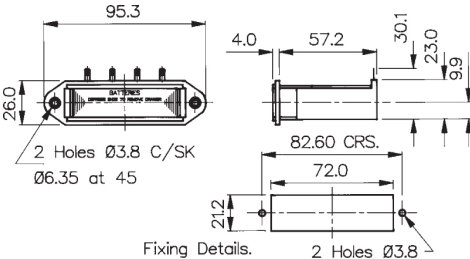
<p>AA SIZE BATTERY HOLDER</p>  <p>BXS011/1</p>	<ul style="list-style-type: none"> <li>○ 1, 2 or 3 Cells</li> <li>○ Flanged Panel Mount</li> <li>○ Bayonet with finger/coin slot release</li> <li>○ Supplied with gasket and sealing grommets for screws</li> </ul>	 <p>LIST No. DIM A</p> <p>BXS0011/1 69.9          BXS0012/1 120.4          BXS0013/1 170.9</p>
<p>C SIZE BATTERY HOLDER</p>  <p>BXS001/1</p>	<ul style="list-style-type: none"> <li>○ 1, 2 or 3 Cells</li> <li>○ Panel Mount</li> <li>○ Screw Cap/Hand release</li> <li>○ Supplied with gasket</li> </ul>	 <p>LIST No. DIM A</p> <p>BXS001/1 61.4          BXS002/1 108.7          BXS003/1 156.0</p>
<p>D SIZE BATTERY HOLDER</p>  <p>BXS016</p>	<ul style="list-style-type: none"> <li>○ 1, 2 or 3 Cells</li> <li>○ Flanged Panel Mount</li> <li>○ Bayonet/finger release</li> <li>○ Supplied with flange gasket and sealing grommets for screws</li> </ul>	 <p>LIST No. DIM A</p> <p>BXS016 83.5          BXS017 143.3          BXS018 203.3</p>

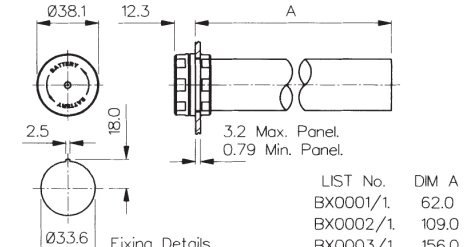
Specification	BXS011/1, BXS012/1, BXS013/1	BXS001/1, BXS002/1, BXS003/1	BXS016, BXS017, BXS018
Battery/Cell Type:	AA (R6)	C (R14)	D (R20)
No. Cells:	BXS011/1 - 1 cell BXS012/1 - 2 cells BXS013/1 - 3 cells	BXS001/1 - 1 cell BXS002/1 - 2 cells BXS003/1 - 3 cells	BXS016 - 1 cell BXS017 - 2 cells BXS018 - 3 cells
Terminations:	2.8 series tabs/solder tags	2.8 series tabs/solder tags	4.8 series tabs/solder tags
Operating Temperature:	-30°C to +70°C	-30°C to +70°C	-30°C to +70°C
Mouldings:	Nylon Glass filled Polyester Polycarbonate	Nylon Glass filled Polyester	Nylon Glass filled Polyester
Flammability Rating:	UL94V-0	UL94V-0	UL94V-0
Contacts:	Brass, Tin Plated - rear contact Nickel Silver, clean - front contact and cap contact plate	Brass, Tin Plated - front and rear contacts Nickel Silver, clean - cap contact plate	Brass, Nickel Plated - front and rear contacts and cap contact plate
Features:	Bayonet cap with finger grip and coin slot Rear support bracket	Screw on cap with finger grip Recommended torque for panel ring 1.13-1.7Nm (10-15lbf.in)	Bayonet cap with finger grip Rear support bracket
Sealing (front of panel):	Protection classification IP67, EN60529:1992+A2:2013	Protection classification IP67, EN60529:1992+A2:2013	Protection classification IP67, EN60529:1992+A2:2013
Notes:	Recommend 2 & 3 cell versions are supported by rear bracket		Recommend 2 & 3 cell versions are supported by rear bracket
RoHS	Compliant	Compliant	Compliant

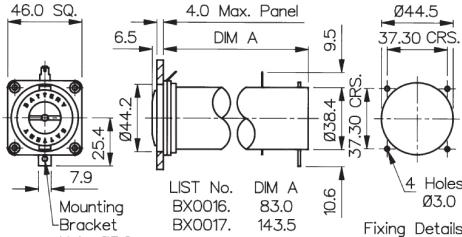

<p>AA SIZE BATTERY HOLDER</p>  <p>BX0011/1</p>	<ul style="list-style-type: none"> <li>○ 1, 2 or 3 Cells</li> <li>○ Flanged Panel Mount</li> <li>○ Bayonet/Screwdriver release</li> </ul>	 <p>Mounting Bracket Hole <math>\varnothing 3.0</math></p> <p>3.2 Max. Panel</p> <p>2 Holes <math>\varnothing 2.5</math></p> <p>27.00 CRS.</p> <p><math>\varnothing 22.35</math></p> <p>6.4</p> <p>14.8</p> <p>A</p> <p>3.2</p> <p>21.4</p> <p>18.7</p> <p>1.7</p> <p><math>\varnothing 33.3</math></p> <p>LIST No. DIM A</p> <p>BX0011/1. 68</p> <p>BX0012/1. 118.6</p> <p>BX0013/1. 169.5</p> <p>Fixing Details.</p>
<p>AA SIZE BATTERY HOLDER</p>  <p>BX0027</p>	<ul style="list-style-type: none"> <li>○ 4 Cells</li> <li>○ Flanged Panel Mount</li> <li>○ Drawer function</li> </ul>	 <p>95.3</p> <p>4.0</p> <p>57.2</p> <p>30.1</p> <p>23.0</p> <p>9.9</p> <p>26.0</p> <p>2 Holes <math>\varnothing 3.8</math> C/SK</p> <p><math>\varnothing 6.35</math> at 45</p> <p>82.60 CRS.</p> <p>72.0</p> <p>21.2</p> <p>Fixing Details.</p> <p>2 Holes <math>\varnothing 3.8</math></p>
<p>C SIZE BATTERY HOLDER</p>  <p>BX0001/1</p>	<ul style="list-style-type: none"> <li>○ 1, 2 or 3 Cells</li> <li>○ Panel Mount</li> <li>○ Screw Cap/Hand release</li> </ul>	 <p><math>\varnothing 38.1</math></p> <p>12.3</p> <p>A</p> <p>2.5</p> <p>18.0</p> <p>3.2 Max. Panel</p> <p>0.79 Min. Panel</p> <p>LIST No. DIM A</p> <p>BX0001/1. 62.0</p> <p>BX0002/1. 109.0</p> <p>BX0003/1. 156.0</p> <p>Fixing Details.</p>

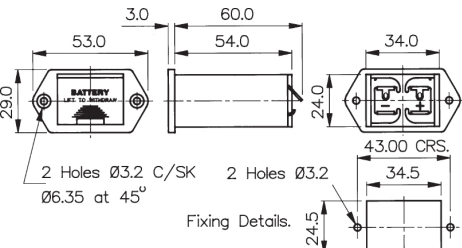
Specification	BX0011/1, BX0012/1, BX0013/1	BX0027	BX0001/1, BX0002/1, BX0003/1
Battery/Cell Type:	AA (R6)	AA (R6)	C (R14)
No. Cells:	BX0011/1 - 1 cell BX0012/1 - 2 cells BX0013/1 - 3 cells	4 cells	BX0001/1 - 1 cell BX0002/1 - 2 cells BX0003/1 - 3 cells
Terminations:	2.8 series tabs/solder tags	4 solder tags (can be wired in series or in pairs)	2.8 series tabs/solder tags
Operating Temperature:	-30°C to +70°C	-30°C to +70°C	-30°C to +70°C
Flammability Rating:	UL94V-0	UL94HB	UL94V-0
Mouldings:	Glass Filled Nylon & Polyester	Glass Filled Nylon	Nylon & Glass Filled Nylon
Contacts:	Brass, Tin Plated Nickel Silver, clean	Phosphor Bronze, Tin Plated Nickel Silver, clean	Nickel Silver, clean Brass, Tin Plated
Features:	Bayonet cap with coin slot Rear support bracket	Removable loading/latching drawer	Screw on cap. Recommended torque for panel ring 1.13-1.7Nm (10-15lb.in)
Notes:	Recommend 2 & 3 cell versions are supported by rear bracket		
RoHS	Compliant	Compliant	Compliant

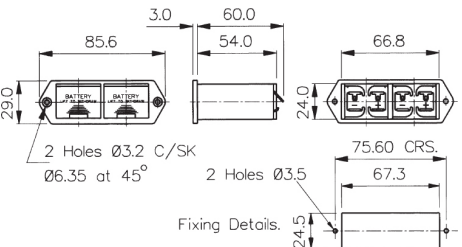
<p>D SIZE BATTERY HOLDER</p>  <p style="text-align: right;"><b>BX0016</b></p>	<ul style="list-style-type: none"> <li>○ 1, 2 or 3 Cells</li> <li>○ Flanged Panel Mount</li> <li>○ Bayonet/Screwdriver release</li> </ul>	 <p>LIST No. DIM A          BX0016. 83.0          BX0017. 143.5          BX0018. 204.0</p>
<p>PP3 SIZE BATTERY HOLDER</p>  <p style="text-align: right;"><b>BX0023</b></p>	<ul style="list-style-type: none"> <li>○ 1 Cell</li> <li>○ Flanged Panel Mount</li> <li>○ Drawer function</li> </ul>	
<p>PP3 SIZE BATTERY HOLDER</p>  <p style="text-align: right;"><b>BX0026</b></p>	<ul style="list-style-type: none"> <li>○ 2 Cell</li> <li>○ Panel Mount</li> <li>○ Screw Cap/Hand release</li> </ul>	

Specification	BXS011/1, BXS012/1, BXS013/1	BX0023	BX0026
Battery/Cell Type:	D (R20)	PP3 (6R61)	PP3 (6R61)
No. Cells:	BX0016 - 1 cell BX0017 - 2 cells BX0018 - 3 cells	1 cell	2 cells
Terminations:	4.8 series tabs/solder tags	Solder tag	Solder tags
Operating Temperature:	-30°C to +70°C	-30°C to +70°C	-30°C to +70°C
Flammability Rating:	UL94V-0	UL94HB	UL94HB
Mouldings:	Nylon & Polycarbonate	Glass Filled Nylon	Glass Filled Nylon
Contacts:	Brass, Nickel Plated	Phosphor Bronze, Tin Plated	Phosphor Bronze, Tin Plated
Features:	Bayonet cap with coin slot Rear support bracket	Removable loading drawer	Removable loading drawer
Notes:	Recommend 2 & 3 cell versions are supported by rear bracket		
<b>RoHS</b>	Compliant	Compliant	Compliant

CR123 SIZE BATTERY HOLDER

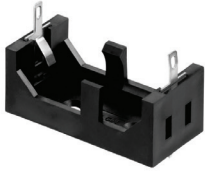

BX0123

- 1 Cell
- PC/Base Mount
- Open style

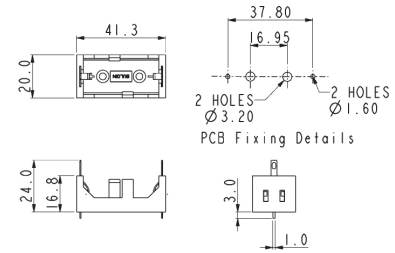

AAA SIZE BATTERY HOLDER



BX0034

- 1 Cell
- PC/Base Mount
- Open style

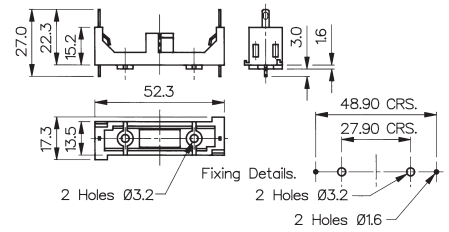

AA SIZE BATTERY HOLDER

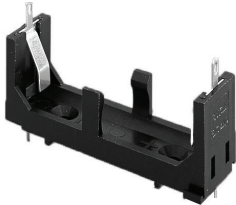

BX0035

- 1 Cell
- PC/Base Mount
- Open style

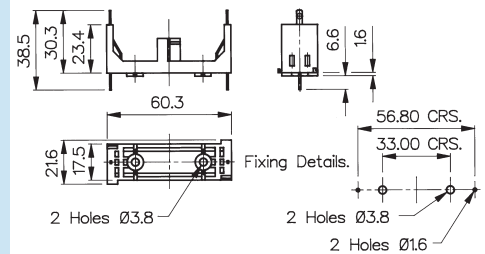





Specification

BX0123

BX0034

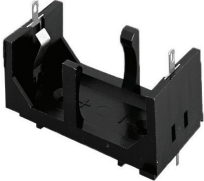
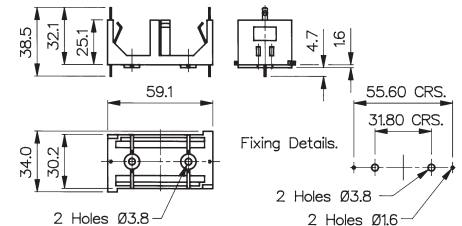
BX0035

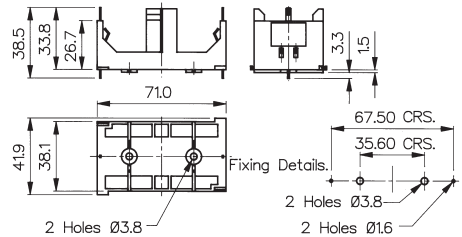
Battery/Cell Type:	CR123	AAA (R03)	AA (R6)
No. Cells:	1 cell	1 cell	1 cell
Terminations:	Dual connections, P.C. spills & 2.8 series tabs/solder tags. (P.C. spills may be removed if required)	Dual connections, P.C. spills & 2.8 series tabs/solder tags. (P.C. spills may be removed if required)	Dual connections, P.C. spills & 2.8 series tabs/solder tags. (P.C. spills may be removed if required)
Operating Temperature:	-30°C to +70°C	-30°C to +70°C	-30°C to +70°C
Flammability Rating:	UL94HB	UL94HB	UL94HB
Mouldings:	Glass Filled Nylon	Glass Filled Nylon	Nylon & Glass Filled Nylon
Contacts:	Nickel Silver, clean	Nickel Silver, clean	Nickel Silver, clean
Features:		Interlocking for multiple assemblies	Interlocking for multiple assemblies
<b>RoHS</b>	Compliant	Compliant	Compliant

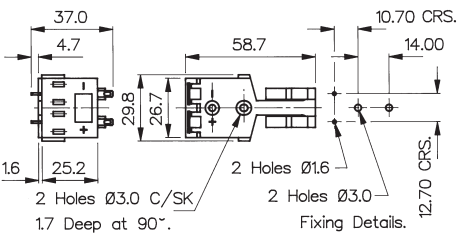
<p>C SIZE BATTERY HOLDER</p>  <p style="text-align: right;"><b>BX0036</b></p>	<ul style="list-style-type: none"> <li>○ 1 Cell</li> <li>○ PC/Base Mount</li> <li>○ Open style</li> </ul>	
<p>D SIZE BATTERY HOLDER</p>  <p style="text-align: right;"><b>BX0037</b></p>	<ul style="list-style-type: none"> <li>○ 1 Cell</li> <li>○ PC/Base Mount</li> <li>○ Open style</li> </ul>	
<p>PP3 SIZE BATTERY HOLDER</p>  <p style="text-align: right;"><b>BX0033</b></p>	<ul style="list-style-type: none"> <li>○ 1 Cell</li> <li>○ PC/Base Mount</li> <li>○ Open style</li> </ul>	

Specification	BX0036	BX0037	BX0033
Battery/Cell Type:	C (R14)	D (R20)	PP3 (6R61)
No. Cells:	1 cell	1 cell	1 cell
Terminations:	Dual connections, P.C. spills & 2.8 series tabs/solder tags. (P.C. spills may be removed if required)	Dual connections, P.C. spills & 2.8 series tabs/solder tags. (P.C. spills may be removed if required)	Dual connections, P.C. spills & 2.8 series tabs/solder tags. (P.C. spills may be removed if required)
Operating Temperature:	-30°C to +70°C	-30°C to +70°C	-30°C to +70°C
Flammability Rating:	UL94HB	UL94HB	UL94HB
Mouldings:	Glass Filled Nylon	Glass Filled Nylon	Nylon & Glass Filled Nylon
Contacts:	Nickel Silver, clean	Nickel Silver, clean	Nickel Silver, clean
Features:	Interlocking for multiple assemblies	Interlocking for multiple assemblies	
<b>RoHS</b>	Compliant	Compliant	Compliant

A full range of **quality** mains rated **inlets, outlets** and **connectors** conforming to **IEC** and EN 60320 specifications carrying **UL, CSA, VDE** and other approvals.

With electrical ratings up to 20A, 250V (UL) these connector ranges offer solutions to most mains powered equipment and cable applications.

The combinations of mounting styles and terminations include: flange fixing, snap to panel and PCB mounting versions together with 2.8/ solder tabs, 4.8 and 6.3 fast on tabs, screw terminal and PC spill versions.

Completing the range are insulating boots, retaining and safety covers

In addition to the standard black moulding, most styles are also available in either white or grey and special colours to match OEM equipment can also be supplied. (Subject to product approval requirements)

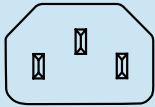
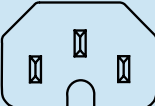
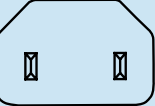
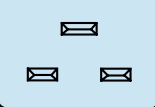

Inlets and Outlet Connectors	238-262
Distribution Units	263-267
Power Entry Modules	268-290
EMI Mains Filters	291-299

IEC60 320-1	Sheet No:	No Pins	Current Rating	Flange Fixing	Snap fit	Fused Flange	Fused Snap fit	Filtered	Fuse Filtered
	C14	3	10A, 250V a.c.	PX0579 PX0580 PX0580/PC PX0580/PC/12132 PX0580/PC/7 PX0580/PC/7LC	PX0575 PX0575/PC	PF0001 PF0001/PC PF0002 PF0030 PF0030/PC	PF0011 PF0011/PC	PS00 PS01	PS20 PS21 PS25 PS26
	C16	3	10A, 250V a.c.	PX0590	PX0595				
	C18	2	10A, 250V a.c.	PX0690	PX0691 PX0691/PC	PF0006 PF0007	PF0016		
	C20	3	3 16A, 250V a.c.	PX0596	PX0598				

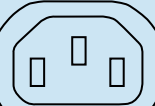
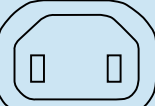
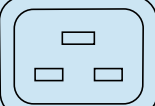
IEC60 320-2-2	Sheet No:	No Pins	Current Rating	Flange Fixing	Snap fit	Fused Flange	Fused Snap fit	Filtered	Fuse Filtered
	F	3	10A, 250V a.c.	PX0675 PX0675/PC PX0675/PC/12599 PX0793 (Shuttered) PX0793/1(Shuttered)	PX0695 PX0695/PC PX0783 (Shuttered) PX0716 PX0717 PX0718				
	H	2	10A, 250V a.c.	PX0705	PX0725				
	J	3	16A, 250V a.c.	PX0591	PX0592				

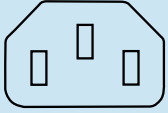
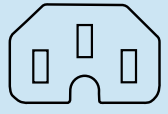
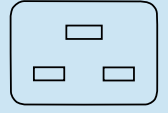
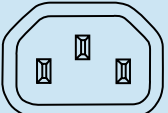
IEC60 320-1	Sheet No:	No Pins	Current Rating	Rewirable	Side Entry Rewirable
	C13	3	10A, 250V a.c.	PX0587 PX0588	PX0587/SE
	C15	3	10A, 250V a.c.	PX0597	
	C19	3	16A, 250V a.c.	PX0599	
IEC60 320-2-2	Sheet No:	No Pins	Current Rating	Rewirable	Side Entry Rewirable
	E	3	10A, 250V a.c.	PX0686	PX0685 PX0686/SE

## Straight Female Connector



PX0587

- Cable Mounting
- Rewirable
- Screw Terminals
- 10A, 250V a.c.

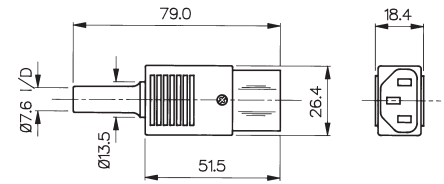

## Side Entry Female Connector



PX0587/SE

- Cable Mounting
- Rewirable
- Screw Terminals
- 10A, 250V a.c.

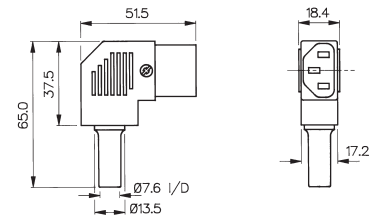





## Angled Female Connector

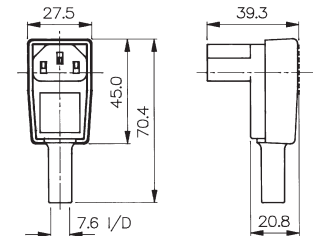

PX0588

- Cable Mounting
- Rewirable
- Screw Terminals
- 10A, 250V a.c.



Specifications	PX0587/Col	PX0587/SE/Col	PX0588
Terminations:	Screw Terminals	Screw Terminals	Screw Terminals
Colours:	No suffix (Black), /WH (White), /GY (Grey)	No suffix (Black), /WH (White), /GY (Grey)	-
Max. Rating:	10A, 250V a.c.	10A, 250V a.c.	10A, 250V a.c.
Contact Resistance:	<10mΩ	<10mΩ	<10mΩ
Insulation Resistance:	>10 <sup>3</sup> MΩ	>10 <sup>3</sup> MΩ	>10 <sup>3</sup> MΩ
A.C. Breakdown:	Pole-Pole 4.5kV. (Poles-Accessible) Parts 4kV	Pole-Pole 4.5kV. (Poles-Accessible) Parts 4kV	Pole-Pole 5kV. (Poles-Accessible) Parts 3.5kV
Operating Temp.	-40°C to +70°C	-40°C to +70°C	-40°C to +70°C
Withdrawal Force:	10N (Min.) 50N (Max.)	10N (Min.) 50N (Max.)	10N (Min.) 50N (Max.)
Mouldings:	Nylon, Flammability Rating UL94V-0	Nylon, Flammability Rating UL94V-0	Nylon, Flammability Rating UL94V-0
Contacts	Brass, Clean	Brass, Clean	Brass, Clean
Approvals:			
Accessories / Notes:	VDE and ENEC approval for black and white versions only.	VDE and ENEC approval for black and white versions only.	
Mating Inlets:	PX0575, PX0579, PX0580, PF0001, PF0011, PF0030, PF0033	PX0575, PX0579, PX0580, PF0001, PF0011, PF0030, PF0033	PX0575, PX0579, PX0580, PF0001, PF0011, PF0030, PF0033
<b>RoHS</b>	Compliant	Compliant	Compliant



## Snap Fit to Panel Inlet



PX0575/10/28

- Fits Panel Sizes 1, 1.5, 2.0 or 3.0mm
- 2.8, 4.8, 6.3mm Tabs or Screw Terminals
- 10A, 250V a.c. (15A, 250V a.c. UL & CSA)

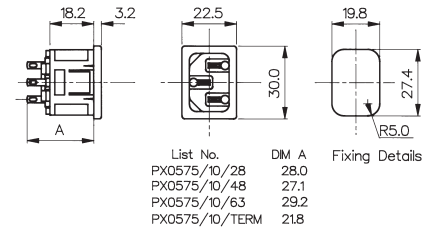

## PC Snap Fit to Panel Inlet



PX0575/10/PC

- Fits Panel Sizes 1, 1.5, 2.0 or 3.0mm
- PC Spills
- 10A, 250V a.c. (15A, 250V a.c. UL & CSA)

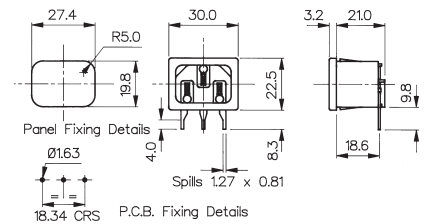

## Specifications

## PX0575/Panel/Term/Col

## PX0575/Panel/PC/Col

Fixing(Panel):	Snap fit, /10 (1mm), /15 (1.5mm), /20 (2mm), /30 (3mm)
Terminations:	/28 (2.8mm solder), /48 (4.8mm tab)
Colours:	No suffix (Black), /WH (White), /GY (Grey)
Max. Rating:	10A, 250V a.c. (UL & CSA 15A, 250V a.c.)
Contact Resistance:	<10mΩ
Insulation Resistance:	>10 <sup>3</sup> MΩ
A.C. Breakdown:	Pole-Pole 5kV. Poles-Panel 5.4kV
Operating Temp. Range:	-40°C to +70°C
Max. Pin Temp.:	+70°C
Mouldings:	Nylon, Flammability Rating UL94V-0
Contacts:	Brass: Pins, Nickel Plated. Tabs, Tin Plated, Screw Terms, Nickel Plated

Fixing(Panel):	Snap fit, /10 (1mm), /15 (1.5mm), /20 (2mm), /30 (3mm)
Terminations:	P.C. Spills
Colours:	No suffix (Black), /WH (White), /GY (Grey)
Max. Rating:	10A, 250V a.c. (UL & CSA 15A, 250V a.c.)
Contact Resistance:	<10mΩ
Insulation Resistance:	>10 <sup>3</sup> MΩ
A.C. Breakdown:	Pole-Pole 5kV. Poles-Panel 5.4kV
Operating Temp. Range:	-40°C to +70°C
Max. Pin Temp.:	+70°C
Mouldings:	Nylon, Flammability Rating UL94V-0
Contacts:	Brass: Pins, Nickel Plated. Spills, Tin Plated

## Approvals:



## Accessories / Notes:

P.No. 11328 (See Page 152)  
 VDE and ENEC approval for black versions only.

Standard without cover.  
 With cover add /C to P.No.  
 PX0587, PX0587/SE, PX0588  
 VDE and ENEC approval for black versions only.

## Mating Connectors:

PX0587, PX0587/SE, PX0588

PX0587, PX0587/SE, PX0588

## RoHS

Compliant

Compliant

## Flange Mount Inlet



PX0580/28

- 2.8, 4.8, 6.3mm Tabs or Screw Terminals
- 10A, 250V a.c. (15A, 250V a.c. UL & CSA)

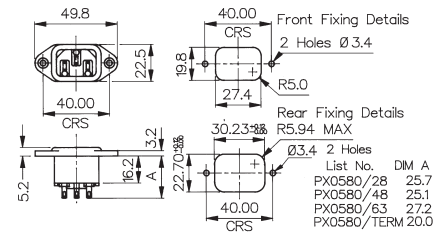



## Vertical Flange Mount Inlet

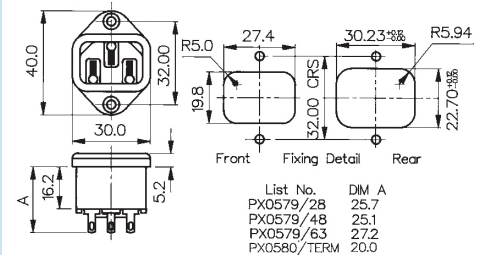

PX0579/28

- 2.8, 4.8, 6.3mm Tabs or Screw Terminals
- 10A, 250V a.c. (15A, 250V a.c. UL & CSA)



Specifications	PX0580/Term/Col	PX0579/Term/Col
Fixing:	Flange	Flange
Terminations:	/28 (2.8mm solder), /48 (4.8mm tab) /63 (6.3mm tab), /TERM (screw)	/28 (2.8mm solder), /48 (4.8mm tab) /63 (6.3mm tab)
Colours:	No suffix (Black), /WH (White), /GY (Grey)	No suffix (Black), /WH (White), /GY (Grey)
Max. Rating:	10A, 250V a.c. (UL & CSA 15A, 250V a.c.)	10A, 250V a.c. (UL & CSA 15A, 250V a.c.)
Contact Resistance:	<10mΩ	<10mΩ
Insulation Resistance:	>10 <sup>3</sup> MΩ	>10 <sup>3</sup> MΩ
A.C. Breakdown:	Pole-Pole 5kV. Poles-Panel 10kV	Pole-Pole 5kV. Poles-Panel 10kV
Operating Temp.:	-40°C to +70°C	-40°C to +70°C
Max. Pin Temp.:	+70°C	+70°C
Mouldings:	Nylon, Flammability Rating UL94V-0	Nylon, Flammability Rating UL94V-0
Contacts:	Brass: Pins, Nickel Plated. Tabs, Tin Plated, Screw Terms, Nickel Plated	Brass: Pins, Nickel Plated. Tabs, Tin Plated
Approvals:		 pending
Accessories / Notes:	P.No. 11328, KT0006 (PX0587 only) (See Pages 150 and 152) VDE and ENEC approval for black versions only.	P.No. 11328 (See Page 152)
Mating Connectors:	PX0587, PX0587/SE, PX0588	PX0587, PX0587/SE, PX0588
<b>RoHS</b>	Compliant	Compliant

## PC Flange Rear Mount Inlet



PX0580/PC

- With or Without Rear Cover
- PC Spills
- 10A, 250V a.c.  
(15A, 250V a.c. UL & CSA)

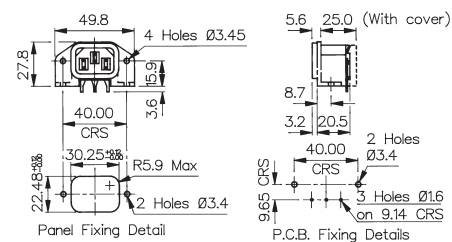

## PC Flange Rear Mount Inlet



PX0580/PC/7

- With or Without Cover
- PC Spills
- 4.8mm Top Tab (earth)
- 10A, 250V a.c.  
(15A, 250V a.c. UL & CSA)

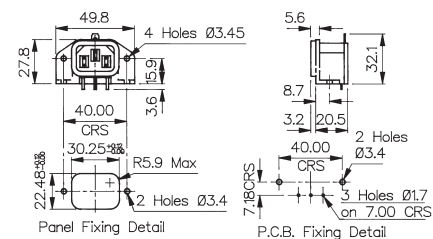

## Specifications

Specifications	PX0580/PC/Col	PX0580/PC/7/Col
Fixing:	P.C.B./Flange	P.C.B./Flange
Terminations:	P.C. Spills	P.C. Spills
Colours:	No suffix (Black), /WH (White), /GY (Grey)	No suffix (Black), /WH (White), /GY (Grey)
Max. Rating:	10A, 250V a.c. (UL & CSA 15A, 250V a.c.)	10A, 250V a.c. (UL & CSA 15A, 250V a.c.)
Contact Resistance:	<10mΩ	<10mΩ
Insulation Resistance:	>10 <sup>9</sup> MΩ	>10 <sup>9</sup> MΩ
A.C. Breakdown:	Pole-Pole 5.4kV. Poles-Panel 10kV	Pole-Pole 5.4kV. Poles-Panel 10kV
Operating Temp. Range:	-40°C to +70°C	-40°C to +70°C
Max. Pin Temp :	+70°C	+70°C
Mouldings:	Nylon, Flammability Rating UL94V-0	Nylon, Flammability Rating UL94V-0
Contacts:	Brass: Pins, Nickel Plated. Spills, Tin Plated	Brass: Pins, Nickel Plated. Spills, Tin Plated
Approvals:		
Accessories / Notes:	Standard without cover. With cover add /12132 to P.No VDE approvals for black version only	Standard without cover. With cover add /12132 to P.No. VDE approvals for black version only
Mating Connectors:	PX0587, PX0587/SE, PX0588	PX0587, PX0587/SE, PX0588
<b>RoHS</b>	Compliant	Compliant

## Flanged Mount Fused Inlet



PF0001/28

PF0002/28

- Single Fuse 5 x 20mm
- Spare Fuse Facility
- 2.8, 4.8 or 6.3mm Tabs
- 10A, 250V a.c.
- Fuse Contacts Isolated (PF0002)

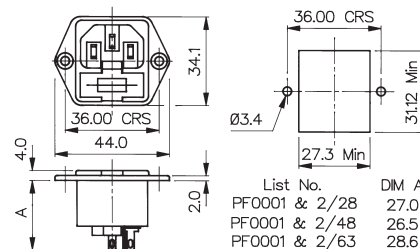





## PC Flanged Mount Fused Inlet

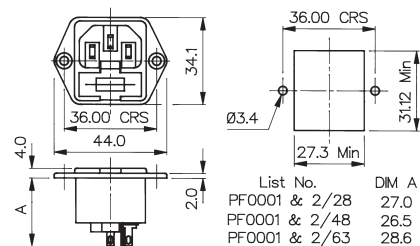

PF0001/PC

- Single Fuse 5 x 20mm
- Spare Fuse Facility
- PC Spills - Horizontal
- 10A, 250V a.c.



Specifications	PF0001/Term/Col	PF0001/PC/Col	PF0002/Term/Col
Fixing(Panel):	Flange	P.C.B./Flange	Flange
Terminations:	/28 (2.8mm solder), /48 (4.8mm tab) /63 (6.3mm tab)	P.C. Spills	/28 (2.8mm solder), /48 (4.8mm tab) /63 (6.3mm tab)
Colours:	No suffix (Black), /WH (White), /GY (Grey)	No suffix (Black), /WH (White), /GY (Grey)	No suffix (Black), /WH (White), /GY (Grey)
Max. Rating:	10A, 250V a.c.	10A, 250V a.c.	10A, 250V a.c.
Max. Fuse Rating:	2.5W/10A, 250V a.c.	2.5W/10A, 250V a.c.	2.5W/10A, 250V a.c.
Contact Resistance:	<10mΩ (<15mΩ including Fuseholder)	<10mΩ (<15mΩ including Fuseholder)	<10mΩ
Insulation Resistance:	>10 <sup>3</sup> MΩ	>10 <sup>3</sup> MΩ	>10 <sup>3</sup> MΩ
A.C. Breakdown:	Pole-Pole 5.5kV. Poles-Panel 4kV	Pole-Pole 5.5kV. Poles-Panel 4kV	Pole-Pole 5.5kV. Poles-Panel 4kV
Operating Temp.:	-40°C to +70°C	-40°C to +70°C	-40°C to +70°C
Max. Pin Temp.:	+70°C	+70°C	+70°C
Mouldings:	Nylon, Flammability Rating UL94V-0	Nylon, Flammability Rating UL94V-0	Nylon, Flammability Rating UL94V-0
Contacts:	Brass: Pins, Nickel Plated. Tabs, Tin Plated	Brass: Pins, Nickel Plated. Tabs, Tin Plated	Brass: Pins, Nickel Plated. Tabs, Tin Plated
Approvals:			
Accessories / Notes:	P.No. 11987, KT0009 See Pages 150 & 152 VDE and ENEC approval for black versions only.	KT0009 (front of panel mounting only) (See Page 150) VDE and ENEC approval for black versions only.	P.No. 11987, KT0009 (See Pages 150 & 152) (Note: Fuse contact isolated) VDE and ENEC approval for black versions only.
Mating Connectors:	PX0587, PX0587/SE, PX0588	PX0587, PX0587/SE, PX0588	PX0587, PX0587/SE, PX0588
<b>RoHS</b>	Compliant	Compliant	Compliant

## Snap Fit to Panel Fused Inlet



PF0011/10/28

- Single Fuse 5 x 20mm
- Spare Fuse Facility
- Panel Sizes 1, 1.5, 2.0 or 3.0mm
- 2.8, 4.8 or 6.3mm Tabs
- 10A, 250V a.c.

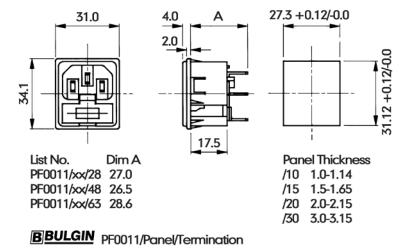



## PC Snap Fit to Panel Fused Inlet

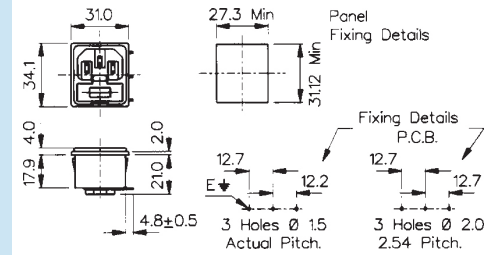

PF0011/10/PC

- Single Fuse 5 x 20mm
- Spare Fuse Facility
- Panel Sizes 1, 1.5, 2.0 or 3.0mm
- PC Spills
- 10A, 250V a.c.



Specifications	PF0011/Panel/Term/Col	PF0011/Panel/PC/Col
Fixing:	Snap fit, /10 (1mm), /15 (1.5mm), /20 (2mm), /30 (3mm)	Snap fit, /10 (1mm), /15 (1.5mm), /20 (2mm), /30 (3mm)
Terminations:	/28 (2.8mm solder), /48 (4.8mm tab) /63 (6.3mm tab)	P.C. Spills
Colours:	No suffix (Black), /WH (White), /GY (Grey)	No suffix (Black), /WH (White), /GY (Grey)
Max. Rating:	10A, 250V a.c.	10A, 250V a.c.
Max. Fuse Rating	2.5W/10A, 250V a.c	2.5W/10A, 250V a.c
Contact Resistance:	<10mΩ (<15mΩ including Fuseholder)	<10mΩ (<15mΩ including Fuseholder)
Insulation Resistance:	>10 <sup>9</sup> MΩ	>10 <sup>9</sup> MΩ
A.C. Breakdown:	Pole-Pole 5.5kV. Poles-Panel 4kV	Pole-Pole 5.5kV. Poles-Panel 4kV
Operating Temp.	-40°C to +70°C	-40°C to +70°C
Max. Pin Temp.:	+70°C	+70°C
Mouldings:	Nylon, Flammability Rating UL94V-0	Nylon, Flammability Rating UL94V-0
Contacts:	Brass: Pins, Nickel Plated. Tabs, Tin Plated	Brass: Pins, Nickel Plated. Spills, Tin Plated
Approvals:		
Accessories / Notes:	P.No. 11987 (See Page 152) VDE and ENEC approval for black versions only.	VDE and ENEC approval for black versions only.
Mating Connectors:	PX0587, PX0587/SE, PX0588	PX0587, PX0587/SE, PX0588
<b>RoHS</b>	Compliant	Compliant

### Flanged Mount Fused Inlet

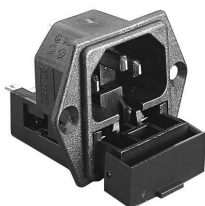

PF0030/28

- Twin Fused 5 x 20mm
- 2.8, 4.8 or 6.3mm Tabs
- 10A, 250V a.c.

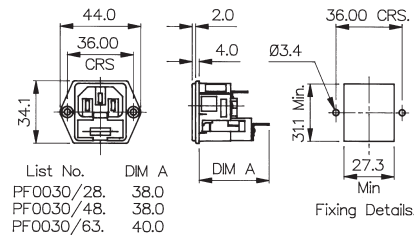

### PC Flanged Mount Fused Inlet



PF0030/PC

- Twin Fused 5 x 20mm
- PC Spills
- 10A, 250V a.c.

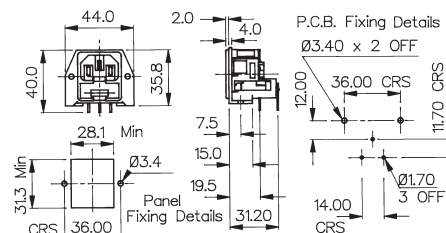

### Snap Fit to Panel Fused Inlet



PF0033/10/28

- Twin Fused 5 x 20mm
- Fits Panel Sizes 1.0, 1.5, 2.0 or 3.0mm
- 2.8, 4.8 or 6.3mm Tabs
- 10A, 250V a.c.

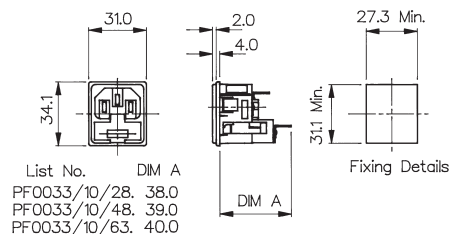

Specifications	PF0030/Termination	PF0030/PC	PF0033/Panel/Termination
Fixing(Panel):	Flange	P.C.B./Flange	Snap fit, /10 (1mm), /15 (1.5mm), /20 (2mm), /30 (3mm)
Terminations:	/28 (2.8mm solder), /48 (4.8mm tab) /63 (6.3mm tab)	P.C. Spills	/28 (2.8mm solder), /48 (4.8mm tab) /63 (6.3mm tab)
Max. Rating:	10A, 250V a.c.	10A, 250V a.c.	10A, 250V a.c.
Contact Resistance:	<15mΩ (per pole)	<15mΩ (per pole)	<15mΩ (per pole)
Insulation Resistance:	>10 <sup>4</sup> MΩ	>10 <sup>4</sup> MΩ	>10 <sup>4</sup> MΩ
A.C. Breakdown:	Pole-Pole 6kV. Poles-Panel 5kV	Pole-Pole 6kV. Poles-Panel 5kV	Pole-Pole 6kV. Poles-Panel 5kV
Max. Dissipation Per Fuse:	2.5W	2.5W	2.5W
Operating Temp.:	-20°C to +70°C	-20°C to +70°C	-20°C to +70°C
Max. Pin Temp.:	+70°C	+70°C	+70°C
Mouldings:	Nylon, Flammability Rating UL94V-0	Nylon, Flammability Rating UL94V-0	Nylon, Flammability Rating UL94V-0
Contacts:	Brass: Pins, Nickel Plated. Tabs, Tin Plated	Brass: Pins, Nickel Plated. Tabs, Tin Plated	Brass: Pins, Nickel Plated. Tabs, Tin Plated
Approvals:			
Accessories / Notes:	KT0009 (See Page 150)		
Mating Connectors:	PX0587, PX0587/SE, PX0588	PX0587, PX0587/SE, PX0588	PX0587, PX0587/SE, PX0588
<b>RoHS</b>	Compliant	Compliant	Compliant

## Straight Female Connector



PX0597

- Cable Mounting
- Hot Condition
- Mates with PX0590 and PX0595
- Screw Terminals
- 10A, 250V a.c.

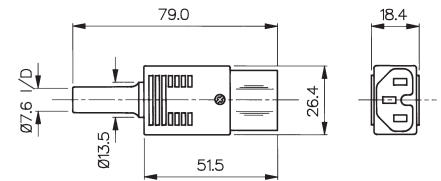

## Flange Mount Inlet



PX0590/28

- Hot Condition
- 2.8 or 6.3mm Tabs
- 10A, 250V a.c.  
(15A, 250V a.c. UL & CSA)

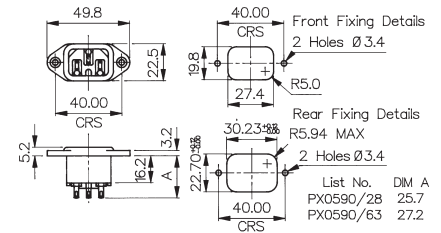





## Snap Fit to Panel Inlet

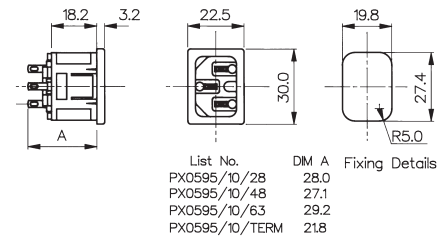

PX0595/10/28

- Hot Condition
- Panel Sizes 1, 1.5, 2.0 or 3.0mm
- 2.8, 4.8, 6.3mm Tabs or Screw Terminals
- 10A, 250V a.c.  
(15A, 250V a.c. UL & CSA)



Specifications	PX0597/Col	PX0590/Term/Col	PX0595/Panel/Term/Col
Fixing(Panel):		Flange	Snap fit, /10 (1mm), /15 (1.5mm), /20 (2mm), /30 (3mm)
Terminations:	Screw Terminals	/28 (2.8mm solder), /63 (6.3mm tab)	/28 (2.8mm solder), /48 (4.8mm tab), /63 (6.3mm tab), /TERM (screw)
Colours:	No suffix (Black), /WH (White), /GY (Grey)	No suffix (Black), /WH (White), /GY (Grey)	No suffix (Black), /WH (White), /GY (Grey)
Max. Rating:	10A, 250V a.c.	10A, 250V a.c. (UL & CSA 15A, 250V a.c.)	10A, 250V a.c. (UL & CSA 15A, 250V a.c.)
Contact Resistance:	<10mΩ	<10mΩ	<10mΩ
Insulation Resistance:	>10 <sup>3</sup> MΩ	>10 <sup>3</sup> MΩ	>10 <sup>3</sup> MΩ
A.C. Breakdown:	Pole-Pole 4.5kV. Poles-Accessible Parts 4kV	Pole-Pole 5kV. Poles-Panel 10kV	Pole-Pole 5kV. Poles-Panel 5.4kV
Operating Temp.	-40°C to +70°C	-40°C to +70°C	-40°C to +70°C
Max. Pin Temp:		+120°C	+120°C
Withdrawal Force:	10N (Min.) 50N (Max.)		
Mouldings:	Nylon, Flammability Rating UL94V-0	Nylon, Flammability Rating UL94V-0	Nylon, Flammability Rating UL94V-0
Contacts:	Brass, Clean	Brass, Pins Nickel Plated. Tabs, Tin Plated	Brass, Pins Nickel Plated. Tabs, Tin Plated
Approvals:			
Accessories / Notes:	VDE and ENEC approval for black and white versions only.	P.No. 11328, KT0006 (See Pages 150 & 152) VDE and ENEC approval for black versions only.	P.No. 11328 (See Page 152) VDE and ENEC approval for black versions only.
Mating Connectors:	PX0590, PX0595	PX0597	PX0597
<b>RoHS</b>	Compliant	Compliant	Compliant

## Flanged Mount Inlet



PX0690/28

- Two Pin Class II (No Earth Pin)
- 2.8, 4.8, 6.3mm Tabs or Screw Terminals
- 10A, 250V a.c. (15A, 250V a.c. UL & CSA)

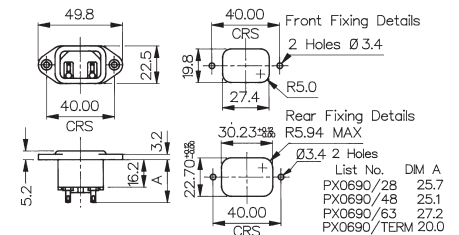

## Snap Fit to Panel Inlet



PX0691/10/28

- Two Pin Class II (No Earth Pin)
- Panel Sizes 1, 1.5, 2.0 or 3.0mm
- 2.8, 4.8, 6.3mm Tabs or Screw Terminals
- 10A, 250V a.c. (15A, 250V a.c. UL & CSA)

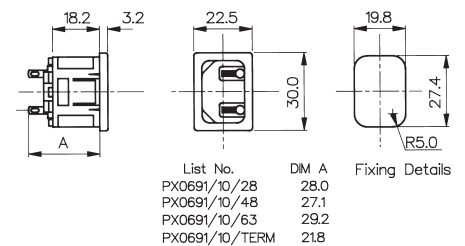





## PC Snap Fit to Panel Inlet

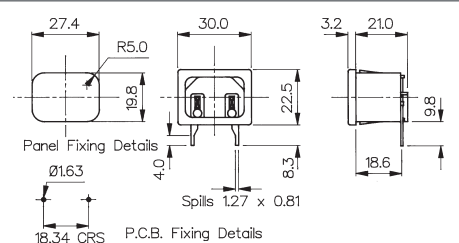

PX0691/10/PC

- Two Pin Class II (No Earth Pin)
- Panel Sizes 1, 1.5, 2.0 or 3.0mm
- PC Spills
- 10A, 250V a.c. (15A, 250V a.c. UL & CSA)



Specifications	PX0690/Term/Col	PX0691/Panel/Term/Col	PX0691/Panel/PC/Col
Fixing(Panel):	Flange	Snap fit, /10 (1mm), /15 (1.5mm), /20 (2mm), /30 (3mm)	Snap fit, /10 (1mm), /15 (1.5mm), /20 (2mm), /30 (3mm)
Terminations:	/28 (2.8mm solder), /48 (4.8mm tab) /63 (6.3mm tab), /TERM (screw)	/28 (2.8mm solder), /48 (4.8mm tab) /63 (6.3mm tab), /TERM (screw)	P.C. Spills
Colours:	No suffix (Black), /WH (White), /GY (Grey)	No suffix (Black), /WH (White), /GY (Grey)	No suffix (Black), /WH (White), /GY (Grey)
Max. Rating:	10A, 250V a.c. (UL & CSA 15A, 250V a.c.)	10A, 250V a.c. (UL & CSA 15A, 250V a.c.)	10A, 250V a.c. (UL & CSA 15A, 250V a.c.)
Contact Resistance:	<10m $\Omega$	<10m $\Omega$	<10m $\Omega$
Insulation Resistance:	>10 <sup>3</sup> M $\Omega$	>10 <sup>3</sup> M $\Omega$	>10 <sup>3</sup> M $\Omega$
A.C. Breakdown:	Pole-Pole 5kV. Poles-Panel 10kV	Pole-Pole 5kV. Poles-Panel 5.4kV	Pole-Pole 5kV. Poles-Panel 5.4kV
Operating Temp. Max. Pin Temp.:	-40°C to +70°C +70°C	-40°C to +70°C +70°C	-40°C to +70°C +70°C
Mouldings:	Nylon, Flammability Rating UL94V-0	Nylon, Flammability Rating UL94V-0	Nylon, Flammability Rating UL94V-0
Contacts:	Brass: Pins, Nickel Plated. Tabs, Tin Plated, Screw Terms, Nickel Plated	Brass: Pins, Nickel Plated. Tabs, Tin Plated, Screw Terms, Nickel Plated	Brass: Pins, Nickel Plated. Spills, Tin Plated
Approvals:			
Accessories / Notes:	P.No. 11328 (See Page 152) VDE and ENEC approval for black versions only.	P.No. 11328 (See Page 152) VDE and ENEC approval for black versions only.	Standard without cover. With cover add /C to P.No. VDE and ENEC approval for black versions only.
Mating Connectors:	PX0587, PX0587/SE, PX0588	PX0587, PX0587/SE, PX0588	PX0587, PX0587/SE, PX0588
<b>RoHS</b>	Compliant	Compliant	Compliant



## Flanged Mount Fused Inlet

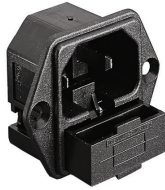

PF0006/28

- Single Fuse 5 x 20mm
- Two Pin Class II (No Earth Pin)
- 2.8, 4.8 or 6.3mm Tabs
- 10A, 250V a.c.

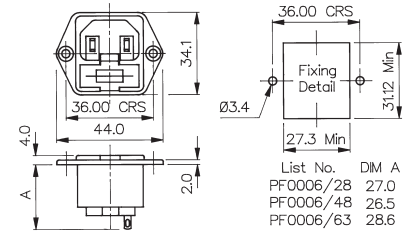

## Flanged Mount Fused Inlet



PF0007/28

- Single Fuse 5 x 20mm (Fuse Contacts Isolated)
- Two Pin Class II (No Earth Pin)
- 2.8, 4.8 or 6.3mm Tabs
- 10A, 250V a.c.

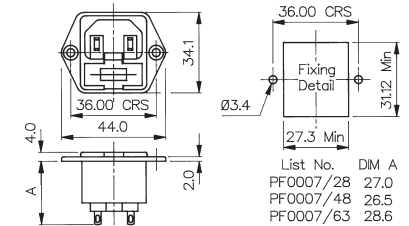





## Snap Fit to Panel Fused Inlet

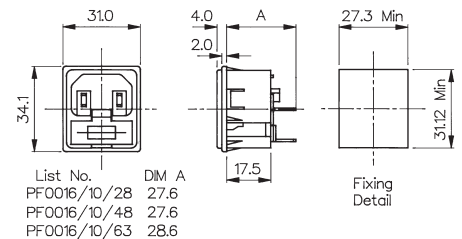

PF0016/10/28

- Single Fuse 5 x 20mm
- Two Pin Class II (No Earth Pin)
- Fits Panel Sizes 1.0, 1.5, 2.0 or 3.0mm
- 2.8, 4.8 or 6.3mm Tabs
- 10A, 250V a.c.



Specifications	PF0006/Term/Col	PF0007/Term/Col	PF0016/Panel/Term/Col
Fixing(Panel):	Flange	Flange	Snap fit, /10 (1mm), /15 (1.5mm), /20 (2mm), /30 (3mm)
Terminations:	/28 (2.8mm solder), /48 (4.8mm tab) /63 (6.3mm tab)	/28 (2.8mm solder), /48 (4.8mm tab) /63 (6.3mm tab)	/28 (2.8mm solder), /48 (4.8mm tab) /63 (6.3mm tab)
Colours:	No suffix (Black), /WH (White), /GY (Grey)	No suffix (Black), /WH (White), /GY (Grey)	No suffix (Black), /WH (White), /GY (Grey)
Max. Rating:	10A, 250V a.c.	10A, 250V a.c.	10A, 250V a.c.
Contact Resistance:	<10mΩ (<15mΩ including Fuseholder)	<10mΩ	<10mΩ (<15mΩ including Fuseholder)
Insulation Resistance:	>10 <sup>9</sup> MΩ	>10 <sup>9</sup> MΩ	>10 <sup>9</sup> MΩ
A.C. Breakdown:	Pole-Pole 5.5kV. Poles-Panel 4kV	Pole-Pole 5.5kV. Poles-Panel 4kV	Pole-Pole 5.5kV. Poles-Panel 4kV
Operating Temp.	-40°C to +70°C	-40°C to +70°C	-40°C to +70°C
Max. Pin Temp.:	+70°C	+70°C	+70°C
Mouldings:	Nylon, Flammability Rating UL94V-0	Nylon, Flammability Rating UL94V-0	Nylon, Flammability Rating UL94V-0
Contacts:	Brass: Pins, Nickel Plated. Tabs, Tin Plated	Brass: Pins, Nickel Plated. Tabs, Tin Plated	Brass: Pins, Nickel Plated. Tabs, Tin Plated
Approvals:			
Accessories / Notes:	P.No. 11987 (See Page 152) VDE and ENEC approval for black versions only.	P.No. 11987 (See Page 152) (Note: Fuse contacts isolated) VDE and ENEC approval for black versions only.	P.No. 11987 (See Page 152) VDE and ENEC approval for black versions only.
Mating Connectors:	PX0587, PX0587/SE, PX0588	PX0587, PX0587/SE, PX0588	PX0587, PX0587/SE, PX0588
<b>RoHS</b>	Compliant	Compliant	Compliant

IEC Connectors  
**EN60 320-2-2 Standard Sheet E Class I**

Rewirable



Angled Male Connector



PX0685

- Cable Mounting
- Four Position Cable Entry
- Rewirable
- Screw Terminals
- 10A, 250V a.c.

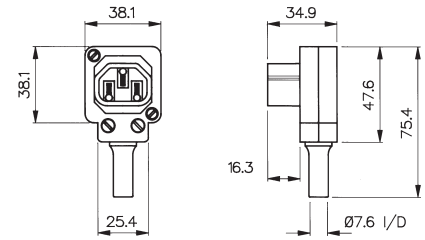

Straight Male Connector



PX0686

- Cable Mounting
- Rewirable
- Screw Terminals
- 10A, 250V a.c.

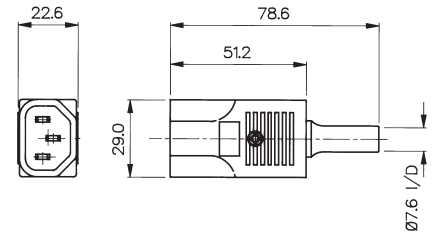

Side Entry Male Connector



PX0686/SE

- Cable Mounting
- Rewirable
- Screw Terminals
- 10A, 250V a.c.

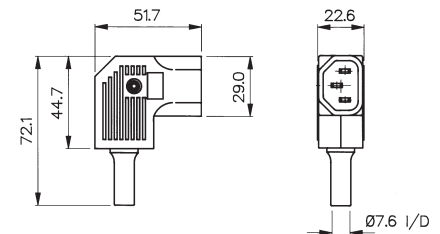

Specifications	PX0685/Col	PX0686/Col	PX0686/SE/Col
Fixing(Panel):	Screw Terminals	Screw Terminals	Screw Terminals
Max. Rating:	10A, 250V a.c.	10A, 250V a.c.	10A, 250V a.c.
Colours:	No suffix (Black), /WH (White), /GY (Grey)	No suffix (Black), /WH (White), /GY (Grey)	No suffix (Black), /WH (White), /GY (Grey)
Contact Resistance:	<10mΩ	<10mΩ	<10mΩ
Insulation Resistance:	>10 <sup>4</sup> MΩ	>10 <sup>4</sup> MΩ	>10 <sup>4</sup> MΩ
A.C. Breakdown:	Pole-Pole 5.2kV. Poles-Accessible Parts 6kV	Pole-Pole 5kV. Poles-Accessible Parts 5kV	Pole-Pole 5kV. Poles-Accessible Parts 5kV
Operating Temp.	-40°C to +70°C	-40°C to +70°C	-40°C to +70°C
Withdrawal Force:	10N (Min.) 50N (Max.)	10N (Min.) 50N (Max.)	10N (Min.) 50N (Max.)
Mouldings:	Nylon, Flammability Rating UL94V-0	Nylon, Flammability Rating UL94V-0	Nylon, Flammability Rating UL94V-0
Contacts:	Brass, Nickel Plated.	Brass, Nickel Plated.	Brass, Nickel Plated.
Approvals:			
Accessories / Notes:	Unique octagon module allows choice of 4 cable positions	VDE and ENEC approval for black and white versions only.	VDE and ENEC approval for black and white versions only.
Mating Outlets:	PX0675, PX0695, PX0578, PX0783, PX0793, PX0793/1	PX0675, PX0695, PX0578, PX0783, PX0793, PX0793/1, PX0716, PX0717 & PX0718	PX0675, PX0695, PX0578, PX0783, PX0793, PX0793/1, PX0716, PX0717 & PX0718
<b>RoHS</b>	Compliant	Compliant	Compliant

## Snap Fit To Panel Two Way Outlet



PX0714/2/15/28

- Panel Size 1.5mm
- 2.8mm Solder Tabs
- 10A, 250V a.c.
- (15A, 250V a.c. UL)
- All Terminals Linked

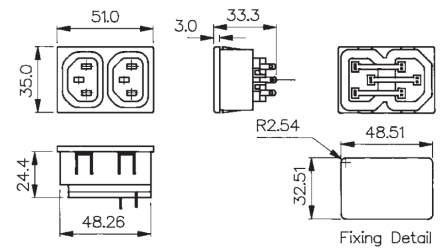

## Snap Fit To Panel Three Way Outlet



PX0741/3/15/28

- Panel Size 1.5mm
- 2.8mm Solder Tabs
- 10A, 250V a.c.
- (15A, 250V a.c. UL)
- All Terminals Linked

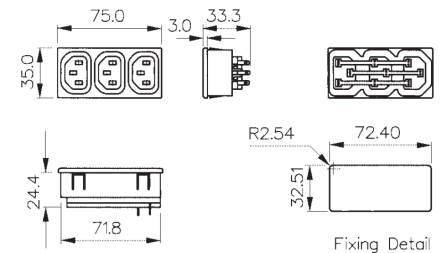





## Snap Fit To Panel Four Way Outlet

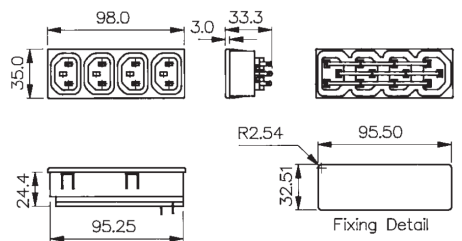

PX0714/4/15/28

- Panel Size 1.5mm
- 2.8mm Solder Tabs
- 10A, 250V a.c.
- (15A, 250V a.c. UL)
- All Terminals Linked



Specifications	PX0714/2/15/28	PX0714/3/15/28	PX0714/4/15/28
Fixing(Panel):	Snap fit /15 (1.5mm)	Snap fit /15 (1.5mm)	Snap fit /15 (1.5mm)
Max. Rating:	10A, 250V a.c. 15A, 250V a.c UL	10A, 250V a.c. 15A, 250V a.c UL	10A, 250V a.c. 15A, 250V a.c UL
Colours:	No suffix (Black)	No suffix (Black)	No suffix (Black)
Operating Temp.	-20°C to +70°C	-20°C to +70°C	-20°C to +70°C
Withdrawal Force:	10N (Min.) 50N (Max.)	10N (Min.) 50N (Max.)	10N (Min.) 50N (Max.)
Mouldings:	Glass filled Thermoplastic, UL94V-0	Glass filled Thermoplastic, UL94V-0	Glass filled Thermoplastic, UL94V-0
Contacts:	Plated Copper Alloy	Plated Copper Alloy	Plated Copper Alloy
Approvals:			
Mating Outlets:	PX0686, PX0686/SE, PZ0500, PZ0600	PX0686, PX0686/SE, PZ0500, PZ0600	PX0686, PX0686/SE, PZ0500, PZ0600
RoHS	Compliant	Compliant	Compliant

Snap Fit to Panel Inlet/ Outlet



PX0716/48

- Inlet/Outlet combination
- Panel Size 1.2mm
- 4.8mm tabs
- 10A, 250V a.c.  
(15A, 250V a.c. UL & CSA)

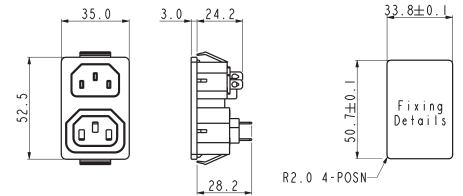



Snap Fit to Fused Inlet/ Outlet

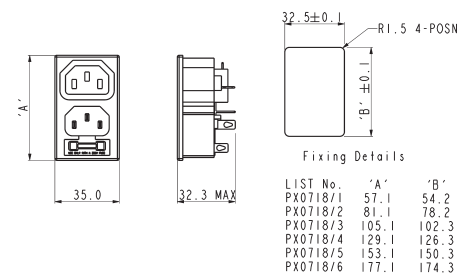

PX0718/x/xx/ST

- Fused Inlet/Outlet combination
- 1-6 outlet versions
- Panel Size 1.5mm
- Terminals:  
inlet: 4.8mm tabs  
outlet: solder tags
- 10A, 250V a.c.  
(15A, 250V a.c. UL)
- All outlet terminals linked,  
common earth throughout.



Specifications	PX0716/Termination	PX0718/x/15/Termination
Fixing:	Snap fit 1.2mm accommodation	Snap fit 1.5mm accommodation
Terminations:	/48 (4.8mm tab)	/ST (outlet solder tag, inlet 4.8mm tab)
Max. Rating:	10A, 250V a.c. (UL 15A, 125V a.c.)	10A, 250V a.c. (UL 15A, 250V a.c.)
Insulation Resistance:	>100MΩ (500V d.c., 1 min.)	>100MΩ (500V d.c., 1 min.)
Dielectric Strength:	2kV (50Hz, 1 min.)	2kV (50Hz, 1 min.)
Operating Temp.	-20°C to +70°C	-20°C to +70°C
Max. Pin Temp:	+70°C	+70°C
Mouldings:	Nylon 66, Flammability Rating UL94V-0	Glass filled Thermoplastic, UL94V-0
Contacts:	Brass, Tin Plated	Brass, Tin Plated
Approvals:		
Accessories / Notes:		
Mating With:	PX0587, PX0587/SE, PX0588, PX0686, PX0686/SE	PX0587, PX0587/SE, PX0588, PX0686, PX0686/SE
<b>RoHS</b>	Compliant	Compliant

## Snap Fit to Panel Outlet

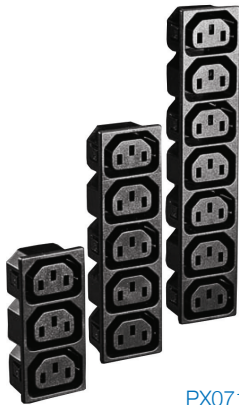

PX0717/x/xx/ST

- Snap Fit to Panel
- Panel Size 1.5mm
- Solder Tabs
- 10A, 250V a.c.  
(15A, 250V a.c. UL)
- All Terminals Linked

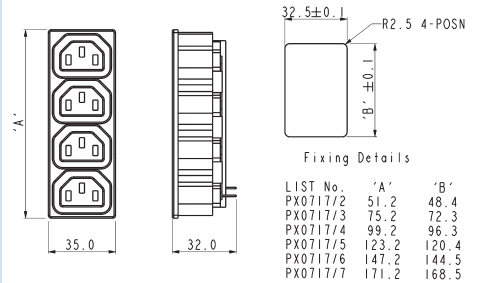



## Flange Mount Outlet

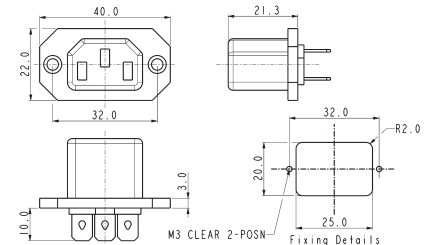

PX0578/63

- Front of Panel Mount
- 6.3mm tabs
- 10A, 250V a.c.  
(15A, 250V a.c. UL)



Specifications	PX0717/x/15/Termination	PX0578/Termination
Fixing:	Snap fit 1.5mm accommodation	Flange
Terminations:	/ST (solder)	/63 (6.3mm tab)
Max. Rating:	10A, 250V a.c. (UL 15A, 250v a.c.)	10A, 250V a.c. (UL 15A, 250v a.c.)
Insulation Resistance:	>100MΩ (500V d.c., 1 min.)	>100MΩ (500V d.c., 1 min.)
Dielectric Strength:	2kV (50Hz, 1 min.)	2kV (50Hz, 1 min.)
Operating Temp.	-20°C to +70°C	-20°C to +70°C
Max. Pin Temp:		
Mouldings:	Glass filled Thermoplastic, UL94V-0	Glass filled Thermoplastic, UL94V-0
Contacts:	Brass, Tin plated	Brass, Tin plated
Approvals:		
Accessories / Notes:		
Mating With:	PX0686, PX0686/SE	PX0686, PX0686/SE
<b>RoHS</b>	Compliant	Compliant

## Flange Mount Outlet



PX0675/28

- 2.8mm or 6.3mm Tabs
- 10A, 250V a.c.  
(15A, 250V a.c. UL & CSA).

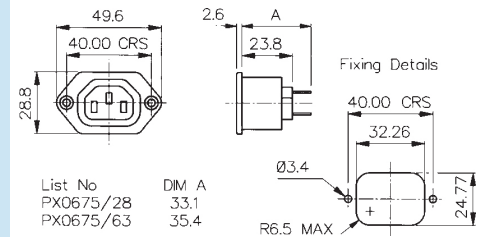



## PC Flange Rear Mount Outlet

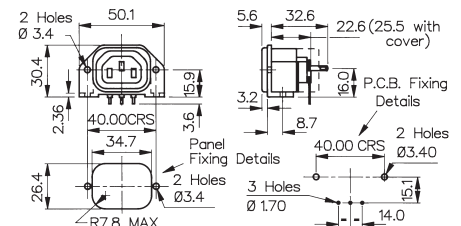

PX0675/PC

- PC Spills
- 10A, 250V a.c.  
(15A, 250V a.c. UL & CSA)



Specifications	PX0675/Term/Col	PX0675/PC/Col
Fixing:	Flange	P.C.B./Flange
Terminations:	/28 (2.8mm solder), /48 (4.8mm tab), /63 (6.3mm tab)	P.C. Spills
Colours:	No suffix (Black), /WH (White), /GY (Grey)	No suffix (Black), /WH (White), /GY (Grey)
Max. Rating:	10A, 250V a.c. (UL & CSA 15A, 250V a.c.)	10A, 250V a.c. (UL & CSA 15A, 250V a.c.)
Contact Resistance:	<10mΩ	<10mΩ
Insulation Resistance:	>10 <sup>4</sup> MΩ	>10 <sup>4</sup> MΩ
A.C. Breakdown:	Pole-Pole 7kV. Poles-Panel 9kV	Pole-Pole 4kV. Poles-Panel 9kV
Operating Temp.	-40°C to +70°C	-40°C to +70°C
Mouldings:	Nylon, Flammability Rating UL94V-0	Nylon, Flammability Rating UL94V-0
Contacts:	Brass, Tin Plated	Brass, Tin Plated
Approvals:	 UR approvals does not cover 4.8mm tab option	
Accessories / Notes:	P.No. 12075, KT0006, 14228 (See Pages 150-152) VDE and ENEC approval for black versions only.	Standard without cover. With cover add /12599 to P.No., 14228 (see page 151) VDE and ENEC approval for black versions only.
Mates with:	PX0685, PX0686, PX0686/SE	PX0685, PX0686, PX0686/SE
<b>RoHS</b>	Compliant	Compliant

## Snap Fit to Panel Outlet



PX0695/10/28

- Panel Sizes 1, 1.5, 2.0 or 3.0mm
- 2.8 or 6.3mm Tabs
- 10A, 250V a.c. (15A, 250V a.c. UL & CSA)

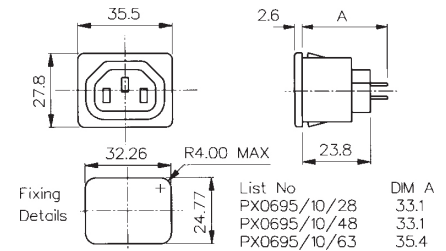

## PC Snap Fit to Panel Outlet



PX0695/10/PC

- Panel Sizes 1, 1.5, 2.0 or 3.0mm
- PC Spills
- 10A, 250V a.c. (15A, 250V a.c. UL & CSA)

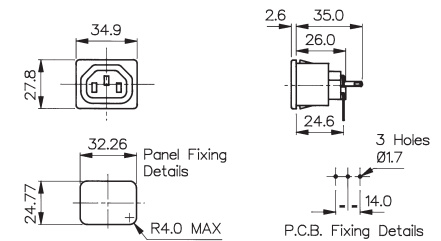

Specifications	PX0695/Panel/Term/Col	PX0695/Panel/PC/Col
Fixing:	Snap fit, /10 (1mm), /15 (1.5mm), /20 (2mm), /30 (3mm)	Snap fit, /10 (1mm), /15 (1.5mm), /20 (2mm), /30 (3mm)
Terminations:	/28 (2.8mm solder), /63 (6.3mm tab)	P.C. Spills
Colours:	No suffix (Black), /WH (White), /GY (Grey)	No suffix (Black), /WH (White), /GY (Grey)
Max. Rating:	10A, 250V a.c. (UL & CSA 15A, 250V a.c.)	10A, 250V a.c. (UL & CSA 15A, 250V a.c.)
Contact Resistance:	<10mΩ	<10mΩ
Insulation Resistance:	>10 <sup>4</sup> MΩ	>10 <sup>4</sup> MΩ
A.C. Breakdown:	Pole-Pole 7kV. Poles-Panel 9kV	Pole-Pole 4kV. Poles-Panel 9kV
Operating Temp.	-40°C to +70°C	-40°C to +70°C
Mouldings:	Nylon, Flammability Rating UL94V-0	Nylon, Flammability Rating UL94V-0
Contacts:	Brass, Tin Plated	Brass, Tin Plated
Approvals:		
Accessories / Notes:	P.No. 12075, 14228 (See Page 151-152) VDE and ENEC approval for black versions only.	P.No. 14228 (see page 151) VDE and ENEC approval for black versions only.
Mates with:	PX0685, PX0686, PX0686/SE,	PX0685, PX0686, PX0686/SE,
<b>RoHS</b>	Compliant	Compliant

## Snap Fit to Panel Outlet

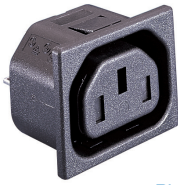

PX0783/10/28

- Shuttered
- Panel Sizes 1, 1.5, 2.0 or 3.0mm
- 2.8, 4.8 or 6.3mm Tabs
- 10A, 250V a.c.  
(15A, 250V a.c. UL & CSA)

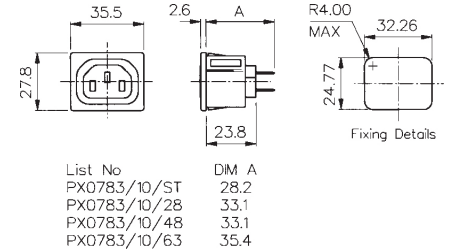

## Flange Mount Outlet



PX0793/28

- Shuttered
- 2.8, 4.8 or 6.3mm Tabs
- 10A, 250V a.c.  
(15A, 250V a.c. UL & CSA)

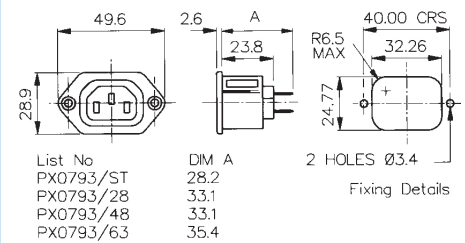





## PC Snap Fit to Panel Outlet

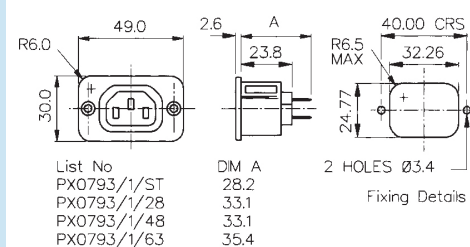

PX0793/1/Termination

- Shuttered
- Rectangular Flange Mount Outlet
- 2.8, 4.8 or 6.3mm Tabs
- 10A, 250V a.c.  
(15A, 250V a.c. UL & CSA)



Specifications	PX0783/Panel/Term/Col	PX0793/Panel/PC/Col	PX0793/1/Term/Col
Fixing:	Snap fit, /10 (1mm), /15 (1.5mm), /20 (2mm), /30 (3mm)	Flange	Rectangular Flange
Terminations:	/28 (2.8mm solder), /48 (4.8mm tab) /63 (6.3mm tab), /ST (solder)	/28 (2.8mm solder), /48 (4.8mm tab) /63 (6.3mm tab), /ST (solder)	/28 (2.8mm solder), /48 (4.8mm tab) /63 (6.3mm tab), /ST (solder)
Colours:	No suffix (Black), /WH (White), /GY (Grey)	No suffix (Black), /WH (White), /GY (Grey)	No suffix (Black), /WH (White), /GY (Grey)
Max. Rating:	10A, 250V a.c. (UL & CSA 15A, 250V a.c.)	10A, 250V a.c. (UL & CSA 15A, 250V a.c.)	10A, 250V a.c. (UL & CSA 15A, 250V a.c.)
Contact Resistance:	<10mΩ	<10mΩ	<10mΩ
Insulation Resistance:	>10 <sup>4</sup> MΩ	>10 <sup>4</sup> MΩ	>10 <sup>4</sup> MΩ
A.C. Breakdown:	Pole-Pole 7kV. Poles-Panel 9kV	Pole-Pole 7kV. Poles-Panel 9kV	Pole-Pole 7kV. Poles-Panel 9kV
Operating Temp.	-40°C to +70°C	-40°C to +70°C	-40°C to +70°C
Mouldings:	Nylon, Flammability Rating UL 94V-0	Nylon, Flammability Rating UL 94V-0	Nylon, Flammability Rating UL 94V-0
Contacts:	Brass, Tin Plated	Brass, Tin Plated	Brass, Tin Plated
Approvals:	 UR approvals does not cover 4.8mm tab option	 UR approvals does not cover 4.8mm tab option	 US approvals only covers /ST versions
Accessories / Notes:	P.No. 12075, 14228 (See Page 151-152) VDE and ENEC approval for black versions only.	P.No. 12075, KT0006, 14228 (See Pages 150-152) VDE and ENEC approval for black versions only.	P.No. 12075, KT0006, 14228 (See Pages 150-152) VDE and ENEC approval for black versions only.
Mates with:	PX0685, PX0686, PX0686/SE	PX0685, PX0686, PX0686/SE	PX0685, PX0686, PX0686/SE
RoHS	Compliant	Compliant	Compliant



## Flange Mount Outlet



PX0705/28

- Two Pin Class II (No Earth Pin)
- 2.8, 4.8 or 6.3mm Tabs
- 10A, 250V a.c.  
(15A, 250V a.c. UL & CSA)

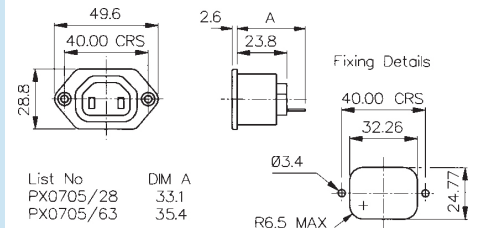

## Snap Fit to Panel Outlet



PX0725/10/28

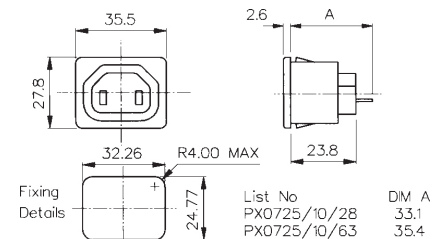

- Two Pin Class II (No Earth Pin)
- Panel Sizes 1, 1.5, 2.0 or 3.0mm
- 2.8, 4.8 or 6.3mm Tabs
- 10A, 250V a.c.  
(15A, 250V a.c. UL & CSA)



## Specifications

## PX0705/Term/Col

## PX0725/Panel/Term/Col

Fixing:	Flange	Snap fit, /10 (1mm), /15 (1.5mm), /20 (2mm), /30 (3mm)
Terminations:	/28 (2.8mm solder), /48 (4.8mm tab) /63 (6.3mm tab)	/28 (2.8mm solder), /48 (4.8mm tab) /63 (6.3mm tab)
Colours:	No suffix (Black), /WH (White), /GY (Grey)	No suffix (Black), /WH (White), /GY (Grey)
Max. Rating:	10A, 250V a.c. (UL & CSA 15A, 250V a.c.)	10A, 250V a.c. (UL & CSA 15A, 250V a.c.)
Contact Resistance:	<10mΩ	<10mΩ
Insulation Resistance:	>10 <sup>4</sup> MΩ	>10 <sup>4</sup> MΩ
A.C. Breakdown:	Pole-Pole 4kV. Poles-Panel 9kV	Pole-Pole 7kV. Poles-Panel 9kV
Operating Temp.	-40°C to +70°C	-40°C to +70°C
Mouldings:	Nylon, Flammability Rating UL94V-0	Nylon, Flammability Rating UL94V-0
Contacts:	Brass, Tin Plated	Brass, Tin Plated
Approvals:	 UR approvals does not cover 4.8mm tab option	 UR approvals does not cover 4.8mm tab option
Accessories / Notes:	P.No. 12075 (See Page 152) VDE and ENEC approval for black versions only.	P.No. 12075 (See Page 152) VDE and ENEC approval for black versions only.
RoHS	Compliant	Compliant

## C19 Straight Female Cable Connector



PX0599

- Rewirable Screw Terminals
- 16A, 250V a.c.  
(20A, 250V a.c. UL and CSA)
- Wire Sizes (max);  
3 x 2.5mm<sup>2</sup>, 3 x 12AWG
- Overall cable diameter up to 12mm

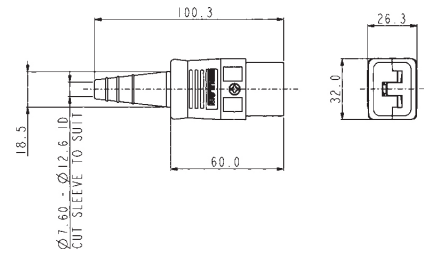

## C20 Flange Mount Inlet



PX0596

- 6.3mm or 4.8mm Tabs
- 16A, 250V a.c.  
(20A, 250V a.c. UL and CSA)

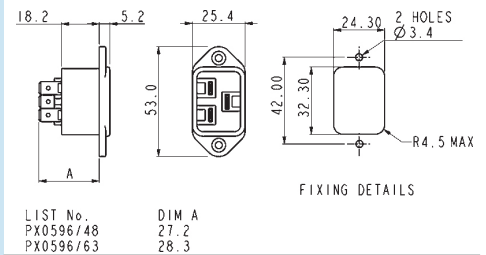





## C20 Snap Fit to Panel Inlet

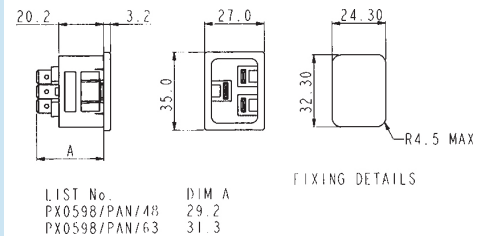

PX0598

- Fits panel sizes 1, 1.5, 2.0 or 3.0mm
- 6.3mm or 4.8mm Tabs
- 16A, 250V a.c.  
(20A, 250V a.c. UL and CSA)



Specifications	PX0599	PX0596/Termination	PX0598/Panel/Termination
Fixing (Panel):		Flange	Snap Fit, /10 (1mm), /15 (1.5mm), /20 (2mm), /30 (3mm)
Terminations:	Screw Terminals	/63 (6.3mm tab), /48 (4.8mm tab)	/63 (6.3mm tab), /48 (4.8mm tab)
Max. Rating:	16A, 250V ac 20A, 250V ac UL and CSA	16A, 250V ac 20A, 250V ac UL and CSA	16A, 250V ac 20A, 250V ac UL and CSA
Insulation Resistance:	>5M $\Omega$	>10 <sup>6</sup> M $\Omega$	>10 <sup>6</sup> M $\Omega$
Dielectric Strength Between contacts:	1.5kV ac	1.5kV ac	1.5kV ac
Between contacts & accessible surfaces:	3kV ac	3kV ac	3kV ac
Operating Temp. Range:	-40°C to +70°C	-40°C to +70°C	-40°C to +70°C
Max. Pin Temp.:		70°C	70°C
Withdrawal Force:	15N Min, 60N Max.		
Mouldings:	Nylon, Flammability Rating UL94V-0	Nylon, Flammability Rating UL94V-0	Nylon, Flammability Rating UL 94V-0
Contacts:	Brass, Clean	Pins: Brass, Nickel Plated Tabs: Brass, Tin Plate	Pins: Brass, Nickel Plated Tabs: Brass, Tin Plated
Approvals:			
Mating Connectors:	C20 Inlets; PX0596 Flange and PX0598 Snapfit	PX0599 Rewirable Connector	PX0599 Rewirable Connector
Accessories:		KT0012, P.No. 14064 (see Pages 150 & 152)	P.No. 14064 (see Page 152)
RoHS	Compliant	Compliant	Compliant

## Flange Mount Outlet



PX0591/63

- Flange Mounting
- 6.3mm Tabs
- 16A, 250V a.c.  
(20A, 250V a.c., UL & CSA)

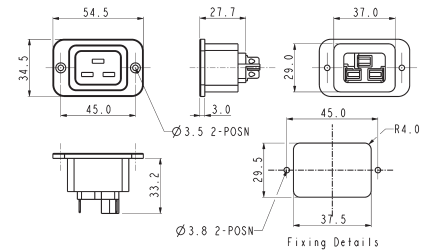



## Snap Fit to Panel Outlet

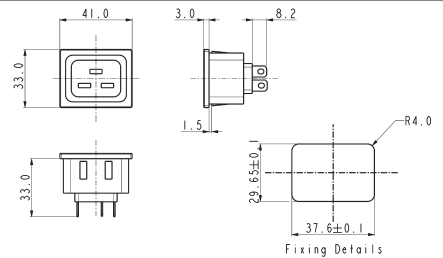

PX0592/15/63

- Snap Fit to Panel
- Panel Size 1.5mm
- 6.3mm Tabs
- 16A, 250V a.c.  
(20A, 250V a.c., UL & CSA)



Specifications	PX0591/Termination	PX0592/15/Termination
Fixing (Panel):	Flange	Snap fit, 1.5mm accommodation
Terminations:	/63 (6.3mm tab)	/63 (6.3mm tab)
Max. Rating:	16A, 250V a.c. (UL & CSA 20A, 250V a.c.)	16A, 250V a.c. (UL & CSA 20A, 250V a.c.)
Insulation Resistance:	>100MΩ (250V, 1 min.)	>100MΩ (250V, 1 min.)
Dielectric Strength		
Between contacts:	1.5kV ac	1.5kV ac
Between contacts & accessible surfaces:	3kV ac	3kV ac
Operating Temp. Range:	-40°C to +70°C	-40°C to +70°C
Max. Pin Temp.:		
Withdrawal Force:		
Mouldings:	P.B.T., Flammability Rating UL94V-0	Nylon, Flammability Rating UL94V-0
Contacts:	Brass, Tin Plated	Brass, Tin Plated
Approvals:		
Accessories:		
<b>RoHS</b>	Compliant	Compliant

Retaining Clip



KT0006  
(Shown with PX0580 & PX0587)

- Prevents Accidental Removal
- Fits flanged inlets

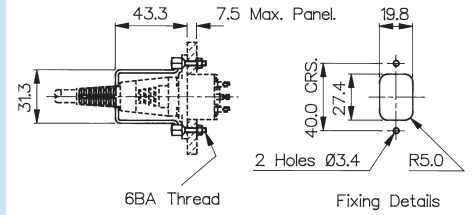

Retaining Clip

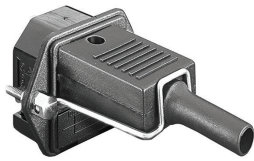

KT0009  
(Shown with PF0001 & PX0587)

- Prevents Accidental Removal
- Fits fused flanged inlets

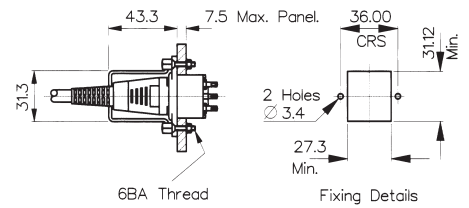

Retaining Clip



KT0012  
(Shown with PX0596 & PX0599)

- Prevents Accidental Removal
- For use with PX0596 flanged inlet and PX0599 connector

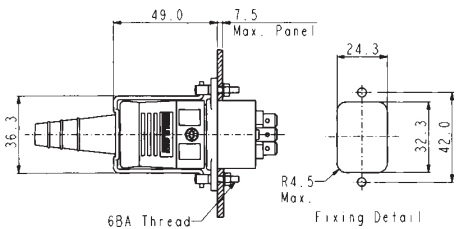

Specifications

KT0006

Retaining Clip to prevent accidental removal of connector.

Fits: PX0580 + PX0587 PX0590 + PX0597  
PX0690 + PX0587  
PX0675 + PX0686  
PX0793 + PX0686  
PX0793/1 + PX0686

KT0009

Retaining Clip to prevent accidental removal of connector.

Fits: PF0001+ PX0587  
PF0001/PC +PX0587  
PF0002 + PX0587  
PF0030 + PX0587

KT0012

Retaining Clip to prevent accidental removal of connector.

Fits: PX0596 + PX0599

Material:

Clip: Stainless Steel, other parts Brass, Nickel Plated

Clip: Stainless Steel, other parts Brass, Nickel Plated

Clip: Stainless Steel, other parts Brass, Nickel Plated

RoHS

Compliant

Compliant

Compliant

Blanking Cover

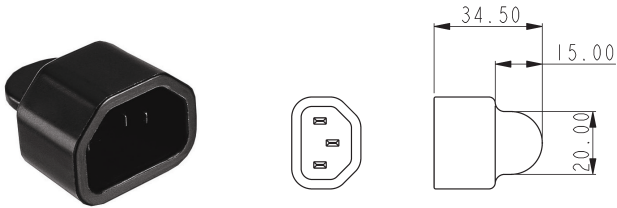

PNo 14228

Insulation Boot

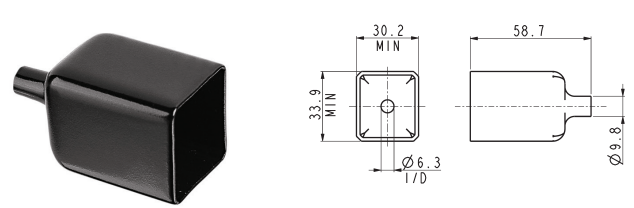

PNo 14340

Blanking Cover

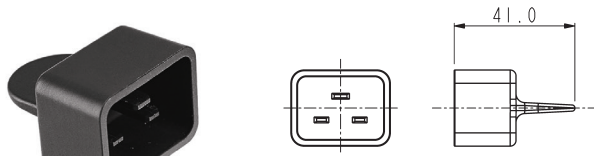

PNo 14277

Insulation Boot

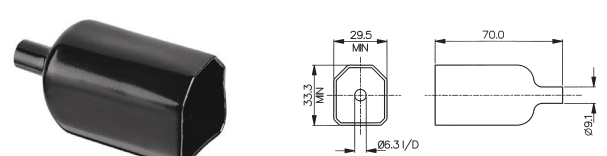

PNo 14317

- Blanking covers
- Protects Front of Outlet Connector
- Protects Against Accidental Electric Shock

- PVC Insulation Boots
- Protects Rear of Connector
- Protects Against Accidental Electric Shock

Specifications	P.No. 14228	P.No. 14277	P.No. 14340	P.No. 14317
	Blanking cover for PX0578, PX0675, PX0695, PX0783, PX0793, PX0716, PX0717, PX0718	Blanking cover for PX0591, PX0592,	Insulation boot for PS20, PS21, PS25, PS25,	Insulation boot for PF0030, PF0033 (except /PC versions)
Operating Temp:	-40°C to +70°C	-40°C to +70°C	-20°C to +60°C	-20°C to +60°C
Max. Working Voltage:	250V a.c.	250V a.c.	250V a.c.	250V a.c.
Flash Tested:	2kV a.c.	2kV a.c.	2kV a.c.	2kV a.c.
Material:	Nylon	Nylon	P.V.C.	P.V.C.
Flammability Rating:	UL94V-0	UL94V-0	UL94V-0	UL94V-0
<b>RoHS</b>	Compliant	Compliant	Compliant	Compliant

Insulation Boot

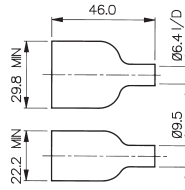

PNo 11328

Insulation Boot

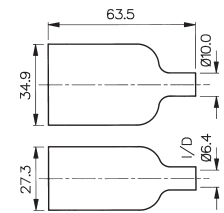

PNo 12075

Insulation Boot

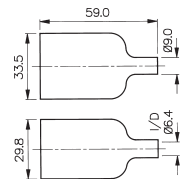

PNo 11987

Insulation Boot

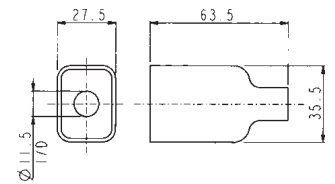





PNo 14064

- PVC Insulation Boots
- Protects Rear of Connector
- Protects Against Accidental Electric Shock

Specifications	P.No. 11328	P.No. 11987	P.No. 12075	P.No. 14064
	Insulation boot for PX0575, PX0579, PX0580, PX0590, PX0595	Insulation boot for PF range PF0001, PF0002, PF0006, PF0007, PF0011, PF0016 (Except /PC versions)	Insulation boot for PX0675, PX0695, PX0705, PX0725, PX0783, PX0793, PX0793/1 (Except /PC versions)	Insulation boot for PX0596, PX0598
Operating Temp:	-20°C to +60°C	-20°C to +60°C	-20°C to +60°C	-20°C to +60°C
Max. Working Voltage:	250V a.c.	250V a.c.	250V a.c.	250V a.c.
Flash Tested:	2kV a.c.	2kV a.c.	2kV a.c.	2kV a.c.
Material:	P.V.C.	P.V.C.	P.V.C.	P.V.C.
Flammability Rating:	UL94V-0	UL94V-0	UL94V-0	UL94V-0
<b>RoHS</b>	Compliant	Compliant	Compliant	Compliant

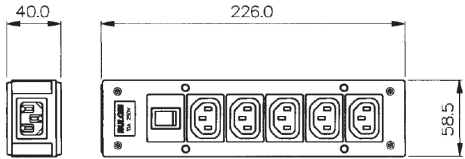
Distribution Units have combinations of **four, five or six outlets** together with **neon indicator**, fuse and switch options. The **three sizes** are available in various combinations and, other than the compact version, all have shuttered outlets. The larger enclosed versions are also available with **EMI filtering**.

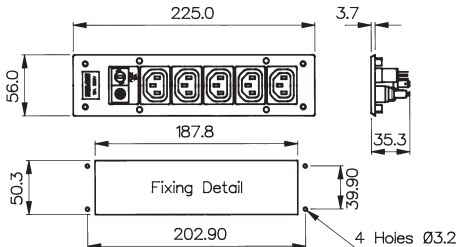

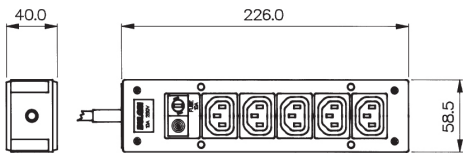
<p>IEC Distribution Units</p>  <p>PXD301/050/01/1</p>	<ul style="list-style-type: none"> <li>○ Five Shuttered Outlets</li> <li>○ 5 x 20mm Fuseholder</li> <li>○ Neon Indicator</li> <li>○ Filtered or Non-filtered</li> <li>○ EN60320 Inlet</li> <li>○ 10A, 250V a.c.</li> </ul>	
<p>IEC Panel Mount Distribution Unit</p>  <p>PXD100/050/01/1</p>	<ul style="list-style-type: none"> <li>○ Five Shuttered Outlets</li> <li>○ 5 x 20mm Fuseholder</li> <li>○ Neon Indicator</li> <li>○ Screw Fit to Panel</li> <li>○ 10A, 250V a.c.</li> </ul>	
<p>IEC Distribution Unit</p>  <p>PXD303/050/01/1              PXD306/050/01/1</p>	<ul style="list-style-type: none"> <li>○ Five Shuttered Outlets</li> <li>○ 5 x 20mm Fuseholder</li> <li>○ Neon Indicator</li> <li>○ Filtered or Non-filtered</li> <li>○ 2 Metre Cable with BS1363 Plug</li> <li>○ 10A, 250V a.c.</li> </ul>	

Part No.	Inlet	Outlet	EMI Filter	Neon Indicator	Fuse	Illuminated Switch	Approvals
Panel Style:							
PXD100/050/01/1		5 Shuttered		1	1		Ⓢ
Box Style:							
PXD301/050/01/1	1	5 Shuttered		1	1		Ⓢ
PXD301/050/07/1	1	5 Shuttered				Red	
PXD301/050/08/1	1	5 Shuttered				Green	
PXD301/550/01/1	1	5 Shuttered	●	1	1		
PXD301/550/07/1	1	5 Shuttered	●			Red	Ⓢ
PXD301/550/08/1	1	5 Shuttered	●			Green	
PXD303/050/01/1	2m cable with BS1363 plug	5 Shuttered		1	1		
PXD303/050/07/1	2m cable with BS1363 plug	5 Shuttered				Red	
PXD303/050/08/1	2m cable with BS1363 plug	5 Shuttered				Green	
PXD303/550/01/1	2m cable with BS1363 plug	5 Shuttered	●	1	1		
PXD303/550/07/1	2m cable with BS1363 plug	5 Shuttered	●			Red	
PXD303/550/08/1	2m cable with BS1363 plug	5 Shuttered	●			Green	
PXD306/050/01/1	2m cable with CEE7 Sheet VII plug	5 Shuttered		1	1		Ⓢ



IEC Distribution Unit



PXD301/050/07/1

- Five Shuttered Outlets
- Illuminated Switch
- Filtered or Non-Filtered
- EN60320 Inlet
- 10A, 250V a.c.

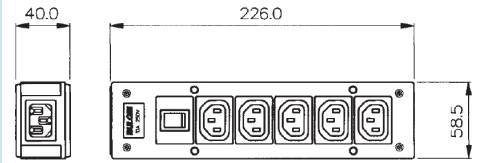

IEC Distribution Unit



PXD303/050/08/1

- Five Shuttered Outlets
- Illuminated Switch
- Filtered or Non-Filtered
- 2m Cable and BS1363 plug
- 10A, 250V a.c.

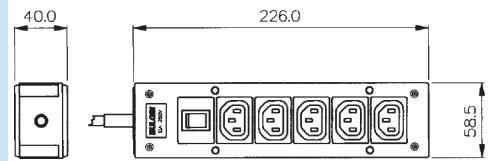

**Specifications**

Mouldings:	Thermoplastic
Housing:	ABS
Connectors:	Nylon
Contacts:	Outlets: Brass, Tin Plated Inlets: Brass, Nickel Plated
Voltage Rating:	250V a.c. 50/60Hz
Current Rating:	10A
Proof Voltage:	2kV
Temp. Range:	-5°C to +60°C
Mating Connectors:	PX0686, PX0686/SE
<b>RoHS</b>	Compliant

**Filter**

Max. Earth Leakage Current:	<0.35mA (at 250V, 50Hz)
Capacitor	2 x 2.2nF (Y), 1 x 15nF (X)
Inductance:	2 x 0.35mH
Fuse:	5 x 20mm, 10A (ceramic HRC type, IEC 127)

Compact Distribution Unit



PXD200

- Four Outlets
- EN60320 Inlet
- 10A, 250V ac
- cULus Approval

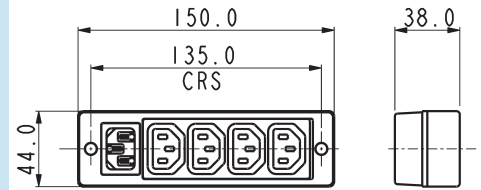

Compact Distribution Unit



PXD201



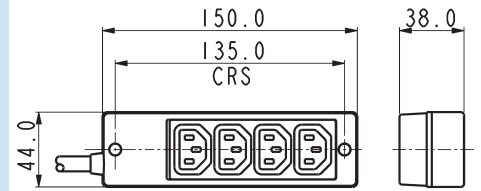

- Four Outlets
- 2m Cable with BS1363 connector, Schuko connector (CEE7) or NEMA 5/15 connector
- 10A, 250V a.c.

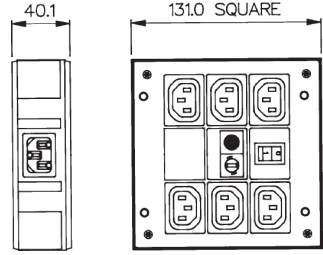

**Specifications**

Mouldings:	Thermoplastic
Housing:	ABS, UL94V-0
Connectors:	BS1363, CEE7, NEMA 5/15
Contacts:	Outlets: Brass, Tin Plated Inlets: Brass, Nickel Plated
Voltage Rating:	250V a.c. 50/60Hz
Current Rating:	10A
Proof Voltage:	2kV
Temp. Range:	-5°C to +60°C
Approvals	cULus Listed (PXD200)
<b>RoHS</b>	Compliant

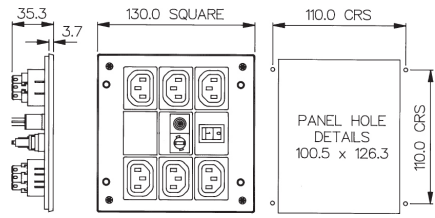
Part No.	Inlet	Outlet
PXD200	1	4
PXD201	2m cable with BS 1363 plug	4
PXD201/1	2m cable with Schuko plug	4
PXD201/2	2m cable with NEMA 5/15	4

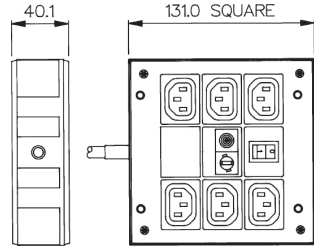
<p>Compact Distribution Unit</p>  <p>PXD701/061/10/1</p>	<ul style="list-style-type: none"> <li>○ Six Shuttered Outlets</li> <li>○ 5 x 20mm Fuseholder</li> <li>○ Filtered or Non Filtered</li> <li>○ Switch, Fuse, Neon Indicator</li> <li>○ With IEC Inlet</li> <li>○ 10A, 250V a.c.</li> </ul>	
<p>IEC Mount Distribution Unit</p>  <p>PXD500/061/10/1</p>	<ul style="list-style-type: none"> <li>○ Six Shuttered Outlets</li> <li>○ 5 x 20mm Fuseholder</li> <li>○ Filtered or Non Filtered</li> <li>○ Switch, Fuse, Neon Indicator</li> <li>○ Screw Fit to Panel</li> <li>○ 10A, 250V</li> </ul>	
<p>Compact Distribution Unit</p>  <p>PXD703/061/10/1                  PXD706/061/10/1</p>	<ul style="list-style-type: none"> <li>○ Six Shuttered Outlets</li> <li>○ 5 x 20mm Fuseholder</li> <li>○ Filtered or Non Filtered</li> <li>○ Switch, Fuse, Neon Indicator</li> <li>○ 2 Metre Cable with BS1363 or CEE7 Plug</li> <li>○ 10A, 250V</li> </ul>	

Specifications		Part No.	Inlet	Outlet	EMI Filter	Switch	Fuse	Neon Indicator
Mouldings:	Thermoplastic	Panel Style: PXD500/061/10/1		6 Shuttered		1	1	1
Housing:	ABS	Box Style: PXD701/061/10/1	1	6 Shuttered		1	1	1
Connectors:	Nylon	PXD701/561/10/1	1	6 Shuttered	●	1	1	1
Contacts:	Outlets: Brass, Tin Plated Inlets: Brass, Nickel Plated	PXD703/061/10/1	2m cable with BS 1363 plug	6 Shuttered		1	1	1
Voltage Rating:	250V a.c. 50/60Hz	PXD703/561/10/1	2m cable with BS 1363 plug	6 Shuttered	●	1	1	1
Current Rating:	10A	PXD706/061/10/1	2m cable with CEE7 Sheet VII plug	6 Shuttered		1	1	1
Proof Voltage:	2kV							
Temp. Range:	-5°C to +60°C							
<b>RoHS</b>	Compliant							

**Filter**

Max. Earth Leakage Current:	<0.35mA (at 250V, 50Hz)
Capacitor	2 x 2.2nF (Y), 1 x 15nF (X)
Inductance:	2 x 0.35mH
Fuse:	5 x 20mm, 10A (ceramic HRC type, IEC 127)



With over 26,000 combinations Bulgin's mains power entry modules offer a very adaptable and flexible solution to panel design. Power entry modules allow combinations of mains inlets and outlets, filtered inlets, switches, fuseholders, voltage selectors and indicators mounted in either horizontal or vertical format bezels ready for quick snap-fit assembly. The compact design occupies the minimum of panel area and a single rectangular mounting hole, offering easy installation for this mains power entry module.

Our range offers a flange fixing alternative for designers who prefer the security of screw fixing. All types and variations are available through Bulgin's extensive distribution network.

### Components used in Power Entry Modules.

**Note: Components are Approved Individually (where applicable). Please see individual component pages for full specifications.**

### IEC Connectors Fuseholders and Voltage Selectors

Type	Description	Rating	Approvals
DX0928	Neon Indicator	110V or 250V a.c./d.c. working	
FX0359	5 x 20mm Fuseholder	Max. rating 10A. 250V See Page 192	
PF0011	C14 Power Inlet with Integral 5 x 20mm Fuseholder	Max. rating 10A. 250V a.c. See Page 136	
PF0033	C14 Power Inlet with Integral twin 5 x 20mm Fuseholder	Max. rating 10A. 250V a.c. See Page 137	
PX0575	C14 Power Inlet, Cold condition	Max. rating 10A. 250V a.c. See Page 132	
PX0595	C16 Power Inlet, Hot Condition	Max. rating 10A. 250V a.c. See Page 138	
PX0695	Sheet F Power Outlet	Max. rating 10A. 250V a.c. See Page 145	
PX0783	Sheet F Shuttered Power Outlet	Max. rating 10A. 250V a.c. See Page 146	
PX0598	C20 Power Inlet	Max. rating 16A, 250V a.c. See Page 148	
VS0001	Voltage Selector marked 120/240V	Max. rating 6.3A. 120/240V a.c. See Page 114	

\*Filtered options for 6.3mm tag versions only

### Switches and Indicators

No Poles	Illumination	Current Ratings	Circuit	Approvals
Single Pole	Non-illuminated	Max. rating 16A Resistive, 4A Inductive, 250Vac.		
	High Inrush	Max. rating 16A Resistive, 4A Inductive, 250Vac. Inrush current, 150A to IEC65.		
	Illuminated	Max. rating 16A Resistive, 4A Inductive, 250Vac.		
Double Pole	Non-illuminated	Max. rating 16A Resistive, 4A Inductive, 250Vac.		
	High Inrush	Max. rating 16A Resistive, 4A Inductive, 250Vac. Inrush current, 150A to IEC65.		
	Illuminated	Max. rating 16A Resistive, 4A Inductive, 250Vac. 250Vac Neon.		
For Mini Bezel: Single Pole	Non-illuminated	Max. rating 10A Resistive, 4A Inductive, 250Vac.		
	Illuminated	Max. rating 10A Resistive, 4A Inductive, 250Vac. 250Vac Neon.		
Double Pole	Non-illuminated	Max. rating 10A Resistive, 4A Inductive, 250Vac.		
	High Inrush	Max. rating 10A Resistive, 4A Inductive, 250Vac. Inrush current, 85A to EN61058-1.		
	Illuminated	Max. rating 10A Resistive, 4A Inductive, 250Vac. 250Vac Neon.		
Indicator		250Vac neon lamp connected internally to terminals.		

**RoHS** Power Entry Module range and all components are compliant

## Overview of Power Entry Modules

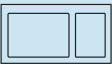
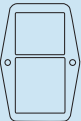
Style	Inlets				Outlets	Inlet/ Outlet Combinations	
	C14	C14 Fused	C16	C20	Sheet F	C14	C14 Fused
Snap to Panel Vertical  	With Single Pole switch Page 163  With other components Pages 164, 165, 166	With Single Pole switch Page 161  With Double Pole Switch Page 162	With Single Pole switch Page 163  With other components Pages 164, 165, 166	With Single Pole switch Page 167	With Single Pole switch Page 169	With other components Page 168	
Snap to Panel Horizontal  	Mini Bezel With Single Pole Switch Page 175  Mini Bezel With Double Pole Switch Page 175	With Single Pole switch Page 170  With Double Pole Switch Page 171				With Single Pole switch Page 177	With Double Pole switch Page 173  No additional components Page 174
Flange Mount - Vertical  		With Single Pole switch Page 176  With Double Pole switch Page 177					

Vertical Module Arrangement



BZV01/Z0000/01

- Fused Inlet with 2.8mm or 6.3mm tabs
- Single Pole Switch Variations
- Filtered Inlet Option
- Options of I/O marked switches

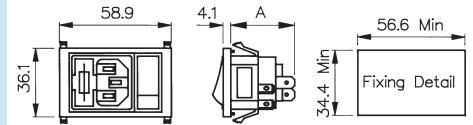

BZV01/\*\*\*\*\*/\*\* } A = 59.7 With Filter  
 BZV02/\*\*\*\*\*/\*\* } A = 27.4 Without Filter  
 BZV15/\*\*\*\*\*/\*\* } A = 59.7 With Filter  
 BZV16/\*\*\*\*\*/\*\* } A = 37.9 Without Filter  
 Panel Thickness. 1.0, 1.5, 2.0, 3.0mm.

How to order -



**Type of Inlet / Outlet**

Single Fused C14 Power Inlet (cold condition),  
6.3 or 2.8mm tabs:  
01 = PF0011/63  
02 = PF0011/28

Twin Fused C14 Power Inlet (cold condition),  
6.3 or 2.8mm tabs:  
15 = PF0033/63  
16 = PF0033/28

**Filtered or Non Filtered Inlet**

Z0000 = Non Filtered  
Axxxx = Standard

For Filtered inlet use 6th to 9th characters from filter ordering code see pages 179 -180  
E.g. BZV01/A0620/01

**Filtered or Non Filtered Inlet**

Single Pole Switch:  
01 = S.P. Switch

Single Pole Neon Switch:  
02 = S.P. Red Neon Switch  
08 = S.P. Green Neon Switch

Neon Indicator:  
03 = Red Neon Indicator

Single Pole High Inrush Switch:  
46 = S.P. High Inrush Switch

Single Pole Switch Marked I/O:  
69 = S.P. Switch (I/O)

Single Pole Neon Switch Marked (I/O):  
71 = S.P. Red Neon Switch (I/O)  
74 = S.P. Green Neon Switch (I/O)

Single Pole High Inrush Switch Marked (I/O):  
98 = S.P. High Inrush Switch (I/O)

## Vertical Module Arrangement



BZV01/Z0000/10

- Fused Inlet with 2.8mm or 6.3mm tabs
- Double Pole Switch or Indicator Variations
- Filtered Inlet Option
- Options of I/O marked switches

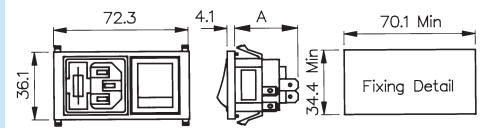

BZV01/\*\*\*\*\*/\*\* } A = 59.7 With Filter  
 BZV02/\*\*\*\*\*/\*\* } A = 27.4 Without Filter  
 BZV15/\*\*\*\*\*/\*\* } A = 59.7 With Filter  
 BZV16/\*\*\*\*\*/\*\* } A = 37.9 Without Filter  
 Panel Thickness: 1.0, 1.5, 2.0, 3.0mm.

## How to order -

**BZV XX****XXXXX****XX****Type of Inlet / Outlet**

Single Fused C14 Power Inlet (cold condition),  
 6.3 or 2.8mm tabs:  
 01 = PF0011/63  
 02 = PF0011/28

Twin Fused C14 Power Inlet (cold condition),  
 6.3 or 2.8mm tabs:  
 15 = PF0033/63  
 16 = PF0033/28

**Filtered or Non Filtered Inlet**

Z0000 = Non Filtered

Axxxx = Standard

For Filtered inlet use 6th to 9th characters from filter  
 ordering code see pages 179-180  
 E.g. BZV01/A0620/10

**Combination of Other Components**

Neon Indicator:  
 D3 = Red Neon Indicator

Double Pole Switch:  
 10 = D.P. Switch

Double Pole Neon Switch:  
 11 = D.P. Red Neon Switch  
 12 = D.P. Green Neon Switch

Double Pole High Inrush Switch:  
 13 = D.P. High Inrush Switch

Double Pole Switch Marked I/O:  
 70 = D.P. Switch (I/O)

Double Pole Neon Switch Marked (I/O):  
 76 = D.P. Red Neon Switch (I/O)  
 77 = D.P. Green Neon Switch (I/O)

Double Pole High Inrush Switch Marked  
 (I/O):

78 = D.P. High Inrush Switch (I/O)  
 B1 = D.P. High Inrush Green Neon Switch  
 (I/O)



## Vertical Module Arrangement



BZV03/Z0000/02

- Inlet with 2.8mm or 6.3mm tags
- Single Pole Switch or Neon Indicator Variations
- Filtered Inlet Option
- Options of I/O marked switches
- Non Fused

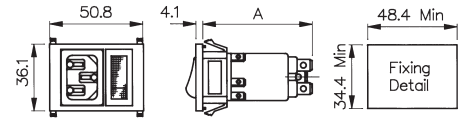

BZV03, BZV04/\*\*\*\*/\*\* A = 62.5 With Filter  
 28.1 Without Filter  
 BZV05, BZV06/\*\*\*\*/\*\* A = 28.1

Panel Thickness. 1.0, 1.5, 2.0, 3.0mm.

## How to order -

**BZV XX****XXXXX****XX****Type of Inlet / Outlet**

C14 Power Inlet (cold condition), 6.3 or 2.8mm tabs:

03 = PX0575/63  
 04 = PX0575/28

C16 Power Inlet (hot condition), 6.3 or 2.8mm tabs:

05 = PX0595/63  
 06 = PX0595/28

Please note type 05 and 06 are not available in filtered version

**Filtered or Non Filtered Inlet**

Z0000 = Non Filtered

Axxxx = Standard

For Filtered inlet use 6th to 9th characters from filter ordering code see page 178  
 E.g. BZV03/A0120/02

**Combination of Other Components**

Single Pole Switch:  
 01 = S.P. Switch

Single Pole Neon Switch:  
 02 = S.P. Red Neon Switch  
 08 = S.P. Green Neon Switch

Neon Indicator:  
 03 = Red Neon Indicator  
 Single Pole High Inrush Switch:  
 46 = S.P. High Inrush Switch

Single Pole Switch Marked I/O:  
 69 = S.P. Switch (I/O)

Single Pole Neon Switch Marked (I/O):  
 71 = S.P. Red Neon Switch (I/O)  
 74 = S.P. Green Neon Switch (I/O)

Single Pole High Inrush Switch Marked (I/O):

98 = S.P. High Inrush Switch (I/O)

## Vertical Module Arrangement



BZV03/Z0000/07

- Inlet with 2.8mm or 6.3mm tabs
- Double Pole Switch/  
Fuseholder/Indicator/  
Voltage Selectors/  
Blanking Plate
- Filtered Inlet Option
- Options of I/O marked switches

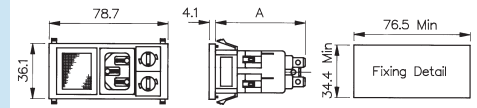

Panel Thickness: 1.0, 1.5, 2.0, 3.0mm.

BZV03, BZV04/\*\*\*\*/\*\* A = 62.5 With Filter  
39.0 Without Filter

BZV05, BZV06/\*\*\*\*/\*\* A = 39.0

## How to order -

**BZV XX****XXXXX****XX**

Type of Inlet / Outlet	Filtered or Non Filtered Inlet	Combination of Other Components	
C14 Power Inlet (cold condition), 6.3 or 2.8mm tabs:	Z0000 = Non Filtered Axxxx = Standard	Twin Fuseholder and Double Pole Switch: 05 = 2 x FX0359 + D.P. Switch	Voltage Selector, Neon Indicator and Double Pole Switch 25 = 1 x VS0001 + 1 x DX0928/110V/Red + D.P. Switch 26 = 1 x VS0001 + 1 x DX0928/110V/Green + D.P. Switch 27 = 1 x VS0001 + 1 x DX0928/250V/Red + D.P. Switch 28 = 1 x VS0001 + 1 x DX0928/250V/Green + D.P. Switch
03 = PX0575/63 04 = PX0575/28	For Filtered inlet use 6th to 9th characters from filter ordering code see page 178 E.g. BZV03/A0120/07	Twin Fuseholder and Double Pole Neon Switch: 06 = 2 x FX0359 + D.P. Red Neon Switch 09 = 2 x FX0359 + D.P. Green Neon Switch 19 = 2 x FX0359 + D.P. Red Neon Switch 125V	Voltage Selector, Neon Indicator and Double Pole High Inrush Switch: 29 = 1 x VS0001 + 1 x DX0928/250V/Red + D.P. High Inrush Switch 30 = 1 x VS0001 + 1 x DX0928/250V/Green + D.P. High Inrush Switch
C16 Power Inlet (hot condition), 6.3 or 2.8mm tabs:		Twin Fuseholder and Neon Indicator: 07 = 2 x FX0359 + Red Neon Indicator	Fuseholder, Neon Indicator and Double Pole Switch 31 = 1 x FX0359 + 1 x DX0928/110V/Red + D.P. Switch 32 = 1 x FX0359 + 1 x DX0928/110V/Green + D.P. Switch 33 = 1 x FX0359 + 1 x DX0928/250V/Red + D.P. Switch 34 = 1 x Fx0359 + 1 x DX0928/250V/Green + D.P. Switch
05 = PX0595/63 06 = PX0595/28		Voltage Selector, Fuseholder and Double Pole Switch: 15 = 1 x VS0001 + 1 x FX0359 + Double Pole switch	Fuseholder, Neon Indicator and Double Pole High Inrush Switch: 35 = 1 x FX0359 + 1 x DX0928/250V/Red + D.P. High Inrush Switch 36 = 1 x FX0359 + 1 x DX0928/250V/Green + D.P. High Inrush Switch
Please note type 05 and 06 are not available in filtered version		Voltage Selector, Fuseholder and Double Pole Neon Switch: 16 = 1 x VS0001 + 1 x FX0359 + D.P. Red Neon Switch 18 = 1 x VS0001 + 1 x FX0359 + D.P. Green Neon Switch	Fuseholder, Blanking Plate and Double Pole High Inrush Neon Switch: 47 = 1 x FX0359 + 1 x Blanking Plate (Right) + D.P. High Inrush Green Neon Switch
		Voltage Selector, Fuseholder and Neon Indicator: 17 = 1 x VS0001 + 1 x FX0359 + Red Neon Indicator	Fuseholder, Blanking Plate and Double Pole Switch: 48 = 1 x FX0359 + 1 x Blanking Plate (Right) + D.P. Switch
		Twin Fuseholder and Double Pole High Inrush Switch: 20 = 2 x FX0359 + D.P. High Inrush Switch	
		Twin Fuseholder and Double Pole High Inrush Neon Switch: 21 = 2 x FX0359 + 1 x D.P. High Inrush Green Neon Switch 22 = 2 x FX0359 + 1 x D.P. High Inrush Red Neon Switch	

Vertical Module Arrangement



BZV03/Z0000/07

- Inlet with 2.8mm or 6.3mm tags
- Double Pole Switch/
- Fuseholder/Indicator/ Voltage Selectors/ Blanking Plate
- Filtered Inlet Option
- Options of I/O marked switches

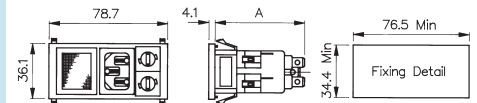

Panel Thickness: 1.0, 1.5, 2.0, 3.0mm.  
 BZV03, BZV04/\*\*\*\*\*/\*\* A = 62.5 With Filter  
 39.0 Without Filter  
 BZV05, BZV06/\*\*\*\*\*/\*\* A = 39.0

How to order -

**BZV XX / XXXXX / XX**

**Type of Inlet / Outlet**

C14 Power Inlet (cold condition), 6.3 or 2.8mm tabs:

03 = PX0575/63  
 04 = PX0575/28

C16 Power Inlet (hot condition), 6.3 or 2.8mm tabs:

05 = PX0595/63  
 06 = PX0595/28

Please note type 05 and 06 are not available in filtered version

**Filtered or Non Filtered Inlet**

Z0000 = Non Filtered

Axxxx = Standard

For Filtered inlet use 6th to 9th characters from filter ordering code see page 178  
 E.g. BZV03/A0120/07

**Combination of Other Components**

Twin Fuseholder and Double Pole Switch Marked (I/O):  
 72 = 2 x FX0359 + D.P. Switch (I/O)

Twin Fuseholder and Double Pole Neon Switch Marked (I/O):  
 73 = 2 x FX0359 + D.P. Red Neon Switch (I/O)  
 75 = 2 x FX0359 + D.P. Green Neon Switch (I/O)  
 82 = 2 x FX0359 + D.P. Red Neon Switch 125V(I/O)

Voltage Selector, Fuseholder and Double Pole Switch Marked (I/O):  
 79 = 1 x VS0001 + 1 x FX0359 + Double Pole switch (I/O)

Voltage Selector, Fuseholder and Double Pole Neon Switch Marked (I/O):  
 80 = 1 x VS0001 + 1 x FX0359 + D.P. Red Neon Switch (I/O)  
 81 = 1 x VS0001 + 1 x FX0359 + D.P. Green Neon Switch (I/O)

Twin Fuseholder and Double Pole High Inrush Switch Marked (I/O):  
 83 = 2 x FX0359 + D.P. High Inrush Switch (I/O)

Twin Fuseholder and Double Pole High Inrush Neon Switch Marked (I/O):  
 84 = 2 x FX0359 + 1 x D.P. High Inrush Green Neon Switch (I/O)  
 85 = 2 x FX0359 + 1 x D.P. High Inrush Red Neon Switch (I/O)

Voltage Selector, Neon Indicator and Double Pole Switch Marked (I/O):  
 86 = 1 x VS0001 + 1 x DX0928/110V/Red + D.P. Switch (I/O)  
 87 = 1 x VS0001 + 1 x DX0928/110V/Green + D.P. Switch (I/O)  
 88 = 1 x VS0001 + 1 x DX0928/250V/Red + D.P. Switch (I/O)  
 89 = 1 x VS0001 + 1 x DX0928/250V/Green + D.P. Switch (I/O)

Voltage Selector, Neon Indicator and Double Pole High Inrush Switch Marked (I/O):  
 90 = 1 x VS0001 + 1 x DX0928/250V/Red + D.P. High Inrush Switch (I/O)  
 91 = 1 x VS0001 + 1 x DX0928/250V/Green + D.P. High Inrush Switch (I/O)

Fuseholder, Neon Indicator and Double Pole Switch Marked (I/O):  
 92 = 1 x FX0359 + 1 x DX0928/110V/Red + D.P. Switch (I/O)  
 93 = 1 x FX0359 + 1 x DX0928/110V/Green + D.P. Switch (I/O)  
 94 = 1 x FX0359 + 1 x DX0928/250V/Red + D.P. Switch (I/O)  
 95 = 1 x FX0359 + 1 x DX0928/250V/Green + D.P. Switch (I/O)

Fuseholder, Neon Indicator and Double Pole High Inrush Switch Marked (I/O):  
 96 = 1 x FX0359 + 1 x DX0928/250V/Red + D.P. High Inrush Switch (I/O)  
 97 = 1 x FX0359 + 1 x DX0928/250V/Green + D.P. High Inrush Switch (I/O)

Fuseholder, Blanking Plate and Double Pole High Inrush Neon Switch Marked (I/O):  
 99 = 1 x FX0359 + 1 x Blanking Plate (Right) + D.P. High Inrush Green Neon Switch (I/O)

Fuseholder, Blanking Plate and Double Pole Switch Marked (I/O):  
 A0 = 1 x FX0359 + 1 x Blanking Plate (Right) + D.P. Switch (I/O)  
 B2 = 1 x VS0002 + 1 x Blanking Plate  
 B3 = 1 x FX0359 + 1 x Blanking Plate + D.P. High Inrush Switch (I/O)  
 B5 = 1 x VS0001 + 1 x Blanking Plate + D.P. Switch (I/O)

## Vertical Module Arrangement



BZV04/Z0000/04

- Inlet with 2.8mm or 6.3mm tags
- Fuseholder/Voltage Selector/Indicator options/Blanking plate

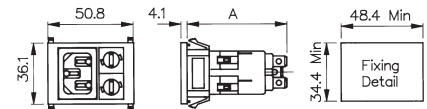

BZV03, BZV04/\*\*\*\*/\*\* A = 62.5 With Filter,  
39.0 Without Filter.

BZV05, BZV06/\*\*\*\*/\*\* A = 39.0.

Panel Thickness: 1.0, 1.5, 2.0, 3.0mm.

## How to order -

**BZV XX****XXXXX****XX****Type of Inlet / Outlet**

C14 Power Inlet (cold condition), 6.3 or 2.8mm tabs:  
03 = PX0575/63  
04 = PX0575/28

C16 Power Inlet (hot condition), 6.3 or 2.8mm tabs:  
05 = PX0595/63  
06 = PX0595/28

Please note type 05 and 06 are not available in filtered version

**Filtered or Non Filtered Inlet**

Z0000 = Non Filtered

Axxxx = Standard

For Filtered inlet use 6th to 9th characters from filter ordering code see page 178  
E.g. BZV03/A0120/04

**Combination of Other Components**

Twin Fuseholder:  
04 = 2 x FX0359

Voltage Selector and Fuseholder:  
14 = 1 x VS0001 + 1 x FX0359

Voltage selector and Neon:  
37 = 1 x VS0001 + DX0928/110V/Red  
38 = 1 x VS0001 + DX0928/110V/Green  
39 = 1 x VS0001 + DX0928/250V/Red  
40 = 1 x VS0001 + DX0928/250V/Green

Fuseholder and Neon:  
41 = 1 x FX0359 + DX0928/110V/Red  
42 = 1 x FX0359 + DX0928/110V/Green  
43 = 1 x FX0359 + DX0928/250V/Red  
44 = 1 x FX0359 + DX0928/250V/Green

Fuseholder and Blanking Plate:  
45 = 1 x FX0359 + Blanking Plate

Voltage Selector and Blanking Plate:  
B2 = 1 x VS0001 + Blanking Plate

Vertical Module Arrangement



BZV49/Z0000/69

- Inlet with 4.8mm or 6.3mm tags
- Single Pole Switch marked I/O
- Illuminated, red or green, switches
- High inrush non-illuminated switch

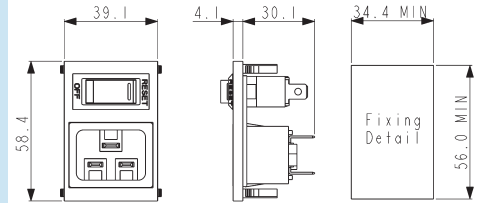

**How to order -**



**Type of Inlet / Outlet**

C20 Power Inlet (cold condition), 4.8 or 6.3mm tabs:

49 = PX0598/63  
 50 = PX0598/48

**Filtered or Non Filtered Inlet**

Z0000 = Non Filtered

**Combination of Other Components**

Single Pole Switch:  
 01 = S.P. Switch

Single Pole Switch Marked (I/O):  
 69 = S.P. Switch (I/O)

Single Pole Illuminated Switch:  
 02 = S.P. Illuminated Red  
 08 = S.P. Illuminated Green

Single Pole Non-illuminated High Inrush Switch Marked I/O:

98 = S.P. High Inrush Switch (I/O)  
 Single Pole Illuminated (Red or Green 250v Neon) Switch Marked I/O:

71 = S.P. Switch Illuminated Red (I/O)  
 74 = S.P. Switch Illuminated Green (I/O)

## Vertical Module Arrangement



BZV09/Z0000/04

- Inlet/Outlet Combination
- 2.8mm or 6.3mm tabs
- Filtered Inlet and Blanking Plate options
- Shuttered or Non-shuttered Outlet
- Fused

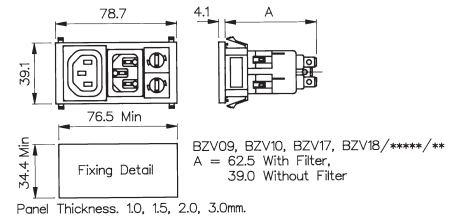

## How to order -

**BZV XX****XXXXX****XX****Type of Inlet / Outlet**

C14 Power Inlet (cold condition) and Sheet F  
 Non-shuttered Power Outlet, 2.8 or 6.3mm tabs:

09 = PX0575/63 + PX0695/63  
 10 = PX0575/28 + PX0695/28

C14 Power Inlet (cold condition) and Sheet F  
 Shuttered Power Outlet, 2.8 or 6.3mm tabs:

17 = PX0575/63 + PX0783/63  
 18 = PX0575/28 + PX0783/28

**Filtered or Non Filtered Inlet**

Z0000 = Non Filtered

Axxxx = Standard

For Filtered inlet use 6th to 9th characters from  
 filter ordering code see page 178  
 E.g. BZV09/A0120/04

**Combination of Other Components**

Twin Fuseholder:  
 04 = 2 x FX0359

Voltage Selector and Fuseholder:  
 14 = 1 x VS0001 + 1 x FX0359

Voltage selector and Neon:  
 37 = 1 x VS0001 + DX0928/110V/Red  
 38 = 1 x VS0001 + DX0928/110V/Green  
 39 = 1 x VS0001 + DX0928/250V/Red  
 40 = 1 x VS0001 + DX0928/250V/Green

Fuseholder and Neon:  
 41 = 1 x FX0359 + DX0928/110V/Red  
 42 = 1 x FX0359 + DX0928/110V/Green  
 43 = 1 x FX0359 + DX0928/250V/Red  
 44 = 1 x FX0359 + DX0928/250V/Green

Fuseholder and Blanking Plate:  
 45 = 1 x FX0359 + Blanking Plate

Voltage Selector and Blanking Plate:  
 B2 = 1 x VS0001 + Blanking Plate

Vertical Module Arrangement



BZV45/Z0000/02

- Outlet with 2.8mm or 6.3mm tags
- Shuttered or Non-Shuttered
- Single Pole Switch or Neon Indicator
- I/O Marking Options

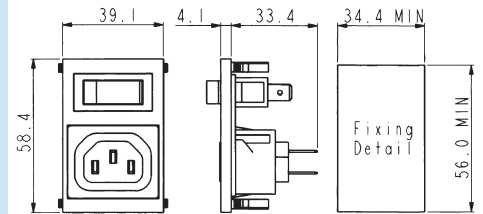

**How to order -**



**Type of Inlet / Outlet**

Sheet F Power Outlet (non shuttered), 6.3 or 2.8mm tabs:

45 = PX0695/63  
 46 = PX0695/28

Sheet F Power Outlet (shuttered), 6.3 or 2.8mm tabs:

47 = PX0783/63  
 48 = PX0783/28

**Filtered or Non Filtered Inlet**

Z0000 = Non Filtered

**Combination of Other Components**

Single Pole Switch:  
 01 = S.P. Switch

Single Pole Neon Switch:  
 02 = S.P. Red Neon Switch  
 08 = S.P. Green Neon Switch

Neon Indicator:  
 03 = Red Neon Indicator

Single Pole High Inrush Switch:  
 46 = S.P. High Inrush Switch

Single Pole Switch Marked I/O:  
 69 = S.P. Switch (I/O)

Single Pole Neon Switch Marked (I/O):  
 71 = S.P. Red Neon Switch (I/O)  
 74 = S.P. Green Neon Switch (I/O)

Single Pole High Inrush Switch Marked (I/O):  
 98 = S.P. High Inrush Switch (I/O)

## Horizontal Module Arrangement



BZH01/Z0000/01

- Fused Inlet with 2.8mm or 6.3mm tags
- Single Pole Switch Variations
- Filtered Inlet Option
- Options of I/O marked switches

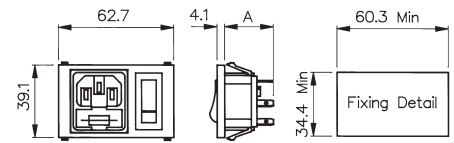

BZH01/\*\*\*\*/\* } A = 59.7 With Filter  
 BZH02/\*\*\*\*/\* } A = 27.4 Without Filter  
 BZH15/\*\*\*\*/\* } A = 59.7 With Filter  
 BZH16/\*\*\*\*/\* } A = 37.9 Without Filter  
 Panel Thickness. 1.0, 1.5, 2.0, 3.0mm

## How to order -

**BZH XX****XXXXX****XX****Type of Inlet / Outlet**

Single Fused C14 Power Inlet (cold condition),  
2.8 or 6.3mm tabs:

01 = PF0011/63  
02 = PF0011/28

Twin Fused C14 Power Inlet (cold condition),  
2.8 or 6.3mm tabs:

15 = PF0033/63  
16 = PF0033/28

**Filtered or Non Filtered Inlet**

Z0000 = Non Filtered

Axxxx = Standard

For Filtered inlet use 6th to 9th characters from  
filter ordering code see pages 179-180  
E.g. BZH01/A0620/01

**Combination of Other Components**

Single Pole Switch:  
01 = S.P. Switch

Single Pole Neon Switch:  
02 = S.P. Red Neon Switch  
08 = S.P. Green Neon Switch

Neon Indicator:  
03 = Red Neon Indicator

Single Pole High Inrush Switch:  
46 = S.P. High Inrush Switch

Single Pole Switch Marked I/O:  
69 = S.P. Switch (I/O)

Single Pole Neon Switch Marked (I/O):  
71 = S.P. Red Neon Switch (I/O)  
74 = S.P. Green Neon Switch (I/O)

Single Pole High Inrush Switch Marked (I/O):  
98 = S.P. High Inrush Switch (I/O)



## Horizontal Module Arrangement



BZH01/Z0000/10

- Fused Inlet with 2.8mm or 6.3mm tags
- Double Pole Switch Variations
- Filtered Inlet Option
- Options of I/O marked switches

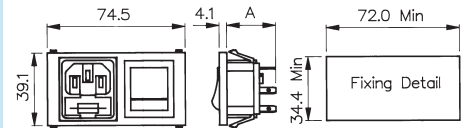

BZH01/\*\*\*\*\*/\*\* } A = 59.7 With Filter  
 BZH02/\*\*\*\*\*/\*\* } A = 27.4 Without Filter  
 BZH15/\*\*\*\*\*/\*\* } A = 59.7 With Filter  
 BZH16/\*\*\*\*\*/\*\* } A = 37.9 Without Filter  
 Panel Thickness. 1.0, 1.5, 2.0, 3.0mm

## How to order -

**BZH XX****XXXXX****XX****Type of Inlet / Outlet**

Single Fused C14 Power Inlet (cold condition),  
2.8 or 6.3mm tabs:

01 = PF0011/63  
02 = PF0011/28

Twin Fused C14 Power Inlet (cold condition),  
2.8 or 6.3mm tabs:

15 = PF0033/63  
16 = PF0033/28

**Filtered or Non Filtered Inlet**

Z0000 = Non Filtered

Axxxx = Standard

For Filtered inlet use 6th to 9th characters from  
filter ordering code see pages 179-180  
E.g. BZH01/A0620/10

**Combination of Other Components**

Neon Indicator:  
03 = Red Neon Indicator

Double Pole Switch:  
10 = D.P. Switch

Double Pole Neon Switch:  
11 = D.P. Red Neon Switch  
12 = D.P. Green Neon Switch

Double Pole High Inrush Switch:  
13 = D.P. High Inrush Switch

Double Pole Switch marked I/O:  
70 = D.P. Switch (I/O)

Double Pole Neon Switch Marked (I/O):  
76 = D.P. Red Neon Switch (I/O)  
77 = D.P. Green Neon Switch (I/O)

Double Pole High Inrush Switch Marked  
(I/O):  
78 = D.P. High Inrush Switch (I/O)  
B1 = D.P. High Inrush Green Neon Switch  
(I/O)

## Horizontal Module Arrangement



BZH09/Z0000/01

- Inlet/Outlet Combination with 2.8mm or 6.3mm tags
- Shuttered or Non-Shuttered Outlet
- Single Pole Switch Variations
- Filtered Inlet Option
- Options of I/O marked switches

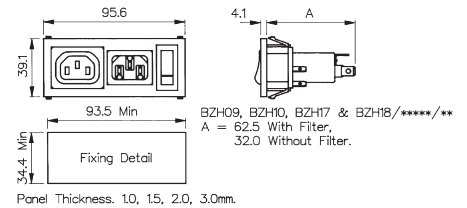

## How to order -

**BZH XX****XXXXX****XX****Type of Inlet / Outlet**

C14 Power Inlet (cold condition) and Sheet F  
 Non-shuttered Power Outlet, 2.8 or 6.3mm tabs:

09 = PX0575/63 + PX0695/63  
 10 = PX0575/28 + PX0695/28

C14 Power Inlet (cold condition) and Sheet F  
 Shuttered Power Outlet, 2.8 or 6.3mm tabs:

17 = PX0575/63 + PX0783/63  
 18 = PX0575/28 + PX0783/28

**Filtered or Non Filtered Inlet**

Z0000 = Non Filtered

Axxxx = Standard

For Filtered inlet use 6th to 9th characters from  
 filter ordering code see page 178  
 E.g. BZH09/A0120/01

**Combination of Other Components**

Single Pole Switch:  
 01 = S.P. Switch

Single Pole Neon Switch:  
 02 = S.P. Red Neon Switch  
 08 = S.P. Green Neon Switch

Neon Indicator:  
 03 = Red Neon Indicator

Single Pole High Inrush Switch:  
 46 = S.P. High Inrush Switch

Single Pole Switch Marked I/O:  
 69 = S.P. Switch (I/O)

Single Pole Neon Switch Marked (I/O):  
 71 = S.P. Red Neon Switch (I/O)  
 74 = S.P. Green Neon Switch (I/O)

Single Pole High Inrush Switch Marked (I/O):  
 98 = S.P. High Inrush Switch (I/O)

## Horizontal Module Arrangement



BZH11/Z0000/10

- Inlet/Outlet Combination with 2.8mm or 6.3mm tags
- Single or Twin Fused Inlet
- Shuttered or Non-Shuttered Outlet
- Double Pole Switch Variations
- Filtered Inlet Option
- Options of I/O marked switches

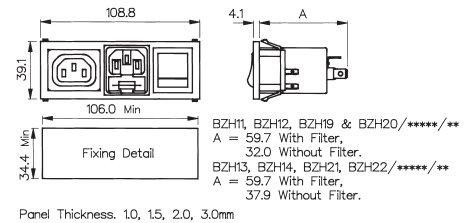

## How to order -

**BZH XX****XXXXX****XX****Type of Inlet / Outlet**

Single Fused C14 Power Inlet (cold condition) and Sheet F Power Outlet, 2.8 or 6.3mm tabs:

11 = PF0011/63 + PX0695/63  
 12 = PF0011/28 + PX0695/28

Twin Fused C14 Power Inlet (cold condition) and Sheet F Power Outlet, 2.8 or 6.3mm tabs:

13 = PF0033/63 + PX0695/63  
 14 = PF0033/28 + PX0695/28

Single Fused C14 Power Inlet (cold condition) and Sheet F Shuttered Power Outlet, 2.8 or 6.3mm tabs:

19 = PF0011/63 + PX0783/63  
 20 = PF0011/28 + PX0783/28

Twin Fused C14 Power Inlet (cold condition) and Sheet F Shuttered Power Outlet, 2.8 or 6.3mm tabs:

21 = PF0033/63 + PX0783/63  
 22 = PF0033/28 + PX0783/28

**Filtered or Non Filtered Inlet**

Z0000 = Non Filtered

Axxxx = Standard

For Filtered inlet use 6th to 9th characters from filter ordering code see pages 179-180  
 E.g. BZH11/A0620/10

**Combination of Other Components**

Neon Indicator:  
 D3 = Red Neon Indicator

Double Pole Switch:  
 10 = D.P. Switch

Double Pole Neon Switch:  
 11 = D.P. Red Neon Switch  
 12 = D.P. Green Neon Switch

Double Pole High Inrush Switch:  
 13 = D.P. High Inrush Switch

Double Pole Switch Marked I/O:  
 70 = D.P. Switch (I/O)

Double Pole Neon Switch Marked (I/O):  
 76 = D.P. Red Neon Switch (I/O)  
 77 = D.P. Green Neon Switch (I/O)

Double Pole High Inrush Switch Marked (I/O):  
 78 = D.P. High Inrush Switch (I/O)  
 B1 = D.P. High Inrush Green Neon Switch (I/O)

## Horizontal Module Arrangement



BZH11/Z0000/00

- Fused Inlet/Outlet
- Combination with 2.8mm or 6.3mm tabs
- Filtered Inlet Option
- Single or Twin Fused

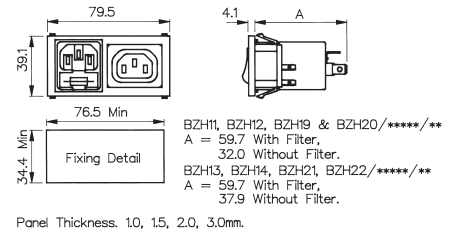

## How to order -

**BZH XX****XXXXX****XX****Type of Inlet / Outlet**

Single Fused C14 Power Inlet (cold condition) and Sheet F Non-shuttered Power Outlet, 2.8 or 6.3mm tabs:

11 = PF0011/63 + PX0695/63  
 12 = PF0011/28 + PX0695/28

Twin Fused C14 Power Inlet (cold condition) and Sheet F Non-shuttered Power Outlet, 2.8 or 6.3mm tabs:

13 = PF0033/63 + PX0695/63  
 14 = PF0033/28 + PX0695/28

Single Fused C14 Power Inlet (cold condition) and Sheet F Shuttered Power Outlet, 2.8 or 6.3mm tabs:

19 = PF0011/63 + PX0783/63  
 20 = PF0011/28 + PX0783/28

Twin Fused C14 Power Inlet (cold condition) and Sheet F Shuttered Power Outlet, 2.8 or 6.3mm tabs:

21 = PF0033/63 + PX0783/63  
 22 = PF0033/28 + PX0783/28

**Filtered or Non Filtered Inlet**

Z0000 = Non Filtered

Axxxx = Standard

For Filtered inlet use 6th to 9th characters from filter ordering code see pages 179-180  
 E.g. BZH11/A0620/00

**Combination of Other Components**

None

00 = None

## Minimum Combined Bezel Size



BZM27/Z0000/57B

- Inlet with 2.8, 4.8 or 6.3mm tags
- Horizontal Module Arrangement
- Single and Double Pole Switch Variations
- Filtered Inlet Option

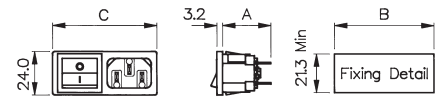

Panel Thickness 1.0, 1.5, 2.0, 3.0mm

 BZM27/\*\*\*\*\*/\*\*\* } A = 63.5 With Filter.  
 BZM28/\*\*\*\*\*/\*\*\* } A = 29.1 Without Filter.

 B = 54.9 With D.P. Switch. 45.9 With S.P. Switch.  
 C = 57.5 With D.P. Switch. 48.5 With S.P. Switch.

## How to order -

**BZM XX****/ XXXXX****/ XX****/ X****Type of Inlet / Outlet**

C14 Power Inlet (cold condition), 6.3, 4.8 &amp; 2.8mm tabs:

 27 = PX0575/63  
 42 = PX0575/48  
 28 = PX0575/28
**Filtered or Non Filtered Inlet**

Z0000 = Non Filtered

Axxxx = Standard

 For Filtered inlet use 6th to 9th characters from filter ordering code see page 178  
 E.g. BZM27/A0120/57B
**Switch Variation**

Single Pole Switch, 4.8mm or solder tab, marked I/O:

 53 = S.P. Switch, 4.8mm tab (I/O)  
 54 = S.P. Switch, solder tab (I/O)

Single Pole Illuminated Switch, 4.8mm or solder tab:

 55 = S.P. Switch Illum. Red, 4.8mm tab  
 61 = S.P. Switch Illum. Green, 4.8mm tab  
 56 = S.P. Switch Illum. Red, solder tab  
 62 = S.P. Switch Illum. Green, solder tab

Double Pole Switch, 4.8mm or solder tab, marked I/O:

 57 = D.P. Switch, 4.8mm tab (I/O)  
 58 = D.P. Switch, solder tab (I/O)

Double Pole Illuminated Switch, 4.8mm or solder tab:

 59 = D.P. Switch Illum. Red, 4.8mm tab  
 63 = D.P. Switch Illum. Green, 4.8mm tab  
 60 = D.P. Switch Illum. Red, solder tab  
 64 = D.P. Switch Illum. Green, solder tab

Double Pole High Inrush, 4.8mm tabs:

65 = D.P. High Inrush Switch, 4.8mm tabs (S.P. format)

Double Pole High Inrush, 4.8mm tabs, marked I/O:

68 = D.P. High Inrush Switch, 4.8mm tabs, I/O (S.P. format)

Single Pole Illuminated Switch, 4.8mm or solder tab,

Marked I/O:

 A1 = S.P. Switch Illum. Red, 4.8mm tab (I/O)  
 A5 = S.P. Switch Illum. Green, 4.8mm tab (I/O)  
 A2 = S.P. Switch Illum. Red, solder tab (I/O)  
 A6 = S.P. Switch Illum. Green, solder tab (I/O)

Double Pole Illuminated Switch, 4.8mm or solder tab,

Marked I/O:

 A3 = D.P. Switch Illum. Red, 4.8mm tab  
 A7 = D.P. Switch Illum. Green, 4.8mm tab  
 A4 = D.P. Switch Illum. Red, solder tab  
 A8 = D.P. Switch Illum. Green, solder tab
**Panel Thickness**

1.0mm = A

1.5mm = B

2.0mm = C

3.0mm = D

## Vertical Module Arrangement



BVA01/Z0000/02

- Fused Inlet with 2.8mm or 6.3mm tags
- Screw Fixing to Panel
- Single Pole Switch Variations
- Filtered Inlet Option
- Options of I/O marked switches

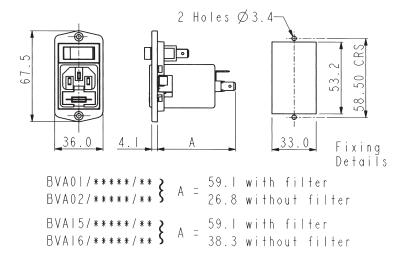

## Vertical Module Arrangement



BVB01/Z0000/01

- Fused Inlet with 2.8mm or 6.3mm tags
- Screw Fixing to Panel
- Single Pole Switch Variations
- Filtered Inlet Option
- Options of I/O marked switches

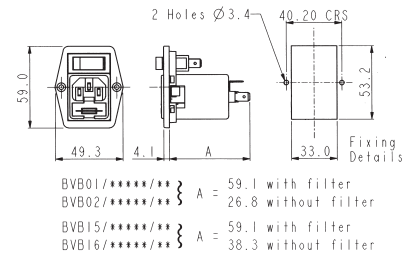

## How to order -

BV X	XX	/	XXXXX	/	XX
<b>Flange Type</b> A = Top fixing B = Side fixing	<b>Type of Inlet / Outlet</b> Single Fused C14 Power Inlet (cold condition), 6.3 or 2.8mm tabs: 01 = PF0011/63 02 = PF0011/28 Twin Fused C14 Power Inlet (cold condition), 6.3 or 2.8mm tabs: 15 = PF0033/63 16 = PF0033/28	<b>Filtered or Non Filtered Inlet</b> Z0000 = Non Filtered Axxxx = Standard For Filtered inlet use 6th to 9th characters from filter ordering code see pages 179-180 E.g. BVA01/A0620/01	<b>Combination of Other Components</b> Single Pole Switch: 01 = S.P. Switch Single Pole Neon Switch: 02 = S.P. Red Neon Switch 08 = S.P. Green Neon Switch Neon Indicator: 03 = Red Neon Indicator Single Pole High Inrush Switch: 46 = S.P. High Inrush Switch Single Pole Switch Marked I/O: 69 = S.P. Switch (I/O) Single Pole Neon Switch Marked (I/O): 71 = S.P. Red Neon Switch (I/O) 74 = S.P. Green Neon Switch (I/O) Single Pole High Inrush Switch Marked (I/O): 98 = S.P. High Inrush Switch (I/O)		

Vertical Module Arrangement



BVA01/Z0000/10

- Fused Inlet with 2.8mm or 6.3mm tags
- Screw Fixing to Panel
- Double Pole Switch Variations
- Filtered Inlet Option
- Options of I/O marked switches

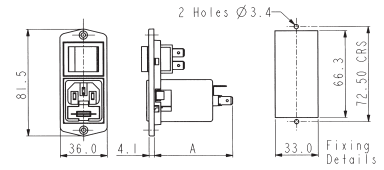

BVA01/\*\*\*\*\*/\*\* } A = 60.9 with filter  
 BVA02/\*\*\*\*\*/\*\* } A = 26.8 without filter  
 BVA15/\*\*\*\*\*/\*\* } A = 60.9 with filter  
 BVA16/\*\*\*\*\*/\*\* } A = 38.3 without filter

Vertical Module Arrangement



BVB01/Z0000/11

- Fused Inlet with 2.8mm or 6.3mm tags
- Screw Fixing to Panel
- Double Pole Switch Variations
- Filtered Inlet Option
- Options of I/O marked switches

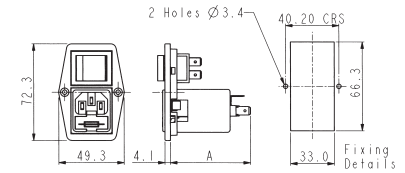

BVB01/\*\*\*\*\*/\*\* } A = 60.9 with filter  
 BVB02/\*\*\*\*\*/\*\* } A = 26.8 without filter  
 BVB15/\*\*\*\*\*/\*\* } A = 60.9 with filter  
 BVB16/\*\*\*\*\*/\*\* } A = 38.3 without filter

How to order -

BV X	XX	/	XXXXX	/	XX
<p><b>Flange Type</b></p> <p>A = Top fixing                      B = Side fixing</p>	<p><b>Type of Inlet / Outlet</b></p> <p>Fused C14 Power Inlet (cold condition), 6.3 or 2.8mm tabs:                      01 = PF0011/63                      02 = PF0011/28</p> <p>Twin Fused C14 Power Inlet (cold condition), 6.3 or 2.8mm tabs:                      15 = PF0033/63                      16 = PF0033/28</p>	<p><b>Filtered or Non Filtered Inlet</b></p> <p>Z0000 = Non Filtered                      Axxxx = Standard</p> <p>For Filtered inlet use 6th to 9th characters from filter ordering code see pages 179-180                      E.g. BVA01/A0620/10</p>	<p><b>Combination of Other Components</b></p> <p>Neon Indicator:                      D3 = Red Neon Indicator</p> <p>Double Pole Switch:                      10 = D.P. Switch</p> <p>Double Pole Neon Switch:                      11 = D.P. Red Neon Switch                      12 = D.P. Green Neon Switch</p> <p>Double Pole High Inrush Switch:                      13 = D.P. High Inrush Switch</p> <p>Double Pole Switch Marked I/O:                      70 = D.P. Switch (I/O)</p> <p>Double Pole Neon Switch Marked (I/O):                      76 = D.P. Red Neon Switch (I/O)                      77 = D.P. Green Neon Switch (I/O)</p> <p>Double Pole High Inrush Switch Marked (I/O):                      78 = D.P. High Inrush Switch (I/O)                      B1 = D.P. High Inrush Green Neon Switch (I/O)</p>		

EMI Filter Options



BVA01/Z0000/10

- For Polysnap modules BZV03, BZV04, BZV09, BZV10, BZV17, BZV18, BZH09, BZH10, BZH17, BZH18, BZM27, BZM28
- PX0575 style IEC inlet
- Using PS01/A style filter
- Standard Attenuation Filter

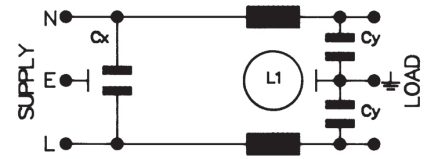

How to order -

<b>B XXXX</b>	<b>/</b>	<b>A</b>	<b>XX</b>	<b>X</b>	<b>X</b>	<b>/</b>	<b>XX</b>
<b>Polysnap Part No.</b>		<b>Filter Type</b>	<b>Rating</b>	<b>L/C Circuit</b>	<b>Additional Components</b>		<b>Polysnap Part No.</b>
From Polysnap Selection		A = Standard	01 = 1A 03 = 3A 06 = 6A 10 = 10A	1 = Version 1 2 = Version 2 3 = Version 3	0 = None		From Polysnap Selection

Rating	Version	L1	Cx	Cy
1 AMP	1	2 x 2.8mH	1 x 15nF	2 x 2.2nF
"	2	2 x 10mH	1 x 15nF	2 x 2.2nF
"	3	2 x 10mH	1 x 47nF	2 x 2.2nF
3 AMP	1	2 x 0.75mH	1 x 15nF	2 x 2.2nF
"	2	2 x 1.8mH	1 x 15nF	2 x 2.2nF
"	3	2 x 1.8mH	1 x 47nF	2 x 2.2nF
6 AMP	1	2 x 0.3mH	1 x 15nF	2 x 2.2nF
"	2	2 x 0.7mH	1 x 15nF	2 x 2.2nF
"	3	2 x 0.7mH	1 x 47nF	2 x 2.2nF
10 AMP	1	2 x 0.17mH	1 x 15nF	2 x 2.2nF
"	2	2 x 0.35mH	1 x 15nF	2 x 2.2nF
"	3	2 x 0.17mH	1 x 47nF	2 x 2.2nF

Part No. Example

[BZV03/A0120/02](#)

BZV style Polysnap module with PX0575 IEC power inlet, filter rated at 1 amp, L/C circuit version 2 (L1 = 2 x 10mH, Cx = 1 x 15nF, Cy = 2 x 2.2nF) 6.3mm tabs and single pole red neon switch.

Filter Specification

<b>Max. Working Voltage:</b>	250V a.c. 50-400Hz
<b>Earth Leakage Current:</b>	<0.35mA (250V, 50Hz)
<b>Temperature Range:</b>	-25°C to +85°C
<b>Max. Ambient Temp. (@ Full Load)</b>	40°C (derate linearly to 0A @ 85°C)
<b>Test Voltage:</b>	2700V d.c. 2 secs. Lines to Earth 1100V d.c. 2 secs. Live to Neutral

**Approvals:** 

**Attenuation Curves:** See PS01/A filter, page 183



## EMI Filter Options



- For Polysnap modules BZV01, BZV02, BZH01, BZH02, BZH11, BZH12, BZH19, BZH20, BVA01, BVA02, BVB01, BVB02
- PF0011 style single fuse IEC inlet
- Using PS21/A style filter
- Standard Attenuation Filter

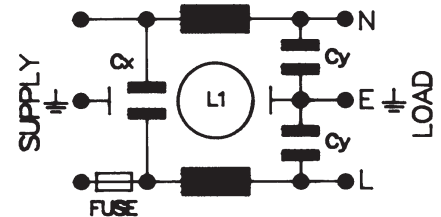

## How to order -

B XXXX	/	A	XX	X	X	/	XX
<b>Polysnap Part No.</b>		<b>Filter Type</b>	<b>Rating</b>	<b>L/C Circuit</b>	<b>Additional Components</b>		<b>Polysnap Part No.</b>
From Polysnap Selection		A = Standard	01 = 1A 03 = 3A 06 = 6A	2 = Version 2 3 = Version 3	0 = None		From Polysnap Selection

Rating	Version	L1	Cx	Cy
1 AMP	1			
"	2			
"	3	2 x 12mH	1 x 47nF	2 x 2.2nF
3 AMP	1			
"	2	2 x 1.8mH	1 x 15nF	2 x 2.2nF
"	3	2 x 6.5mH	1 x 47nF	2 x 2.2nF
6 AMP	1			
"	2	2 x 0.7mH	1 x 15nF	2 x 2.2nF
"	3	2 x 2mH	1 x 47nF	2 x 2.2nF
10 AMP	1			
"	2			
"	3			

## Part No. Example

BZV01/A0630/01

BZV style Polysnap module with PF0011 single fused (5 x 20mm) IEC power inlet, filter rated at 6 amp, L/C circuit version 3 (L1 = 2 x 2.0mH, Cx = 1 x 47nF, Cy = 2 x 2.2nF), 6.3mm tabs and single pole switch.

## Filter Specification

<b>Max. Working Voltage:</b>	250V a.c. 50-400Hz
<b>Earth Leakage Current:</b>	<0.35mA (250V, 50Hz)
<b>Temperature Range:</b>	-25°C to +85°C
<b>Max. Ambient Temp.:</b>	40°C (derate linearly to 0A @ 85°C)
<b>(@ Full Load)</b>	
<b>Test Voltage:</b>	2700V d.c. 2 secs. Lines to Earth 1100V d.c. 2 secs. Live to Neutral

## Approvals:



## Attenuation Curves:

See PS21/A filter, page 187

EMI Filter Option



- For Polysnap modules BZV15, BZV16, BZH13, BZH14, BZH15, BZH16, BZH21, BZH22, BVA15, BVA16, BVB15, BVB16
- PF0033 style twin fuse IEC inlet
- Using PS26/A filter
- Standard Attenuation Filter

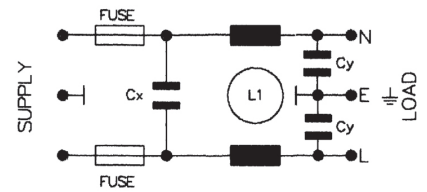

How to order -

<b>B XXXX</b>	<b>/</b>	<b>A</b>	<b>XX</b>	<b>X</b>	<b>X</b>	<b>/</b>	<b>XX</b>
<b>Polysnap Part No.</b>		<b>Filter Type</b>	<b>Rating</b>	<b>L/C Circuit</b>	<b>Additional Components</b>		<b>Polysnap Part No.</b>
From Polysnap Selection		A = Standard	02 = 2A 04 = 4A	2 = Version 2	0 = None		From Polysnap Selection

Rating	Version	L1	Cx	Cy
1 AMP	1			
"	2			
"	3	2 x 1.8mH	1 x 15nF	2 x 2.2nF
4 AMP	1			
"	2	2 x 0.7mH	1 x 15nF	2 x 2.2nF
"	3			

Part No. Example

[BZH13/A0420/00](#)

BZH style Polysnap module with PF0033 twin fused (5 x 20mm) IEC power inlet, filter rated at 4 amps, L/C circuit version 2 (L1 = 2 x 0.7mH, Cx = 1 x 15nF, Cy = 2 x 2.2nF) 6.3mm tabs and no additional components.

Filter Specification

<b>Max. Working Voltage:</b>	250V a.c. 50-400Hz
<b>Earth Leakage Current:</b>	<0.35mA (250V, 50Hz)
<b>Temperature Range:</b>	-25°C to +85°C
<b>Max. Ambient Temp.: (@ Full Load)</b>	40°C (derate linearly to 0A @ 85°C)
<b>Test Voltage:</b>	2700V d.c. 2 secs. Lines to Earth 1100V d.c. 2 secs. Live to Neutral

Approvals:

Attenuation Curves: See PS26/A filter, page 189



Designed to reduce conducted mains borne EMI, this extensive range provides many solutions to EMI problems. To meet individual design requirements the filters are available with two attenuation options – standard and medical. Current ratings are from 1 to 10 amps with single or twin fused types also available.

The choice of mounting options will suit most applications with flange, snap to panel or base/bulkhead.

Flange and Snap Fit

PS00 Series	292-293
PS01 Series	292-293

Base Mounting and Bulkhead

PS02 Series	294-295
PS03 Series	294-295

Fused Inlets

PS20 Series	296-297
PS21 Series	296-297
PS25 Series	298-299
PS26 Series	298-299

Panel Mounting



Flange PS00/A

- 1, 3, 6 or 10 Amp Current Rating
- 3 Alternative Circuits
- No additional components
- 6.3mm tabs

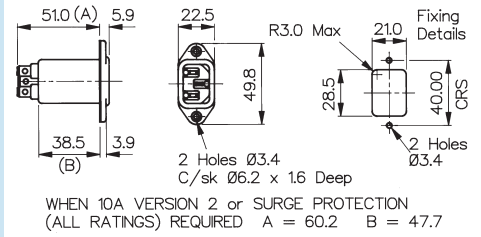

Snap Fit



Snap Fit PS01/A

- 1, 3, 6 or 10 Amp Current Rating
- 3 Alternative Circuits
- No additional components
- 6.3mm tabs
- 1, 1.5, 2 or 3mm panels

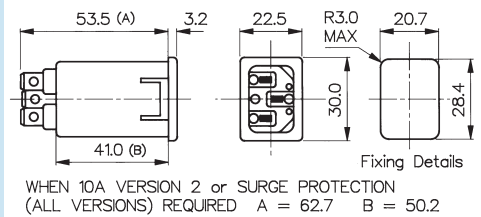

How to order -

PS00/A or PS01/A	XX	X	0	/	63	XX	
<b>Series</b>	<b>Rating</b>	<b>L/C Circuit</b>	<b>Additional Components</b>		<b>Tag Type and Configuration</b>	<b>Panel Thickness</b>	<b>Circuit Board Diagram</b>
PS00/A	01 = 1A	1 = Version 1	0 = None		63 = 6.3mm tabs	00 = Flange	
PS01/A	03 = 3A	2 = Version 2				10 = 1.0mm	
	06 = 6A	3 = Version 3				15 = 1.5mm	
	10 = 10A					20 = 2.0mm	
						30 = 3.0mm	

Specification	PS00/Axxxx/xx00	PS01/Axxxx/xxxx	Part No. Example
Max. Working Voltage:	250V a.c. 50-400Hz	250V a.c. 50-400Hz	<b>PS00/A0120/6300</b>
Earth Leakage Current:	<0.35mA (250V, 50Hz)	<0.35mA (250V, 50Hz)	PS00 series, flange fitting, standard filtered IEC power inlet, rated at 1 ampere. L/C circuit version 2, i.e. L1 = 2 x 10mH, Cx = 15nF, Cy = 2 x 2.2nF. 6.3mm tabs.
Temperature Range:	-25°C to +85°C	-25°C to +85°C	
Max. Ambient Temp: (@ Full Load)	40°C (derate linearly to 0A @ 85°C)	40°C (derate linearly to 0A @ 85°C)	
Test Voltage:	2700V d.c. 2 secs. Lines to Earth 1100V d.c. 2 secs. Live to Neutral	2700V d.c. 2 secs. Lines to Earth 1100V d.c. 2 secs. Live to Neutral	
Approvals:			
Mating Connectors:	PX0587, PX0587/SE, PX0588	PX0587, PX0587/SE, PX0588	
<b>RoHS</b>	Compliant	Compliant	

Rating	Version	L1	Cx	Cy
1 AMP	1	2 x 2.8mH	1 x 15nF	2 x 2.2nF
"	2	2 x 10mH	1 x 15nF	2 x 2.2nF
"	3	2 x 10mH	1 x 47nF	2 x 2.2nF
3 AMP	1	2 x 0.75mH	1 x 15nF	2 x 2.2nF
"	2	2 x 1.8mH	1 x 15nF	2 x 2.2nF
"	3	2 x 1.8mH	1 x 47nF	2 x 2.2nF
6 AMP	1	2 x 0.3mH	1 x 15nF	2 x 2.2nF
"	2	2 x 0.7mH	1 x 15nF	2 x 2.2nF
"	3	2 x 0.7mH	1 x 47nF	2 x 2.2nF
10 AMP	1	2 x 0.17mH	1 x 15nF	2 x 2.2nF
"	2	2 x 0.35mH	1 x 15nF	2 x 2.2nF
"	3	2 x 0.17mH	1 x 47nF	2 x 2.2nF

### Version 1

### Version 2

### Version 3

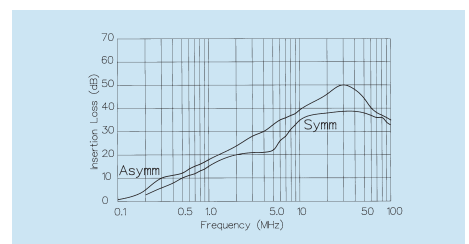
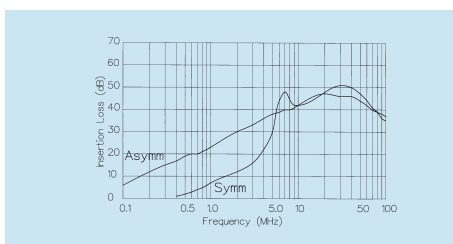
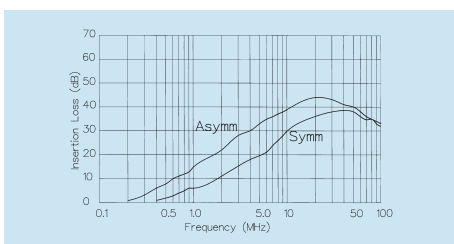
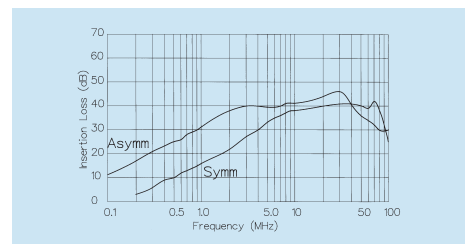
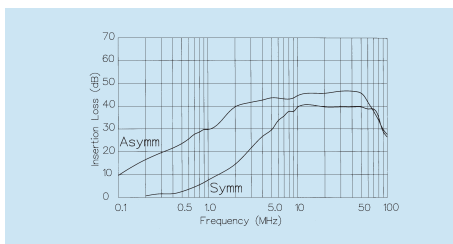
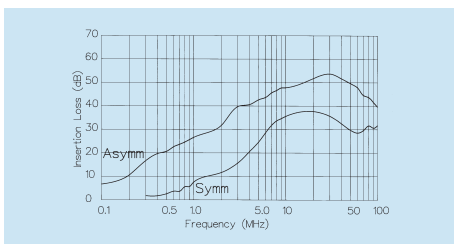
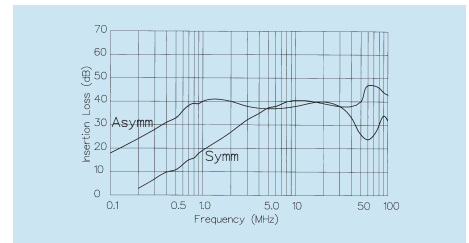
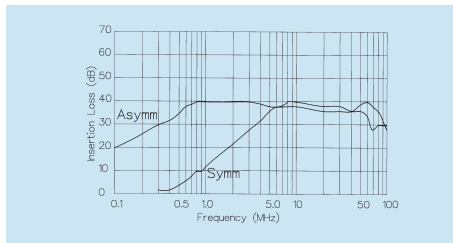
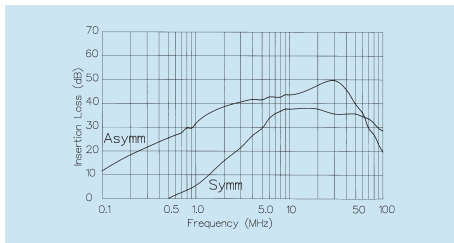
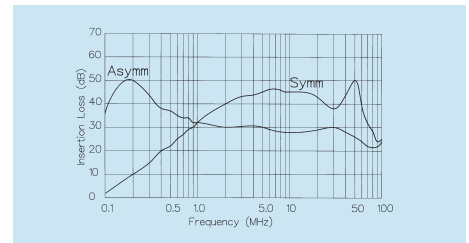
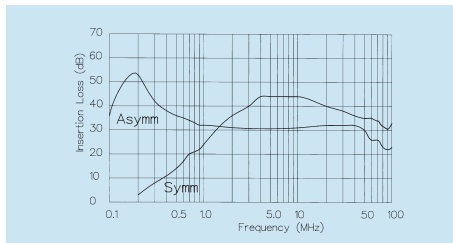
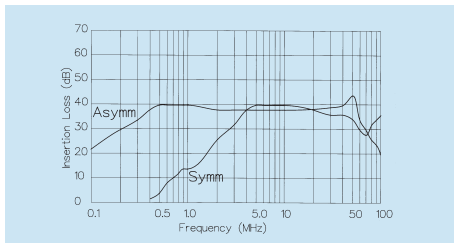

Base Mounting



Base Mounting PS02/A

- 1, 3, 6 or 10 Amp Current Rating
- 3 Alternative Circuits
- No additional components
- 6.3mm tabs

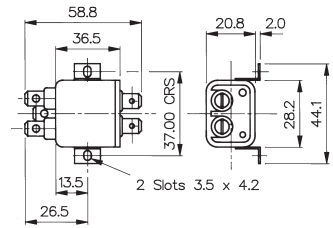

Bulkhead Mounting



Bulkhead Mounting PS03/A

- 1, 3, 6 or 10 Amp Current Rating
- 3 Alternative Circuits
- No additional components
- 6.3mm tabs

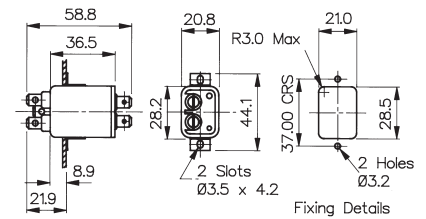

How to order -

PS02/A or PS03/A	<b>XX</b>	<b>X</b>	<b>0</b>	<b>/</b>	<b>63</b>
------------------------	-----------	----------	----------	----------	-----------

Series	Rating	L/C Circuit	Additional Components	Tag Type and Configuration	Circuit Board Diagram
PS02/A	01 = 1A	1 = Version 1	0 = None	63 = 6.3mm tabs	
PS03/A	03 = 3A	2 = Version 2			
	06 = 6A	3 = Version 3			
	10 = 10A				

Specification	PS02/Axxxx/xx	PS03/Axxxx/xx	Part No. Example
Max. Working Voltage:	250V a.c. 50-400Hz	250V a.c. 50-400Hz	PS02/A0120/63
Earth Leakage Current:	<0.35mA (250V, 50Hz)	<0.35mA (250V, 50Hz)	PS02 series, standard base mounting filter, rated at 3 amperes. L/C circuit version 1, i.e. L1 = 2 x 0.75mH, Cx = 15nF, Cy = 2 x 2.2nF with 2.8mm tabs.
Temperature Range:	-25°C to +85°C	-25°C to +85°C	
Max. Ambient Temp: (@ Full Load)	40°C (derate linearly to 0A @ 85°C)	40°C (derate linearly to 0A @ 85°C)	
Test Voltage:	2700V d.c. 2 secs. Lines to Earth 1100V d.c. 2 secs. Live to Neutral	2700V d.c. 2 secs. Lines to Earth 1100V d.c. 2 secs. Live to Neutral	
Approvals:			
<b>RoHS</b>	Compliant	Compliant	

Rating	Version	L1	Cx	Cy
1 AMP	1	2 x 2.8mH	1 x 15nF	2 x 2.2nF
"	2	2 x 10mH	1 x 15nF	2 x 2.2nF
"	3	2 x 10mH	1 x 47nF	2 x 2.2nF
3 AMP	1	2 x 0.75mH	1 x 15nF	2 x 2.2nF
"	2	2 x 1.8mH	1 x 15nF	2 x 2.2nF
"	3	2 x 1.8mH	1 x 47nF	2 x 2.2nF
6 AMP	1	2 x 0.3mH	1 x 15nF	2 x 2.2nF
"	2	2 x 0.7mH	1 x 15nF	2 x 2.2nF
"	3	2 x 0.7mH	1 x 47nF	2 x 2.2nF
10 AMP	1	2 x 0.17mH	1 x 15nF	2 x 2.2nF
"	2	2 x 0.35mH	1 x 15nF	2 x 2.2nF
"	3	2 x 0.17mH	1 x 47nF	2 x 2.2nF

### Version 1

### Version 2

### Version 3

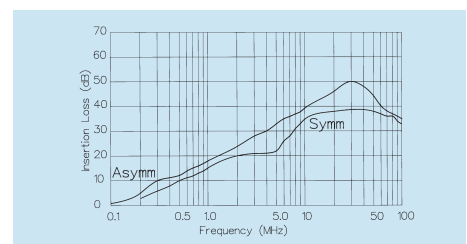
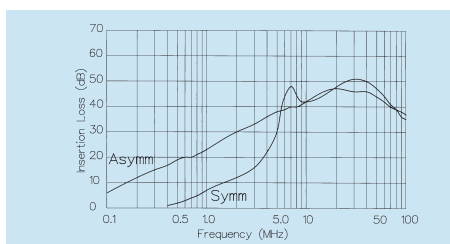
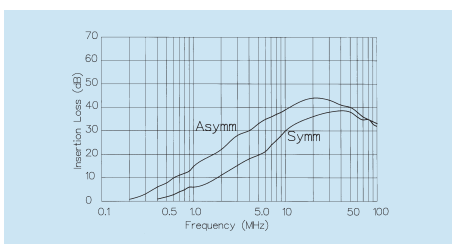
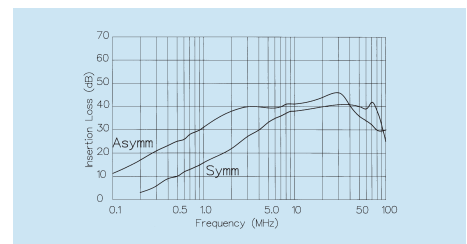
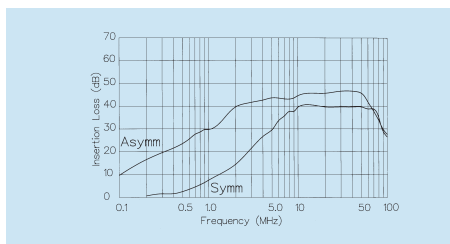
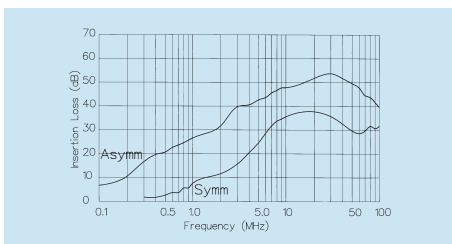
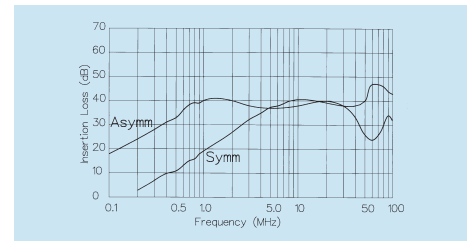
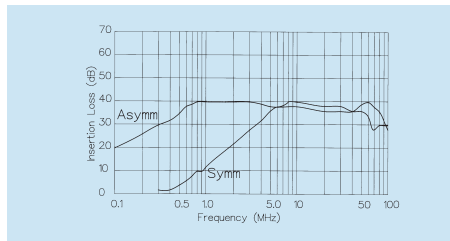
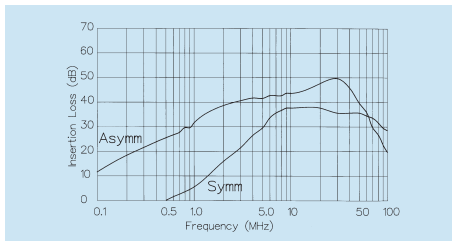
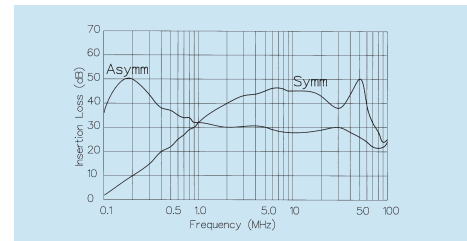
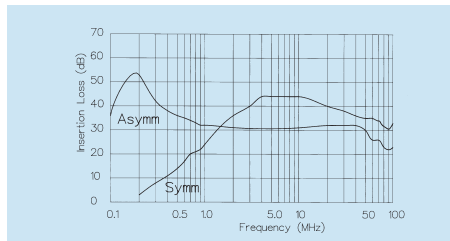
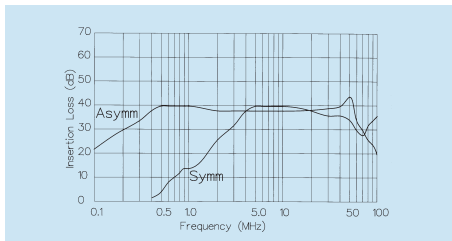

# Mains Filters IEC Power Inlets (Single Fused)



## Panel Mounting

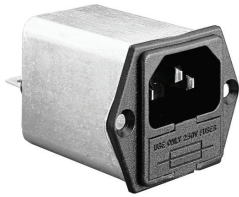

PS20/A

- 1, 3, or 6 Amp Current Rating
- Single Fused
- 2 Alternative Circuits
- 6.3mm tabs

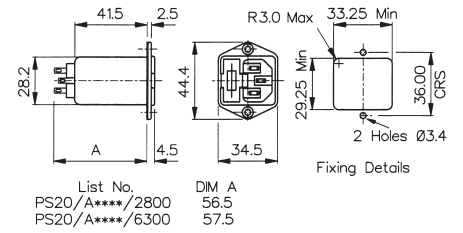

## Snap Fit

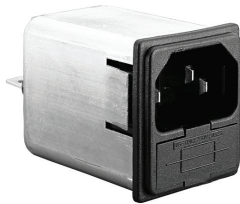

PS21/A

- 1, 3, or 6 Amp Current Rating
- Single Fused
- 2 Alternative Circuits
- 6.3mm tabs
- 1, 1.5, 2 or 3mm panels

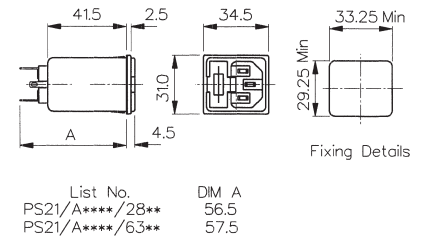

## How to order -

PS02/A or PS03/A	<b>XX</b>	<b>X</b>	<b>0</b>	/	<b>63</b>	/	<b>XX</b>	
<b>Series</b>	<b>Rating</b>	<b>L/C Circuit</b>	<b>Additional Components</b>		<b>Tag Type and Configuration</b>		<b>Panel Thickness</b>	<b>Circuit Board Diagram</b>
PS00/A	01 = 1A	2 = Version 2	0 = None		63 = 6.3mm tabs		00 = Flange	
PS01/A	03 = 3A	3 = Version 3					10 = 1.0mm	
	06 = 6A						15 = 1.5mm	
							20 = 2.0mm	
							30 = 3.0mm	

Specification	PS20/Axxx0/xx00	PS21/Axxx0/xxxx	Part No. Example
Max. Working Voltage:	250V a.c. 50-400Hz	250V a.c. 50-400Hz	PS20/A0620/63
Earth Leakage Current:	<0.35mA (250V, 50Hz)	<0.35mA (250V, 50Hz)	PS20 series, flange fitting, standard filtered IEC power inlet, single fused, rated at 6 amperes.
Temperature Range:	-25°C to +85°C	-25°C to +85°C	L/C circuit version 2, i.e L1 = 2 x 0.7mH, Cx = 1 x 15nF, Cy = 2 x 2.2nF. 6.3mm tabs.
Max. Ambient Temp: (@ Full Load)	40°C (derate linearly to 0A @ 85°C)	40°C (derate linearly to 0A @ 85°C)	
Test Voltage:	2700V d.c. 2 secs. Lines to Earth 1100V d.c. 2 secs. Live to Neutral	2700V d.c. 2 secs. Lines to Earth 1100V d.c. 2 secs. Live to Neutral	
Approvals:			
<b>RoHS</b>	Compliant	Compliant	



Mains Filters  
**PS20/Axxx0/xx00 & PS21/Axxx0/xxxx**

Rating & Version Table



Rating	Version	L1	Cx	Cy
1 AMP	1			
"	2			
"	3	2 x 10mH	1 x 47nF	2 x 2.2nF
3 AMP	1			
"	2	2 x 1.8mH	1 x 15nF	2 x 2.2nF
"	3	2 x 6.5mH	1 x 47nF	2 x 2.2nF
6 AMP	1			
"	2	2 x 0.7mH	1 x 15nF	2 x 2.2nF
"	3	2 x 2mH	1 x 47nF	2 x 2.2nF

**Version 2**

**Version 3**

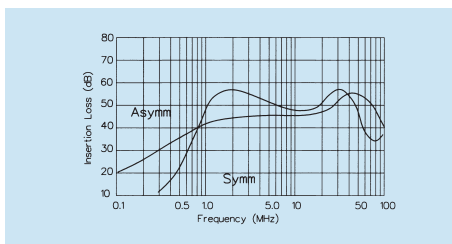
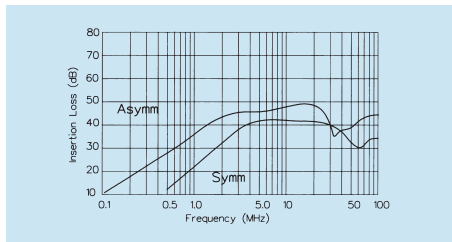
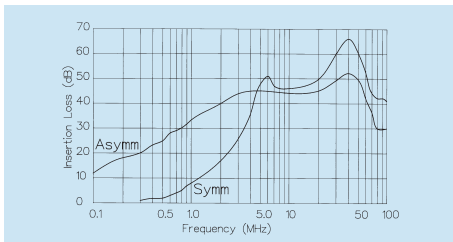
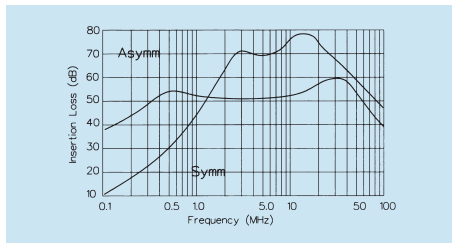
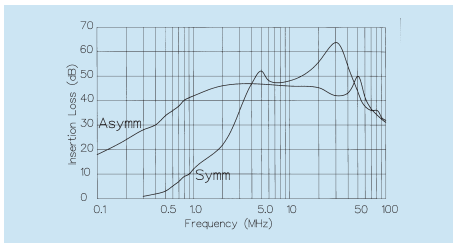

### Base Mounting

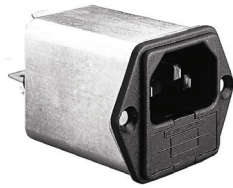

PS25/A

- 2 or 4 Amp Current Rating
- Twin Fused
- No additional components
- 6.3mm tabs

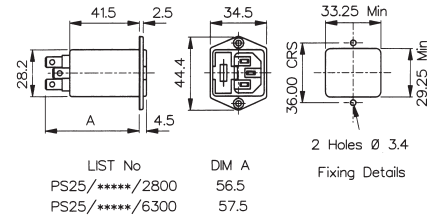

### Snap Fit



PS26/A

- 2 or 4 Amp Current Rating
- Twin Fused
- No additional components
- 6.3mm tabs
- 1, 1.5, 2 or 3mm panels

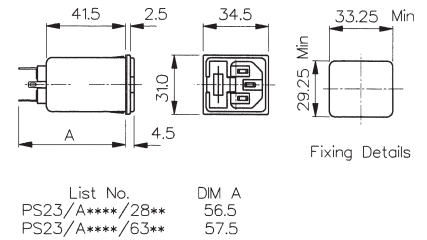

### How to order -

PS25/A or PS26/A	<b>X</b>	<b>2</b>	<b>0</b>	<b>/</b>	<b>63</b>	<b>/</b>	<b>XX</b>
<b>Series</b>	<b>Rating</b>	<b>L/C Circuit</b>	<b>Additional Components</b>	<b>Tag Type and Configuration</b>	<b>Panel Thickness</b>	<b>Circuit Board Diagram</b>	
PS25/A	02 = 2A	2 = Version 2	0 = None	63 = 6.3mm tabs	00 = Flange		
PS26/A	04 = 4A				10 = 1.0mm		
					15 = 1.5mm		
					20 = 2.0mm		
					30 = 3.0mm		

Specification	PS25/Axx2x/xx00	PS26/Axx2x/xxxx	Part No. Example
Max. Working Voltage:	250V a.c. 50-400Hz	250V a.c. 50-400Hz	PS20/A0620/63
Earth Leakage Current:	2.5W per fuse	2.5W per fuse	PS20 series, flange fitting, standard filtered IEC power inlet, single fused, rated at 6 amperes. L/C circuit version 2, i.e L1 = 2 x 0.7mH, Cx = 1 x 15nF, Cy = 2 x 2.2nF. 6.3mm tabs.
Temperature Range:	<0.35mA (250V, 50Hz)	<0.35mA (250V, 50Hz)	
Max. Ambient Temp: (@ Full Load)	40°C (derate linearly to 0A @ 85°C)	40°C (derate linearly to 0A @ 85°C)	
Test Voltage:	2700V d.c. 2 secs. Lines to Earth 1100V d.c. 2 secs. Live to Neutral	2700V d.c. 2 secs. Lines to Earth 1100V d.c. 2 secs. Live to Neutral	
Approvals:			
Mating Connectors	PX0587, PX0587/SE, PX0588	PX0587, PX0587/SE, PX0588	
Accessories	P.No. 14340 (see page 151)	P.No. 14340 (see page 151)	
<b>RoHS</b>	Compliant	Compliant	

# Mains Filters PS25/Axx2x/xx00 & PS26/Axx2x/xxxx

Rating & Version Table



Rating	Version	L1	Cx	Cy
1 AMP	1			
"	2	2 x 1.8mH	1 x 15nF	2 x 2.2nF
"	3			
3 AMP	1			
"	2	2 x 0.7mH	1 x 15nF	2 x 2.2nF
"	3			

## Version 2

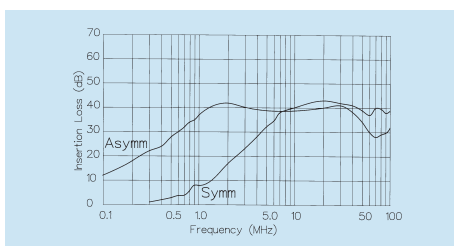
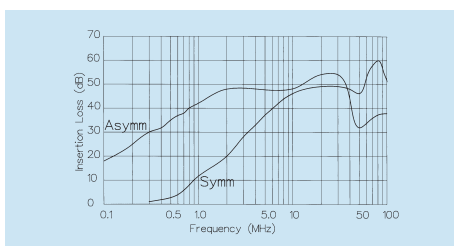

Bulgin's **extensive range** of fuseholders are **designed** to give the degree of **protection** demanded in today's sophisticated electronic equipment. Carrying world-wide safety approvals from **UL**, **VDE**, **CSA** and **IMQ**, all types are manufactured from high grade flame retardant **nylon** and **polyester** materials.

Designed primarily for 5 x 20mm and 6.3 x 32mm size fuses with protection against shock to categories PC1, PC2 and PC3. There's a choice of styles for in-line, PCB mounting and panel mounting (screw or snap fit) with terminal options for solder, 2.8mm, 4.8mm or 6.3mm tabs or PC spills. Dust and waterproof designs provide a front of panel seal to IP68 in both 5 x 20mm and 6.3 x 32mm size fuses.

Fuse carrier styles include captive drawer, screw cap - with screw driver release, bayonet cap - with screw driver release and screw cap - with finger release.

Panel Mounting	302-308
IP68 Panel Mounting	309
IP66 Panel Mounting	310
PC Mounting	311-312
Base Mounting	313
In-line	314-315



### Category PC1:

No integral protection against electric shock. If required, Designers/Manufacturers must provide additional protection against electric shock on equipment.

### Category PC2:

With integral protection against electric shock. Fuseholders shall have live parts inaccessible to IEC 60529 Standard Test Finger, when fully assembled, without fuse carrier or fuse in place and when fuse carrier, with fuse is being inserted or withdrawn.

### Category PC3:

With integral protection against electric shock. Fuseholders shall have live parts inaccessible to IEC 60529 1mm dia. rigid test wire when fully assembled, without fuse carrier or fuse in place and when fuse carrier, with fuse, is being inserted or withdrawn.



Snap Fit to Panel



FX0430/63

- Protection Category PC3
- Fuse Size 5 x 20mm
- Panel Sizes 1.0, 1.5, 2.0 and 3.0mm
- Captive Drawer
- 10A, 250V (16A, 250V UL)
- 2.8, 4.8 or 6.3 tabs

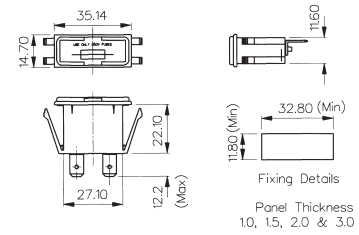

Snap Fit to Panel



FX0430/PC

- Protection Category PC3
- Fuse Size 5 x 20mm
- Panel Sizes 1.0, 1.5, 2.0 and 3.0mm
- Captive Drawer
- 10A, 250V (16A, 250V UL)
- PC spills

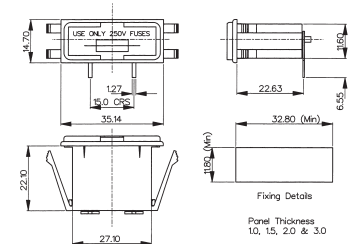

Specifications	FX0430/Termination	FX0430/PC
Fuse Size:	5 x 20mm	5 x 20mm
Fuse Carrier:	Captive Drawer	Captive Drawer
Terminations:	/28 (2.8mm solder), /48 (4.8mm tab), /63 (6.3mm tab)	/PC (PC spills)
Max. Rating:	10A, 250V (16A, 250V a.c. UL)	10A, 250V (16A, 250V a.c. UL)
Max. Power Dissipation:	2.5W (@ 23°C)	2.5W (@ 23°C)
Insulation Resistance:	>10MΩ @ 500V d.c.	>10MΩ @ 500V d.c.
A.C. Breakdown:	>2kV	>2kV
Contact Resistance:	<10mΩ	<10mΩ
Operating Temp:	-20°C to +85°C (ambient air temp + fuse temp rise)	-20°C to +85°C (ambient air temp + fuse temp rise)
Mouldings:		
Body/Drawer:	Nylon UL94V-0 rated	Nylon UL94V-0 rated
Cap:		
Nut:		
Contacts:	Contact tags: Brass, Tin Plated Fuse Clips: Phosphor Bronze, Nickel Plated	Contact tags: Brass, Tin Plated Fuse Clips: Phosphor Bronze, Nickel Plated
Approvals:		
Accessories:		
Note:		
<b>RoHS</b>	Compliant	Compliant

Panel Mount



FX0357

FX0359

- Protection Category PC2
- Fuse Size 5 x 20mm
- Bayonet Cap/Screwdriver Release
- 10A, 250V (16A, 250V UL)

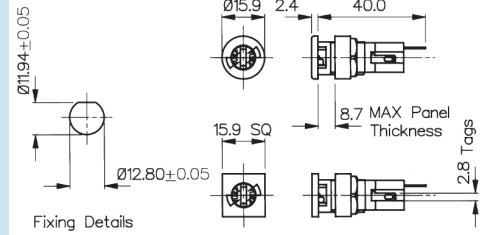

Snap Fit to Panel



FX0367

FX0369

- Protection Category PC2
- Fuse Size 5 x 20mm
- Panel Sizes 1.0 & 1.5 and 2.0 & 3.0mm
- Bayonet Cap/Screwdriver Release
- 10A, 250V (16A, 250V UL)

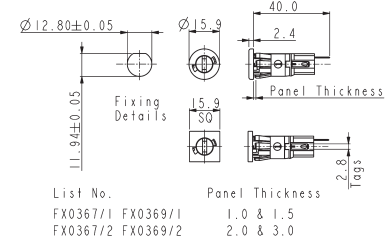

Specifications	FX0357, FX0359	FX0367/Panel, FX0369/Panel
Fuse Size:	5 x 20mm	5 x 20mm
Panel Size:		/1 (1.0-1.5mm panel, black sleeve) /2 (2.0-3.0mm panel, grey sleeve)
Fuse Carrier:	Bayonet cap/Screwdriver release	Bayonet cap/Screwdriver release
Terminations:	Solder tags	Solder tags
Max. Rating:	10A, 250V (16A, 250V a.c. UL)	10A, 250V (16A, 250V a.c. UL)
Max. Power Dissipation:	2.5W (@ 23°C)	2.5W (@ 23°C)
Insulation Resistance:	>10 <sup>2</sup> MΩ @ 500V d.c.	>10 <sup>2</sup> MΩ @ 500V d.c.
A.C. Breakdown:	7kV @ 50Hz	7kV @ 50Hz
Contact Resistance:	<10mΩ	<10mΩ
Operating Temp:	-20°C to +85°C (ambient air temp + fuse temp rise)	-20°C to +85°C (ambient air temp + fuse temp rise)
Mouldings:		
Body:	Polyester UL94V-0 rated	Polyester UL94V-0 rated
Cap:	Nylon UL94V-0 rated	Nylon UL94V-0 rated
Nut:	Glass Filled Nylon UL94V-0 rated	
Contacts:	Brass, Silver Plated	Brass, Silver Plated
Approvals:		
Accessories:	P.No. 11327 (See page 206)	P.No. 11327 (See page 205)
<b>RoHS</b>	Compliant	Compliant

Panel Mount



FX0454, FX0455

- Protection Category PC2
- Fuse Size 5 x 20mm
- Screw Cap/Screwdriver Release
- Keyway Panel Cutout (FX0454)
- D Panel Cutout (FX0455)
- 10A, 250V (16A, 250V UL)

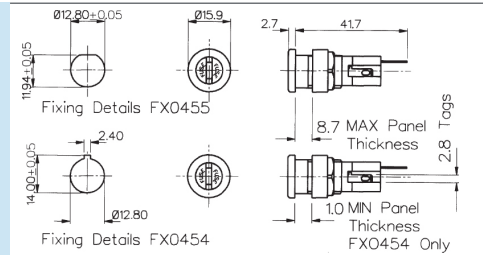

Panel Mount



FX0454/S, FX0455/S

- Protection Category PC2
- Fuse Size 5 x 20mm
- Screw Cap/Screwdriver Release
- High Profile Bezel
- Keyway Panel Cutout (FX0454/S)
- D Panel Cutout (FX0455/S)
- 10A, 250V (16A, 250V UL)

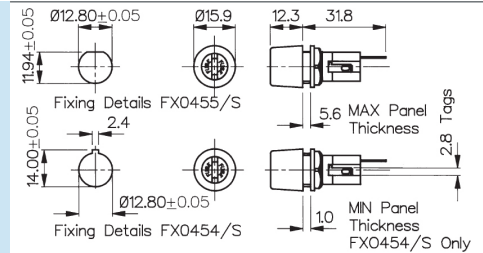

Snap Fit to Panel



FX0458

- Protection Category PC2
- Fuse Size 5 x 20mm
- Panel Sizes 1.0 & 1.5 and 2.0 & 3.0mm
- Screw Cap/Screwdriver Release
- 10A, 250V (16A, 250V UL)

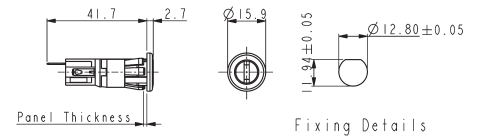

List No.	Panel Thickness
FX0458/1	1.0 & 1.5
FX0458/2	2.0 & 3.0

Specifications	FX0454, FX0455	FX0454/S, FX0455/S	FX0458
Fuse Size:	5 x 20mm	5 x 20mm	5 x 20mm
Panel Size:			/1 (1.0-1.5mm panel, black sleeve) /2 (2.0-3.0mm panel, grey sleeve)
Fuse Carrier:	Screw cap/Screwdriver release	Screw cap/Screwdriver release	Screw cap/Screwdriver release
Terminations:	Solder tags	Solder tags	Solder tags
Max. Rating:	10A, 250V (16A, 250V a.c. UL)	10A, 250V (16A, 250V a.c. UL)	10A, 250V (16A, 250V a.c. UL)
Max. Power Dissipation:	2.5W (@ 23°C)	2.5W (@ 23°C)	2.5W (@ 23°C)
Insulation Resistance:	>10 <sup>9</sup> MΩ @ 500V d.c.	>10 <sup>9</sup> MΩ @ 500V d.c.	>10 <sup>9</sup> MΩ @ 500V d.c.
A.C. Breakdown:	7kV @ 50Hz	7kV @ 50Hz	7kV @ 50Hz
Contact Resistance:	<10mΩ	<10mΩ	<10mΩ
Operating Temp:	-20°C to +85°C (ambient air temp + fuse temp rise)	-20°C to +85°C (ambient air temp + fuse temp rise)	-20°C to +85°C (ambient air temp + fuse temp rise)
Mouldings:			
Body:	Polyester UL94V-0 rated	Polyester UL94V-0 rated	Polyester UL94V-0 rated
Cap:	Nylon UL94V-0 rated	Nylon UL94V-0 rated	Nylon UL94V-0 rated
Nut:	Glass Filled Nylon UL94V-0 rated	Glass Filled Nylon UL94V-0 rated	
Contacts:	Brass, Silver Plated	Brass, Silver Plated	Brass, Silver Plated
Approvals:			
Accessories:	P.Nos. 11327, 12297 & 12298 (See page 206)	P.Nos. 11327, 12297 & 12298 (See page 206)	P.Nos. 11327 (See page 205)
RoHS	Compliant	Compliant	Compliant



Panel Mount



FX0415,

FX0416

- Protection Category PC2
- Fuse Sizes:  
6.3 x 32mm (FX0415)  
6.3 x 25mm (FX0416)
- Screw Cap/Hand Release
- 13A, 250V (16A, 250V UL)

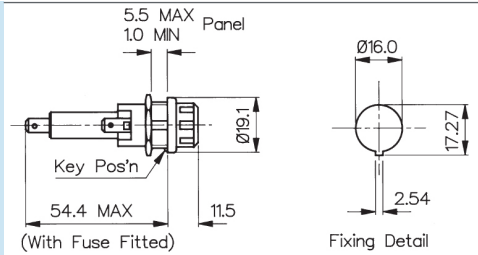

Panel Mount



FX0415/S,

FX0416/S

- Protection Category PC2
- Fuse Sizes:  
6.3 x 32mm (FX0415/S)  
6.3 x 25mm (FX0416/S)
- Screw Cap/Screwdriver Release
- 13A, 250V (16A, 250V UL)

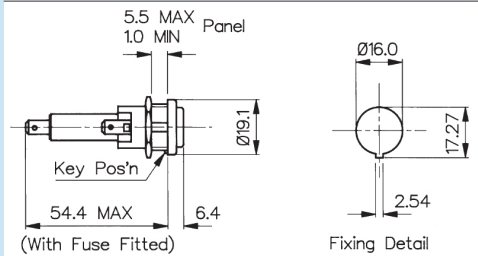

Specifications	FX0415, FX0416	FX0415/S, FX0416/S
Fuse Size:	FX0415 - 6.3 x 32mm FX0416 - 6.3 x 25mm	FX0415/S - 6.3 x 32mm FX0416/S - 6.3 x 25mm
Fuse Carrier:	Screw cap/Hand release	Screw cap/Hand release
Terminations:	4.8 series tabs	4.8 series tabs
Max. Rating:	13A, 250V (16A, 250V UL)	13A, 250V (16A, 250V UL)
Max. Power Dissipation:	4W (@ 23°C)	4W (@ 23°C)
Insulation Resistance:	>10 <sup>5</sup> MΩ @ 500V d.c.	>10 <sup>5</sup> MΩ @ 500V d.c.
A.C. Breakdown:	4kV @ 50Hz	4kV @ 50Hz
Contact Resistance:	<5mΩ	<5mΩ
Operating Temp:	-20°C to +85°C (ambient air temp + fuse temp rise)	-20°C to +85°C (ambient air temp + fuse temp rise)
Mouldings:		
Body:	Glass Filled Nylon UL94V-0 rated	Glass Filled Nylon UL94V-0 rated
Cap:	Nylon UL94V-0 rated	Nylon UL94V-0 rated
Nut:	Polyester UL94V-0 rated	Polyester UL94V-0 rated
Contacts:	Brass, Silver Plated	Brass, Silver Plated
Approvals:		
Accessories:	P.No. 12932 (See page 205)	P.No. 12932 (See page 205)
<b>RoHS</b>	Compliant	Compliant

Panel Mount



FX0354

- Protection Category PC2
- Low Profile Bezel
- Fuse Size 5 x 20mm
- Screw Cap/Screwdriver Release
- Keyway Panel Cutout
- 6.3A, 250V

6.4 MAX Panel  
0.8 MIN PANEL

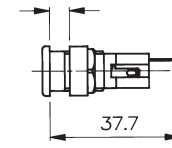

Fixing Details

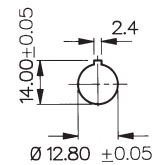

Panel Mount



FX0354/S

- Protection Category PC2
- High Profile Bezel
- Fuse Size 5 x 20mm
- Screw Cap/Screwdriver Release
- Keyway Panel Cutout
- 6.3A, 250V

2.4 MAX Panel  
0.8 MIN PANEL

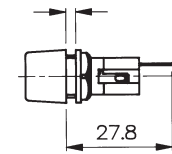

Fixing Details

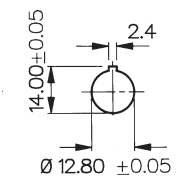

Specifications	FX0354	FX0354/S
Fuse Size:	5 x 20mm	5 x 20mm
Fuse Carrier:	Screw cap/Screwdriver release	Screw cap/Screwdriver release
Terminations:	Solder tags	Solder tags
Max. Rating:	6.3A, 250V	6.3A, 250V
Max. Power Dissipation:	2.5W (@ 23°C)	2.5W (@ 23°C)
Insulation Resistance:	>10 <sup>2</sup> MΩ @ 500V d.c.	>10 <sup>2</sup> MΩ @ 500V d.c.
A.C. Breakdown:	5kV @ 50Hz	5kV @ 50Hz
Contact Resistance:	<10mΩ	<10mΩ
Operating Temp:	-20°C to +85°C (ambient air temp + fuse temp rise)	-20°C to +85°C (ambient air temp + fuse temp rise)
Mouldings:		
Body:	Polyester UL94V-0 rated	Polyester UL94V-0 rated
Cap:	Nylon UL94V-0 rated	Nylon UL94V-0 rated
Nut:	Glass Filled Nylon UL94V-0 rated	Glass Filled Nylon UL94V-0 rated
Contacts:	Brass, Silver Plated	Brass, Silver Plated
Approvals:		
Accessories:	P.No. 11327 and 12298 (See page 205)	P.No. 11327 and 12298 (See page 205)
RoHS	Compliant	Compliant



### Key Features

- 6.3 x 32mm fuses
- Screwdriver slot knob
- PC2 protection category
- 4.8, 6.3 and solder terminals
- Low profile bezel
- Snap in or threaded bushing mounting options

### Approvals and specifications

16A 250Vac (max fuse rating\*) T-55 to T+70 (ambient)  
Maximum dissipation wattage: 4W

6.3A UL 94V2 UL file E92075 CSA file LR44770

These products comply with safety category PC2.  
\*Users should be aware of the de-rating factors published by specialist manufacturers of fuses.

Fuseholders with in-line termination have combination (4.8/6.3) terminals. It has not been possible to show both views here. Units with right angle terminals have user specified end terminals and combination mid-body terminals.



### Terminal

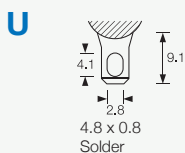
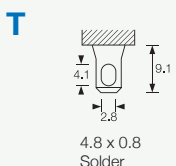
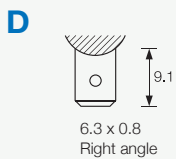
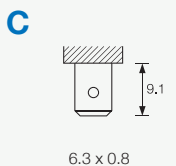

### Body

**0345** (C terminal shown)  
Screwdriver release



**0345** (D terminal shown)  
Screwdriver release



**0347** (T terminal shown)  
Screwdriver release



**0347** (U terminal shown)  
Screwdriver release



### Options

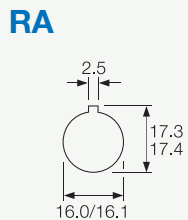

Panel thickness  
0.8 - 2.0mm for snap fit  
0.8 - 7.0mm for screw to panel fixing

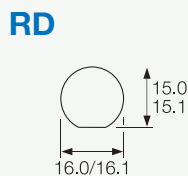

Panel thickness  
0.8 - 2.0mm for snap fit  
0.8 - 7.0mm for screw to panel fixing

### Dimensions

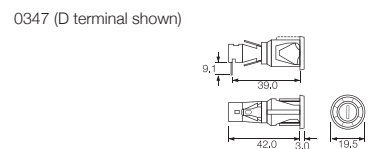
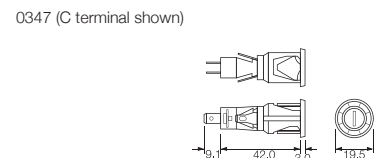
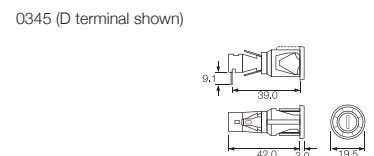
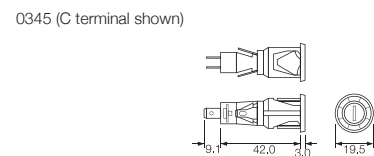

Optional metal fixing nut available for 0347

Panel Mount



FX0296/S

FX0296

- Protection Category PC1
- Fuse Size 5 x 20mm
- Screw Cap/Hand Release
- 6.3A, 250V

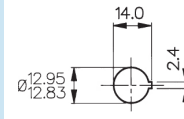

Fixing Details

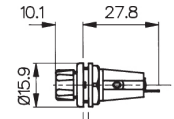

3.2 MAX Panel  
1.0 MIN Panel

Panel Mount



FX0296/1

- Protection Category PC1
- Fuse Size 5 x 20mm
- Screw Cap/Hand Release
- 6.3A, 250V

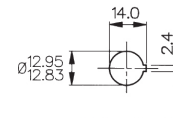

Fixing Details

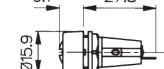
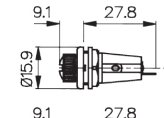

3.2 MAX Panel  
1.0 MIN Panel

Specifications	FX0296, FX0296/S	FX0296/1
Fuse Size:	5 x 20mm	5 x 20mm
Fuse Carrier:	FX0296 Screw cap/Hand release FX0296/S Screw cap/Screwdriver release	Screw cap/Hand release
Terminations:	Solder tags	Solder tags
Max. Rating:	6.3A, 250V	6.3A, 250V
Max. Power Dissipation:	2.5W (@ 23°C)	2.5W (@ 23°C)
Insulation Resistance:	>10 <sup>9</sup> MΩ @ 500V d.c.	>10 <sup>9</sup> MΩ @ 500V d.c.
A.C. Breakdown:	2.5kV @ 50Hz	2.5kV @ 50Hz
Contact Resistance:	<5mΩ	<5mΩ
Operating Temp:	-20°C to +85°C (ambient air temp + fuse temp rise)	-20°C to +85°C (ambient air temp + fuse temp rise)
Mouldings:		
Body:	Glass Filled Nylon UL94V-0 rated Nylon	Glass Filled Nylon UL94V-0 rated Nylon
Cap:	UL94V-0 rated	UL94V-0 rated
Nut:	Glass Filled Nylon UL94V-0 rated	Glass Filled Nylon UL94V-0 rated
Contacts:	Brass, Silver or Tin Plated	Brass, Silver or Tin Plated
Accessories	P.No. 9820 (See page 205)	P.No. 9820 (See page 205)
<b>RoHS</b>	Compliant	Compliant

Panel Mount



FX0419

- Panel sealed to IP68
- Touchproof Category PC2
- Fuse Size 6.3 x 32mm
- Screw cap/Screwdriver/Hand Release
- 16A. 250V ac

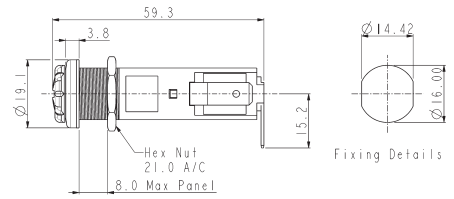

Panel Mount



FX0462

- Panel sealed to IP68
- Touchproof Category PC2
- Fuse Size 5 x 20mm
- Screw cap/Screwdriver/Hand Release
- 10A. 250V ac

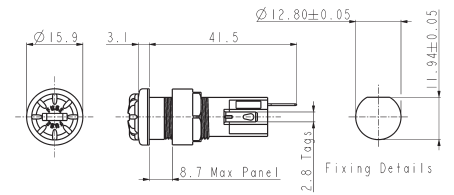

Panel Mount



FX0463

- Panel sealed to IP68
- Touchproof Category PC2
- Fuse Size 5 x 20mm
- High Profile Bezel
- Screw cap/Screwdriver/Hand Release
- 10A. 250V ac

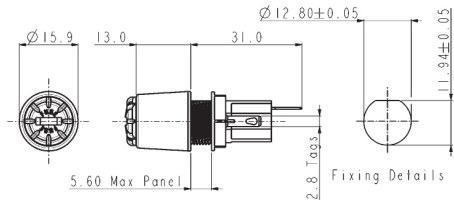

Specifications	FX0419	FX0462	FX0463
Fuse Size:	6.3 x 32mm	5.0 x 20mm	5.0 x 20mm
Fuse Carrier:	Screw cap/Screwdriver/Hand release	Screw cap/Screwdriver/Hand release	Screw cap/Screwdriver/Hand release
Terminations:	6.3 series tabs	Solder tags	Solder tags
Max. Rating:	16A, 250V ac	10A, 250V ac	10A, 250V ac
Max. Power Dissipation:	2.5W (@ 23°C)	2.5W (@ 23°C)	2.5W (@ 23°C)
Insulation Resistance:	>10 <sup>6</sup> MΩ @ 500V d.c.	>10 <sup>6</sup> MΩ @ 500V d.c.	>10 <sup>6</sup> MΩ @ 500V d.c.
A.C. Breakdown:	>2kV @ 50Hz	>7kV @ 50Hz	>7kV @ 50Hz
Contact Resistance:	<10mΩ	<10mΩ	<10mΩ
Operating Temp:	-20°C to +85°C (ambient air temp + fuse temp rise)	-20°C to +85°C (ambient air temp + fuse temp rise)	-20°C to +85°C (ambient air temp + fuse temp rise)
Mouldings:			
Body:	Polyester UL94V-0 rated	Polyester UL94V-0 rated	Polyester UL94V-0 rated
Cap:	Nylon UL94V-0 rated	Nylon UL94V-0 rated	Nylon UL94V-0 rated
Nut:	Glass Filled Nylon UL94V-0 rated	Glass Filled Nylon UL94V-0 rated	Glass Filled Nylon UL94V-0 rated
Contacts:	Brass, Silver Plated	Brass, Silver Plated	Brass, Silver Plated
Tightening Torque:			
Cap:	0.5 - 0.6Nm (4.43-5.3lbf.in.)	0.4 - 0.6Nm (3.54-5.3lbf.in.)	0.4 - 0.6Nm (3.54-5.3lbf.in.)
Panel Nut:	0.5Nm (4.4lbf.in.)	0.5Nm (4.4lbf.in.)	0.5Nm (4.4lbf.in.)
Sealing:	IP68 to EN60529:1992+A2:2013 (10m for 2weeks)	IP68 to EN60529:1992+A2:2013 (10m for 2weeks)	IP68 to EN60529:1992+A2:2013 (10m for 2weeks)
Accessories:		P.nos. 11327 (see page 205)	P.nos. 11327 (see page 205)
Approvals:			
RoHS	Compliant	Compliant	Compliant

High Profile Panel Mount



FX0345

- Sealed to IP66
- Protection Category PC1
- Fuse Size 5 x 20mm
- Screw Cap/Screwdriver Release
- 6.3A, 250V

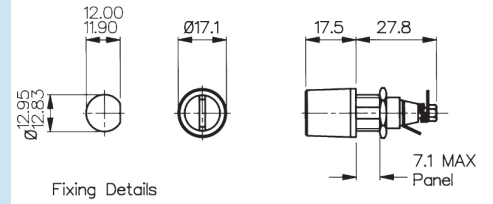

High Profile Panel Mount



FX0365

- Sealed to IP66
- Protection Category PC1
- Fuse Size 5 x 20mm
- Screw Cap/Hand Release
- Large Cap for Easy Grip
- 6.3A, 250V

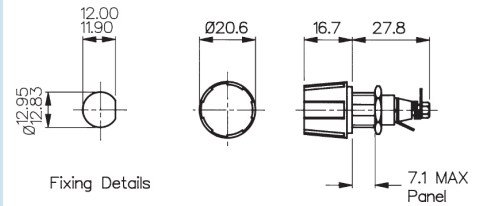

Specifications	FX0345, FX0345/A	FX0365, FX0365/A
Fuse Size:	5 x 20mm	5 x 20mm
Fuse Carrier:	Screw cap/Screwdriver release	Screw cap/Screwdriver release
Terminations:	Solder tags	Solder tags
Max. Rating:	6.3A, 250V	6.3A, 250V
Max. Power Dissipation:	4W (@ 23°C)	4W (@ 23°C)
Insulation Resistance:	>10 <sup>3</sup> MΩ @ 500V d.c.	>10 <sup>3</sup> MΩ @ 500V d.c.
A.C. Breakdown:	>3.5kV @ 50Hz	>3.5kV @ 50Hz
Contact Resistance:	<10mΩ	<10mΩ
Operating Temp:	-20°C to +85°C (ambient air temp + fuse temp rise)	-20°C to +85°C (ambient air temp + fuse temp rise)
Mouldings:		
Body & Cap:	Glass Filled Nylon UL94V-0 rated	Glass Filled Nylon UL94V-0 rated
Spacer:	Glass Filled Nylon UL94HB rated	Glass Filled Nylon UL94HB rated
Insulating Sleeve:	Nylon UL94V-0 rated	Nylon UL94V-0 rated
Contacts:	Brass, Silver Plated	Brass, Silver Plated
Sealing:	Protection Classification IP66 to EN60529:1992+A2:2013 Retains sealing integrity with cap removed since they are both panel and barrier sealed	
Variants:	/A Silicone 'O' ring, Op. Temp. -55°C to +85°C Compliant	/A Silicone 'O' ring, Op. Temp. -55°C to +85°C Compliant

RoHS

PC Horizontal Mount



FX0461

- Protection Category PC3
- Fuse Size 5 x 20mm
- Screw Cap/Screwdriver Release
- Captive Fuse Carrier
- PC Spills
- 10A, 250V (16A, 250V UL)

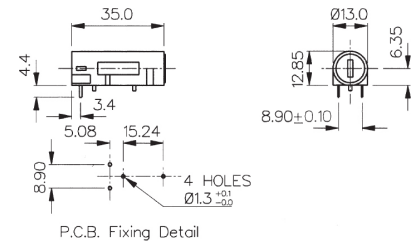

PC Horizontal and Vertical Mount



FX0457

FX0456

- Protection Category PC2
- Fuse Sizes 5 x 20mm
- Bayonet Cap/Screwdriver Release
- 10A, 250V

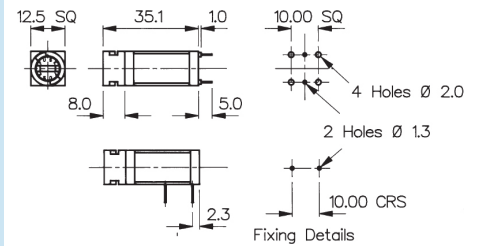

PC Horizontal Mount



FX0330

FX0342

- Protection Category PC1
- Fuse Size 5 x 20mm
- Two or Three PC Spills
- Screw Cap/Hand Release
- 6.3A, 250V

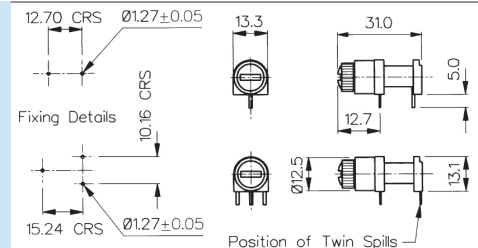

Specifications	FX0461	FX0456 FX0457	FX0330 FX0342
Fuse Size:	5 x 20mm	5 x 20mm	5 x 20mm
Fuse Carrier:	Screw cap/Screwdriver release	Bayonet cap/Screwdriver release	Screw cap/Hand release
Terminations:	PC Spills	PC Spills	FX0330 - 3 PC Spills FX0342 - 2 PC Spills
Max. Rating:	10A, 250V (16A, 250V a.c. UL)	10A, 250V	6.3A, 250V
Max. Power Dissipation:	1.6W (@ 23°C)	2.5W (@ 23°C)	2.5W (@ 23°C)
Insulation Resistance:	>10MΩ @ 500V d.c.	>10 <sup>2</sup> MΩ @ 500V d.c.	>10 <sup>4</sup> MΩ @ 500V d.c.
A.C. Breakdown:	>2kV	4kV @ 50Hz	6kV @ 50Hz
Contact Resistance:	<10mΩ	<10mΩ	<5mΩ
Operating Temp:	-20°C to +85°C (ambient air temp + fuse temp rise)	-20°C to +85°C (ambient air temp + fuse temp rise)	-20°C to +85°C (ambient air temp + fuse temp rise)
Mouldings:			
Body:	Polyester UL94V-0 rated	Polyester UL94V-0 rated	Glass Filled Nylon UL94V-0 rated
Cap:	Nylon UL94V-0 rated	Nylon UL94V-0 rated	Nylon UL94V-0 rated
End Bung:		Polyester UL94V-0 rated	
Contacts:	Brass, Silver Plated	Brass, Silver Plated	Brass, Tin Plated
Approvals:			
RoHS	Compliant	Compliant	Compliant

PC Mount

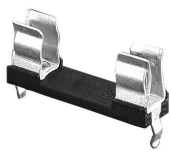

FX0321

- Protection Category PC1
- Fuse Size 5 x 20mm
- PC Spills
- 6.3A, 250V

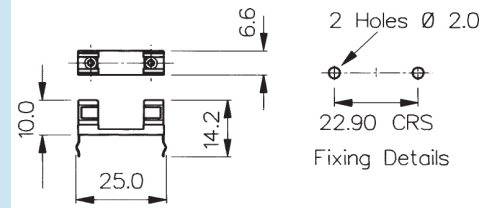

Base Mount



FX0267

- Protection Category PC1
- Fuse Size 5 x 20mm
- Solder Tags
- 6.3A, 250V

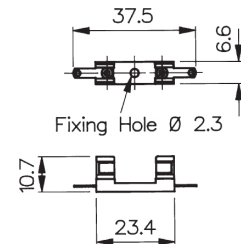

Base Mount



FX0360

- Protection Category PC1
- Fuse Size 5 x 20mm
- Solder Tags
- 6.3A, 250V

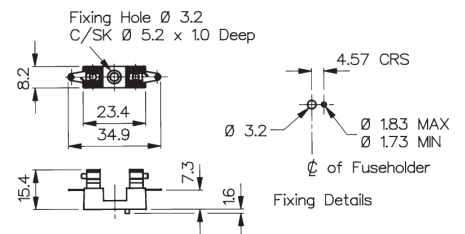

Specifications	FX0321	FX0267	FX0360
Fuse Size:	5 x 20mm	5 x 20mm	5 x 20mm
Terminations:	PC Spills	Solder tags	Solder tags
Max. Rating:	6.3A, 250V	6.3A, 250V	6.3A, 250V
Insulation Resistance:	>10 <sup>5</sup> MΩ @ 500V d.c.	>10 <sup>5</sup> MΩ @ 500V d.c.	>10 <sup>4</sup> MΩ @ 500V d.c.
A.C. Breakdown:	7kV @ 50Hz (Clip to clip)	1.5kV @ 50Hz	2kV @ 50Hz
Contact Resistance:	<10mΩ	<10mΩ	<10mΩ
Operating Temp: (ambient air temp + fuse temp rise)	-20°C to +85°C	-20°C to +85°C	-20°C to +85°C
Base Material:	Glass Filled Nylon UL94V-0 rated	Glass Filled Nylon UL94V-0 rated	Glass Filled Nylon UL94HB rated
Contacts:	Phosphor Bronze, Tin Plated	Phosphor Bronze, Tin Plated	Phosphor Bronze, Tin Plated
Accessories:	P.No. 12760 (See page 205)	P.No. 12760 (See page 205)	
<b>RoHS</b>	Compliant	Compliant	Compliant



Base Mount

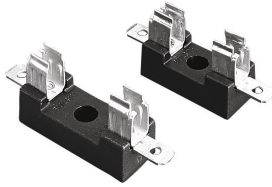

FX0326

FX0331

- Protection Category PC1
- Fuse Sizes:  
6.3 x 32mm (FX0326)  
6.3 x 25mm (FX0331)
- Solder Tags
- 13A, 250V

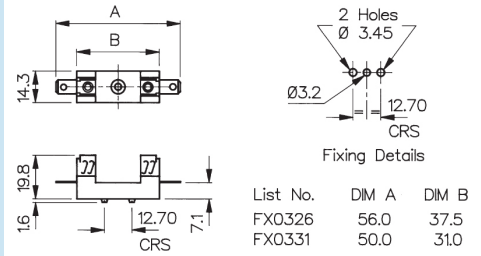

Base Mount

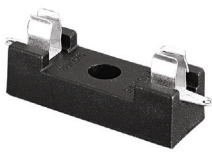

FX0327

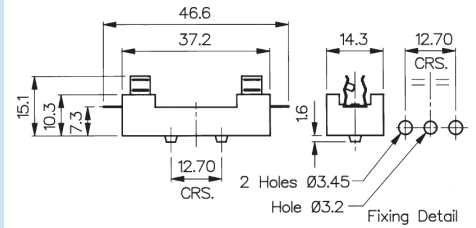

- Protection Category PC1
- Fuse Size 6.3 x 32mm
- Solder Tags
- 5A, 250V

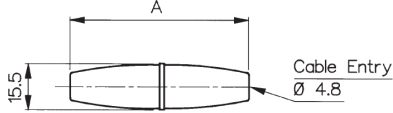

Specifications	FX0326, FX0331	FX0327
Fuse Size:	FX0326 - 6.3 x 32mm FX0331 - 6.3 x 25mm	6.3 x 32mm
Terminations:	6.3 series tabs	Solder tags
Max. Rating:	13A, 250V	5A, 250V
Insulation Resistance:	>10 <sup>4</sup> MΩ @ 500V d.c.	>10 <sup>5</sup> MΩ @ 500V d.c.
A.C. Breakdown:	5kV @ 50Hz	5kV @ 50Hz
Contact Resistance:	<5mΩ	<10mΩ
Operating Temp: (ambient air temp + fuse temp rise)	-20°C to +85°C	-20°C to +85°C
Base Material:	Glass Filled Polyester UL94V-0 rated	Glass Filled Polyester UL94V-0 rated
Contacts:	Clips: Phospher Bronze, Tin Plated Tabs: Brass, Tin Plated	Phospher Bronze, Tin Plated
<b>RoHS</b>	Compliant	Compliant

<p>In-line</p>  <p style="text-align: center;"><b>FX0180, FX0280, FX0380</b></p>	<ul style="list-style-type: none"> <li>○ Protection Category PC1</li> <li>○ Fuse Sizes 5 x 20mm, 6.3 x 25mm and 6.3 x 32mm</li> <li>○ Screw Terminal (Solder to order)</li> <li>○ 10A, 50V (250V Inaccessible)</li> <li>○ UL Approved (Black Only)</li> <li>○ Clear or black</li> </ul>	 <table border="1" style="margin-left: auto; margin-right: auto;"> <thead> <tr> <th>List No.</th> <th>DIM A</th> </tr> </thead> <tbody> <tr> <td>FX0180</td> <td>60.3</td> </tr> <tr> <td>FX0280</td> <td>54.5</td> </tr> <tr> <td>FX0380</td> <td>48.6</td> </tr> </tbody> </table>	List No.	DIM A	FX0180	60.3	FX0280	54.5	FX0380	48.6
List No.	DIM A									
FX0180	60.3									
FX0280	54.5									
FX0380	48.6									

<p>In-line</p>  <p style="text-align: center;"><b>FX0185, FX0285, FX0385</b></p>	<ul style="list-style-type: none"> <li>○ Sealed to IP66</li> <li>○ Protection Category PC1</li> <li>○ Fuse Sizes 5 x 20mm, 6.3 x 25mm and 6.3 x 32mm</li> <li>○ Screw Terminal (Solder to order)</li> <li>○ 10A, 50V (250V Inaccessible)</li> <li>○ UL Approved (Black Only)</li> <li>○ Clear or black</li> </ul>	 <table border="1" style="margin-left: auto; margin-right: auto;"> <thead> <tr> <th>List No</th> <th>DIM A</th> </tr> </thead> <tbody> <tr> <td>FX0185</td> <td>91.0</td> </tr> <tr> <td>FX0285</td> <td>85.2</td> </tr> <tr> <td>FX0385</td> <td>79.2</td> </tr> </tbody> </table>	List No	DIM A	FX0185	91.0	FX0285	85.2	FX0385	79.2
List No	DIM A									
FX0185	91.0									
FX0285	85.2									
FX0385	79.2									

Specifications	FX0180/colour, FX0280.colour, FX0380/Colour	FX0185/Colour, FX0285/colour, FX0385/Colour
Fuse Size:	5 x 20mm FX0380 6.3 x 25mm FX0280 6.3 x 32mm FX0180	5 x 20mm FX0385 6.3 x 25mm FX0285 6.3 x 32mm FX0185
Cable Acceptance:	1mm <sup>2</sup> conductor (max.)	1mm <sup>2</sup> conductor (max.) 1mm to 2.64mm overall diameter Stepped grommet: Stage 1: 1.00mm to 1.40mm Stage 2: 1.50mm to 1.90mm Stage 3: 2.0mm to 2.64mm
Terminations:	Screw terminal (solder to order)	Screw Terminal (solder to order)
Max. Rating:	10A, 50V (250V where inaccessible inside equipment)	10A, 50V (250V where inaccessible inside equipment)
Insulation Resistance:	>10 <sup>5</sup> MΩ @ 500V d.c.	>10 <sup>5</sup> MΩ @ 500V d.c.
High Voltage Proof Test:	2kV (50Hz for 1 minute)	2kV (50Hz for 1 minute)
Contact Resistance:	<10mΩ	<10mΩ
Operating Temp: (ambient air temp + fuse temp rise)	-20°C to +90°C	-20°C to +70°C
Sealing:		Protection Classification IP66 EN60529: 1992+A2:2013
Screw Tightening Torque	0.226Nm (2lb/in)	0.226Nm (2lb/in)
Mouldings:		
Body - Clear:	Polybutene UL94HB rated	Polybutene UL94HB rated
Body - Black:	Nylon 6 UL94V-0 rated	Nylon 6 UL94V-0 rated
Grommet:		PVC
O Ring:		Nitrile
Contacts:		
Terminals:	Brass, Nickel Plated	Brass, Nickel Plated
Grub Screw:	Stainless Steel	Stainless Steel
Approvals:	 (Black version only)	 (Black version only)
Colour:	Clear - no suffix, /BK - Black	Clear - no suffix, /BK - Black
<b>RoHS</b>	Compliant	Compliant



This range of panel mounting LED indicators consists of many different bezel styles, types of LED's and colours. The range has developed to meet the different needs of panel design including IP66 and IP67 environmentally sealed versions for use where a front panel seal is needed.

The vandal resistant LED indicators are designed to complement the vandal resistant switches (see the Switch Section), they have similar profiles with stainless steel bodies, sealing to IP66 & 68 and are built to withstand harsh environments.

Vandal Resistant LED	317-318
LED Bezel	319-323
Indicator Lights	324-330
Low Voltage Lampholders	331-332
LED Lampholders	333-334
Indicator Lights IP67	335

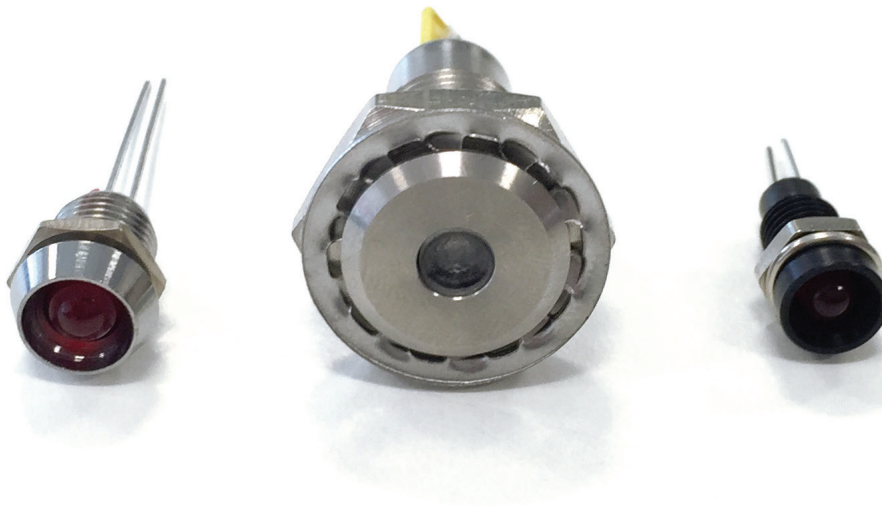

## Proud of Panel Profile



DX0505

- Solder Tag/2.8mm Tag Termination
- Sealed to IP67
- Red, Green, Yellow or Blue LED Options
- Wide Viewing Angle
- Shock and Vibration Resistant
- Stainless Steel body

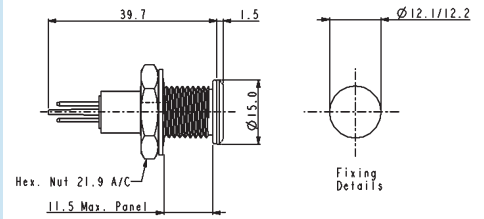

## Flush Panel Profile

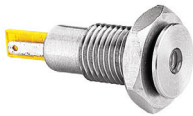

DX0506

- Solder Tag/2.8mm Tag Termination
- Sealed to IP67
- Red, Green, Yellow or Blue LED Options
- Wide Viewing Angle
- Shock and Vibration Resistant
- Stainless Steel body

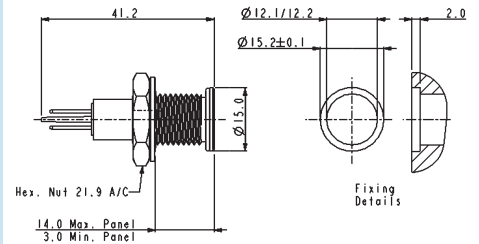

Specifications	DX0505/Col/Voltage	DX0506/Col/Voltage
Terminations:	Solder Tab/2.8mm Tab	Solder Tab/2.8mm Tab
Forward Voltage:	Red 1.85V, Green 2.2V, Yellow 2.0V, Blue 3.8V	Red 1.85V, Green 2.2V, Yellow 2.0V, Blue 3.8V
Cont. Forward Current: (max)	Red 30mA, Green 25mA, Yellow 30mA, Blue 25mA	Red 30mA, Green 25mA, Yellow 30mA, Blue 25mA
Power Dissipation:	Red 100mW, Green 105mW, Yellow 125mW, Blue 120mW	Red 100mW, Green 105mW, Yellow 125mW, Blue 120mW
Reverse Current: (@Vr = 5V)	Red 10µA max., Green 10µA max., Yellow 10µA max., Blue 50µA max.	Red 10µA max., Green 10µA max., Yellow 10µA max., Blue 50µA max.
LED Luminous Intensity:	Red 2000mcd, Green 100mcd, Yellow 400mcd, Blue 1600mcd (typ)	Red 2000mcd, Green 100mcd, Yellow 400mcd, Blue 1600mcd (typ)
Operating Temp. Range:	-40°C to +80°C	-40°C to +80°C
Storage Temperature:	-40°C to +85°C	-40°C to +85°C
Sealing (Front of panel):	Protection Classification IP67 to EN60529:1992+A2:2013	Protection Classification IP67 to EN60529:1992+A2:2013
Materials		
Body:	Stainless Steel	Stainless Steel
Lens:	Polycarbonate UL94V-0	Polycarbonate UL94V-0
O Ring (external):	Nitrile	Nitrile
(internal):	Silicone	Silicone
Tightening Torque	0.5Nm - 0.9Nm (4.4lbf.in. - 8.0lbf.in.)	0.5Nm - 0.9Nm (4.4lbf.in. - 8.0lbf.in.)
Thread Size:	M12 x 1.25-6g	M12 x 1.25-6g
LED Colours:	/RD (Red), /GN (Green), /YL (Yellow) /BL (Blue), with colour coded insulator	/RD (Red), /GN (Green), /YL (Yellow) /BL (Blue), with colour coded insulator
LED Voltage:	/12 (12V d.c.), /24 (24V d.c.) or /00 (no ballast resistor)	/12 (12V d.c.), /24 (24V d.c.) or /00 (no ballast resistor)
RoHS	Compliant	Compliant

## Proud of Panel Profile

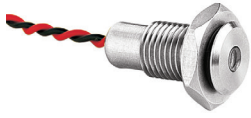

DX0507

- Flying Lead Termination
- Sealed to IP67
- Red, Green, Yellow or Blue LED Options
- Wide Viewing Angle
- Shock and Vibration Resistant
- Stainless Steel body

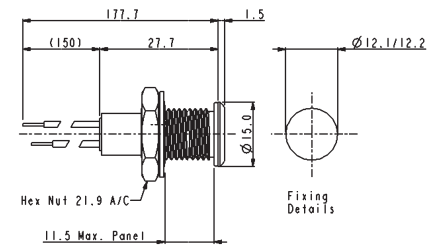

## Flush Panel Profile

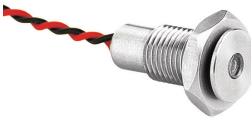

DX0508

- Flying Lead Termination
- Sealed to IP67
- Red, Green, Yellow or Blue LED Options
- Wide Viewing Angle
- Shock and Vibration Resistant
- Stainless Steel body

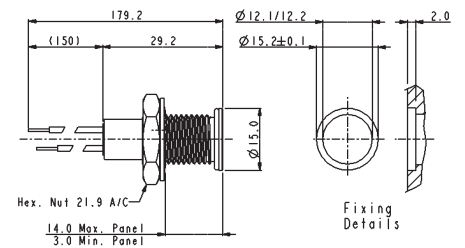

Specifications	DX0507/Col/Voltage	DX0508/Col/Voltage
Terminations:	Flying Leads	Flying Leads
Forward Voltage:	Red 1.85V, Green 2.2V, Yellow 2.0V, Blue 3.8V	Red 1.85V, Green 2.2V, Yellow 2.0V, Blue 3.8V
Cont. Forward Current: (max)	Red 30mA, Green 25mA, Yellow 30mA, Blue 25mA	Red 30mA, Green 25mA, Yellow 30mA, Blue 25mA
Power Dissipation:	Red 100mW, Green 105mW, Yellow 125mW, Blue 120mW	Red 100mW, Green 105mW, Yellow 125mW, Blue 120mW
Reverse Current: (@Vr = 5V)	Red 10µA max., Green 10µA max., Yellow 10µA max., Blue 50µA max.	Red 10µA max., Green 10µA max., Yellow 10µA max., Blue 50µA max.
LED Luminous Intensity:	Red 2000mcd, Green 100mcd, Yellow 400mcd, Blue 1600mcd (typ)	Red 2000mcd, Green 100mcd, Yellow 400mcd, Blue 1600mcd (typ)
Operating Temp. Range:	-40°C to +80°C	-40°C to +80°C
Storage Temperature:	-40°C to +85°C	-40°C to +85°C
Sealing (Front of panel):	Protection Classification IP67 to EN60529:1992+A2:2013	Protection Classification IP67 to EN60529:1992+A2:2013
Materials		
Body:	Stainless Steel	Stainless Steel
Lens:	Polycarbonate UL94V-0	Polycarbonate UL94V-0
O Ring (external):	Nitrile	Nitrile
(internal):	Silicone	Silicone
Tightening Torque	0.5Nm - 0.9Nm (4.4lbf.in. - 8.0lbf.in.)	0.5Nm - 0.9Nm (4.4lbf.in. - 8.0lbf.in.)
Thread Size:	M12 x 1.25-6g	M12 x 1.25-6g
LED Colours:	/RD (Red), /GN (Green), /YL (Yellow) /BL (Blue), with colour coded insulator	/RD (Red), /GN (Green), /YL (Yellow) /BL (Blue), with colour coded insulator
LED Voltage:	/12 (12V d.c.), /24 (24V d.c.) or /00 (no ballast resistor)	/12 (12V d.c.), /24 (24V d.c.) or /00 (no ballast resistor)
RoHS	Compliant	Compliant

Chrome Plated Brass Bezel



DX0998

DX0999

- Chrome Plated Brass Bezel
- Prominent or Recessed Style
- Choice of LED Types and Colours

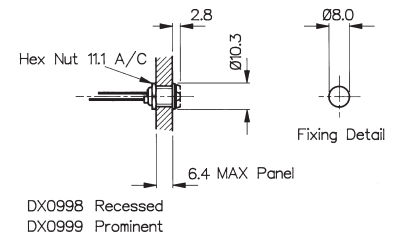

Nylon Bezel



DX1120

DX1121

- Glass Filled Nylon Bezel
- Prominent or Recessed Style
- Choice of LED Types and Colours

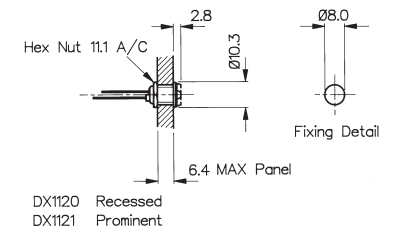

Specifications	DX0998, DX0999/Colour/Options	DX1120, DX1121/Colour/Options
Bezel Material:	Brass, Chrome Plated	Glass Filled Nylon
Style:	Recessed (DX0998) Prominent (DX0999)	Recessed (DX1120) Prominent (DX1121)
Operating Temp. Range:	Dependent on LED used	Dependent on LED used
Storage Temperature:	Dependent on LED used	Dependent on LED used
LED Colours:	/RD (Red), /GN (Green), /YL (Yellow), /BL (Blue), /TR (Tri Colour), /D1 (Dual Colour - Red/Green), /D2 (Dual Colour - Red/Amber), /D3 (Dual Colour - Green/Amber)	/RD (Red), /GN (Green), /YL (Yellow), /BL (Blue), /TR (Tri Colour), /D1 (Dual Colour - Red/Green), /D2 (Dual Colour - Red/Amber), /D3 (Dual Colour - Green/Amber)
LED Options:	/02 (Flashing, Green or Red only)	/02 (Flashing, Green or Red only)
Thread Size:	0.312" x 32TPI	0.312" x 32TPI
<b>RoHS</b>	Compliant	Compliant

See Page 212 for LED options and specifications\*

Aluminium Bezel - IP66 Sealed



DX1090

DX1092

- Aluminium Bezel, Black
- Anodised Finish
- IP66 Front Panel Sealed
- Prominent or Recessed Style
- Choice of LED Types and Colours

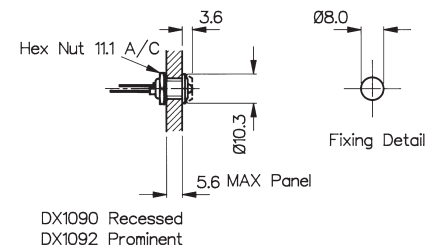

Aluminium Bezel - IP66 Sealed



DX1091

DX1093

- Aluminium Bezel, Clear
- Anodised Finish
- IP66 Front Panel Sealed
- Prominent or Recessed Style
- Choice of LED Types and Colours

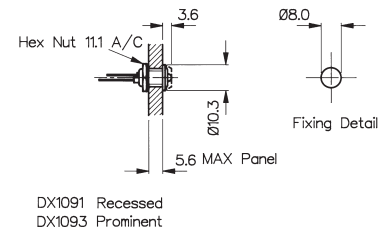

Specifications	DX1090, DX1092/Colour/Options	DX1091, DX1093/Colour/Options
Materials:	Aluminium - Black	Aluminium - Clear
Style:	Recessed (DX1090) Prominent (DX1092)	Recessed (DX1091) Prominent (DX1093)
Operating Temp. Range:	Dependent on LED used	Dependent on LED used
Storage Temperature:	Dependent on LED used	Dependent on LED used
Sealing (Front of panel):	Protection Classification IP66 to EN60529:1992+A2:2013	Protection Classification IP66 to EN60529:1992+A2:2013
Tightening Torque:	0.056Nm (8ozf.in.) min	0.056Nm (8ozf.in.) min
Lead Solder Time:	260°C for 5 seconds max.	260°C for 5 seconds max.
LED Colours:	/RD (Red), /GN (Green), /YL (Yellow), /BL (Blue), /TR (Tri Colour), /D1 (Dual Colour - Red/Green), /D2 (Dual Colour - Red/Amber), /D3 (Dual Colour - Green/Amber)	/RD (Red), /GN (Green), /YL (Yellow), /BL (Blue), /TR (Tri Colour), /D1 (Dual Colour - Red/Green), /D2 (Dual Colour - Red/Amber), /D3 (Dual Colour - Green/Amber)
Thread Size:	0.312" x 32TPI	0.312" x 32TPI
<b>RoHS</b>	Compliant	Compliant

See Page 212 for LED options and specifications



Chrome Plated Brass Bezel



DX1116

DX1118

- Chrome Plated Brass Bezel
- Prominent or Recessed Style
- Choice of LED Types and Colours

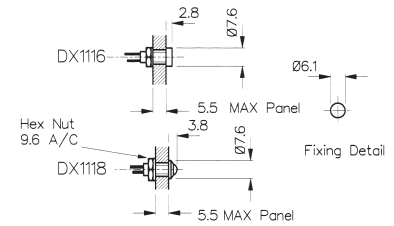

Black Nickel Pated Brass Bezel



DX1117

DX1119

- Aluminium, Black Anodised Bezel
- Prominent or Recessed Style
- Choice of LED Types and Colours

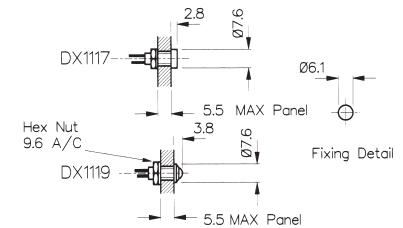

Specifications	DX1116, DX1118/Colour	DX1117, DX1119/Colour
Bezel Materials:	Brass, Chrome Plated	Aluminium, Black Anodised
Style:	Recessed (DX1116) Prominent (DX1118)	Recessed (DX1117) Prominent (DX1119)
Operating Temp. Range:	Dependent on LED used	Dependent on LED used
Storage Temperature:	Dependent on LED used	Dependent on LED used
Lead Solder Time:	260°C for 5 seconds max.	260°C for 5 seconds max.
LED Colours:	/RD (Red), /GN (Green), /YL (Yellow), /BL (Blue)	/RD (Red), /GN (Green), /YL (Yellow), /BL (Blue)
<b>RoHS</b>	Compliant	Compliant

See Page 213 for LED specifications\*

**5mm LEDs STANDARD**

Specification	Red	Green	Yellow	Blue
Luminous Intensity @20mA:	25mcd	20mcd	20mcd	21mcd
Forward voltage:	2.0V	2.0V	2.1V	3.5V
Cont. Forward Current (max):	30mA	25mA	30mA	30mA
Power Dissipation:	105mW (max) @20°C Ambient			120mW
Reverse Current:	10µA	10µA	10µA	50µA
Reverse Voltage:	5V (max)	5V (max)	5V (max)	5V (max)
Operating Temp:	-40°C to +85°C			-20°C to +80°C
Part No:	/RD	/GN	/YL	/BL

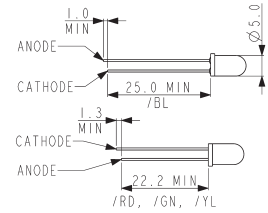

**5mm LEDs FLASHING**

Specification	Red	Green
Luminous Intensity @20mA:	1.2mcd	20mcd
Forward voltage:	2.0-15.0V	2.0V
Cont. Forward Current (max):	10-30mA	25mA
Power Dissipation:	200mW (max) @ 20°C ambient	
Flash Frequency @ 3V supply:	2.2Hz (typ)	
Operating Temp:	0°C to +70°C	
Part No:	/RD/02	/GN/02

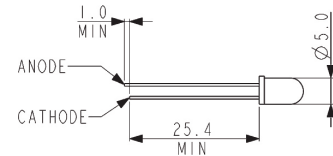

**5mm LEDs TRI COLOUR**

Specification	Red/Green/Amber
Luminous Intensity @20mA:	2.5mcd
Forward voltage:	2.4V
Cont. Forward Current (max):	30mA (max)
Power Dissipation:	150mW (max) @ 20°C Ambient
Reverse Current:	100µA
Reverse Voltage:	5V (max)
Operating Temp:	-40°C to +70°C
Part No:	/TR

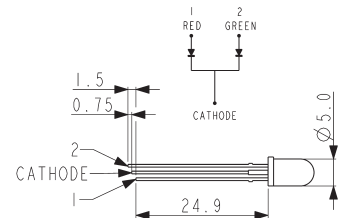

**5mm LEDs DUAL COLOUR**

Specifications	Red/Green	Red/Amber	Green/Amber
Luminous Intensity:	4.5/5mcd	4.5/4mcd	4/5mcd
Forward voltage:	2.2V	2.2V	2.2V
Cont. Forward Current:	30mA/30mA	30mA/20mA	30mA/20mA
Power Dissipation:	100mW/100mW	100mW/60mW	100mW/60mW
Reverse Current:	100mA	100mA	100mA
Reverse Voltage:	5V (max)	5V (max)	5V (max)
Operating Temp:	-40°C to +85°C		
Part No:	/D1	/D2	/D3

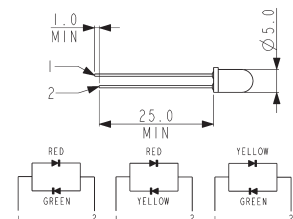

**4mm LEDs Standard**

Specifications	Red	Green	Yellow	Blue
Luminous Intensity @10mA:	2.5mcd	2.5mcd	2.5mcd	50mcd
Forward voltage:	2.0V	2.1V	2.0V	3.8V
Cont. Forward Current (max):	30mA	30mA	20mA	30mA
Power Dissipation (max) @ 20°C Ambient:	100mW	100mW	85mW	120mW
Reverse Current:	10µA	10µA	10µA	50µA
Reverse Voltage:	5V (max)	5V (max)	5V (max)	5V (max)
Part No:	/RD	/GN	/YL	/BL

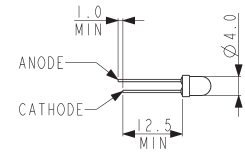

**Part No Breakdown**

DXxxxx	/	XX	/	XX
<b>Bezel Type</b>		<b>LED Colour</b> RD = Red GN = Green YL = Yellow BL = Blue D1 = Dual Colour - 5mm (Red/Green) D2 = Dual Colour - 5mm (Red/Amber) D3 = Dual Colour - 5mm (Green/Amber) TR = Tri Colour - 5mm (Red/Green/Amber)		<b>LED Options</b> Blank = Standard 02 = Flashing - 5mm (Red or Green only)

**Example:**  
DX1092/RD/02 = Black Aluminum IP66 Prominent Bezel, with Red flashing LED

# Indicator Lights

Neon, LED and Filament Lamp



## Key Features

- Neon, LED, mains LED or filament lamp
- Bezel sizes from 6.7 to 16.3mm diameter
- Red, amber, green, blue and clear lenses
- Red, yellow, green, blue and white LEDs
- Wide choice of styles

## Colours and voltages:



Available with Red, Amber, Green or Clear lenses  
100/130V (marked 110V),  
200/250V (marked 230V)



Red, Yellow, Green, Blue, White  
2.0/2.2V  
Resistors for other voltages available.



Red, Yellow, Green, Blue, White  
110-230V ac operation.



Available with Red, Amber, Green, Clear or Blue lenses  
6V, 12/14V, 24/28V.

Terminal	Type	Sealed	Illumination	Colour	Voltage	Options
<b>B</b> 2.8 <b>L</b>	<b>(B) 0566 A</b> 	6.0 2.0 max page 6	<b>N</b> <b>L</b> <b>M</b>	Neon & Filament <b>R</b> Red <b>A</b> Amber <b>G</b> Green <b>B</b> Blue (Special Order) <b>C</b> Clear	<b>1</b> LED No Resistor <b>2</b> 125V Neon <b>3</b> 250V Neon <b>4</b> 6Vdc LED <b>5</b> 12Vdc LED	<b>C</b> Chrome Bezel Finish
<b>B</b> 2.8 <b>L</b>	<b>(B) 0566 B</b> 	6.0 2.0 max page 6	<b>N</b> <b>L</b> <b>M</b>	Blue (Special Order) <b>C</b> Clear	<b>6</b> 24Vdc LED <b>7</b> 12/14V Filament	
<b>B</b> 2.8 <b>L</b>	<b>(B) 0566 C</b> 	6.0 2.0max page 6	<b>N</b> <b>L</b> <b>M</b>	Red <b>Y</b> Yellow <b>G</b> Green <b>B</b> Blue	<b>8</b> 24/ 28V Filament <b>9</b> 125/250Vac LED	
<b>C</b> 6.3	<b>(C) 0145 AA</b> 	5.8 3.0max page 6	<b>N</b> <b>L</b> <b>M</b> <b>F</b>	Green		
<b>L</b> <b>W</b>	<b>(L) 1041 00</b> 	6.3 6.3max page 6	<b>N</b> <b>L</b> <b>F</b>	Red		
<b>L</b> <b>W</b>	<b>(L) 1045 00</b> 	6.3 10.0max page 6	<b>N</b> <b>L</b> <b>M</b> <b>F</b>	Blue		

# Indicator Lights

Neon, LED and Filament Lamp



Terminal	Type	Sealed	Illumination	Colour	Voltage	Options
L W	(L) 0245 00 	7.1 6.3 max page 6	N L M F	Neon & Filament <b>R</b> Red <b>A</b> Amber <b>G</b> Green <b>B</b> Blue (Special Order) <b>C</b> Clear	<b>1</b> LED No Resistor <b>2</b> 125V Neon	<b>C</b> Chrome Bezel Finish
L	L 2950 00 	8.0 0.8-1.6 page 6	N L M F		<b>3</b> 250V Neon <b>4</b> 6Vdc LED	
L C 6.3	(L) 0195 BB 	8.0 0.8-3.0 page 6	N F		<b>5</b> 12Vdc LED	
L	L 2951 00 	8.0 0.8-1.6 page 6	N L M F	LED <b>R</b> Red <b>Y</b> Yellow <b>G</b> Green <b>B</b> Blue	<b>6</b> 24Vdc LED <b>7</b> 12/14V Filament <b>8</b> 24/ 28V Filament <b>9</b> 125/250Vac LED	
L H 4.8	H) 0568 A(*) 	8.0 0.8-3.5 page 6	N L F			
L H 4.8	(H) 0568 B(*) 	8.0 0.8-3.5 page 6	N L F			

## Dimensions

(B) 0566 A

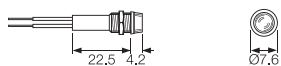

(B) 0566 B

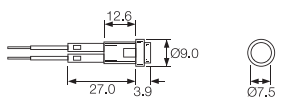

(B) 0566 C

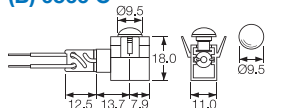

(C) 0145 AA

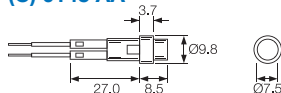

(L) 1041 00

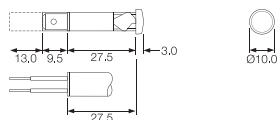

(L) 1045 00

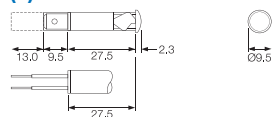

(L) 0245 00

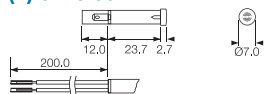

L 2950 00

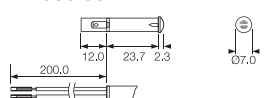

(L) 0195 BB

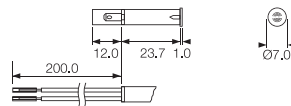

H) 0568 A(\*)

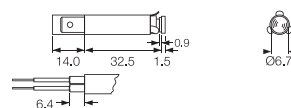

L 2951 00

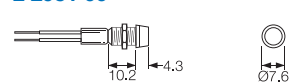

(H) 0568 B(\*)

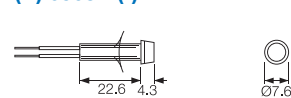

# Indicator Lights

Neon, LED and Filament Lamp



## Key Features

- ⊞ Neon, LED, mains LED or filament lamp
- ⊞ Bezel sizes from 6.7 to 16.3mm diameter
- ⊞ Red, amber, green, blue and clear lenses
- ⊞ Red, yellow, green, blue and white LEDs
- ⊞ Wide choice of styles

## Colours and voltages:

NEON	DC LED	AC MAINS LED	FILAMENT
Available with Red, Amber, Green or Clear lenses 100/130V (marked 110V), 200/250V (marked 230V)	Red, Yellow, Green, Blue, White 2.0/2.2V Resistors for other voltages available.	Red, Yellow, Green, Blue, White 110-230V ac operation.	Available with Red, Amber, Green, Clear or Blue lenses 6V, 12/14V, 24/28V.

Terminal	Type	Illumination	Colour	Voltage	Options	Panel	Approval
L	<b>(L) 0569 AW</b> 	N L M F	Neon & Filament  <b>R</b> Red  <b>A</b> Amber  <b>G</b> Green  <b>B</b> Blue (Special Order)  <b>C</b> Clear	<b>1</b> LED No Resistor  <b>2</b> 125V Neon	<b>C</b> Chrome Bezel Finish	9.0 0.8-2.5 Call sales	
L K 2.8 H 4.8 C 6.3	<b>(C) 0273 00</b> 	N L M F	<b>B</b> Blue (Special Order)  <b>C</b> Clear	<b>3</b> 250V Neon		9.0 2.0 max page 6	
L K 2.8 H 4.8 C 6.3	<b>(C) 0278 00</b> 	N L M F	<b>B</b> Blue (Special Order)  <b>C</b> Clear	<b>4</b> 6Vdc LED		9.0 2.0 max page 6	
L K 2.8 H 4.8 C 6.3	<b>(C) 0276 AA</b> 	N L M F	<b>R</b> Red	<b>6</b> 24Vdc LED		9.5 0.8-2.8 page 6	
L K 2.8 H 4.8 C 6.3	<b>(C) 0275 00</b> 	N L M F	<b>R</b> Red  <b>Y</b> Yellow	<b>7</b> 12/14V Filament  <b>8</b> 24/ 28V Filament		10.0 12.0 page 6	
L K 2.8 H 4.8 C 6.3	<b>(C) 0275 00</b> 	N L M F	<b>G</b> Green  <b>B</b> Blue	<b>9</b> 125/250Vac LED		10.0 11.5 max page 6	

# Indicator Lights

Neon, LED and Filament Lamp



Terminal	Type	Illumination	Colour	Voltage	Options	Panel	Approval
<b>L</b> <b>K</b> 2.8 <b>H</b> 4.8 <b>C</b> 6.3	<b>(C) 0276 00</b> 	<b>N</b> <b>L</b> <b>M</b> <b>F</b>	Neon & Filament	<b>1</b> LED No Resistor	<b>C</b> Chrome Bezel Finish	 10.0 2.8 max page 6	
			<b>R</b> Red	<b>2</b> 125V Neon			
			<b>A</b> Amber	<b>3</b> 250V Neon			
			<b>G</b> Green	<b>4</b> 6Vdc LED			
			<b>B</b> Blue (Special Order)	<b>5</b> 12Vdc LED			
<b>L</b> <b>K</b> 2.8 <b>H</b> 4.8 <b>C</b> 6.3	<b>(C) 0277 00</b> 	<b>N</b> <b>L</b> <b>M</b> <b>F</b>	<b>C</b> Clear	<b>6</b> 24Vdc LED	 10.0 12 max page 6		
			<b>R</b> Red	<b>7</b> 12/14V Filament			
			<b>Y</b> Yellow	<b>8</b> 24/ 28V Filament			
			<b>G</b> Green	<b>9</b> 125/250Vac LED			
			<b>B</b> Blue				
<b>L</b> <b>K</b> 2.8 <b>H</b> 4.8 <b>C</b> 6.3	<b>(C) 0273 LL</b> 	<b>N</b> <b>L</b> <b>M</b> <b>F</b>			 10.0 0.6-2.0 page 6		
<b>L</b> <b>K</b> 2.8 <b>H</b> 4.8 <b>C</b> 6.3	<b>(C) 2820 00</b> 	<b>N</b> <b>L</b> <b>M</b> <b>F</b>			 12.0 0.75-2.0 page 6		
<b>L</b> <b>K</b> 2.8 <b>H</b> 4.8 <b>C</b> 6.3	<b>(C) 2821 00</b> 	<b>N</b> <b>L</b> <b>M</b> <b>F</b>			 12.0or12.7 ø12.0 = 0.8-2.5 ø12.7 = 1.1-2.5 page 6		
<b>L</b> <b>K</b> 2.8 <b>H</b> 4.8 <b>C</b> 6.3	<b>(C) 0586 00</b> 	<b>N</b> <b>L</b> <b>M</b> <b>F</b>			 12.5 0.8-1.5 page 6		

## Dimensions

### (L) 0569 AW

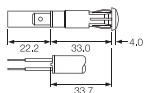

### (C) 0275 00

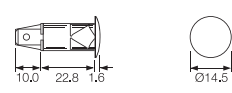

### (C) 0273 LL

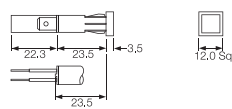

### (C) 0273 00

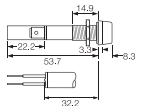

### (C) 0275 00

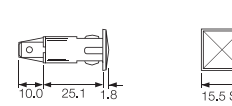

### (C) 2820 00

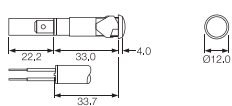

### (C) 0278 00

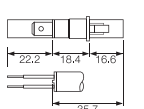

### (C) 0276 00

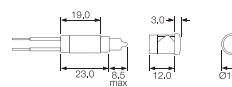

### (C) 2821 00

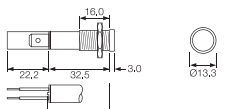

### (C) 0276 AA

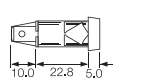

### (C) 0277 00

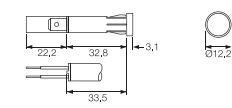

### (C) 0586 00

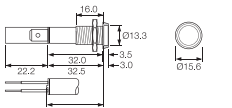

# Indicator Lights

Neon, LED and Filament Lamp



## Key Features

- Neon, LED, mains LED or filament lamp
- Bezel sizes from 6.7 to 16.3mm diameter
- Red, amber, green and clear lenses
- Red, yellow, green, blue and white LEDs
- Wide choice of styles

## Colours and voltages:

<b>NEON</b>	<b>DC LED</b>	<b>AC MAINS LED</b>	<b>FILAMENT</b>
Available with Red, Amber, Green or Clear lenses 100/130V (marked 110V), 200/250V (marked 230V)	Red, Yellow, Green, Blue, White 2.0/2.2V Resistors for other voltages available.	Red, Yellow, Green, Blue, White 110-230V ac operation.	Available with Red, Amber, Green, Clear or Blue lenses 6V, 12/14V, 24/28V.



















Terminal	Type	Illumination	Colour	Voltage	Options	Panel	Approval
<b>L</b> <b>K</b> 2.8 <b>H</b> 4.8 <b>C</b> 6.3	<b>(C) 2870 00</b> 	<b>N</b> <b>L</b> <b>M</b> <b>F</b>	Neon & Filament	<b>1</b> LED No Resistor	<b>C</b> Chrome Bezel Finish	12.7	    
			<b>R</b> Red	<b>2</b> 125V Neon		0.75-2.0	
			<b>A</b> Amber	<b>3</b> 250V Neon		Page 6	
			<b>G</b> Green	<b>4</b> 6Vdc LED		12.7	
<b>L</b> <b>K</b> 2.8 <b>H</b> 4.8 <b>C</b> 6.3	<b>C) 0589 00</b> 	<b>N</b> <b>L</b> <b>M</b> <b>F</b>	<b>B</b> Blue (Special Order)	<b>5</b> 12Vdc LED	<b>C</b> Chrome Bezel Finish	0.8-1.5	    
			<b>C</b> Clear	<b>6</b> 24Vdc LED		page 6	
			<b>L</b> LED	<b>7</b> 12/14V Filament		12.7	
			<b>R</b> Red	<b>8</b> 24/ 28V Filament		12.0max	
<b>L</b> <b>K</b> 2.8 <b>H</b> 4.8 <b>C</b> 6.3	<b>L 0081 00</b> 	<b>N</b> <b>L</b> <b>M</b> <b>F</b>	<b>Y</b> Yellow	<b>9</b> 125/250Vac LED	<b>C</b> Chrome Bezel Finish	9.5	    
			<b>G</b> Green	<b>1</b> LED No Resistor		page 6	
			<b>A</b> Amber	<b>2</b> 125V Neon		12.7	
			<b>B</b> Blue (Special Order)	<b>3</b> 250V Neon		12.0max	
<b>L</b> <b>K</b> 2.8 <b>H</b> 4.8 <b>C</b> 6.3	<b>(C) 0177 00</b> 	<b>N</b> <b>L</b> <b>M</b> <b>F</b>	<b>C</b> Clear	<b>4</b> 6Vdc LED	<b>C</b> Chrome Bezel Finish	page 6	    
			<b>L</b> LED	<b>5</b> 12Vdc LED		12.7	
			<b>R</b> Red	<b>6</b> 24Vdc LED		12.0max	
			<b>G</b> Green	<b>7</b> 12/14V Filament		page 6	
<b>L</b> <b>K</b> 2.8 <b>H</b> 4.8 <b>C</b> 6.3	<b>(C) 0067 00</b> 	<b>N</b> <b>L</b> <b>M</b> <b>F</b>	<b>Y</b> Yellow	<b>8</b> 24/ 28V Filament	<b>C</b> Chrome Bezel Finish	1.14 max	    
			<b>G</b> Green	<b>9</b> 125/250Vac LED		page 6	
			<b>A</b> Amber	<b>1</b> LED No Resistor		12.7	
			<b>B</b> Blue (Special Order)	<b>2</b> 125V Neon		19.0 max	
<b>L</b> <b>K</b> 2.8 <b>H</b> 4.8 <b>C</b> 6.3	<b>(C) 0180AA</b> 	<b>N</b> <b>L</b> <b>M</b> <b>F</b>	<b>B</b> Blue	<b>3</b> 250V Neon	<b>C</b> Chrome Bezel Finish	page 6	    
			<b>L</b> LED	<b>4</b> 6Vdc LED		12.7	
			<b>R</b> Red	<b>5</b> 12Vdc LED		12.0max	
			<b>G</b> Green	<b>6</b> 24Vdc LED		page 6	



# Indicator Lights

Neon, LED and Filament Lamp



Terminal	Type	Illumination	Colour	Voltage	Options	Panel	Approval
L C 6.3	(C) 0180BB 	N  L  F 	Neon & Filament  <b>R</b> Red  <b>A</b> Amber  <b>G</b> Green  <b>B</b> Blue (Special Order)  <b>C</b> Clear  LED  <b>R</b> Red  <b>Y</b> Yellow  <b>G</b> Green  <b>B</b> Blue	<b>1</b> LED No Resistor  <b>2</b> 125V Neon  <b>3</b> 250V Neon  <b>4</b> 6Vdc LED  <b>5</b> 12Vdc LED  <b>6</b> 24Vdc LED  <b>7</b> 12/14V Filament  <b>8</b> 24/ 28V Filament  <b>9</b> 125/250Vac LED	<b>C</b> Chrome Bezel Finish	 13.5  0.9-1.14  page 6   14.0  2.5 max  page 6   19.0  4.0max  page 6	     

## Dimensions

(C) 2870 00

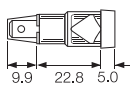

(C) 0067 00

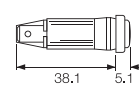

(C) 1092

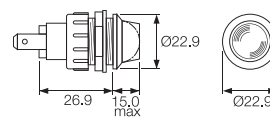

(C) 0589 00

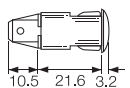

(C) 0180AA

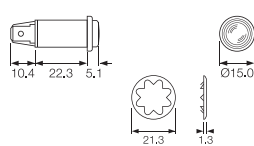

L 0081 00

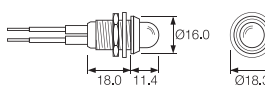

(C) 0180BB

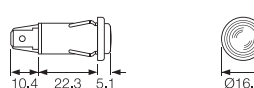

(C) 0177 00

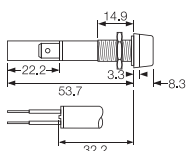

(C) 0579 00

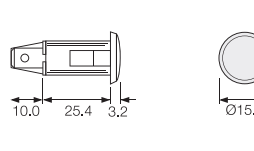

# Indicator Lights

Neon, LED and Filament Lamp



## Key Features

- Neon, LED, mains LED or filament lamp
- Bezel sizes from 6.7 to 16.3mm diameter
- Red, amber, green and clear lenses
- Red, yellow, green, blue and white LEDs
- Wide choice of styles

## Colours and voltages:

<b>NEON</b>  Available with Red, Amber, Green or Clear lenses 100/130V (marked 110V), 200/250V (marked 230V)	<b>DC LED</b>  Red, Yellow, Green, Blue, White 2.0/2.2V Resistors for other voltages available.	<b>AC MAINS LED</b>  Red, Yellow, Green, Blue, White 110-230V ac operation.	<b>FILAMENT</b>  Available with Red, Amber, Green, Clear or Blue lenses 6V, 12/14V, 24/28V.
--	---	--	--

Terminal	Type	Illumination	Colour	Voltage	Options	Panel	Approval				
H 4.8	<b>H 0581 AY</b> 	N F	Neon & Filament	<b>1</b> LED No Resistor	<b>C</b> Chrome Bezel Finish	 18.2/18.3 x 6.2/6.3 2.0-3.5 Page 6					
			<b>R</b> Red	<b>2</b> 125V Neon							
			<b>A</b> Amber	<b>3</b> 250V Neon							
			<b>G</b> Green	<b>4</b> 6Vdc LED							
			<b>B</b> Blue (Special Order)	<b>5</b> 12Vdc LED							
			<b>C</b> Clear	<b>6</b> 24Vdc LED							
			<b>R</b> Red	<b>7</b> 12/14V Filament							
			<b>Y</b> Yellow	<b>8</b> 24/ 28V Filament							
			<b>G</b> Green	<b>9</b> 125/250Vac LED							
L	<b>L 0234 00</b> 	N	<b>G</b> Green	<b>3</b> 250V Neon	 9.27/9.50 x 4.75 0.71-1.62 page 6						
			<b>B</b> Blue (Special Order)	<b>4</b> 6Vdc LED							
			<b>C</b> Clear	<b>5</b> 12Vdc LED							
			<b>R</b> Red	<b>6</b> 24Vdc LED							
			<b>Y</b> Yellow	<b>7</b> 12/14V Filament							
			<b>G</b> Green	<b>8</b> 24/ 28V Filament							
			<b>B</b> Blue	<b>9</b> 125/250Vac LED							
			L	<b>L 0233 00</b> 			N	<b>C</b> Clear	<b>5</b> 12Vdc LED	 9.27/9.50 x 4.75 0.71-1.62 page 6	
								<b>R</b> Red	<b>6</b> 24Vdc LED		
<b>Y</b> Yellow	<b>7</b> 12/14V Filament										

## Dimensions

### H 0581 AY

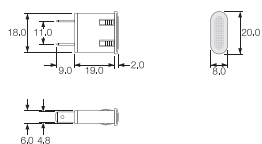

### L 0234 00

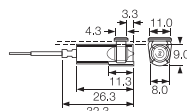

### L 0233 00

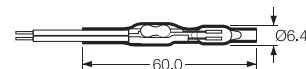





Neon tube, resistor and flexible lead assembly, protected by "shrunk on" transparent sleeving.

## Key Features

- ⬡ Up to 50V
- ⬡ Red, Amber, Green, Blue and Clear
- ⬡ Linestra/Philinea lamp holder

## Colours and voltages:

These lampholders are suitable for up to 50V max. Bulbs will be supplied (dependent on order quantity) if a voltage is specified.  
Colours - Red, Amber, Green, (Clear & Blue, check availability).

Terminal	Type	Sealed	Illumination	Colour	Voltage	Options	Panel
T	<b>T0061 00 (LES)</b> 	<b>S</b> Sealed	<b>N</b> Neon	Neon & Filament <b>R</b> Red	<b>1</b> LED No Resistor	<b>C</b> Chrome Bezel Finish	9.5 0.9-1.14 T85
C	<b>(C) 0277 00</b> 		<b>L</b> DC LED	Amber <b>A</b>	<b>2</b> 125V Neon		12.7 1.14max T85
T 6.3	<b>(C) 0273 LL</b> 		<b>M</b> Mains AC LED	Green <b>G</b>	<b>3</b> 250V Neon		12.7 9.6max T85
T	<b>(C) 2820 00</b> 		<b>F</b> Mains AC LED	Blue (Special Order) <b>B</b>	<b>4</b> 6Vdc LED		12.7 9.6max T85
S	<b>(C) 2821 00</b> 			Clear <b>C</b>	<b>5</b> 12Vdc LED		12.7 9.6max T85
				LED <b>R</b> Red	<b>6</b> 24Vdc LED		12.7 9.6max T85
				Yellow <b>Y</b>	<b>7</b> 12/14V Filament		
				Green <b>G</b>	<b>8</b> 24/ 28V Filament		
				Blue <b>B</b>	<b>9</b> 125/250Vac LED		T85

**T0061 00 (LES)**

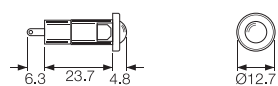

**(C) 2820 00**



**(C) 0273 LL**

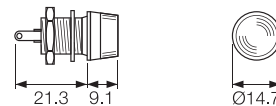

**(C) 0277 00**

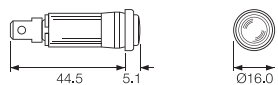

**(C) 2821 00**

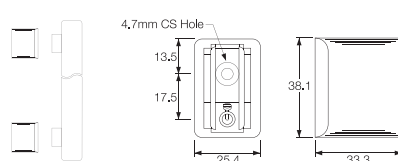



C1090FE ---



P1090FL ---

## Key Features

- Up to 50V
- MES or MBC bulb
- Flat and domed lens
- Brass or nylon bodies
- Red, Amber, Green, Blue and Clear lenses

## Approvals and specifications

Bulbs will be supplied (dependant on order quantity) if a voltage is specified. These lampholders are suitable for up to 50V max.





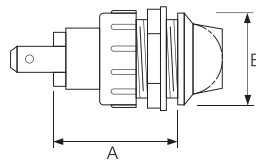

Colours - Red, Amber, Green, (Clear & Blue, check availability).  
Brass bodies have polished chrome finish.

## Dimensions and Options

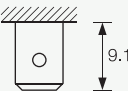

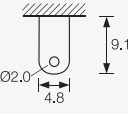
F0445 MO  
P.V.C. Insulating terminal cover.

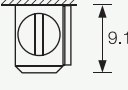

Terminal	Type	Colour	Bulb Voltage	Options	Panel	Lens		
<b>C</b>  6.3 x 0.8	<b>1090</b> MES (E10)	<b>R</b> Red	<b>6</b> 6V	<b>C</b> Chrome Bezel Finish	<b>1090 (MES lamps)</b>	<b>F</b> Flat 		
		<b>Y</b> Yellow	<b>12</b> 12V				<b>Dim A</b> 35.0	<b>Dim B</b> 22.0
		<b>G</b> Green	<b>24</b> 24V				<b>Dim A</b> 30.2	<b>Dim B</b> 22.0
		<b>B</b> Blue	Max of 50V				<b>Dim A</b> 30.2	<b>Dim B</b> 22.8
		<b>C</b> Clear					<b>Dim A</b> 24.6	<b>Dim B</b> 22.0
<b>T</b>  Solder	<b>1091</b> MBC (BA9s) (C and S Terminals only)				<b>1091 (MBC lamps)</b>	<b>V</b> MES (E10) 		
				<b>Dim A</b> 24.6			<b>Dim B</b> 22.8	
				<b>Dim A</b> 24.6			<b>Dim B</b> 22.8	
				<b>Dim A</b> 26.0			<b>Dim B</b> 31.5	
<b>S</b>  Screw and Clamp					<b>L</b> No lens 			
				<b>Dim A</b> 36.0		<b>Dim B</b> 22.0		
				<b>Dim A</b> 36.6		<b>Dim B</b> 22.0		
				<b>Dim A</b> 36.6		<b>Dim B</b> 22.8		
				<b>Dim A</b> 38.1		<b>Dim B</b> 31.5		

# LED Lamps and LED Lampholders

LED Lampholders can be supplied with or without LEDs



## Key Features

- LED lampholders
- Supplied with or without LEDs
- Black or Chrome finish

## Colours and voltages:

Colours: Red, Yellow, Green and Blue LEDs  
(High Intensity is standard. Option of extra super bright).

Voltages: LEDs are available for direct connection to 2.0/2.2V or 12Vdc

For other voltages contact sales.

Terminal	Type	Body Colour	LED Colour	Voltage	Panel Cutout	Approval	Dimensions
<b>W</b> LED fitted <b>A</b> LED not fitted <b>L</b> LED & Wires fitted	<b>(W) 1048 00</b> 	<b>B</b> Black  — Blank	<b>R</b> Red  <b>Y</b> Red  <b>G</b> Green	<b>1</b> LED No Resistor  <b>4</b> 6Vdc LED  <b>5</b> 12Vdc LED	 6.3  6.3max  T105		 12.7 14.5 (+/-0.36) 1.5 Ø7.6
<b>W</b> LED fitted <b>A</b> LED not fitted <b>L</b> LED & Wires fitted	<b>(L) 1048 0A</b> 		<b>B</b> Blue	<b>6</b> 24Vdc LED	 8.0  5.5max  T105		 10.0 14.5 2.0 Ø9.5
<b>W</b> LED fitted <b>A</b> LED not fitted <b>L</b> LED & Wires fitted	<b>(W) 1050 0A</b> 				 8.0  7.0max  T105	 	 12.4 16.9 2.9 Ø10.0
<b>W</b> LED fitted <b>L</b> LED & Wires fitted	<b>(L) 1035 0A</b> 				 4.5  0.9-1.6  T105	 	 4.30 20.0 1.0 200.0 1.50 5.08
<b>W</b> LED fitted <b>L</b> LED & Wires fitted	<b>(L) 1036 0A</b> 				 6.0  0.9-1.6  T105	 	 5.85 20.0 1.0 200.0 4.0 7.9
<b>W</b> LED fitted <b>L</b> LED & Wires fitted	<b>(L) 1037 0A</b> 				 6.35  0.9-1.6  T105	 	 6.15 20.0 1.0 200.0 4.0 7.9

# LED Lamps and LED Lampholders - Sealed to IP67





















## Key Features

- ⊞ IP67 front bezel sealing
- ⊞ LED lampholders
- ⊞ Supplied with or without LEDs
- ⊞ Black or Chrome finish

## Colours and voltages:

Colours:  
Red, Yellow Green and Blue LEDs.  
(High Intensity is standard. Option of extra super bright).

Voltages:  
LEDs are available for direct connection to 2.0/2.2V or 12Vdc.  
For other voltages contact sales.

Terminal	Type	LED Colour	Voltage	Panel	Approval
<b>L</b> LED & Wires fitted 	<b>(L) 1048 00</b> 	<b>B</b> Blue	<b>6</b> 24Vdc LED	 8.0  5.5max  T105	
<b>W</b> LED fitted 	<b>(W) 1050 00</b> 			 8.0  7.0max  T105	
<b>A</b> LED not fitted 					
<b>L</b> LED & Wires fitted 	<b>(W) 1050 00</b> 			 8.0  7.0max  T105	

## Dimensions

### (L) 1048 00

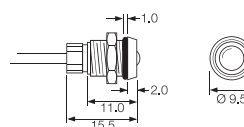

### (W) 1050 00

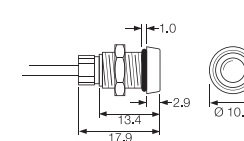

### (W) 1050 00

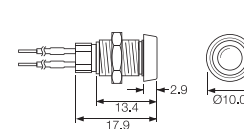

## Properties

### Sealing

O-ring sealing equivalent to IP67, of both the LED to bezel, and bezel to panel is available where shown.

### Polarity

The nylon base mouldings are polarity marked.

### Body Material and Finish

Chromed brass or Black oxide coated brass.

### Lampholders only

Items prefixed 'A' are supplied without LEDs.

### LED wires or PVC covered wire leads

125mm min length wires, 6.3mm standard strip.  
Alternative colours, length and strip available.

# Indicator Lights - Sealed to IP67



## Key Features

- IP67 Panel Sealing
- Supplied complete with gaskets/'O' rings
- Neon, LED, mains LED or filament lamp
- Bezel sizes from 7.6 to 22.9mm diameter
- Red, amber, green, blue and clear lenses
- Red, yellow, green, blue and white LEDs
- Wide choice of styles

## Colours and voltages:

<b>NEON</b>  Available with Red, Amber, Green or Clear lenses 100/130V (marked 110V), 200/250V (marked 230V)	<b>DC LED</b>  Red, Yellow, Green, Blue, White 2.0/2.2V Resistors for other voltages available.	<b>AC MAINS LED</b>  Red, Yellow, Green, Blue, White 110-230V ac operation.	<b>FILAMENT</b>  Available with Red, Amber, Green, Clear or Blue lenses 6V, 12/14V, 24/28V.
--	---	--	--

Terminal	Type	Sealed	Illumination	Colour	Voltage	Option	Panel Cutout	Approval
L	<b>(L) 1041 OS</b> 	<b>S</b> Sealed	N L M F	<b>R</b> Red <b>A</b> Amber	<b>1</b> LED No Resistor <b>2</b> 125V Neon	<b>C</b> Chrome Bezel Finish	6.3 5.3max	
L	<b>(L) 0245 OS</b> 		N L M F	<b>G</b> Green <b>B</b> Blue (Special)	<b>3</b> 250V Neon		7.1 4.6max	
L C 6.3 K 2.8 H 4.8	<b>(C) 0275 OS</b> 		N L M F	<b>C</b> Clear	<b>4</b> 6Vdc LED <b>5</b> 12Vdc LED		10.0 11.15max	
L C 6.3 K 2.8 H 4.8	<b>(C) 0277 OS</b> 		N L M F	LED <b>R</b> Red	<b>6</b> 24Vdc LED		10.0 11.15max	
L C 6.3 K 2.8 H 4.8	<b>(C) 0177 OS</b> 		N L M F	<b>Y</b> Yellow <b>G</b> Green	<b>7</b> 12/14V Filament <b>8</b> 24/ 28V Filament		12.7 11.15max	
L C 6.3	<b>(C) 1092 FFS</b> 		N	<b>B</b> Blue <b>W</b> White	<b>9</b> 125/250Vac LED		19.0 4.0 max	

**(L) 1041 OS**

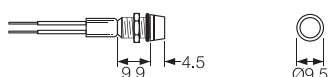

**(L) 0245 OS**

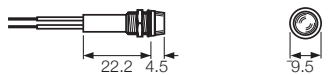

**(C) 0275 OS**

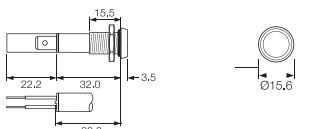

**(C) 0277 OS**

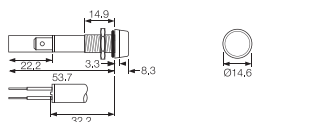

**(C) 0177 OS**

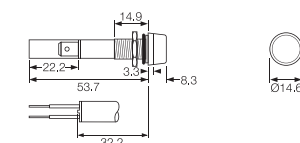

**(C) 1092 FFS**

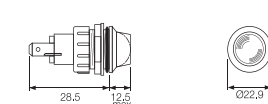

# Low Voltage Lamp Holders - Sealed to IP67



## Key Features

- ⊖ IP67 Panel Sealing
- ⊖ Supplied complete with gaskets/'O' rings
- ⊖ Neon, LED, mains LED or filament lamp
- ⊖ Bezel sizes from 7.6 to 22.9mm diameter
- ⊖ Red, amber, green, blue and clear lenses
- ⊖ Red, yellow, green, blue and white LEDs

## Colours and voltages:

These lampholders are suitable for up to 50V max. Bulbs will be supplied (dependent on order quantity) if a voltage is specified. Colours - Red, Amber, Green, (Clear & Blue, check availability).

Terminal	Type	Sealed	Colour	Bulb Voltage	Options	Panel	Approvals	Dimensions
C 6.3	<b>C1090 FPS (MES)</b> 	S Sealed	R Red	6 6V	C Chrome Bezel Finish	19.0 4.0max T85		 30,2 12,5 max
			A Amber	12 12V				
C 6.3	<b>C1091 FQS (MBC)</b> 		G Green	24 24V		7.1 4.6max		 35,0 12,5 max
			B Blue (Special)					
T	<b>T0062 AOS (Midget flange)</b> Chrome bezel <b>T0063 AOS (LES) Chrome bezel</b> 		C Clear			10.0 11.15max		 21,3 9,1  Ø14,7
T	<b>T0062 MOS (LES &amp; Midget flange)</b> <b>T0063 MOS (LES)</b> 					10.0 11.15max		 21,3 9,5  Ø14,7

**F0445 MO**  
P.V.C. Insulating terminal cover.  
For use with C1090 & C1091





## Terms and Conditions of Sale

All orders are accepted subject to our Standard Terms & Conditions. Copies of these are available:  
[www.elektron-technology.com/terms/](http://www.elektron-technology.com/terms/)

## Health & Safety

Bulgin proprietary components are designed, manufactured, assessed and tested to comply with good commercial quality and engineering standards. They are safe and reliable in use within the vast majority of normal environments. In the interest of safety, application in certain extreme destructive or unsuitable environments must be avoided. The following restrictions are given as guidance:

- External or wet areas (exposed to rain or spray), except where designated "Sealed".
- Atmospheres designated as "explosive", except where designated "Gas Tight" or "Explosion Proof".
- Highly corrosive atmospheres or subject to contamination by corrosive chemicals.  
(Avoid the use of corrosive acid soldering flux. Use an approved Electrical Grade).
- Atmospheres containing a high density of abrasive dust (mechanically operated components).
- Contamination with Silicone or Silicone Compounds (switches).
- Areas or levels unprotected from severe impact by heavy bodies moving in close proximity - (panel mounted components).
- Extremes of temperatures, beyond the specified limits.
- Electric supply voltage or load current above the published maximum ratings.

## General

To ensure electrical safety as far as is reasonably practical, these products should be properly applied, installed and maintained by or under the supervision of competent persons in accordance with good engineering practice.

## Dimensions

All dimensions are in millimetres (mm) unless otherwise stated.

## The CE Marking Directive

Equipment bearing the CE mark is allowed free circulation throughout Europe. The products in this catalogue, when installed correctly, comply with the CE requirements where it relates to them.

## The Low Voltage Directive

The Low Voltage Directive 2006/95/EC seeks to ensure that electrical equipment within certain limits both provides a high level of protection for European citizens and enjoys a single market in the European Union. Where applicable, Bulgin products comply with the requirements of this directive.

## RoHS

These European Directives introduced environmental responsibilities for electrical and electronics equipment manufacturers. The RoHS (Restriction of use of certain Hazardous Substances) regulation (Directive 2002/95/EC) came into force July 2006. The WEEE (Waste Electrical and Electronic Equipment) regulation (Directive 2002/96/EC), came into force January 2007. The RoHS directive effectively bans the use of certain chemicals, these are defined as:

- Lead
- Cadmium
- Mercury
- Hexavalent Chromium
- Polybrominated Biphenyl (PBB) – flame retardant
- Polybrominated Diphenyl Ether (PBDE) – flame retardant (including Deca BDE)

Action has been taken to ensure all standard products meet the requirements of this directive. All packing carries RoHS compliance information as conformation.

## REACH

REACH (Registration, Evaluation, Authorisation and Restriction of Chemicals) is the new system for controlling chemicals in Europe and became law in the UK on 1 June 2007. Elektron Technology as a manufacturer of articles, are reliant on our supply chain to ensure that the substances/articles we use, are in compliance with the EC1907/2006, REACH Regulations.

Our articles and their packaging, based on our knowledge at this point, do not contain any of the 15 substances on the SVHC Candidate List, dated 28th October 2008, nor any of the 14 substances added to the SVHC Candidate List, dated 13th January 2010, nor Acrylamide added to the SVHC Candidate List, dated 30th March 2010, according to article 59 (1, 10) of Regulation (EC) No. 1907/2006 (REACH), in a concentration above 0.1% weight by weight.

If this situation changes we confirm that this information will be passed through the supply chain in a timely manner.

# General Information



United Kingdom



B.S.I. Kitemark

Denmark



D.E.M.K.O.

South Africa



S.A. Bureau of Standards

BS EN ISO 9001:2000



B.S.I. British Electro-Technical Approvals Board

Europe



E.N.E.C.

Sweden



S.E.M.K.O.

Austria



O.V.E.

Finland



F.I.M.K.O.

Switzerland



S.E.V.

Australia



State Electricity Commission of Victoria



The Regulatory Compliance Mark (RCM)

Germany



S.E.V.

U.S.A.



U.L. Recognised



U.L. Listed

Belgium



CEBEC

Holland



KEMA-KEUR

Russia



GOST The State Committee for Standards

Canada



C.S.A.

Italy



I.M.Q.

China



C.C.C.

Norway



N.E.M.K.O.

# Comparison Chart

Metric to AWG wire sizes



AWG	Cross Sectional Area in mm <sup>2</sup>	Closest standard equivalent in mm <sup>2</sup>
30	0.0503	0.05
29	0.0646	-
28	0.0804	-
27	0.102	0.1
26	0.128	0.14
25	0.163	-
24	0.205	0.2
23	0.259	0.25
22	0.325	-
21	0.412	-
20	0.519	0.5
19	0.653	-
18	0.823	0.75
17	1.04	1
16	1.31	-
15	1.65	1.5
14	2.08	-
13	2.63	2.5
12	3.13	-
11	4.15	4
10	5.27	-
9	6.62	6
8	8.35	-
7	10.6	10
6	13.3	-
5	16.8	16
4	21.2	-
3	26.7	25
2	33.6	35
1	42.4	-
0	53.4	50
2/0	67.5	70
3/0	85	95
4/0	107.2	120
5/0	135.1	150
6/0	170.3	185

## IP Ratings Guide

The IP classification system designates the degree of protection provide by an enclosure against solid objects or water ingress. Table I shows degrees of protection against solid objects. Table II shows degrees of protection against water.



**Table 1 (1st characteristic numeral)**  
Degree of Protection against solid objects

**Table 2 (2nd characteristic numeral)**  
Degree of Protection against water

Digit	Description
0	Non-protected
1	Protected against a solid object greater than 50mm, such as a hand.
2	Protected against a solid object greater than 12.5mm, such as a finger.
3	Protected against a solid object greater than 2.5mm, such as wire or a tool.
4	Protected against a solid object greater than 1.0mm, such as wire or thin strips.
5	Dust-protected. Prevents ingress of dust sufficient to cause harm.
6	Dust tight. No ingress of dust.

Digit	Description
0	Non-protected
1	Protected against dripping water.
2	Protected against dripping water when tilted up to 15°.
3	Protected against spraying water at an angle of up to 60°.
4	Protected against splashing water from any direction.
5	Protected against jets of water from any direction.
6	Protected against heavy seas or powerful jets of water. Prevents ingress sufficient to cause harm.
7	Protected against the effects of temporary immersion in water.
8	Protected against the effects of continuous immersion in water.
69K	Protected against very high pressure, high temperature wash-down test.

Degree of protection to - DIN 40050-9

# Part No. Index

12023	25	BZV03/Z0000/07	274 - 275	FX0380	314
12023/1	25	BZV04/Z0000/04	276	FX0385	314
12023/2	25	BZV09/Z0000/04	278	FX0415	305
12734	32	BZV45/Z0000/02	279	FX0415/S	305
12734/1	32	BZV49/Z0000/69	277	FX0416	305
12734/3	32	DX0505	317	FX0416/S	305
12734/3/1	32	DX0506	317	FX0419	309
12735	32	DX0507	318	FX0430/63	302
12735/1	32	DX0508	318	FX0430/PC	302
12735/3	32	DX0998	319	FX0454	304
12735/3/1	32	DX0999	319	FX0454/S	304
13027	37, 43	DX1090	320	FX0455	304
13027/1	37, 43	DX1091	320 - 321	FX0455/S	304
13027/2	37, 43	DX1092	320	FX0456	311
14025	37, 43	DX1093	320 - 321	FX0458	304
14025/1AMP	37, 43	DX1116	321	FX0461	311
14025/5AMP	37, 43	DX1118	321	FX0462	309
14025/8AMP	37, 43	DX1120	319	FX0463	309
14150	66, 101	DX1121	319	KT0006	260
14151	66, 101	EXP-0911/02/P	11	KT0009	260
14191	73, 78, 96	EXP-0911/03/P	11	KT0012	260
14192	73, 78, 96	EXP-0911/04/P	11	MP0012/1/Col	164
14193	73, 96	EXP-0911/05/P	11	MP0012/Col	164
14194	73, 96	EXP-0911/07/P	11	MP0013	155
14199	66, 101	EXP-0911/10/P	11	MP0013/2	155
14563	78	EXP-0931/02/P	12	MP0016	164
14564	78	EXP-0931/03/P	12	MP0022/Col	165
BOX1M1205MA05	141	EXP-0931/04/P	12	MP0027	144
BOX1M1205MA09	141	EXP-0931/05/P	12	MP0027/2	153
BOX1M1212MA08	141	EXP-0931/07/P	12	MP0027/3	151
BVA01/Z0000/02	286	EXP-0931/10/P	12	MP0031	145
BVA01/Z0000/10	287 - 288	EXP-0941/02/P	12	MP0031/2	154
BVB01/Z0000/01	286	EXP-0941/04/P	12	MP0031/3	152
BVB01/Z0000/11	287	EXP-0941/05/P	12	MP0033	155
BX0001/1	233	EXP-0941/07/P	12	MP0033/2	155
BX0002/1	233	EXP-0941/10/P	12	MP0037	145
BX0003/1	233	EXP-0980	12	MP0037/2	154
BX0011/1	233	EXP-0990	12	MP0037/3	152
BX0012/1	233	EXP-0991	12	MP0038	144
BX0013/1	233	EXP-0992	12	MP0038/2	153
BX0023	234	EXP-A911/03/P	11	MP0038/3	151
BX0026	234	EXP-A911/04/P	11	MP0042/1	156
BX0027	233	EXP-A911/05/P	11	MP0042/2	156
BX0033	236	EXP-A980	12	MP0042/3	156
BX0034	235	FX0180	314	MP0045/1D	157
BX0035	235	FX0185	314	MP0045/1D1	159
BX0036	236	FX0267	312	MP0045/1D2	159
BX0037	236	FX0280	314	MP0045/1E	158
BX0123	235	FX0285	314	MP0045/1E1	160
BXS001/1	232	FX0296	308	MP0045/1E2	160
BXS002/1	232	FX0296/1	308	MP0045/3D	157
BXS003/1	232	FX0296/S	308	MP0045/3E	158
BXS011/1	232, 234	FX0321	312	MP0050	150
BXS012/1	232, 234	FX0326	313	MP0050/2	150
BXS013/1	232, 234	FX0327	313	MPB031	149
BXS016	232	FX0330	311	MPB037	149
BXS017	232	FX0331	313	MPB038	149
BXS018	232	FX0342	311	MPI001	146
BZH01/Z0000/01	280	FX0345	310	MPI001/RP	148
BZH01/Z0000/10	281	FX0354	306	MPI002	147
BZH09/Z0000/01	282	FX0354/S	306	MPI002/FL	148
BZH11/Z0000/00	284	FX0357	303	MPZ016	176
BZH11/Z0000/10	283	FX0359	303	MPZ019	177
BZM27/Z0000/57B	285	FX0360	312	MPZ022	178
BZV01/Z0000/01	271	FX0365	310	MPZI019	177
BZV01/Z0000/10	272	FX0367	303	MPZI022	178
BZV03/Z0000/02	273	FX0369	303	MPZI022/L	179

# Part No. Index

PF0001/28	244	PX0414/0M50	81	PX0707/P/06	24
PF0001/PC	244	PX0414/1M00	81	PX0707/P/09	24
PF0002/28	244	PX0414/xMxx	81	PX0707/P/12	24
PF0006/28	249	PX0415/1	81	PX0707/P/25	24
PF0007/28	249	PX0416/1M00	81	PX0708/P/03	23
PF0011/10/28	245	PX0416/3M00	81	PX0708/P/09	23
PF0011/10/PC	245	PX0416/5M00	81	PX0708/P/12	23
PF0016/10/28	249	PX0416/xMxx	81	PX0708/P/25	23
PF0030/28	246	PX0441/2M00	76, 91	PX0709/P/02	23
PF0030/PC	246	PX0441/3M00	76	PX0709/P/03	23
PF0033/10/28	246	PX0441/4M50	76	PX0709/P/04	23
PNo. 9820	315	PX0442/2M00	76	PX0709/P/06	23
PNo. 11327	315	PX0442/3M00	76	PX0709/P/07	23
PNo. 11328	262	PX0442/4M50	76	PX0711	66, 73
PNo. 11987	262	PX0443	77	PX0716/48	252
PNo. 12075	262	PX0444/2M00	76	PX0717/x/xx/ST	253
PNo. 12237	26	PX0444/3M00	76	PX0718/x/xx/ST	252
PNo. 12297	315	PX0444/4M50	76	PX0725/10/28	257
PNo. 12760	315	PX0446	77, 91	PX0727/P	23
PNo. 12855	26	PX0447	77	PX0728/P	22
PNo. 12932	315	PX0456	77	PX0729/P	22
PNo. 13027	25	PX0457	78	PX0730/P	23
PNo. 13027/1	25	PX0458	78	PX0731/P	22
PNo. 13027/3	25	PX0459	77	PX0732/P	22
PNo. 13170	25	PX0460/A	71	PX0733	26, 66, 73
PNo. 13826	25	PX0460/B	71	PX0734	26
PNo. 14025	25, 57	PX0464	73	PX0735/P	23
PNo.14025	49	PX0480	36, 42, 78, 81, 91	PX0736/P	22
PNo. 14025/5AMP	25	PX0480/1	36	PX0737/P	22
PNo 14064	262	PX0481	36, 81	PX0738/P	23
PNo 14228	261	PX0482	36, 42, 91	PX0739/P	22
PNo. 14232	25	PX0483	36	PX0740/P	22
PNo.14232	49	PX0484	36, 78	PX0744/P	23
PNo. 14232/1	25	PX0485	42, 78, 81, 91	PX0745/P	22
PNo.14232/2	49	PX0575/10/28	241	PX0746/P	22
PNo 14277	261	PX0575/10/PC	241	PX0747/P	23
PNo 14317	261	PX0578/63	253	PX0748/P	22
PNo 14340	261	PX0579/28	242	PX0749/P	22
PNo. 14917	49	PX0580/28	242	PX0756/P	24
PNo.14944	49	PX0580/PC	243	PX0757/P	24
PNo. 14944/SP	57	PX0580/PC/7	243	PX0758/P	24
PNo.14945	49	PX0587	240	PX0760/P	24
PNo. 14945/SP	57	PX0587/SE	240	PX0761/P	24
PNo.14946	49	PX0588	240	PX0762/P	24
PNo.15019	49	PX0590/28	247	PX0764/P	24
PNo. 15019/SP	57	PX0591/63	259	PX0765/P	24
PNo.15021	49	PX0592/15/63	259	PX0766/P	24
PNo. 15021/SP	57	PX0595/10/28	247	PX0767/P	24
PNo. 15065/SP	57	PX0596	258	PX0768/P	24
PS00/A	292	PX0597	247	PX0769/P	24
PS01/A	292	PX0598	258	PX0776/P	22
PS02/A	294	PX0599	258	PX0777	68
PS03/A	294	PX0675/28	254	PX0777/4Pole	29
PS20/A	296	PX0675/PC	254	PX0777/6Pole	29
PS21/A	296	PX0685	250 - 251	PX0777/CAT5ESTP	68
PS25/A	298	PX0686	250 - 251	PX0777/STP	68
PS26/A	298	PX0686/SE	250	PX0777/UTP	68
PX0400	35	PX0690/28	248	PX0778/P	22
PX0401	35	PX0691/10/28	248	PX0779/P	23
PX0402	35	PX0691/10/PC	248	PX0781/P	24
PX0407	84	PX0695/10/28	255	PX0783/10/28	256
PX0408	84	PX0695/10/PC	255	PX0793/1	256
PX0409	84	PX0700	22	PX0793/28	256
PX0410	35, 41	PX0705/28	257	PX0794/P	22
PX0411	35, 41	PX0705/28	257	PX0795/P	22
PX0412	36	PX0707/P/03	24	PX0796/P	23
PX0413	36, 42	PX0707/P/04	24	PX0797/P	24

# Part No. Index

PX0798/P	24	PX0960	18	PXMBNI08RPM	112
PX0799	26	PX0970	18	PXMBNI12	130
PX0800	31	PX0990	18	PXMBNI12FBF	124
PX0801	31	PX0991	18	PXMBNI12FIM	124
PX0802	31	PX0992	18	PXMBNI12RPF	122
PX0803	31	PXA911/05/P	16	PXMBNI12RPM	122
PX0805	31	PXA911/10/P	16	PXMBNI16FBF	133
PX0810	32	PXD100/050/01/1	264	PXMBNI16FIM	133
PX0811	32	PXD200	266	PXMBNI16RPF	134
PX0820/P	22	PXD201	266	PXMBNI16RPM	134
PX0821/P	22	PXD301/050/01/1	264	PXMBNI23FBF	137
PX0822/P	23	PXD301/050/07/1	265	PXMBNI23FIM	137
PX0823/P	24	PXD303/050/01/1	264	PXMBNI23FPM	137
PX0824/P	24	PXD303/050/08/1	265	PXMBNI23RAF	137
PX0833	64	PXD306/050/01/1	264	PXP6010/02P	47
PX0833/E	64	PXD500/061/10/1	267	PXP6010/03P	47
PX0835	66, 73	PXD701/061/10/1	267	PXP6010/08P	47
PX0836/2M00	64	PXD703/061/10/1	267	PXP6010/16P	47
PX0836/3M00	64	PXD706/061/10/1	267	PXP6010/22P	47
PX0836/5M00	64	PXM6010/02P	48	PXP6011/02P	47
PX0837/2M00	64	PXM6010/03P	48	PXP6011/03P	47
PX0837/3M00	64	PXM6010/08P	48	PXP6011/08P	47
PX0837/5M00	64	PXM6010/16P	48	PXP6011/16P	47
PX0838/2M00	64	PXM6010/22P	48	PXP6011/22P	47
PX0838/3M00	64	PXM6011/02P	48	PXP6012/02P	47
PX0838/5M00	64	PXM6011/03P	48	PXP6012/03P	47
PX0839/90	65	PXM6011/08P	48	PXP6012/08P	47
PX0839/IDC	66	PXM6011/16P	48	PXP6012/16P	47
PX0839/PC	65	PXM6011/22P	48	PXP6012/22P	47
PX0840/A/2M00	70	PXM6012/02P	48	PXP6033TP	99
PX0840/A/3M00	70	PXM6012/03P	48	PXP6033TP/E	99
PX0840/A/5M00	70	PXM6012/08P	48	PXP6034/A	99
PX0840/B/2M00	70	PXM6012/16P	48	PXP6034/B	99
PX0840/B/3M00	70	PXM6012/22P	48	PXP6037/A/2M00	99
PX0840/B/5M00	70	PXM6033TP	100	PXP6037/A/3M00	99
PX0841/AB/2M00	70	PXM6034/A	100	PXP6037/A/5M00	99
PX0841/AB/3M00	70	PXM6034/B	100	PXP6038/B/2M00	99
PX0841/AB/5M00	70	PXM6081	50, 101	PXP6038/B/3M00	99
PX0842/A	71	PXM6082	50	PXP6038/B/5M00	99
PX0842/B	71	PXM6083	50, 101	PXP6040/A/2M00	94
PX0843/A	71	PXM7010/02P	56	PXP6040/A/3M00	94
PX0843/B	71	PXM7010/03P	56	PXP6040/A/5M00	94
PX0844/A/0M50/A	71	PXM7010/06P	56	PXP6040/B/2M00	94
PX0844/A/0M50/B	71	PXM7010/10P	56	PXP6040/B/3M00	94
PX0844/B/0M50/A	71	PXM7010/32P	56	PXP6040/B/5M00	94
PX0844/B/0M50/B	71	PXM7011/02P	56	PXP6041/AB/2M00	94
PX0845/A	72	PXM7011/03P	56	PXP6041/AB/3M00	94
PX0845/B	72	PXM7011/06P	56	PXP6041/AB/5M00	94
PX0848/A	72	PXM7011/10P	56	PXP6042/A	95
PX0848/B	72	PXM7011/32P	56	PXP6042/B	95
PX0849/A	72	PXM7012/02P	56	PXP6043/A	95
PX0849/B	72	PXM7012/03P	56	PXP6043/B	95
PX0852	73	PXM7012/06P	56	PXP6081	96, 101
PX0870	65	PXM7012/10P	56	PXP6083	96, 101
PX0870/E	65	PXM7012/32P	56	PXP6088	50
PX0888	66	PXM7081	58	PXP7010/02P	55
PX0911/02/P	16	PXM7082	58	PXP7010/03P	55
PX0911/03/P	16	PXM7083	58	PXP7010/06P	55
PX0911/04/P	16	PXM7090	57	PXP7010/10P	55
PX0911/07/P	16	PXMBNI05FPM	107	PXP7010/32P	55
PX0911/10/P	16	PXMBNI05RPF	107	PXP7011/02P	55
PX0931/10/P	17	PXMBNI05RPM	107	PXP7011/03P	55
PX0941	18	PXMBNI08FBF	114	PXP7011/06P	55
PX0941/02/P	17	PXMBNI08FIM	114	PXP7011/10P	55
PX0941/04/P	17	PXMBNI08FPM	113	PXP7011/32P	55
PX0941/10/P	17	PXMBNI08RPF	112	PXP7012/02P	55
PX0950	18			PXP7012/03P	55

## Part No. Index

PXP7012/06P	55
PXP7012/10P	55
PXP7012/32P	55
PXP7081	58
PXP7082	58
PXP7088	58
PXPPAM08FBF	114
PXPPAM08FIM	114
PXPPAM12	130
PXPPAM12FBF	123
PXPPAM12FIM	123
PXPPAM12RAF	123
PXPPAM12RAM	123
PXPTPU05FBF / PXPPVC05FBF	109
PXPTPU05FIM / PXPPVC05FIM	109
PXPTPU05RAF / PXPPVC05RAF	108
PXPTPU05RAM / PXPPVC05RAM	108
PXPTPU08FBF / PXPPVC08FBF	117
PXPTPU08FIM / PXPPVC08FIM	118
PXPTPU08RAF / PXPPVC08RAF	115
PXPTPU08RAM / PXPPVC08RAM	116
PXPTPU12FBF / PXPPVC12FBF	126
PXPTPU12FIM / PXPPVC12FIM	129
PXPTPU12RAF / PXPPVC12RAF	125
PXPTPU12RAM / PXPPVC12RAM	127
SA2800	32
SA3147	32
SA3148	32
SA3148/1	32
SA3149	32
SA3149/1	32
SA3150	32
SA3179	37
SA3179/1	37, 43
SA3180	25, 37
SA3180/1	25, 37, 43
SA3229	32
SA3230	32
SA3241	32
SA3242	32
SA3243	32
SA3244	32
SA3253	25
SA3319	32
SA3320	32
SA3347	25, 37
SA3347/1	25, 37, 43
SA3348	25, 37
SA3348/1	25, 37, 43
SA3349	37
SA3349/1	37, 43
SA3350	37
SA3350/1	37, 43
SA3426	25
SA3542/P	49, 57
SA3542/S	57
SA3544/P	49, 57
SA3544/S	57
SA3545/P	49
VS0001	174
VS0002	174



# Index

12mm Switches 181 - 186  
400 Series Buccaneer 8, 34 - 45, 62, 75 - 92  
900 Series Buccaneer 8, 15 - 20  
4000 Series Buccaneer 6, 8, 40 - 45  
6000 Series Buccaneer 46 - 53, 62, 93 - 98, 103  
7000 Series Buccaneer 54 - 61

## A

### Accessories

400 Series 36, 42  
400 Series - Mini USB 78  
400 Series - SMB Buccaneer 81  
900 Series 18  
6000 Series 49 - 50, 96  
7000 Series 57 - 58  
Fuseholders 315  
IEC Connectors 261 - 262  
Mini Buccaneer 32  
Standard Buccaneer 25 - 26  
Standard Buccaneer - Ethernet 66  
Standard Buccaneer - USB 73  
Antenna 84  
Appliance Couplers 47  
EN60 320-1 240 - 249, 252, 258

### Appliance Outlets

EN60 320-2-2 250 - 257, 259  
Atex Zone 2 Connectors 11

## B

Back Shell 26  
Battery Holders 230 - 236  
IP67 232  
Panel Mounting 233 - 234  
PC/Base Mounting 235 - 236

### Bezel, Power Inlet/Outlet

Horizontal, Snap fit 280 - 284  
Vertical, Flange screw fixing 286 - 287  
Vertical, Snap fit 271 - 279  
Blanking plates 47  
Blanking plugs 32  
Brass Chrome Plated Vandal Resistant Switches 149

## C

C14 and C16 IEC Inlet - Vertical 273  
C14 Type 241  
C15 Type 239, 247  
C16 Type 238, 247, 269 - 270, 273 - 276  
C18 Type 238, 248 - 249  
C19 Type 239, 258  
C20 Type 238, 258, 269 - 270, 277  
Cable Braid Termination 50 - 51, 57  
Cable Mounting 240, 247, 250, 258  
Captive Carrier Fuseholders 302 - 306, 308 - 311

### Circuit Protection

Fuseholders 300 - 315  
Class I Connectors 240 - 247, 250 - 256, 258 - 259  
Class II Connectors 248 - 249, 257  
Clips, Retaining 260  
Combined Switch / Lampholder 224

### Connectors

400 Series Buccaneer 8, 34 - 45  
400 Series - Mini USB Buccaneer 62, 75 - 79, 90 - 92  
400 Series - SMB Buccaneer 62, 80 - 82  
400 Series - Wireless Buccaneer 83  
900 Series Buccaneer 8, 15 - 20  
6000 Series Buccaneer 46 - 53  
6000 Series Ethernet Buccaneer 62, 99 - 102  
6000 Series USB Thermo Plastic 94 - 98  
7000 Series Buccaneer 8, 54 - 61  
C14 IEC Fused Inlet 286 - 287  
Cable Mounting 240, 247, 250, 258  
EN60 320-1 240 - 249, 252, 258  
EN60 320-2-2 250 - 257, 259  
EXPLORA 10 - 14  
Fused 244 - 246, 249, 252  
Mains Filters 291 - 299  
Mini Buccaneer 30  
PCB Mounting 24, 36, 42, 65, 72, 241, 2  
43 - 246, 248, 254 - 255

### Polysnap Power Inlet Modules horizontal.

See Polysnap Power Inlet Modules\*  
Rewirable 240 - 247, 250, 258  
Standard Buccaneer 8, 21, 23 - 26  
Standard Buccaneer - Ethernet 63 - 68  
Standard Buccaneer - USB 62, 69 - 74  
Contact Carrier Removal Tool 49, 57

### Contact Insertion/Extraction Tools

400 Series 37, 43  
7000 Series 57  
Mini Serie 32  
Standard Series 25

### Contacts, Buccaneer

400 Series 37, 43  
6000 Series 49  
7000 57  
Mini Series 32  
Standard Series 25

### Cord Sets

400 Series - Mini USB 76, 91  
400 Series - SMB 81  
6000 Series Ethernet 99 - 100  
6000 Series USB 94  
Standard Ethernet 64  
Standard USB 70

### Cover - Insulation

Fuse 315  
Inlets 261 - 262  
Outlets 261 - 262

### Crimp Tools

400 Series 37, 43  
6000 Series 49  
7000 Series 57  
Mini Buccaneer Series 32  
Standard Buccaneer - Ethernet 66  
Standard Buccaneer Series 25

## D

Diode, Light Emitting 316 - 323

### Distribution Boxes

Compact 266  
Panel 264 - 265  
Rectangular 264 - 266  
Square 267  
Switched 264 - 265, 267  
Domed Vandal Resistant Switches 151 - 152

## E

EMC Filtering 291 - 299  
EMI Mains Filters 291 - 299  
EN60 320-1 240 - 249, 252, 258  
EN60 320-1 Appliance Couplers 240 - 249, 252, 258  
EN60 320-2-2 250 - 257, 259  
EN60 320-2-2 Appliance Couplers 250 - 257, 259

### Ethernet Waterproof Buccaneer

6000 Series Ethernet Buccaneer 62, 99 - 100  
Standard Buccaneer - Ethernet 64  
EXPLORA 10 - 14  
Explora Zone 2 Connector 8, 10 - 14

## F

Filament Lamp 324 - 330

### Filters, Mains

Base Mounting 294 - 297  
Bulkhead Mounting 294 - 297

### Fused

Single 296 - 297  
Twin 298 - 299  
Panel Mounting 292 - 299  
Polysnap 288 - 290

### Fixing Nut

Hex nylon 217  
Knurled brass 217  
Nickel plated 14, 19, 215  
Fuse Cover 315  
Fused Inlet 244 - 246, 249  
Fuseholders 269, 301 - 315  
6.3 x 32mm 300, 305, 307, 309, 313 - 314  
Accessories 315  
Base Mounting 312 - 313  
Captive Carriers 302 - 306, 308 - 311  
In-Line 314  
IP66 310, 314  
IP68 309  
Panel Mounting 300 - 306, 308  
PCB Mounting 311 - 312  
Snap fit 302 - 304

## G

### Glands/Gland Packs

400 Series 36, 42, 91  
900 Series 18  
6000 Series 50  
7000 Series 58  
Explora 12  
Mini Series 33  
Guard 216

## H

### Hazardous Area Connectors

EXPLORA 9 - 14

## I

IEC Connectors 237 - 291  
IEC Distribution Units 263 - 267  
IEC Inlet/ Outlet Modules 252 - 253  
Illuminated Latching Switches 160  
Illuminated Momentary Switches 159  
Illuminated Vandal Resistant Switches 146 - 148  
Indicators 316 - 323  
LED 317 - 321  
Sealed 318 - 319, 321  
Vandal Resistant LED 317 - 318  
Insertion Tools 25, 32, 37, 43, 57

### Insulation Boots

Connectors 261 - 262  
Fuseholders 315

### IP66 Rated

6000 Series 52  
7000 Series 60  
Fuseholders 310  
Indicators 320  
Switches 146

### IP67 Rated

Battery Holders 232  
Indicators 317 - 318

### IP68 Rated

400 Series Buccaneer 8, 34 - 45  
400 Series - SMB Buccaneer 62, 80 - 82  
900 Series Buccaneer 8, 15 - 20  
Antenna 84  
Fuseholders 309  
Mini Buccaneer 8, 30 - 33  
Sealed Inline Cable Joiner 29  
Standard Buccaneer 8, 21, 23 - 26, 62 - 74  
Standard Buccaneer - USB 62, 69 - 74  
Switches 145, 150, 152 - 154  
Wireless 62, 83 - 89

### IP69K Rated

900 Series Buccaneer 8, 15 - 20  
6000 Series Buccaneer 8, 46  
7000 Series Buccaneer 8, 54 - 61  
Piezo Switches 175 - 180  
Standard Buccaneer 8, 21, 23 - 26, 62 - 74

# Index

## L

### Lampholders

E12 224

E14 224

Large Diameter Vandal Resistant Switches 150

Latching Switches 158, 160

Latching Vandal Resistant Switches 179

### LED

Indicators 317 - 318

Switches 146 - 148

Low Profile Vandal Resistant Switches 144 - 145

## M

M5 Series 106 - 110

M8 Series 111 - 119

M12 Series 120 - 131

M16 Series 133 - 135

M23 Series 136 - 138

### Mains Filters

Base Mounting 294 - 297

Bulkhead Mounting 294 - 297

### Fused

Single 296 - 297

Twin 298 - 299

Panel Mounting 292 - 299

Polysnap 288 - 290

Mains Inlet Modules 271 - 272, 274 - 290

### Mains Inlets

C13 Type 240

C14 Type 238, 241 - 246, 252

C15 Type 247

C16 Type 247

C18 Type 248 - 249

C19 Type 258

C20 Type 258

Class I 240 - 247, 250 - 256, 258 - 259

Class II 248 - 249, 257

Filtered 292 - 295

Flange Mount 242 - 244, 246 - 249

### Fused

PC Mount 241, 243 - 246

Single 244, 248

Single 245

Snap-fit 241, 245 - 249

Twin 246

Vertical Flange Mount 242

### Mains Outlets

Class 1 252 - 256

Class 11 257

Five Way 252 - 253

Flange Mount 253 - 254

Four Way 252 - 253

PC Mount 254 - 255

Seven way 252 - 253

Shuttered 256

Six way 252 - 253

Snap-fit 252 - 253, 255 - 257, 259

Three way 252 - 253

Two way 252 - 253

Miniature rocker switch 190, 192

Mini Buccaneer 8, 30 - 33

Mini USB Buccaneer 62, 76 - 78, 91

Momentary Switches 156 - 157, 159

Distribution Units 139 - 142

## N

Neck Seal 215, 217

## O

### Opto

Led Indicators 317 - 319

Vandal Resistant LED Indicators 317 - 318

### Overmoulded Cable Assemblies

400 Series Buccaneer 35, 41

6000 Series Buccaneer USB 62, 95

6000 Series Ethernet Buccaneer 62, 99

Mini USB Buccaneer 62, 76, 91

Standard Buccaneer - Ethernet 64

Standard Buccaneer - USB 70

## P

### Panel Sealing Washers

W46 199, 203, 205

### PCB Mounting

400 Series Buccaneer 35, 41

Battery Holders 235 - 236

Connectors 24, 36, 42, 65, 72, 241 - 242, 244 - 247, 249, 254 - 255

Ethernet 64

Fuseholders 311 - 312

Mini USB Buccaneer 77 - 78

Standard Buccaneer 24

Standard Buccaneer - USB 72

PC Spills 255

Piezo Switches 175 - 180

### Plugs & Sockets

EN60 320-1 240 - 249, 252, 258

EN60 320-2-2 250 - 257, 259

Filtered 292 - 299

Fused 244 - 245, 249

PCB Mounting 24, 36, 42, 65, 72, 241, 244 - 246, 248, 254 - 255

Snap-fit 241, 245 - 249, 252, 254 - 257, 259

Waterproof 15 - 29, 34 - 45, 47 - 53, 55 - 61

Polarising/Blanking Pins 32

### Polyflange Power Inlet Modules

Side fixing 286 - 287

Top fixing 286 - 287

### Polysnap Power Inlet Modules

Horizontal 280 - 284

Vertical 271 - 278

Prominent Button Vandal Resistant Switches 153 - 154

Toggle Switch 73, 199, 201, 215, 217, 243, 261, 315

Push Button Switches 143, 155, 164 - 165, 168, 172 - 173

## R

Refridgerator Switches 6, 143, 219

Retaining Clips (Connectors) 260

RJ45 Waterproof Connectors 62 - 67, 99 - 102

### Rocker Switches

High Inrush Switches 202, 210

Lit Rocker 204

### Miniature

Splash Resistant Rocker Switches 198

Thinline Rocker Switches 188

## S

### Sealed

Battery Holders 232

Connectors 15 - 45, 47 - 53, 55 - 61, 99

Fuseholder 305

Fuseholders 308, 312

LED Indicators 317 - 318, 320

Switches 144 - 154

### Sealing Caps, Buccaneer

400 series 36, 42

900 Series 18

6000 Series 50

6000 Series Ethernet 101

7000 Series 58

EXPLora 12

Mini Buccaneer 32

Mini USB Buccaneer 78

SMB 81

Standard 26

USB 73

Security Switches 144 - 154

Selectors Voltage 174

Slide Switches 6, 225 - 226, 228

SMB Antenna 84

SMB Buccaneer 62, 80 - 82

Snap action switches 162, 172

### Snap-fit

Fuseholders 302 - 304

IEC Inlets 241, 245 - 249

IEC Outlets 252 - 253, 255 - 257, 259

### Splash Resistant

Refrigerator Switches 198, 200, 207, 221

Rocker Switches 200

Standard Buccaneer 8, 21, 23 - 29, 62 - 74

### Standard Buccaneer Waterproof

Standard Buccaneer - Ethernet 64

### Standard Series

Glands/Gland Packs 12, 25

Switches 143 - 148, 150 - 161, 164 - 165, 174 - 162

Piezo Switches 175 - 180

Push Button 143, 155 - 160, 164 - 165

Security 144 - 154

### Vandal Resistant

Brass Chrome Plated 149

Domed 151 - 152

Illuminated 146 - 148

Low Profile 144 - 145, 149 - 150, 157 - 158, 306

Voltage Selectors 174

## T

Thinline Rocker Switches 188

### Through Panel Sealed

6000 Series Buccaneer - USB 94

Illuminated Switches 147

Standard Buccaneer - USB 71

Toggle Switches 6, 143, 214 - 215

### Tools

Crimp 25, 32, 37, 43, 66

Insertion 25, 32, 37, 43

Touchproof Fuseholders 302 - 305, 309

## U

### USB Buccaneer Waterproof

400 Series - Mini USB Buccaneer 62, 75 - 79, 90 - 92

6000 Series Buccaneer 94

Standard Buccaneer - USB 62, 69 - 74

## V

### Vandal Resistant

LED Indicators 317 - 318

Switches 146 - 148

Voltage Selectors 174

## W

### Waterproof

6000 Series Buccaneer - USB 94

Antenna 62, 84 - 89

Battery Holders 232

Buccaneer for Data 63 - 84, 90 - 92, 94 - 103

Fuseholders 309 - 310, 314

LED Indicators 317 - 318, 320

Mini USB Buccaneer 75, 90

SMB Buccaneer 62, 80 - 84

Standard Buccaneer - Ethernet 62 - 68

Standard Buccaneer - USB 62, 69

Switches 144 - 154

Wireless Buccaneer 62, 84 - 89

## Z

Zone 2 Connectors 9 - 14

Zone 22 Connectors 9 - 14

## Europe

Elektron Technology  
Broers Building,  
JJ Thomson Avenue, Cambridge  
CB3 0FA UK  
Tel: +44 (0)1223 371 000  
Fax: +44 (0)1223 350 642

## The Americas

Elektron Technology  
11930 Hamden Place  
Santa Fe Springs  
CA 90670 USA  
Tel: +1 760-343-3650  
Fax: +1 760-343-3345  
[americas@elektron-technology.com](mailto:americas@elektron-technology.com)

## China & Asia

Elektron Technology  
Room 902 No. 568 Hengfeng Road,  
Henhui International Building,  
Shanghai 200070, PR China  
Tel: +86 21 6040 0060  
[asia@elektron-technology.com](mailto:asia@elektron-technology.com)

