



Page 10-2

#### **GX SERIES**

- IEC conventional free air thermal current lth 16A...40A ratings
- Square-shaped contact body
- IEC IP20 degree of protection of contacts
- IEC IP65 degree of protection on front, standard supplied.



Page 10-12

#### **GN SERIES**

- IEC conventional free air thermal current lth 16A...125A ratings
- Round-shaped contact body
- IEC IP00 degree of protection of contacts
- IEC IP40 degree of protection on front, standard supplied.



- Suitable for circuit connection, changeover, switching on and off as well as motor starting
- Possible special circuit schemes
- IEC IP40 or IP65 front degree of protection
- 2-screw fixing
- Wide range of features.

	SEC.	PAGE	PAGE
	SERIES	GX	GN
<b>Front mount versions</b>			
On/Off switches. U version, front mount .....	10	-	2 12
Changeover switches with or without O (OFF). U version, front mount .....	10	-	3 13
Motor switches. U version, front mount .....	10	-	4 14
Voltmeter switches. Ammeter switches. U version, front mount .....	10	-	5 15
On/Off switches. U11 version, front ring mount with handle operation for Ø22mm/Ø0.88" fixing .....	10	-	6 16
On/Off switches. U12 version, front ring mount with key operation for Ø22mm/Ø0.88" fixing .....	10	-	6 16
On/Off safety switches. U25-U65 version, front mount with red/yellow padlockable handle .....	10	-	6 16
On/Off switches. U47 version, front snap on mount with handle operation for Ø22mm/Ø0.88" fixing .....	10	-	7 —
On/Off switches. U29D version, front snap on mount with key operation for Ø22mm/Ø0.88" fixing .....	10	-	7 —
<b>Rear mount versions</b>			
On/Off switches. 088-098-099 version, door coupling with red/yellow padlock system .....	10	-	8 17
On/Off switches. Changeover switches. Voltmeter switches. Ammeter switches. 048 version, modular DIN rail (IEC/EN 60715) mount .....	10	-	9 —
<b>Versions in enclosure</b>			
On/Off switches. Changeover switches. P version .....	10	-	10 18
Motor switches. P version with rotating handle .....	10	-	10 18
On/Off switches. P25 version with padlockable handle .....	10	-	10 18
<b>Accessories</b> .....	10	-	11 19
<b>Special circuit scheme form</b> .....	10	-	20 20
<b>Dimensions</b> .....	10	-	22 23
<b>Wiring diagrams</b> .....	10	-	25 25
<b>Technical characteristics</b> .....	10	-	26 26

### U version front mount. ON/OFF switches



Order code	IEC current AC1	Front plate size	Qty per pkg	Weight
	[A]	[mm]	n°	[kg]

ON/OFF SWITCHES.

One-pole – 1 wafer – scheme 90.

<b>GX16 90 U</b>	16	□ 48	1	0.096
<b>GX20 90 U</b>	20	□ 48	1	0.096
<b>GX32 90 U</b>	32	□ 65	1	0.192
<b>GX40 90 U</b>	40	□ 65	1	0.194

Two-pole – 1 wafer – scheme 91.

<b>GX16 91 U</b>	16	□ 48	1	0.100
<b>GX20 91 U</b>	20	□ 48	1	0.100
<b>GX32 91 U</b>	32	□ 65	1	0.204
<b>GX40 91 U</b>	40	□ 65	1	0.206

Three-pole – 2 wafers – scheme 10.

<b>GX16 10 U</b>	16	□ 48	1	0.115
<b>GX20 10 U</b>	20	□ 48	1	0.115
<b>GX32 10 U</b>	32	□ 65	1	0.242
<b>GX40 10 U</b>	40	□ 65	1	0.244

Four-pole – 2 wafers – scheme 92.

<b>GX16 92 U</b>	16	□ 48	1	0.118
<b>GX20 92 U</b>	20	□ 48	1	0.122
<b>GX32 92 U</b>	32	□ 65	1	0.252
<b>GX40 92 U</b>	40	□ 65	1	0.254

Front plate size:  
48x48mm = 1.9x1.9"  
65x65mm = 2.6x2.6"  
90x90mm = 3.5x3.5".

Type	UL/CSA general use [A]	UL/CSA horsepower ratings						Max IEC AC23 power [kW] at 400V
		1 phase		3 phases				
		120V	230V	200V	230V	480V	600V	
GX16	12	3/4	1	1 1/2	3	5	5	6.5
GX20	15	3/4	1 1/2	1 1/2	3	5	5	7.5
GX32	32	1 1/2	3	3	7 1/2	15	15	15
GX40	40	2	5	5	10	15	15	18.5

#### General characteristics

- IEC 16...40A conventional free air thermal current Ith ratings
- Conductivity: 10mA 5V
- Extended mechanical and electrical life
- Rotation angles: 30°, 45°, 60° and 90°
- Silver-alloy dual-breaking contacts
- Direct (positive) opening action ⊖; safety function according to IEC/EN 60947-5-1
- IEC IP65 front degree of protection; IEC IP20 protection of contacts
- Legend marking is standard supplied as illustrated in the order code table; any other on request.

#### Selection guide

See page 10-26.

#### Optional

Enlarged front plate for GX16-GX20 (65x65mm instead of standard 48x48):

Add "H" after the switch rating in the order code  
E.g. GX16H 10 U.

Enlarged front plate for GX32-GX40 (90x90mm instead of standard 65x65):

Add "H" after the switch rating in the order code  
E.g. GX32H 10 U.

#### Special versions

In addition to standard types, particular versions are available with special operating circuit schemes.

See page 10-20.

#### Example of U version switch mounting

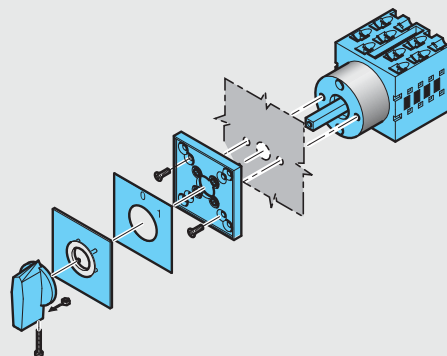

#### Certifications and compliance

Certifications obtained: EAC; UL Listed, for USA and Canada (File E155982) as Manual Motor Controllers. Compliant with standards: IEC/EN 60947-1, IEC/EN 60947-3, IEC/EN 60947-5-1, IEC/EN 61058-1, UL508, CSA C22.2 n°14.

**U version front mount.**  
**Changeover switches with 0 position.**  
**Changeover switches without 0 position**



Order code	IEC current AC1	Front plate size	Qty per pkg	Weight
	[A]	[mm]	n°	[kg]

CHANGEOVER SWITCHES WITH 0.  
 One-pole – 1 wafer – scheme 51.

<b>GX16 51 U</b>	16	□ 48	1	0.098
<b>GX20 51 U</b>	20	□ 48	1	0.098
<b>GX32 51 U</b>	32	□ 65	1	0.210
<b>GX40 51 U</b>	40	□ 65	1	0.212



Two-pole – 2 wafers – scheme 52.

<b>GX16 52 U</b>	16	□ 48	1	0.120
<b>GX20 52 U</b>	20	□ 48	1	0.120
<b>GX32 52 U</b>	32	□ 65	1	0.270
<b>GX40 52 U</b>	40	□ 65	1	0.272



Three-pole – 3 wafers – scheme 53.

<b>GX16 53 U</b>	16	□ 48	1	0.148
<b>GX20 53 U</b>	20	□ 48	1	0.148
<b>GX32 53 U</b>	32	□ 65	1	0.327
<b>GX40 53 U</b>	40	□ 65	1	0.326



Four-pole – 4 wafers – scheme 75.

<b>GX16 75 U</b>	16	□ 48	1	0.164
<b>GX20 75 U</b>	20	□ 48	1	0.172
<b>GX32 75 U</b>	32	□ 65	1	0.378
<b>GX40 75 U</b>	40	□ 65	1	0.380



CHANGEOVER SWITCHES WITHOUT 0.

One-pole – 1 wafer – scheme 54.

<b>GX16 54 U</b>	16	□ 48	1	0.098
<b>GX20 54 U</b>	20	□ 48	1	0.098
<b>GX32 54 U</b>	32	□ 65	1	0.212



Two-pole – 2 wafers – scheme 55.

<b>GX16 55 U</b>	16	□ 48	1	0.124
<b>GX20 55 U</b>	20	□ 48	1	0.124
<b>GX32 55 U</b>	32	□ 65	1	0.266



Three-pole – 3 wafers – scheme 56.

<b>GX16 56 U</b>	16	□ 48	1	0.148
<b>GX20 56 U</b>	20	□ 48	1	0.148
<b>GX32 56 U</b>	32	□ 65	1	0.318



Four-pole – 4 wafers – scheme 69.

<b>GX16 69 U</b>	16	□ 48	1	0.164
<b>GX20 69 U</b>	20	□ 48	1	0.172
<b>GX32 69 U</b>	32	□ 65	1	0.380



Front plate size:  
 48x48mm = 1.9x1.9"  
 65x65mm = 2.6x2.6"  
 90x90mm = 3.5x3.5"

Type	UL/CSA general use [A]	UL/CSA horsepower ratings						Max IEC AC23 power [kW] at 400V
		1 phase		3 phases				
		120V	230V	200V	230V	480V	600V	
GX16	12	3/4	1	1 1/2	3	5	5	6.5
GX20	15	3/4	1 1/2	1 1/2	3	5	5	7.5
GX32	32	1 1/2	3	3	7 1/2	15	15	15
GX40	40	2	5	5	10	15	15	18.5

### General characteristics

- IEC 16...40A conventional free air thermal current lth ratings
- Conductivity: 10mA 5V
- Extended mechanical and electrical life
- Rotation angles: 30°, 45°, 60° and 90°
- Silver-alloy dual-breaking contacts
- Direct (positive) opening action ⊖; safety function according to IEC/EN 60947-5-1
- IEC IP65 front degree of protection; IEC IP20 protection of contacts
- Legend marking is standard supplied as illustrated in the order code table; any other on request.

### Selection guide

See page 10-26.

### Optional

Enlarged front plate for GX16-GX20 (65x65mm instead of standard 48x48):

Add "H" after the switch rating in the order code  
 E.g. GX16H 52 U.

Enlarged front plate for GX32-GX40 (90x90mm instead of standard 65x65):

Add "H" after the switch rating in the order code  
 E.g. GX32H 52 U.

### Special versions

In addition to standard types, particular versions are available with special operating circuit schemes.  
 See page 10-20.

### Example of U version switch mounting

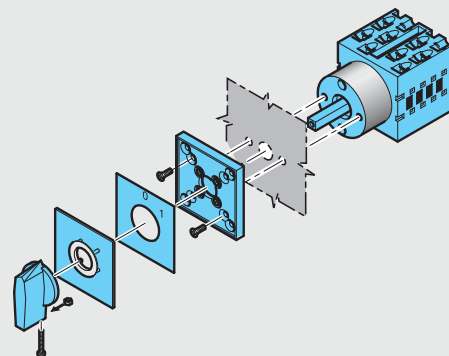

### Certifications and compliance

Certifications obtained: EAC; UL Listed, for USA and Canada (File E155982) as Manual Motor Controllers. Compliant with standards: IEC/EN 60947-1, IEC/EN 60947-3, IEC/EN 60947-5-1, IEC/EN 61058-1, UL508, CSA C22.2 n°14.

### U version front mount. Motor switches



Order code	Ith AC1 IEC	IEC power AC23A	Front plate size	Qty per pkg	Wt.
	[A]	[kW]	[mm]	n°	[kg]

#### MOTOR SWITCHES.

Reversing switches. Three-pole – 3 wafers – scheme 11.

<b>GX16 11 U</b>	16	5	□ 48	1	0.138
<b>GX20 11 U</b>	20	7.5	□ 48	1	0.140
<b>GX32 11 U</b>	32	15	□ 65	1	0.316
<b>GX40 11 U</b>	40	18.5	□ 65	1	0.318

Pole-changing switches. 4 wafers – scheme 13.

<b>GX16 13 U</b>	16	5	□ 48	1	0.166
<b>GX20 13 U</b>	20	7.5	□ 48	1	0.168
<b>GX32 13 U</b>	32	15	□ 65	1	0.400
<b>GX40 13 U</b>	40	18.5	□ 65	1	0.400

Star-delta switches. 4 wafers – scheme 12.

<b>GX16 12 U</b>	16	5	□ 48	1	0.176
<b>GX20 12 U</b>	20	7.5	□ 48	1	0.176
<b>GX32 12 U</b>	32	15	□ 65	1	0.384
<b>GX40 12 U</b>	40	18.5	□ 65	1	0.386

3-pole motor reversing switches with spring return to 0.

3 wafers – scheme 26.

<b>GX16 26 U</b>	16	5	□ 48	1	0.148
<b>GX20 26 U</b>	20	7.5	□ 48	1	0.148
<b>GX32 26 U</b>	32	18.5	□ 65	1	0.320

Type	UL/CSA general use [A]	UL/CSA horsepower ratings						Max IEC AC23 power [kW] at 400V
		1 phase		3 phases				
		120V	230V	200V	230V	480V	600V	
GX16	12	3/4	1	1 1/2	3	5	5	6.5
GX20	15	3/4	1 1/2	1 1/2	3	5	5	7.5
GX32	32	1 1/2	3	3	7 1/2	15	15	15
GX40	40	2	5	5	10	15	15	18.5

#### General characteristics

- IEC 16...40A conventional free air thermal current Ith ratings
- Conductivity: 10mA 5V
- Extended mechanical and electrical life
- Rotation angles: 30°, 45°, 60° and 90°
- Silver-alloy dual-breaking contacts
- Direct (positive) opening action ⊖; safety function according to IEC/EN 60947-5-1
- IEC IP65 front degree of protection; IEC IP20 degree of protection of contacts
- Legend marking is standard supplied as illustrated in the order code table; any other on request.

#### Selection

See page 10-26.

#### Optional

Enlarged front plate for GX16-GX20 (65x65mm instead of standard 48x48): Add "H" after the switch rating in the order code E.g. GX16H 11 U.

Enlarged front plate for GX32-GX40 (90x90mm instead of standard 65x65): Add "H" after the switch rating in the order code E.g. GX32H 11 U.

#### Special versions

In addition to standard types, particular versions are available with special operating circuit schemes. See page 10-20.

#### Example of U version switch mounting

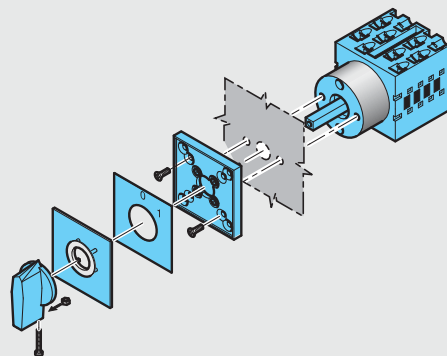

#### Certifications and compliance

Certifications obtained: EAC; UL Listed, for USA and Canada (File E155982) as Manual Motor Controllers. Compliant with standards: IEC/EN 60947-1, IEC/EN 60947-3, IEC/EN 60947-5-1, IEC/EN 61058-1, UL508, CSA C22.2 n°14.

Valid for motor, voltmeter and ammeter switches:

Front plate size:

48x48mm = 1.9x1.9"

65x65mm = 2.6x2.6"

90x90mm = 3.5x3.5"

### U version front mount. Voltmeter switches. Ammeter switches



Order code	IEC current AC1 [A]	Front plate size [mm]	Qty per pkg n°	Weight [kg]
<b>VOLTMETER SWITCHES.</b>				
Phase-Neutral L1-N/L2-N/L3-N – 2 wafers – scheme 68.				
<b>GX16 68 U</b>	16	□ 48	1	0.120
Phase-Phase L1-L2/L2-L3/L3-L1 – 2 wafers – scheme 67.				
<b>GX16 67 U</b>	16	□ 48	1	0.124
For 3 phase to phase voltage and 3 phase voltage readings 3 wafers – scheme 66.				
<b>GX16 66 U</b>	16	□ 48	1	0.152
For 1 phase voltage and 3 phase to phase voltage readings 3 wafers – scheme 60.				
<b>GX16 60 U</b>	16	□ 48	1	0.143
<b>AMMETER SWITCHES.</b>				
Direct L1-L2-L3 current readings – 5 wafers – scheme 97.				
<b>GX16 97 U</b>	16	□ 48	1	0.186
For L1-L2-L3 readings via 3 CTs – 4 wafers – scheme 98.				
<b>GX16 98 U</b>	16	□ 48	1	0.144

Type	UL/CSA general use [A]	UL/CSA horsepower ratings						Max IEC AC23 power [kW] at 400V
		1 phase		3 phases				
		120V	230V	200V	230V	480V	600V	
GX16	12	3/4	1	1 1/2	3	5	5	6.5
GX20	15	3/4	1 1/2	1 1/2	3	5	5	7.5
GX32	32	1 1/2	3	3	7 1/2	15	15	15
GX40	40	2	5	5	10	15	15	18.5

#### General characteristics

- IEC 16A conventional free air thermal current Ith ratings
- Conductivity: 10mA 5V
- Extended mechanical and electrical life
- Rotation angles: 30°, 45°, 60° and 90°
- Silver-alloy dual-breaking contacts
- Direct (positive) opening action ☹; safety function according to IEC/EN 60947-5-1
- IEC IP65 front degree of protection; IEC IP20 degree of protection of contacts
- Legend marking is standard supplied as illustrated in the order code table; any other on request.

#### Selection

See page 10-26.

#### Optional

Enlarged front plate for GX16-GX20 (65x65mm instead of standard 48x48): Add "H" after the switch rating in the order code E.g. GX16H 11 U.

Enlarged front plate for GX32-GX40 (90x90mm instead of standard 65x65): Add "H" after the switch rating in the order code E.g. GX32H 11 U.

#### Special versions

In addition to standard types, particular versions are available with special operating circuit schemes. See page 10-20.

#### Example of U version switch mounting

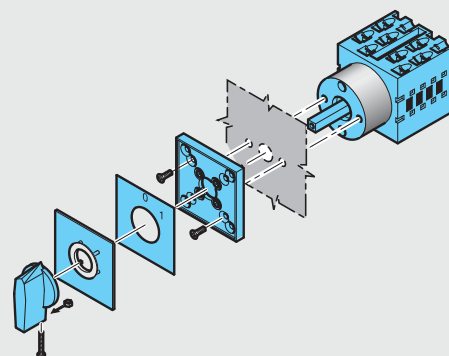

#### Certifications and compliance

Certifications obtained: EAC; UL Listed, for USA and Canada (File E155982) as Manual Motor Controllers. Compliant with standards: IEC/EN 60947-1, IEC/EN 60947-3, IEC/EN 60947-5-1, IEC/EN 61058-1, UL508, CSA C22.2 n°14.

Valid for motor, voltmeter and ammeter switches:

Front plate size:

48x48mm = 1.9x1.9"

65x65mm = 2.6x2.6"

90x90mm = 3.5x3.5"

### U11 version front ring mount with handle operation, for Ø22mm/Ø0.88" fixing. ON/OFF switches



Order code	IEC current AC1	Front plate size	Qty per pkg	Weight
	[A]	[mm]	n°	[kg]
ON/OFF SWITCHES. One-pole – 1 wafer – scheme 90.				
<b>GX16 90 U11</b>	16	—	1	0.100
Two-pole – 1 wafer – scheme 91.				
<b>GX16 91 U11</b>	16	—	1	0.100
Three-pole – 2 wafers – scheme 10.				
<b>GX16 10 U11</b>	16	—	1	0.120
Four-pole – 2 wafers – scheme 92.				
<b>GX16 92 U11</b>	16	—	1	0.123

#### General characteristics

- IEC 16...40A conventional free air thermal current Ith ratings
- Conductivity: 10mA 5V
- Extended mechanical and electrical life
- Rotation angles: 30°, 45°, 60° and 90°
- Silver-alloy dual-breaking contacts
- Direct (positive) opening action ⊖; safety function according to IEC/EN 60947-5-1
- IEC IP65 front degree of protection for U25 and U65, IEC IP40 for U11 and U12; IEC IP20 protection of contacts
- Legend marking for U11 and U12 versions is only for reference while for U25 and U65 types standard supplied as illustrated in the order code table; any other on request.

#### Selection

See page 10-26.

#### Optional

Enlarged front plate for GX16-GX20 (65x65mm instead of standard 48x48):  
Add "H" after the switch rating in the order code  
E.g. GX16H 10 U25.

Enlarged front plate for GX32-GX40 (90x90mm instead of standard 65x65):

Add "H" after the switch rating in the order code  
E.g. GX32H 10 U25.

#### Special versions

In addition to standard types, particular versions are available with special operating circuit schemes.  
See page 10-20.

#### Example of U25-U65 switch mounting

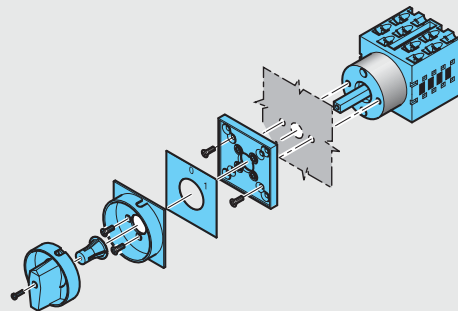

#### Certifications and compliance

Certifications obtained: EAC; UL Listed, for USA and Canada (File E155982) as Manual Motor Controllers. Compliant with standards: IEC/EN 60947-1, IEC/EN 60947-3, IEC/EN 60947-5-1, IEC/EN 61058-1, UL508, CSA C22.2 n°14.

Valid for U25-U65 versions:

Front plate size:  
48x48mm = 1.9x1.9"  
65x65mm = 2.6x2.6"  
90x90mm = 3.5x3.5".

### U12 version front ring mount with key operation, for Ø22mm/Ø0.88" fixing. ON/OFF switches



Order code	IEC current AC1	Front plate size	Qty per pkg	Weight
	[A]	[mm]	n°	[kg]
ON/OFF SWITCHES. One-pole – 1 wafer – scheme 90.				
<b>GX16 90 U12</b>	16	—	1	0.122
Two-pole – 1 wafer – scheme 91.				
<b>GX16 91 U12</b>	16	—	1	0.122
Three-pole – 2 wafers – scheme 10.				
<b>GX16 10 U12</b>	16	—	1	0.140
Four-pole – 2 wafers – scheme 92.				
<b>GX16 92 U12</b>	16	—	1	0.146

### U25-U65 versions front mount with red/yellow padlockable handle. ON/OFF switches



Order code	IEC current AC1	Front plate size	Qty per pkg	Weight
	[A]	[mm]	n°	[kg]
ON/OFF SWITCHES. Three-pole – 2 wafers – scheme 10.				
<b>GX16 10 U25</b>	16	□ 48	1	0.125
<b>GX20 10 U25</b>	20	□ 48	1	0.125
<b>GX32 10 U25</b>	32	□ 65	1	0.254
<b>GX40 10 U65</b>	40	□ 65	1	0.254
Four-pole – 2 wafers – scheme 92.				
<b>GX16 92 U25</b>	16	□ 48	1	0.130
<b>GX20 92 U25</b>	20	□ 48	1	0.130
<b>GX32 92 U25</b>	32	□ 65	1	0.266
<b>GX40 92 U65</b>	40	□ 65	1	0.266

Type	UL/CSA general use [A]	UL/CSA horsepower ratings						Max IEC AC23 power [kW] at 400V
		1 phase		3 phases				
		120V	230V	200V	230V	480V	600V	
GX16	12	3/4	1	1 1/2	3	5	5	6.5
GX20	15	3/4	1 1/2	1 1/2	3	5	5	7.5
GX32	32	1 1/2	3	3	7 1/2	15	15	15
GX40	40	2	5	5	10	15	15	18.5

### U47 version front snap on mount with handle operation, for Ø22mm/Ø0.88" fixing. ON/OFF switches



**new**

Order code	IEC current AC1 [A]	Front plate size [mm]	Qty per pkg n°	Weight [kg]
ON/OFF SWITCHES. One-pole – 1 wafer – scheme 90.				
<b>GX20 90 U47</b>	20	48	1	0.100
Two-pole – 1 wafer – scheme 91.				
<b>GX20 91 U47</b>	20	48	1	0.100
Three-pole – 2 wafers – scheme 10.				
<b>GX20 10 U47</b>	20	48	1	0.120
Four-pole – 2 wafers – scheme 92.				
<b>GX20 92 U47</b>	20	48	1	0.123

### U29D version front snap on mount with key operation, for Ø22mm/Ø0.88" fixing. ON/OFF switches



**new**

Order code	IEC current AC1 [A]	Front plate size [mm]	Qty per pkg n°	Weight [kg]
ON/OFF SWITCHES. One-pole – 1 wafer – scheme 90.				
<b>GX20 90 U29D</b>	20	48	1	0.122
Two-pole – 1 wafer – scheme 91.				
<b>GX20 91 U29D</b>	20	48	1	0.122
Three-pole – 2 wafers – scheme 10.				
<b>GX20 10 U29D</b>	20	48	1	0.140
Four-pole – 2 wafers – scheme 92.				
<b>GX20 92 U29D</b>	20	48	1	0.146

Type	UL/CSA general use [A]	UL/CSA horsepower ratings						Max IEC AC23 power [kW] at 400V
		1 phase		3 phases				
		120V	230V	200V	230V	480V	600V	
GX20	15	3/4	1 1/2	1 1/2	3	5	5	7.5

#### General characteristics

- IEC 20A conventional free air thermal current Ith ratings
- Conductivity: 10mA 5V
- Extended mechanical and electrical life
- Rotation angles: 30°, 45°, 60° and 90°
- Silver-alloy dual-breaking contacts
- Direct (positive) opening action ⊖; safety function according to IEC/EN 60947-5-1
- IEC IP65 front degree of protection; IEC IP20 protection of contacts.

#### Selection

See page 10-26.

#### Optional

Enlarged front plate for GX20 (65x65mm instead of standard 48x48):  
Add "H" after the switch rating in the order code  
E.g. GX20H 10 U47.

#### Special versions

In addition to standard types, particular versions are available with special operating circuit schemes.  
See page 10-20.

#### Example of U47 switch mounting

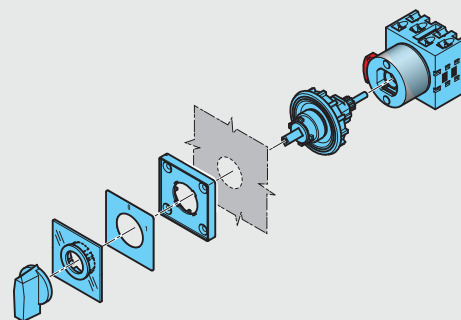

#### Certifications and compliance

Certifications obtained: EAC; UL Listed, for USA and Canada (File E155982) as Manual Motor Controllers.  
Compliant with standards: IEC/EN 60947-1, IEC/EN 60947-3, IEC/EN 60947-5-1, IEC/EN 61058-1, UL508, CSA C22.2 n°14.



**088 - 098 versions rear mount door coupling with red/yellow padlock system. ON/OFF switches**



Order code	IEC current AC1	Front plate size	Qty per pkg	Weight
	[A]	[mm]	n°	[kg]

ON/OFF SWITCHES.  
Three-pole – 2 wafers – scheme 10.

Order code	IEC current AC1	Front plate size	Qty per pkg	Weight
<b>GX16 10 088</b>	16	□ 48	1	0.178
<b>GX20 10 088</b>	20	□ 48	1	0.200
<b>GX32 10 088</b>	32	□ 65	1	0.320
<b>GX40 10 098</b>	40	□ 65	1	0.320



Four-pole – 2 wafers – scheme 92.

Order code	IEC current AC1	Front plate size	Qty per pkg	Weight
<b>GX16 92 088</b>	16	□ 48	1	0.182
<b>GX20 92 088</b>	20	□ 48	1	0.182
<b>GX32 92 088</b>	32	□ 65	1	0.320
<b>GX40 92 098</b>	40	□ 65	1	0.330



Type	UL/CSA general use [A]	UL/CSA horsepower ratings						Max IEC AC23 power [kW] at 400V
		1 phase		3 phases				
		120V	230V	200V	230V	480V	600V	
GX16	12	3/4	1	1 1/2	3	5	5	6.5
GX20	15	3/4	1 1/2	1 1/2	3	5	5	7.5
GX32	32	1 1/2	3	3	7 1/2	15	15	15
GX40	40	2	5	5	10	15	15	18.5

### General characteristics

- IEC 16...40A conventional free air thermal current Ith ratings
- Conductivity: 10mA 5V
- Extended mechanical and electrical life
- Rotation angles: 30°, 45°, 60° and 90°
- Silver-alloy dual-breaking contacts
- Direct (positive) opening action ⊖; safety function according to IEC/EN 60947-5-1
- IEC IP65 front degree of protection; IEC IP20 degree of protection of contacts
- Legend marking is standard supplied as illustrated in the order code table; any other on request.

### Selection

See page 10-26.

### Optional

Enlarged front plate for GX16-GX20 (65x65mm instead of standard 48x48):  
Add "H" after the switch rating in the order code  
E.g. GX16H 10 088.

Enlarged front plate for GX32-GX40 (90x90mm instead of standard 65x65):  
Add "H" after the switch rating in the order code  
E.g. GX32H 10 088.

### Special versions

In addition to standard types, particular versions are available with special operating circuit schemes.  
See page 10-20.

### Example of 0 version switch mounting

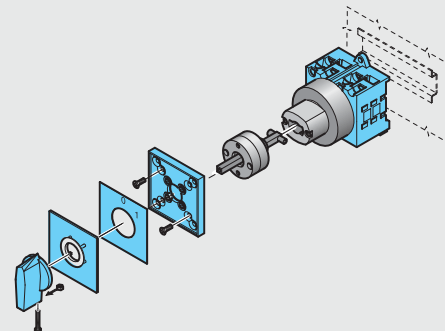

### Certifications and compliance

Certifications obtained: EAC; UL Listed, for USA and Canada (File E155982) as Manual Motor Controllers.  
Compliant with standards: IEC/EN 60947-1, IEC/EN 60947-3, IEC/EN 60947-5-1, IEC/EN 61058-1, UL508, CSA C22.2 n°14.

Valid for 088-098 versions:

Front plate size:  
48x48mm = 1.9x1.9"  
60x60mm = 2.6x2.6"  
90x90mm = 3.5x3.5".

**048 version**  
**modular service cover**  
**35mm DIN rail mount.**  
**ON/OFF switches.**  
**Changeover switches.**  
**Voltmeter switches.**  
**Ammeter switches**



Order code	IEC current AC1 [A]	Front plate size [mm]	Qty per pkg n°	Weight [kg]	
<b>ON/OFF SWITCHES.</b>					
One-pole – 3 wafers – scheme 90.					
<b>GX16 90 048</b>		16	45x54	1	0.110
Two-pole – 3 wafers – scheme 91.					
<b>GX16 91 048</b>		16	45x54	1	0.110
Three-pole – 3 wafers – scheme 10.					
<b>GX16 10 048</b>		16	45x54	1	0.118
Four-pole – 3 wafers – scheme 92.					
<b>GX16 92 048</b>		16	45x54	1	0.125
<b>CHANGEOVER SWITCHES WITH 0.</b>					
One-pole – 3 wafers – scheme 51.					
<b>GX16 51 048</b>		16	45x54	1	0.098
Two-pole – 3 wafers – scheme 52.					
<b>GX16 52 048</b>		16	45x54	1	0.122
Three-pole – 3 wafers – scheme 53.					
<b>GX16 53 048</b>		16	45x54	1	0.150
Four-pole – 4 wafers – scheme 75.					
<b>GX16 75 048</b>		16	45x54	1	0.170
<b>VOLTMETER SWITCHES.</b>					
Phase-Neutral L1-N/L2-N/L3-N – 3 wafers – scheme 68.					
<b>GX16 68 048</b>		16	45x54	1	0.130
Phase-Phase L1-L2/L2-L3/L3-L1 – 3 wafers – scheme 67.					
<b>GX16 67 048</b>		16	45x54	1	0.130
For 3 phase to phase voltage and 3 phase voltage readings 3 wafers – scheme 66					
<b>GX16 66 048</b>		16	45x54	1	0.156
<b>AMMETER SWITCHES.</b>					
Direct L1-L2-L3 current readings – 5 wafers – scheme 97.					
<b>GX16 97 048</b>		16	45x54	1	0.196
For L1-L2-L3 readings via 3 CTs – 4 wafers – scheme 98.					
<b>GX16 98 048</b>		16	45x54	1	0.150

Front cover size:  
45x54mm = 1.8x2.1"

Type	UL/CSA general use [A]	UL/CSA horsepower ratings						Max IEC AC23 power [kW] at 400V
		1 phase		3 phases				
		120V	230V	200V	230V	480V	600V	
GX16	12	3/4	1	1 1/2	3	5	5	6.5

### General characteristics

- IEC 16A conventional free air thermal current Ith ratings
- Conductivity: 10mA 5V
- Extended mechanical and electrical life
- Rotation angles: 30°, 45°, 60° and 90°
- Silver-alloy dual-breaking contacts
- Direct (positive) opening action ⊖; safety function according to IEC/EN 60947-5-1
- IEC IP40 front degree of protection; IEC IP20 degree of protection of contacts
- Suitable for screw fixing or mounting on 35mm DIN rail (IEC/EN 60175)
- Legend marking is standard supplied as illustrated in the order code table; any other on request.

### Selection guide

See page 10-26.

### Special versions

In addition to standard types, particular versions are available with special operating circuit schemes. See page 10-20.

### Certifications and compliance

Certifications obtained: EAC; UL Listed, for USA and Canada (File E155982) as Manual Motor Controllers. Compliant with standards: IEC/EN 60947-1, IEC/EN 60947-3, IEC/EN 60947-5-1, IEC/EN 61058-1, UL508, CSA C22.2 n°14.

### P version in enclosure with rotating handle. ON/OFF switches. Changeover switches



Order code	IEC current AC1	Housing size	Qty per pkg	Wt
	[A]	[mm]	n°	[kg]

ON/OFF SWITCHES.  
Three poles - scheme 10.

<b>GX16 10 P</b>	16	90x90	1	0.330
<b>GX20 10 P</b>	20	90x90	1	0.330
<b>GX32 10 P</b>	32	110x110	1	0.560
<b>GX40 10 P</b>	40	110x110	1	0.560



ON/OFF SWITCHES.  
Four poles - scheme 92.

<b>GX16 92 P</b>	16	90x90	1	0.340
<b>GX20 92 P</b>	20	90x90	1	0.340
<b>GX32 92 P</b>	32	110x110	1	0.575
<b>GX40 92 P</b>	40	110x110	1	0.575



CHANGEOVER SWITCHES.  
Three poles - scheme 53.

<b>GX16 53 P</b>	16	90x90	1	0.415
<b>GX20 53 P</b>	20	90x90	1	0.415
<b>GX32 53 P</b>	32	110x110	1	0.710
<b>GX40 53 P</b>	40	110x110	1	0.710



Four poles - scheme 75.

<b>GX16 75 P</b>	16	90x90	1	0.430
<b>GX20 75 P</b>	20	90x90	1	0.430
<b>GX32 75 P</b>	32	110x110	1	0.760
<b>GX40 75 P</b>	40	110x110	1	0.760



#### General characteristics

- IEC 16...40A conventional free air thermal current Ith ratings
- Conductivity: 10mA 5V
- Extended mechanical and electrical life
- Rotation angles: 30°, 45°, 60° and 90°
- Silver-alloy dual-breaking contacts
- Direct (positive) opening action ⊖; safety function according to IEC/EN 60947-5-1
- IP65 degree of protection
- Top and bottom entry: 4 PG16 threaded knockouts for 90x90mm types and 4 PG21 for 110x110mm
- Legend marking is standard supplied as illustrated in the order code table; any other on request.

#### Selection guide

See page 10-26.

#### Special versions

In addition to standard types, particular versions are available with special operating circuit schemes. See page 10-20.

#### Certifications and compliance

Certifications obtained: EAC.  
Compliant with standards: IEC/EN 60947-1, IEC/EN 60947-3, IEC/EN 60947-5-1, IEC/EN 61058-1.

Valid for P - P25 versions:

Housing size:  
90x90mm = 3.5x3.5"  
110x110mm = 4.3x4.3"

10

### P version in enclosure with rotating handle. Motor switches



Order code	Ith AC1 IEC	IEC power AC23A	Housing size	Qty per pkg	Wt.
	[A]	[A]	[mm]	n°	[kg]

MOTOR SWITCHES.  
Three-pole reversing switches - scheme 11.

<b>GX16 11 P</b>	16	5	90x90	1	0.405
<b>GX20 11 P</b>	20	7.5	90x90	1	0.425
<b>GX32 11 P</b>	32	15	110x110	1	0.695
<b>GX40 11 P</b>	40	15	110x110	1	0.700



### P25 version in enclosure with padlockable rotating handle. ON/OFF switches



Order code	IEC current AC1	Housing size	Qty per pkg	Wt
	[A]	[mm]	n°	[kg]

ON/OFF SWITCHES.  
Three poles - scheme 10.

<b>GX16 10 P25</b>	16	90x90	1	0.340
<b>GX20 10 P25</b>	20	90x90	1	0.345
<b>GX32 10 P25</b>	32	110x110	1	0.586



Four poles - scheme 92.

<b>GX16 92 P25</b>	16	90x90	1	0.350
<b>GX20 92 P25</b>	20	90x90	1	0.350
<b>GX32 92 P25</b>	32	110x110	1	0.605



For indication and reference purposes only - No UL/CSA approval

Type	UL/CSA general use [A]	UL/CSA horsepower ratings						Max IEC AC23 power [kW] at 400V
		1 phase		3 phases				
		120V	230V	200V	230V	480V	600V	
GX16	12	3/4	1	1 1/2	3	5	5	6.5
GX20	15	3/4	1 1/2	1 1/2	3	5	5	7.5
GX32	32	1 1/2	3	3	7 1/2	15	15	15
GX40	40	2	5	5	10	15	15	18.5

### Accessories for GX switches



7 A014 - 7 AR114 -  
7 A114 - 7 AR214



7 AR124 - 7 A124 - 7 AR224



7 APRBP



GX M1 - GX M2



GX M5 - GX M6



GX A01 - GX A01H - GX A11

Order code	Description	Q.ty per pkg	Weight
		n.	[kg]
<b>Black operating handle ①.</b>			
7 A014	For 48x48mm/1.9x1.9" front plate □ 6mm/0.24" for GX16-GX20	1	0.005
7 A114	For 65x65mm/2.6x2.6" front plate □ 7mm/0.28" for GX32-GX40 and GX16H-GX20H	1	0.010
7 AR214	For 90x90mm/3.5x3.4" front plate □ 7mm/0.28" for GX32H-GX40H	1	0.015
<b>Black operating lever ①.</b>			
7 A124	For 65x65mm/2.6x2.6" front plate □ 7mm/0.28" for GX32-GX40 and GX16H-GX20H	1	0.020
7 AR224	For 90x90mm/3.5x3.4" front plate □ 8mm/0.31" for GX32H-GX40H	1	0.038
<b>Adjustable door-coupling extension shaft. 70mm/2.8" long max ①.</b>			
7 APRBP	For GX16...GX40	1	0.027
<b>IP40 face plate ①.</b>			
GX M1	48x48mm/1.9x1.9" blank face plate	1	0.018
GX M2	65x65mm/2.6x2.6" blank face plate	1	0.023
<b>IP40 face plate with legend plate.</b>			
GX M5	48x60mm/1.9x2.6" blank face plate with legend plate	1	0.017
GX M6	65x80mm/2.6x3.1" blank face plate with legend plate	1	0.033
<b>Padlockable handle ①.</b>			
GX A01	48x48mm/1.9x1.9" red/yellow 0-1 padlockable handle for 2-position GX16-GX20	1	0.026
GX A01H	65x65mm/2.6x2.6" red/yellow 0-1 padlockable handle for 2-position GX16-GX20	1	0.047
GX A11	65x65mm/2.6x2.6" red/yellow 0-1 padlockable handle for 2-position GX32-GX40	1	0.047

① Also suitable for GN series.

### U version front mount. ON/OFF switches



Order code	IEC current AC1	Front plate size	Qty per pkg	Wt
	[A]	[mm]	n°	[kg]

ON/OFF SWITCHES.

One pole - 1 wafer - scheme 90.

7 GN12 90 U	16	□ 48	1	0.075
7 GN20 90 U	20	□ 48	1	0.077
7 GN25 90 U	25	□ 48	1	0.087
7 GN32 90 U	32	□ 65	1	0.173
7 GN40 90 U	40	□ 65	1	0.173
7 GN63 90 U	63	□ 65	1	0.200



2 poles - 1 wafer - scheme 91.

7 GN12 91 U	16	□ 48	1	0.079
7 GN20 91 U	20	□ 48	1	0.082
7 GN25 91 U	25	□ 48	1	0.094
7 GN32 91 U	32	□ 65	1	0.186
7 GN40 91 U	40	□ 65	1	0.186
7 GN63 91 U	63	□ 65	1	0.218



3 poles - 2 wafers - scheme 10.

7 GN12 10 U	16	□ 48	1	0.088
7 GN20 10 U	20	□ 48	1	0.095
7 GN25 10 U	25	□ 48	1	0.116
7 GN32 10 U	32	□ 65	1	0.228
7 GN40 10 U	40	□ 65	1	0.240
7 GN63 10 U	63	□ 65	1	0.282
7 GN125 10 U	125	□ 90	1	0.706



4 poles - 2 wafers - scheme 92.

7 GN12 92 U	16	□ 48	1	0.088
7 GN20 92 U	20	□ 48	1	0.098
7 GN25 92 U	25	□ 48	1	0.122
7 GN32 92 U	32	□ 65	1	0.232
7 GN40 92 U	40	□ 65	1	0.251
7 GN63 92 U	63	□ 65	1	0.302
7 GN125 92 U	125	□ 90	1	0.782



Front plate size:  
48x48mm = 1.9x1.9"  
65x65mm = 2.6x2.6"  
90x90mm = 3.5x3.5".

Type	UL/CSA general use [A]	UL/CSA horsepower ratings						Max IEC AC23 power [kW] at 400V
		1 phase		3 phases				
		120V	230V	200V	230V	480V	600V	
GN12	15	3/4	1	1 1/2	3	—	—	5.5
GN20	20	3/4	2	1 1/2	3	—	—	7.5
GN25	30	1 1/2	3	3	5	10	15	11
GN32	40	2	5	5	10	15	15	15
GN40	50	2	5	5	10	20	20	18.5
GN63	60	5	10	7 1/2	15	25	25	30
GN125	130	7 1/2	15	15	25	50	40	45

#### General characteristics

- IEC 16...125A conventional free air thermal current Ith ratings
- Conductivity: 10mA 5V
- Extended mechanical and electrical life
- Rotation angles: 30°, 45°, 60° and 90°
- Silver-alloy dual breaking contacts
- Direct (positive) opening action ⊖; safety function according to IEC/EN 60947-5-1
- IEC IP40 front degree of protection (for IP65 see Optional-front plate); IEC IP00 of contacts
- Legend marking is standard supplied as illustrated in the order code table; any other on request.

#### Selection guide

See page 10-26.

#### Optional

IEC IP65 front plate

Add "51" at the end of the order code.

E.g. 7 GN12 92 U 51.

Enlarged plate for GN12-20-25 (65x65mm instead of 48x48)

Add the letter "H" after the switch size of the order code.

E.g. 7 GN12H 10 U.

Enlarged plate for GN32-40-63 (90x90mm instead of 65x65)

Add the letter "H" after the switch size of the order code.

E.g. 7 GN32H 10 U.

#### Special versions

In addition to standard types, particular versions are available with special operating circuit schemes.

See page 10-20.

#### Certifications and compliance

Certifications obtained: EAC; CSA certified, for Canada and USA (File 207767) and UL Listed, for USA (File E155982), as Manual Motor Controllers. Compliant with standards: IEC/EN 60947-1, IEC/EN 60947-3, IEC/EN 60947-5-1, UL508, CSA C22.2 n°14.

### U version, front mount. Changeover switches with or without 0 (OFF)



Order code	IEC current AC1	Front plate size	Qty per pkg	Wt
	[A]	[mm]	n°	[kg]

CHANGEOVER SWITCH WITH 0 (OFF).

One-pole - 1 wafer - scheme 51.

7 GN12 51 U	16	□ 48	1	0.078
7 GN20 51 U	20	□ 48	1	0.081
7 GN25 51 U	25	□ 48	1	0.090
7 GN32 51 U	32	□ 65	1	0.183
7 GN40 51 U	40	□ 65	1	0.194
7 GN63 51 U	63	□ 65	1	0.224



Two-pole - 2 wafers - scheme 52.

7 GN12 52 U	16	□ 48	1	0.095
7 GN20 52 U	20	□ 48	1	0.098
7 GN25 52 U	25	□ 48	1	0.121
7 GN32 52 U	32	□ 65	1	0.232
7 GN40 52 U	40	□ 65	1	0.251
7 GN63 52 U	63	□ 65	1	0.302
7 GN125 52 U	125	□ 90	1	0.788



Three-pole - 3 wafers - scheme 53.

7 GN12 53 U	16	□ 48	1	0.107
7 GN20 53 U	20	□ 48	1	0.115
7 GN25 53 U	25	□ 48	1	0.152
7 GN32 53 U	32	□ 65	1	0.285
7 GN40 53 U	40	□ 65	1	0.308
7 GN63 53 U	63	□ 65	1	0.377
7 GN125 53 U	125	□ 90	1	1.036



Four-pole - 4 wafers - scheme 75.

7 GN12 75 U	16	□ 48	1	0.123
7 GN20 75 U	20	□ 48	1	0.134
7 GN25 75 U	25	□ 48	1	0.180
7 GN32 75 U	32	□ 65	1	0.334
7 GN40 75 U	40	□ 65	1	0.358
7 GN63 75 U	63	□ 65	1	0.468
7 GN125 75 U	125	□ 90	1	1.270



CHANGEOVER SWITCH WITHOUT 0 (OFF).

One-pole - 1 wafer - scheme 54.

7 GN12 54 U	16	□ 48	1	0.079
7 GN20 54 U	20	□ 48	1	0.082
7 GN25 54 U	25	□ 48	1	0.096



Two-pole - 2 wafers - scheme 55.

7 GN12 55 U	16	□ 48	1	0.093
7 GN20 55 U	20	□ 48	1	0.100
7 GN25 55 U	25	□ 48	1	0.122



Three-pole - 3 wafers - scheme 56.

7 GN12 56 U	16	□ 48	1	0.108
7 GN20 56 U	20	□ 48	1	0.115
7 GN25 56 U	25	□ 48	1	0.145



Four-pole - 4 wafers - scheme 69.

7 GN12 69 U	16	□ 48	1	0.124
7 GN20 69 U	20	□ 48	1	0.134
7 GN25 69 U	25	□ 48	1	0.174



Front plate size:  
48x48mm = 1.9x1.9" - 60x60mm = 2.6x2.6" - 90x90mm = 3.5x3.5".

Type	UL/CSA general use [A]	UL/CSA horsepower ratings						Max IEC AC23 power [kW] at 400V
		1 phase		3 phases				
		120V	230V	200V	230V	480V	600V	
GN12	15	3/4	1	1 1/2	3	—	—	5.5
GN20	20	3/4	2	1 1/2	3	—	—	7.5
GN25	30	1 1/2	3	3	5	10	15	11
GN32	40	2	5	5	10	15	15	15
GN40	50	2	5	5	10	20	20	18.5
GN63	60	5	10	7 1/2	15	25	25	30
GN125	130	7 1/2	15	15	25	50	40	45

#### General characteristics

- IEC 16...125A conventional free air thermal current Ith ratings
- Conductivity: 10mA 5V
- Extended mechanical and electrical life
- Rotation angles: 30°, 45°, 60° and 90°
- Silver-alloy dual breaking contacts
- Direct (positive) opening action ⊖; safety function according to IEC/EN 60947-5-1
- IEC IP40 front degree of protection (for IP65 see Optional-front plate); IEC IP00 of contacts
- Legend marking is standard supplied as illustrated in the order code table; any other on request.

#### Selection guide

See page 10-26.

#### Optional

IEC IP65 front plate  
Add "51" at the end of the order code.  
E.g. 7 GN12 52 U 51.

Enlarged plate for GN12-20-25 (65x65mm instead of 48x48)

Add the letter "H" after the switch size of the order code.  
E.g. 7 GN12H 51 U.

Enlarged plate for GN32-40-63 (90x90mm instead of 65x65)

Add the letter "H" after the switch size of the order code.  
E.g. 7 GN32H 51 U.

#### Special versions

In addition to standard types, particular versions are available with special operating circuit schemes.  
See page 10-20.

#### Certifications and compliance

Certifications obtained: EAC; CSA certified, for Canada and USA (File 207767) and UL Listed, for USA (File E155982), as Manual Motor Controllers. Compliant with standards: IEC/EN 60947-1, IEC/EN 60947-3, IEC/EN 60947-5-1, UL508, CSA C22.2 n°14.

### U version front mount. Motor switches



Order code	Ith AC1 IEC	IEC power AC23A	Front plate size	Qty per pkg	Wt
	[A]	[kW]	[mm]	n°	[kg]

#### MOTOR SWITCHES.

Three-pole reversing switches - 3 wafers - scheme 11.

7 GN12 11 U	16	6	□ 48	1	0.105
7 GN20 11 U	20	7.5	□ 48	1	0.111
7 GN25 11 U	25	11	□ 48	1	0.145
7 GN32 11 U	32	15	□ 65	1	0.278
7 GN40 11 U	40	18.5	□ 65	1	0.294
7 GN63 11 U	63	30	□ 65	1	0.366
7 GN125 11 U	125	45	□ 90	1	0.976



Pole changing switches - 4 wafers - scheme 13.

7 GN12 13 U	16	6	□ 48	1	0.126
7 GN20 13 U	20	7.5	□ 48	1	0.134
7 GN25 13 U	25	11	□ 48	1	0.181
7 GN32 13 U	32	15	□ 65	1	0.342
7 GN40 13 U	40	18.5	□ 65	1	0.366
7 GN63 13 U	63	30	□ 65	1	0.465
7 GN125 13 U	125	45	□ 90	1	1.301



Star-delta switches - 4 wafers - scheme 12.

7 GN12 12 U	16	6	□ 48	1	0.124
7 GN20 12 U	20	7.5	□ 48	1	0.134
7 GN25 12 U	25	11	□ 48	1	0.175
7 GN32 12 U	32	15	□ 65	1	0.343
7 GN40 12 U	40	18.5	□ 65	1	0.366
7 GN63 12 U	63	30	□ 65	1	0.465
7 GN125 12 U	125	45	□ 90	1	1.303



Three-pole reversing switches with spring return to 0 - 3 wafers - scheme 26.

7 GN12 26 U	16	6	□ 48	1	0.106
7 GN20 26 U	20	7.5	□ 48	1	0.111
7 GN25 26 U	25	11	□ 48	1	0.144



Pole changing switches with reversing (Dahlander) - 6 wafers - scheme 20.

7 GN12 20 U	16	6	□ 48	1	0.161
7 GN20 20 U	20	7.5	□ 48	1	0.165
7 GN25 20 U	25	11	□ 48	1	0.246



Front plate size:  
48x48mm = 1.9x1.9"  
65x65mm = 2.6x2.6"  
90x90mm = 3.5x3.5"

Type	UL/CSA general use [A]	UL/CSA horsepower ratings						Max IEC AC23 power [kW] at 400V
		1 phase		3 phases				
		120V	230V	200V	230V	480V	600V	
GN12	15	3/4	1	1 1/2	3	—	—	5.5
GN20	20	3/4	2	1 1/2	3	—	—	7.5
GN25	30	1 1/2	3	3	5	10	15	11
GN32	40	2	5	5	10	15	15	15
GN40	50	2	5	5	10	20	20	18.5
GN63	60	5	10	7 1/2	15	25	25	30
GN125	130	7 1/2	15	15	25	50	40	45

#### General characteristics

- IEC 16...125A conventional free air thermal current Ith ratings
- Conductivity: 10mA 5V
- Extended mechanical and electrical life
- Rotation angles: 30°, 45°, 60° and 90°
- Silver-alloy dual breaking contacts
- Direct (positive) opening action ⊖; safety function according to IEC/EN 60947-5-1
- IEC IP40 front degree of protection (for IP65 see Optional-front plate); IEC IP00 of contacts
- Legend marking is standard supplied as illustrated in the order code table; any other on request.

#### Selection guide

See page 10-26.

#### Optional

IEC IP65 front plate  
Add "51" at the end of the order code.  
E.g. 7 GN12 13 U 51.

Enlarged plate for GN12-20-25 (65x65mm instead of 48x48)  
Add the letter "H" after the switch size of the order code.  
E.g. 7 GN12H 11 U.

Enlarged plate for GN32-40-63 (90x90mm instead of 65x65)  
Add the letter "H" after the switch size of the order code.  
E.g. 7 GN32H 11 U.

#### Special versions

In addition to standard types, particular versions are available with special operating circuit schemes.  
See page 10-20.

#### Certifications and compliance

Certifications obtained: EAC; CSA certified, for Canada and USA (File 207767) and UL Listed, for USA (File E155982), as Manual Motor Controllers. Compliant with standards: IEC/EN 60947-1, IEC/EN 60947-3, IEC/EN 60947-5-1, UL508, CSA C22.2 n°14.

### U version, front mount. Voltmeter switches. Ammeter switches



Order code	IEC current AC1	Front plate size	Qty per pkg	Wt
	[A]	[mm]	n°	[kg]

**VOLTMETER SWITCHES.**  
Phase-Neutral L1-N/L2-N/L3-N  
2 wafers - scheme 68.

<b>7 GN12 68 U</b>		16	□ 48	1	0.094
<b>7 GN20 68 U</b>		20	□ 48	1	0.099

Phase-Phase L1-L2/L2-L3/L3-L1  
2 wafers - scheme 67.

<b>7 GN12 67 U</b>		16	□ 48	1	0.094
<b>7 GN20 67 U</b>		20	□ 48	1	0.099

For 3 phase to phase voltages and 3 phase voltages  
3 wafers - scheme 66.

<b>7 GN12 66 U</b>		16	□ 48	1	0.116
<b>7 GN20 66 U</b>		20	□ 48	1	0.116

For 1 phase voltage and 3 phase to phase voltages  
3 wafers - scheme 60.

<b>7 GN12 60 U</b>		16	□ 48	1	0.105
<b>7 GN20 60 U</b>		20	□ 48	1	0.120

**AMMETER SWITCHES.**  
Direct L1-L2-L3 reading - 5 wafers - scheme 97.

<b>7 GN12 97 U</b>		16	□ 48	1	0.132
<b>7 GN20 97 U</b>		20	□ 48	1	0.148

L1-L2-L3 reading via 3 current transformers  
4 wafers - scheme 98.

<b>7 GN12 98 U</b>		16	□ 48	1	0.115
<b>7 GN20 98 U</b>		20	□ 48	1	0.115

Front plate size:  
48x48mm = 1.9x1.9"  
65x65mm = 2.6x2.6".

Type	UL/CSA general use [A]	UL/CSA horsepower ratings						Max IEC AC23 power [kW] at 400V
		1 phase		3 phases				
		120V	230V	200V	230V	480V	600V	
GN12	15	3/4	1	1 1/2	3	—	—	5.5
GN20	20	3/4	2	1 1/2	3	—	—	7.5

#### General characteristics

- IEC 16...20A conventional free air thermal current Ith ratings
- Conductivity: 10mA 5V
- Extended mechanical and electrical life
- Rotation angles: 30°, 45°, 60° and 90°
- Silver-alloy dual breaking contacts
- Direct (positive) opening action ⊖; safety function according to IEC/EN 60947-5-1
- IEC IP40 front degree of protection (for IP65 see Optional-front plate); IEC IP00 of contacts
- Legend marking is standard supplied as illustrated in the order code table; any other on request.

#### Selection guide

See page 10-26.

#### Optional

IEC IP65 front plate  
Add "51" at the end of the order code.  
E.g. 7 GN12 67 U 51.

Enlarged plate for GN12-20-25 (65x65mm instead of 48x48)

Add the letter "H" after the switch size of the order code.  
E.g. 7 GN12H 68 U.

#### Special versions

In addition to standard types, particular versions are available with special operating circuit schemes.  
See page 10-20.

#### Certifications and compliance

Certifications obtained: EAC; CSA certified, for Canada and USA (File 207767) and UL Listed, for USA (File E155982), as Manual Motor Controllers. Compliant with standards: IEC/EN 60947-1, IEC/EN 60947-3, IEC/EN 60947-5-1, UL508, CSA C22.2 n°14.



### U11 version front ring mount with handle operation for Ø22mm/Ø0.88" fixing. ON/OFF switches



Order code	IEC current AC1 [A]	Front plate size [mm]	Qty per pkg n°	Wt [kg]
ON/OFF SWITCHES. One-pole - 1 wafer - scheme 90.				
7 GN12 90 U11	16	—	1	0.078
7 GN20 90 U11	20	—	1	0.082
Two-pole - 1 wafer - scheme 91.				
7 GN12 91 U11	16	—	1	0.080
7 GN20 91 U11	20	—	1	0.084
Three-pole - 2 wafers - scheme 10.				
7 GN12 10 U11	16	—	1	0.092
7 GN20 10 U11	20	—	1	0.095
Four-pole - 2 wafers - scheme 92.				
7 GN12 92 U11	16	—	1	0.094
7 GN20 92 U11	20	—	1	0.100

### U12 version front ring mount with key operation for Ø22mm/Ø0.88" fixing. ON/OFF switches



Order code	IEC current AC1 [A]	Front plate size [mm]	Qty per pkg n°	Wt [kg]
ON/OFF SWITCHES. One-pole - 1 wafer - scheme 90.				
7 GN12 90 U12	16	—	1	0.100
7 GN20 90 U12	20	—	1	0.104
Two-pole - 1 wafer scheme 91.				
7 GN12 91 U12	16	—	1	0.108
7 GN20 91 U12	20	—	1	0.112
Three-pole - 2 wafers - scheme 10.				
7 GN12 10 U12	16	—	1	0.129
7 GN20 10 U12	20	—	1	0.135
Four-pole - 2 wafers - scheme 92.				
7 GN12 92 U12	16	—	1	0.132
7 GN20 92 U12	20	—	1	0.139

### U25-U65 version front ring mount with red/yellow padlockable handle. ON/OFF switches



Order code	IEC current AC1 [A]	Front plate size [mm]	Qty per pkg n°	Wt [kg]
ON/OFF SWITCHES. Three-pole - 2 wafers - scheme 10.				
7 GN12 10 U25	16	□ 65	1	0.161
7 GN20 10 U25	20	□ 65	1	0.165
7 GN25 10 U25	25	□ 65	1	0.187
7 GN32 10 U25	32	□ 65	1	0.277
7 GN40 10 U65	40	□ 65	1	0.294
7 GN63 10 U65	63	□ 65	1	0.366
7 GN125 10 U65	125	□ 90	1	0.976
Four-pole - 2 wafers - scheme 92.				
7 GN12 92 U25	16	□ 65	1	0.164
7 GN20 92 U25	20	□ 65	1	0.169
7 GN25 92 U25	25	□ 65	1	0.196
7 GN32 92 U25	32	□ 65	1	0.285
7 GN40 92 U65	40	□ 65	1	0.298
7 GN63 92 U65	63	□ 65	1	0.370
7 GN125 92 U65	125	□ 90	1	0.984

#### General characteristics

- IEC 16...125A conventional free air thermal current Ith ratings
- Conductivity: 10mA 5V
- Extended mechanical and electrical life
- Rotation angles: 30°, 45°, 60° and 90°
- Silver-alloy dual breaking contacts
- Direct (positive) opening action ⊖; safety function according to IEC/EN 60947-5-1
- IEC IP40 front degree of protection (for IP65 see Optional-front plate); IEC IP00 of contacts for U11 and U12 and IEC IP20 of incoming contacts for U25 and U65 only
- Legend marking for U11 and U12 versions is only for reference while for U25 and U65 types standard supplied as illustrated in the order code table; any other on request.

#### Selection guide

See page 10-26.

#### Optional

IEC IP65 front plate  
Add "51" at the end of the order code.  
E.g. 7 GN12 92 U25 51.

Enlarged plate for GN32-40-63 (90x90mm instead of 65x65)  
Add the letter "H" after the switch size of the order code.  
E.g. 7 GN32H 10 U25.

#### Special versions

In addition to standard types, particular versions are available with special operating circuit schemes.  
See page 10-20.

#### Certifications and compliance

Certifications obtained: EAC; CSA certified, for Canada and USA (File 207767) and UL Listed, for USA (File E155982), as Manual Motor Controllers. Compliant with standards: IEC/EN 60947-1, IEC/EN 60947-3, IEC/EN 60947-5-1, UL508, CSA C22.2 n°14.

Valid for U25 - U65 versions:

Front plate size:  
65x65mm = 2.6x2.6"  
90x90mm = 3.5x3.5".

For UL/CSA ratings, see page 10-15.

**088-098-099 version**  
**rear mount**  
**door coupling with**  
**red/yellow padlock system.**  
**ON/OFF switches**



Order code	IEC current AC1 [A]	Front plate size [mm]	Qty per pkg n°	Wt [kg]
------------	---------------------	-----------------------	----------------	---------

ON/OFF SWITCHES.  
 Three-pole - 2 wafers - scheme 10.

7 GN12 10 088	16	□ 65	1	0.223
7 GN20 10 088	20	□ 65	1	0.226
7 GN25 10 088	25	□ 65	1	0.252
7 GN32 10 088	32	□ 65	1	0.326
7 GN40 10 098	40	□ 65	1	0.329
7 GN63 10 098	63	□ 65	1	0.374
7 GN125 10 099	125	□ 90	1	0.909



Four-pole - 2 wafers - scheme 92.

7 GN12 92 088	16	□ 65	1	0.223
7 GN20 92 088	20	□ 65	1	0.233
7 GN25 92 088	25	□ 65	1	0.259
7 GN32 92 088	32	□ 65	1	0.327
7 GN40 92 098	40	□ 65	1	0.341
7 GN63 92 098	63	□ 65	1	0.391
7 GN125 92 099	125	□ 90	1	0.985



Type	UL/CSA general use [A]	UL/CSA horsepower ratings						Max IEC AC23 power [kW] at 400V
		1 phase		3 phases				
		120V	230V	200V	230V	480V	600V	
GN12	15	3/4	1	1 1/2	3	—	—	5.5
GN20	20	3/4	2	1 1/2	3	—	—	7.5
GN25	30	1 1/2	3	3	5	10	15	11
GN32	40	2	5	5	10	15	15	15
GN40	50	2	5	5	10	20	20	18.5
GN63	60	5	10	7 1/2	15	25	25	30
GN125	130	7 1/2	15	15	25	50	40	45

### General characteristics

- IEC 16...125A conventional free air thermal current Ith ratings
- Conductivity: 10mA 5V
- Extended mechanical and electrical life
- Rotation angles: 30°, 45°, 60° and 90°
- Silver-alloy dual breaking contacts
- Direct (positive) opening action ⊖; safety function according to IEC/EN 60947-5-1
- IEC IP40 front degree of protection (for IP65 see Optional-front plate); IEC IP20 of incoming contacts only
- Legend marking is standard supplied as illustrated in the order code table; any other on request.

### Selection guide

See page 10-26.

### Optional

IEC IP65 front plate  
 Add "51" at the end of the order code.  
 E.g. 7 GN12 92 088 51.

Fixing plate for DIN 35mm rail (IEC/EN 60715)  
 Add "18" at the end of the order code.  
 E.g. 7 GN25 10 0 18.

Enlarged plate for GN12-20-25 (65x65mm instead of 48x48)  
 Add the letter "H" after the switch size of the order code.  
 E.g. 7 GN12H 10 088.

Enlarged plate for GN32-40-63 (90x90mm instead of 65x65)  
 Add the letter "H" after the switch size of the order code.  
 E.g. 7 GN32H 10 088.

### Special versions

In addition to standard types, particular versions are available with special operating circuit schemes.  
 See page 10-20.

### Certifications and compliance

Certifications obtained: EAC; CSA certified, for Canada and USA (File 207767) and UL Listed, for USA (File E155982), as Manual Motor Controllers. Compliant with standards: IEC/EN 60947-1, IEC/EN 60947-3, IEC/EN 60947-5-1, UL508, CSA C22.2 n°14.

Valid for 088 - 098 - 099 - versions:

Front plate size:  
 48x48mm = 1.9x1.9"  
 65x65mm = 2.6x2.6"  
 90x90mm = 3.5x3.5".

### P version in enclosure with rotating handle. ON/OFF switches. Changeover switches



Order code	IEC current AC1	Housing size	Qty per pkg	Wt
	[A]	[mm]	n°	[kg]

ON/OFF SWITCHES.  
Three-pole - scheme 10.

7 GN12 10 P	16	75x75	1	0.168
7 GN20 10 P	20	75x75	1	0.227
7 GN25 10 P	25	75x75	1	0.258
7 GN32 10 P	32	90x90	1	0.392
7 GN40 10 P	40	110x110	1	0.453
7 GN63 10 P	63	110x110	1	0.766



Four-pole - scheme 92.

7 GN12 92 P	16	75x75	1	0.174
7 GN20 92 P	20	75x75	1	0.222
7 GN25 92 P	25	75x75	1	0.278
7 GN32 92 P	32	90x90	1	0.411
7 GN40 92 P	40	110x110	1	0.411
7 GN63 92 P	63	110x110	1	0.625



CHANGEOVER SWITCHES.  
Three-pole - scheme 53.

7 GN12 53 P	16	75x75	1	0.219
7 GN20 53 P	20	75x75	1	0.273
7 GN25 53 P	25	75x75	1	0.307
7 GN32 53 P	32	90x90	1	0.500
7 GN40 53 P	40	110x110	1	0.727
7 GN63 53 P	63	110x110	1	0.785



Four-pole - scheme 75.

7 GN12 75 P	16	75x75	1	0.226
7 GN20 75 P	20	75x75	1	0.289
7 GN25 75 P	25	90x90	1	0.418
7 GN32 75 P	32	90x90	1	0.540
7 GN40 75 P	40	110x110	1	0.753
7 GN63 75 P	63	110x110	1	0.840



### P version in enclosure with rotating handle. Motor switches



Order code	IEC current AC1	IEC power AC23A	Housing size	Qty per pkg	Wt
	[A]	[kW]	[mm]	n°	[kg]

MOTOR SWITCHES.  
Three-pole reversing switches - scheme 11.

7 GN12 11 P	16	5.5	75x75	1	0.216
7 GN20 11 P	20	7.5	75x75	1	0.271
7 GN25 11 P	25	11	75x75	1	0.299
7 GN32 11 P	32	15	90x90	1	0.482
7 GN40 11 P	40	18.5	110x110	1	0.508
7 GN63 11 P	63	30	110x110	1	0.750



### P25 version in enclosure with padlockable rotating handle. ON/OFF switches



Order code	IEC current AC1	Housing size	Qty per pkg	Wt
	[A]	[mm]	n°	[kg]

ON/OFF SWITCHES.  
Three-pole - scheme 10.

7 GN20 10 P25	20	90x90	1	0.313
7 GN25 10 P25	25	90x90	1	0.327
7 GN32 10 P25	32	90x90	1	0.400



Four poles - scheme 92.

7 GN20 92 P25	20	90x90	1	0.314
7 GN25 92 P25	25	90x90	1	0.339
7 GN32 92 P25	32	90x90	1	0.425



### General characteristics

- IEC 16...63A conventional free air thermal current Ith ratings
- Conductivity: 10mA 5V
- Extended mechanical and electrical life
- Rotation angles: 30°, 45°, 60° and 90°
- Silver-alloy dual breaking contacts
- Direct (positive) opening action ⊖; safety function according to IEC/EN 60947-5-1
- IP65 degree of protection
- Top and bottom entry:
  - 4 PG13.5 threaded knockouts for 75x75mm types
  - 4 PG16 threaded knockouts for 90x90mm types
  - 4 PG21 threaded knockouts for 110x110mm types
- Legend marking is standard supplied as illustrated in the order code table; any other on request.

### Selection guide

See page 10-26.

### Special versions

In addition to standard types, particular versions are available with special operating circuit schemes. See page 10-20.

### Certifications and compliance

Certifications obtained: EAC.  
Compliant with standards: IEC/EN 60947-1, IEC/EN 60947-3, IEC/EN 60947-5-1.

Valid for P - P25 versions:

Housing size:  
75x75mm = 3x3"  
90x90mm = 3.5x3.5"  
110x110mm = 4.3x4.3"

For indication and reference purposes only  
No UL/CSA approval

Type	UL/CSA general use [A]	Max IEC AC23 power [kW] at 400V
GN12	15	5.5
GN20	20	7.5
GN25	30	11
GN32	40	15
GN40	50	18.5
GN63	60	30

Type	UL/CSA horsepower ratings					
	1 phase		3 phases			
	120V	230V	200V	230V	480V	600V
GN12	3/4	1	1 1/2	3	—	—
GN20	3/4	2	1 1/2	3	—	—
GN25	1 1/2	3	3	5	10	15
GN32	2	5	5	10	15	15
GN40	2	5	5	10	20	20
GN63	5	10	7 1/2	15	25	25

### Accessories for GN switches



7 A019... -  
7 A119...



7 A169...



7 A014 -  
7 AR114 -  
7 A114 -  
7 AR214



7 AR124 -  
7 A124 -  
7 AR224



7 A180 - 7 A181



7 APRBP



7 A441 - 7 A442 - 7 A443



GX M1 - GX M2



GX A01 - GX A01H - GX A11

Order code	Description	Qty per pkg	Wt
		n°	[kg]

IEC IP20 finger protection shroud for supply terminals.  
For 2 wafers complete with screws and bracket.

7 A0191	For GN12-GN20	1	0.017
7 A0192	For GN25	1	0.021
7 A119U	For GN32 U version	1	0.033
7 A119O	For GN32 O version	1	0.101

2-piece kit, snap-on fixing for 1 wafer.

7 A1691	For GN40	1	0.005
7 A1692	For GN63	1	0.006
7 A1693	For GN125	1	0.020
7 A1694	For GN12-GN20	1	0.005
7 A1695	For GN25	1	0.005

Black operating handle①.

7 A014②	For 48x48mm front plate □ 6mm/0.24" for GN12-GN20-GN25	1	0.005
7 AR114	For 65x65mm front plate □ 6mm/0.24" for GN12H-GN20H-GN25H	1	0.010
7 A114②	For 65x65mm front plate □ 6mm/0.24" for GN32-GN40-GN63	1	0.010
7 AR214②	For 90x90mm front plate □ 7mm/0.28" for GN125 and GN32H-GN40H-GN63H	1	0.013

Black operating lever①.

7 AR214②	For 65x65mm front plate □ 6mm/0.24" for GN12H-GN20H-GN25H	1	0.019
7 A124	For 65x65mm front plate □ 7mm/0.28" for GN32-GN40-GN63	1	0.020
7 AR224②	For 90x90mm front plate □ 8mm/0.31" for GN125 and GN32H-GN40H-GN63H	1	0.038

35mm DIN rail (IEC/EN 60715) base mounting piece for U version.

7 A180	For GN12...GN25	1	0.011
7 A181	For GN32...GN63	1	0.018

Adjustable door-coupling extension shaft, 70mm/2.8" long max①.

7 APRBP	For GN12...GN63	1	0.027
---------	-----------------	---	-------

Flexible rubber shroud②.

7 A441	Ø 58mm/2.3", 70mm/2.8" long for GN12 to GN25 with 2 elements	1	0.045
7 A442	Ø 58mm/2.3", 92mm/3.6" long for GN12 to GN25 with 4 elements	1	0.065
7 A443	Ø 58mm/2.3", 125mm/4.9" long for GN12 to GN25 with 6 elements	1	0.063

IP40 face plate①.

GX M1	48x48mm blank face plate	1	0.018
GX M2	65x65mm blank face plate	1	0.023

Padlockable handle①.

GX A01	48x48mm red/yellow 0-1 padlockable handle for 2-position GN12-GN20-GN25	1	0.026
GX A01H	65x65mm red/yellow 0-1 padlockable handle for 2-position GN12-GN20-GN25	1	0.047
GX A11	65x65mm red/yellow 0-1 padlockable handle for 2-position GN32-GN40-GN63	1	0.047

Front plate size:  
48x48mm = 1.9x1.9"  
65x65mm = 2.6x2.6"  
90x90mm = 3.5x3.5".

① Suitable for GN... types with IEC IP40 (standard supply). For GN...51 types, consult Customer Service for information; see contact details on inside front cover.

② Raises contact degree of protection from IEC IP00...IP20.

③ Also suitable for GX series.

### Order code structure

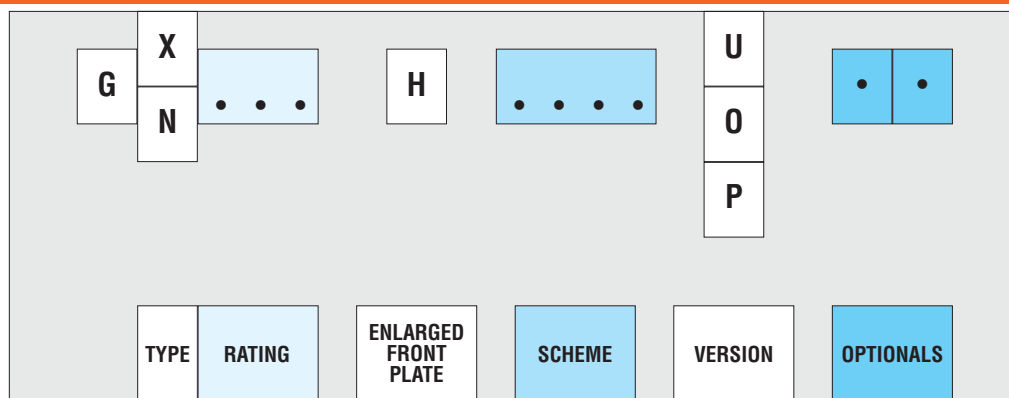

**GX**  
IEC Protection:  
Front = IP65  
Contacts = IP20

**GN**  
IEC Protection :  
Front = IP40  
Contacts = IP00

GX	GN
16A	16A
20A	20A
32A	25A
40A	32A
	40A
	63A
	125A

e.g.  
90  
91  
10  
92  
99  
100

**U** = Front mount  
**O** = Rear mount  
**P** = In enclosure

10

Insert H when an enlarged front plate is required

**GX16 - GX20**  
**GN12 - GN20 - GN25**  
from 48x48mm to 65x65mm

**GX32 - GX40**  
**GN32 - GN40 - GN63**  
from 65x65mm to 90x90mm

Front plate size:  
48x48mm = 1.9x1.9in  
65x65mm = 2.6x2.6in  
90x90mm = 3.5x3.5in.

11	Front mount, with handle operation, for Ø22mm fixing
12	Front mount, with key operation, for Ø22mm fixing
18	35mm DIN rail mounting (IEC/EN 60715)
25	Red-yellow padlockable handle
47	Front mount, with handle operation, for snap on Ø22mm fixing (up to GX20 and GN25)
29D	Front mount, with key operation, for snap on Ø22mm fixing (up to GX20 and GN25)
48	Modular service cover, 35mm DIN rail mounting
4V	Front mount, with 4-screw fixing
51	IP65 front protection, for GN only
65	Red-yellow padlockable handle
88	Door coupling, with red-yellow padlockable handle (up to GX32, GN32)
98	Door coupling, with red-yellow padlockable handle (for GX40, GN40, GN63)
99	Door coupling, with red-yellow padlockable handle (for GN125)

Consult technical instructions I230 on our website for additional information (contact configurations, schemes, plate indications, etc).  
Custom-built schemes are available on request; fill out the form on page 10-21.

Example for ordering:

**GX16 53 P** = Changeover switch, 16A, 3 poles, 3 positions, 3 wafers in 90x90mm, IEC IP65 enclosure.

**GN25 H 90 U 51** = On-Off switch, 25A, 1 pole, 2 positions, 1 wafer, with enlarged 65x65mm front plate and IEC IP65 protection, 2-screw fixing.

1	4	5	8	9	12	13	16	17	20	21	24	25	28	29	32	33	36	37	40	41	44	45	48
2	3	6	7	10	11	14	15	18	19	22	23	26	27	30	31	34	35	38	39	42	43	46	47

Plate indication	Pos.																								
	7																								
C	8																								
	9																								
D	10																								
	11																								
	12																								
A	1																								
	2																								
	3																								
B	4																								
	5																								
	6																								

**Front plate**

1		X		X		X	
2		X		X		X	X
		<b>Overlapping contacts</b>		<b>Closed contact in 2 or more positions</b>		<b>Open/passing contact</b>	<b>Closed contact</b>
							<b>Spring return</b>

BODY SHAPE:  Square - GX ❶  Round - GN Amp rating .....

VERSION:  Front mount  Rear mount  Enclosed  Other .....

FINISH:  Standard ❷  Red/yellow padlockable  Special .....

FIXING:  2 screw  4 screw  Snap

Q.ty:..... Company name and contact details: .....

❶ Maximum 40A ratings for GX series.  
 ❷ Standard supplied finish is grey front plate while 0-12 indication and the handle are black; any other is considered special.  
**Also consult technical instructions I230 on the website.**

### GX SERIES

#### Front mount

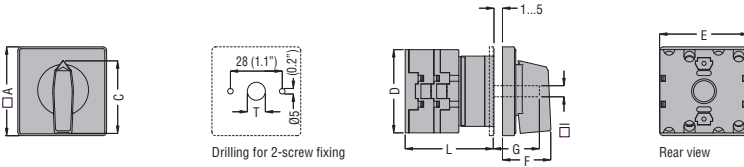

Type	Dimensions							L [mm (in)]						
	A	C	D	E	F	G	I	T	1 wafer	2 wafers	3 wafers	4 wafers	5 wafers	6 wafers
<b>GX16 U</b>	48 (1.89")	39.5 (1.55")	45 (1.77")	48 (1.89")	26.5 (1.04")	23.5 (0.92")	6 (0.24")	12 (0.47")	42.5 (1.67")	51 (2.00")	59.5 (2.34")	68 (2.67")	76.5 (3.01")	85 (3.35")
<b>GX16 U25</b>	48 (1.89")	31 $\phi$ (1.22")	45 (1.77")	48 (1.89")	34 (1.33")	23.5 (0.92")	26 (0.24")	12 (0.47")	39.5 (1.55")	48 (1.89")	56.5 (2.22")	65 (2.55")	73.5 (2.89")	82 (3.22")
<b>GX20 U</b>	48 (1.89")	39.5 (1.55")	45 (1.77")	48 (1.89")	26.5 (1.04")	23.5 (0.92")	6 (0.24")	12 (0.47")	42.5 (1.67")	51 (2.00")	59.5 (2.34")	68 (2.67")	76.5 (3.01")	85 (3.35")
<b>GX20 U25</b>	48 (1.89")	31 $\phi$ (1.22")	45 (1.77")	48 (1.89")	34 (1.33")	23.5 (0.92")	6 (0.24")	12 (0.47")	39.5 (1.55")	48 (1.89")	56.5 (2.22")	65 (2.55")	73.5 (2.89")	82 (3.22")
<b>GX32 U</b>	65 (2.56")	53 (2.09")	58 (2.28")	66 (2.59")	34.5 (1.36")	26 (1.02")	7 (0.27")	14 (0.55")	47.5 (1.87")	59.5 (2.34")	71.5 (2.81")	83.5 (3.29")	95.5 (3.75")	107.5 (4.23")
<b>GX32 U25</b>	65 (2.56")	45 $\phi$ (1.77")	58 (2.28")	66 (2.59")	38 (1.50")	26 (1.02")	7 (0.27")	14 (0.55")	48 (1.89")	60 (2.36")	72 (2.83")	84 (3.30")	96 (3.77")	108 (4.25")
<b>GX40 U</b>	65 (2.56")	53 (2.09")	58 (2.28")	66 (2.59")	34.5 (1.36")	26 (1.02")	7 (0.27")	14 (0.55")	47.5 (1.87")	59.5 (2.34")	71.5 (2.81")	83.5 (3.29")	95.5 (3.75")	107.5 (4.23")
<b>GX40 U25</b>	65 (2.56")	45 $\phi$ (1.77")	58 (2.28")	66 (2.59")	38 (1.50")	26 (1.02")	7 (0.27")	14 (0.55")	48 (1.89")	60 (2.36")	72 (2.83")	84 (3.30")	96 (3.77")	108 (4.25")

$\phi$  Padlockable handle.

#### Door coupling O version

#### Coupling and front plate fixing on the door

#### Drilling for 4-screw (4V suffix types) front plate fixing

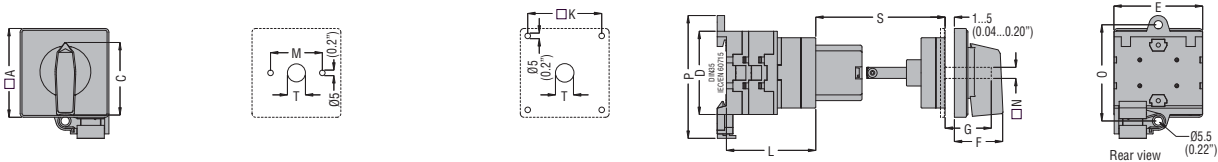

Type	Dimensions											L [mm (in)]							
	A	C	D	E	F	G	K	M	N	O	P	S	T	1 wafer	2 wafers	3 wafers	4 wafers	5 wafers	6 wafers
<b>GX16 O88</b>	48 (1.89")	31 $\phi$ (1.22")	45 (1.77")	48 (1.89")	34 (1.33")	23.5 (0.92")	36 (1.42")	—	6 (0.24")	52 (2.04")	66.5 (2.61")	45-55 (1.77"-2.16")	12 (0.47")	40 (1.57")	48.5 (1.90")	57 (2.24")	65.5 (2.57")	74 (2.91")	82.5 (3.24")
<b>GX20 O88</b>	48 (1.89")	31 $\phi$ (1.22")	45 (1.77")	48 (1.89")	34 (1.33")	23.5 (0.92")	36 (1.42")	—	6 (0.24")	52 (2.04")	66.5 (2.61")	45-55 (1.77"-2.16")	12 (0.47")	40 (1.57")	48.5 (1.90")	57 (2.24")	65.5 (2.57")	74 (2.91")	82.5 (3.24")
<b>GX32 O88</b>	65 (2.56")	45 $\phi$ (1.77")	58 (2.28")	66 (2.59")	38 (1.49")	26 (1.02")	48 (1.89")	—	7 (0.27")	68 (2.68")	78 (3.07")	45-55 (1.77"-2.16")	14 (0.55")	48.7 (1.91")	60.7 (2.38")	72.7 (2.86")	84.7 (3.33")	96.7 (3.80")	108.7 (4.27")
<b>GX40 O98</b>	65 (2.56")	45 $\phi$ (1.77")	58 (2.28")	66 (2.59")	38 (1.49")	26 (1.02")	48 (1.89")	—	7 (0.27")	68 (2.68")	78 (3.07")	45-55 (1.77"-2.16")	14 (0.55")	48.7 (1.91")	60.7 (2.38")	72.7 (2.86")	84.7 (3.33")	96.7 (3.80")	108.7 (4.27")

$\phi$  Padlockable handle.

#### Front ring mount on $\phi 22$ mm drilling, 2-screw fixing

#### Front ring mount on $\phi 22$ mm drilling, 2-screw fixing

#### Modular mount

Type	L [mm (in)]				Type	L [mm (in)]				Type	L [mm (in)]		
	1 wafer	2 wafers	3 wafers	4 wafers		1 wafer	2 wafers	3 wafers	4 wafers		3 wafers	4 wafers	5 wafers
<b>GX16</b>	35 (1.37")	43.5 (1.71")	52 (2.04")	60.5 (2.38")	<b>GX16</b>	35 (1.37")	43.5 (1.71")	52 (2.04")	60.5 (2.38")	<b>GX16</b>	50 (1.97")	58.5 (2.30")	67 (2.64")

#### Snap on mount

Type	L [mm (in)]			
	1 wafer	2 wafers	3 wafers	4 wafers
<b>GX20</b>	35 (1.37")	43.5 (1.71")	52 (2.04")	60.5 (2.38")

### Mounting in enclosure

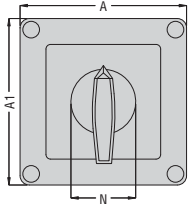

### Drilling for enclosure fixing

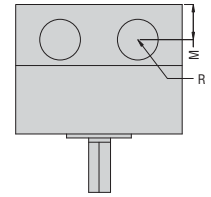
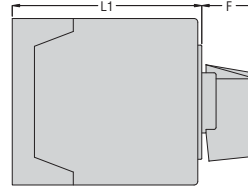
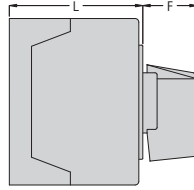
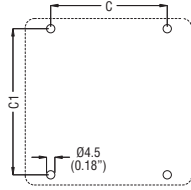

Type	Enclosure size	N° of wafers	L	A	A1	C	C1	F	M	N	L	L1	Protection degree	Cable glands R
<b>GX16</b>	90x90	1-2	3-5	90	90	79	63	25⌀	19	30	71.3	98.3	IP65	4 PG 16
<b>GX20</b>	(3.54"x3.54")	1-2	3-5	(3.54")	(3.54")	(3.11")	(2.48")	(0.98")	(0.74")	(1.18")	(2.80")	(3.87")		
<b>GX32</b>	110x110	1-2	3-4	110	110	98.4	83	32⌀	21	39.5	85.5	119.5	IP65	4 PG 21
<b>GX40</b>	(4.33"x4.33")	1-2	3-4	(4.33")	(4.33")	(3.87")	(3.26")	(1.25")	(0.82")	(1.55")	(3.36")	(4.70")		

● 28 (1.1") for ...P25 type.  
● 38.5 (1.52") for ...P25 type.

### GN SERIES

#### Front mount

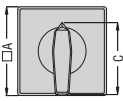

Wafer and front plate fixing on the door

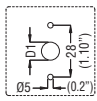

2-screw drilling for types up to GN63

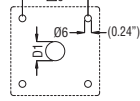

4-screw drilling for GN125 and "4V" suffix types only

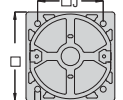

Rear view

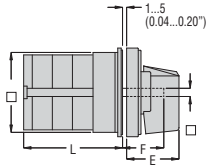

Type	Dimensions										L					
	□ A	C	D1	D3	E	F	□ G	□ J	□ M	□ N	1 wafer	2 wafers	3 wafers	4 wafers	5 wafers	6 wafers
<b>GN12</b>	48 (1.89")	39.5 (1.55")	12 (0.47")	4.3 (0.17")	26.5 (1.04")	23.5 (0.92")	39 (1.53")	36 (1.42")	48 (1.89")	6 (0.24")	36.1 (1.42")	45.8 (1.80")	55.5 (2.18")	65.2 (2.57")	74.9 (2.95")	84.6 (3.33")
<b>GN12⊕</b>	65 (2.56")	53 (2.09")	14 (0.55")	4.3 (0.17")	34.5 (1.36")	26 (1.02")	58 (2.28")	48 (1.89")	65 (2.56")	7 (0.27")	36.6 (1.44")	46.3 (1.82")	56 (2.20")	65.7 (2.59")	75.4 (2.97")	85.1 (3.35")
<b>GN20</b>	48 (1.89")	39.5 (1.55")	12 (0.47")	4.3 (0.17")	26.5 (1.04")	23.5 (0.92")	39 (1.53")	36 (1.42")	48 (1.89")	6 (0.24")	36.1 (1.42")	45.8 (1.80")	55.5 (2.18")	65.2 (2.57")	74.9 (2.95")	84.6 (3.33")
<b>GN20⊕</b>	65 (2.56")	53 (2.09")	14 (0.55")	4.3 (0.17")	34.5 (1.36")	26 (1.02")	58 (2.28")	48 (1.89")	65 (2.56")	7 (0.27")	36.6 (1.44")	46.3 (1.82")	56 (2.20")	65.7 (2.59")	75.4 (2.97")	85.1 (3.35")
<b>GN25</b>	48 (1.89")	39.5 (1.55")	12 (0.47")	4.3 (0.17")	26.5 (1.04")	23.5 (0.92")	39 (1.53")	36 (1.42")	48 (1.89")	6 (0.24")	40.5 (1.59")	54.1 (2.13")	67.7 (2.66")	81.3 (3.20")	94.9 (3.74")	108.5 (4.27")
<b>GN25⊕</b>	65 (2.56")	53 (2.09")	14 (0.55")	4.3 (0.17")	34.5 (1.36")	26 (1.02")	58 (2.30")	48 (1.89")	65 (2.56")	7 (0.27")	41 (1.61")	54.6 (2.15")	68.2 (2.68")	81.8 (3.22")	95.4 (3.75")	109 (4.29")
<b>GN32</b>	65 (2.56")	53 (2.09")	14 (0.55")	4.3 (0.17")	34.5 (1.36")	26 (1.02")	58 (2.30")	48 (1.89")	65 (2.56")	7 (0.27")	46.5 (1.83")	61.6 (2.442")	76.7 (3.02")	91.8 (3.61")	106.9 (4.21")	122 (4.80")
<b>GN40</b>	65 (2.56")	53 (2.09")	14 (0.55")	4.3 (0.17")	34.5 (1.36")	26 (1.02")	58.5 (2.30")	48 (1.89")	65 (2.56")	7 (0.27")	46.5 (1.83")	61.6 (2.442")	76.7 (3.02")	91.8 (3.61")	106.9 (4.21")	122 (4.80")
<b>GN63</b>	65 (2.56")	53 (2.09")	14 (0.55")	4.3 (0.17")	34.5 (1.36")	26 (1.02")	62 (2.44")	48 (1.89")	65 (2.56")	7 (0.27")	50.3 (1.98")	68.4 (2.69")	86.5 (3.40")	104.6 (4.12")	122.7 (4.83")	140.8 (5.54")
<b>GN125</b>	90 (3.54")	70.5 (2.77")	16 (0.63")	5.3 (0.21")	41.5 (1.63")	28 (1.10")	84 (3.31")	68 (2.68")	90 (3.54")	9 (0.35")	67.3 (2.65")	96.4 (3.79")	125.5 (4.94")	154.6 (6.09")	183.7 (7.23")	212.8 (8.38")

⊕ Dimensions for U06 and U25 versions

#### Door coupling

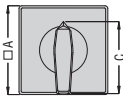

Drillings for wafer and handle fixing

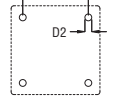

4-screw drilling for wafer fixing on rear plate

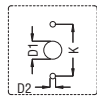

2-screw drilling for handle of types up to GN63

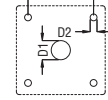

4-screw drilling for GN125 handle and "4V" suffix types only

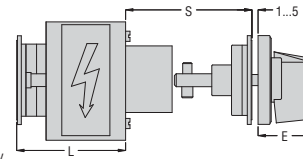

Type	Dimensions							L			
	A	C	D1	D2	E	K	S	1 wafer	2 wafers	3 wafers	4 wafers
<b>GN12-088</b>	65 (2.56")	53 (2.09")	14 (0.55")	5 (0.20")	38.5 (1.52")	48 (1.89")	45-55 (1.77"-2.16")	37.58 (1.48")	47.1 (1.85")	56.7 (2.23")	66.3 (2.61")
<b>GN20-088</b>	65 (2.56")	53 (2.09")	14 (0.55")	5 (0.20")	38.5 (1.52")	48 (1.89")	45-55 (1.77"-2.16")	38.1 (1.50")	47.8 (1.88")	57.5 (2.26")	67.2 (2.64")
<b>GN25-088</b>	65 (2.56")	53 (2.09")	14 (0.55")	5 (0.20")	38.5 (1.52")	48 (1.89")	45-55 (1.77"-2.16")	42.5 (1.67")	56.1 (2.21")	65.7 (2.59")	83.2 (3.27")
<b>GN32 0...</b>	65 (2.56")	53⊕ (2.09")	14 (0.55")	5 (0.20")	34.5 (1.36")	48 (1.89")	45-55 (1.77"-2.16")	49.2 (1.94")	62.8 (2.47")	76.4 (3.00")	90 (3.54")
<b>GN40 0...</b>	65 (2.56")	53⊕ (2.09")	14 (0.55")	5 (0.20")	34.5 (1.36")	48 (1.89")	45-55 (1.77"-2.16")	45.9 (1.81")	59.5 (2.34")	73.1 (2.88")	86.7 (3.41")
<b>GN63 0...</b>	65 (2.56")	53⊕ (2.09")	14 (0.55")	5 (0.20")	34.5 (1.36")	48 (1.89")	45-55 (1.77"-2.16")	54.3 (2.14")	72.4 (2.85")	90.5 (3.56")	108.6 (4.27")
<b>GN125 0...</b>	90 (3.54")	70.5⊕ (2.78")	16 (0.63")	6 (0.24")	41.5 (1.63")	68 (2.68")	45-55 (1.77"-2.16")	74.8 (2.94")	103.9 (4.09")	133 (5.23")	162.1 (6.38")

● 45 (1.77") for O88 and O98 types ⊕.  
● 65 (2.56") for O99 types ⊕.  
● 38.5 (1.52") for O88 and O98 types ⊕.  
● 49 (1.93") for O99 types ⊕.  
⊕ Padlockable handle.

#### Front ring mount on Ø22mm drilling, 2-screw fixing

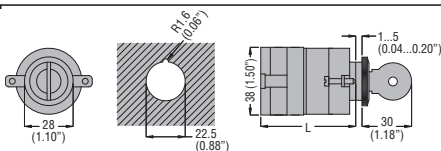

Type	L [mm]			
	1 wafer	2 wafers	3 wafers	4 wafers
<b>GN12</b>	41.5 (1.63")	51.1 (2.01")	60.7 (2.39")	70.3 (2.77")
<b>GN20</b>	42.1 (1.66")	51.8 (2.04")	61.5 (2.42")	71.2 (2.80")
<b>GN25</b>	46.5 (1.83")	60.1 (2.37")	73.7 (2.90")	87.3 (3.44")

#### Front ring mount on Ø22mm drilling, 2-screw fixing

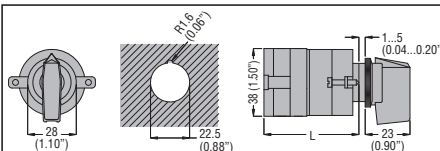

Type	L [mm]			
	1 wafer	2 wafers	3 wafers	4 wafers
<b>GN12</b>	41.5 (1.63")	51.1 (2.01")	60.7 (2.39")	70.3 (2.77")
<b>GN20</b>	42.1 (1.66")	51.8 (2.04")	61.5 (2.42")	71.2 (2.80")
<b>GN25</b>	46.5 (1.83")	60.1 (2.37")	73.7 (2.90")	87.3 (3.44")



# Rotary cam switches

## Dimensions [mm (in)]

Mounting in enclosure

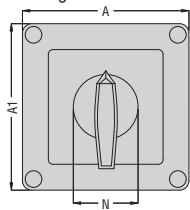

Drilling for enclosure fixing

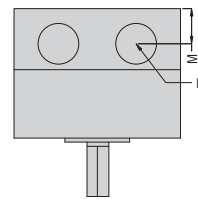
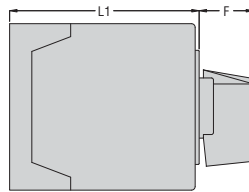
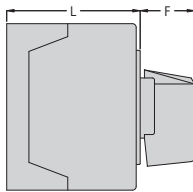
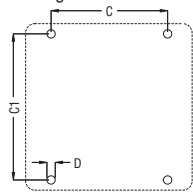

Type	Enclosure size	N° of wafers		Dimensions												Protection degree	Conduits R
		L	L1	A	A1	C	C1	D	F	M	N	L	L1				
GN12	75x75 (2.95x2.95")	1-2	3-4	75	75	64	50	4.5	19 $\text{⌀}$	14	28	57.5	79.8	IP65	4 PG 13.5		
GN20		1-2	3-4	(2.95")	(2.95")	(2.51")	(1.96")	(0.17")	(0.74")	(0.55")	(1.10")	(2.26")	(3.14")				
GN25		1	2-3														
GN20	90x90 (3.54x3.54")	1-3	4-6	90	90	63	79	4.5	25 $\text{⌀}$	19	30	71.3	98.3	IP65	4 PG 16		
GN25		1-2	3-4	(3.54")	(3.54")	(2.48")	(3.11")	(0.17")	(0.98")	(0.74")	(1.18")	(2.80")	(3.87")				
GN32		1-2	3-4														
GN40	1	2-3															
GN32	110x110 (4.33x4.33")	1-3	4-5	110	110	98.4	83	4.5	32 $\text{⌀}$	21	39.5	85.5	119.5	IP65	4 PG 21		
GN40		1-2	3-4	(4.33")	(4.33")	(3.87")	(3.27")	(0.18")	(1.25")	(0.82")	(1.55")	(3.37")	(4.70")				
GN63		1-2	3-4														
GN125	1	2															

$\text{⌀} 28$  (1.1") for P25 type with padlockable handle.  
 $\text{⌀} 38.5$  (1.52") for P25 type with padlockable handle.

90 - One-pole ON/OFF switch

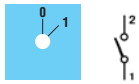

Number of wafers: 1  
Switching angle: 60°

91 - Two-pole ON/OFF switch

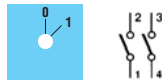

Number of wafers: 1  
Switching angle: 60°

10 - Three-pole ON/OFF switch



Number of wafers: 2  
Switching angle: 60°

92 - Four-pole ON/OFF switch

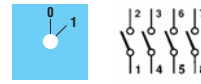

Number of wafers: 2  
Switching angle: 60°

51 - 1-pole changeover / double throw switch with 0

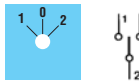

Number of wafers: 1  
Switching angle: 60°

52 - 2-pole changeover / double throw switch with 0

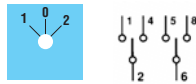

Number of wafers: 2  
Switching angle: 60°

53 - 3-pole changeover / double throw switch with 0



Number of wafers: 3  
Switching angle: 60°

75 - 4-pole changeover / double throw switch with 0

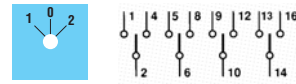

Number of wafers: 4  
Switching angle: 60°

54 - 1-pole changeover / double throw without 0

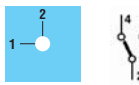

Number of wafers: 1  
Switching angle: 90°

55 - 2-pole changeover / double throw without 0



Number of wafers: 2  
Switching angle: 90°

56 - 3-pole changeover / double throw without 0

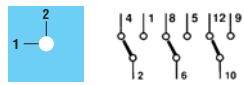

Number of wafers: 3  
Switching angle: 90°

69 - 4-pole changeover / double throw without 0

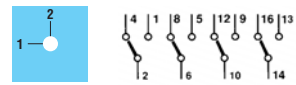

Number of wafers: 4  
Switching angle: 90°

11 - 3-pole reversing switch



Number of wafers: 3  
Switching angle: 60°

13 - Pole-changing switch with 0 (Dahlander)

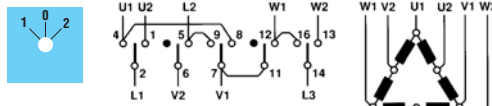

Number of wafers: 4  
Switching angle: 60°

12 - Star-delta switch

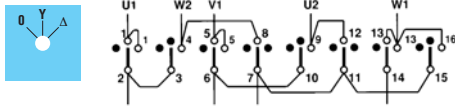

Number of wafers: 4  
Switching angle: 60°

26 - Reversing switch, spring return to 0

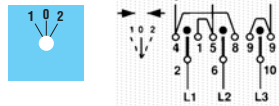

Number of wafers: 3  
Switching angle: 30°

20 - Pole-changing switch with reversing (Dahlander)

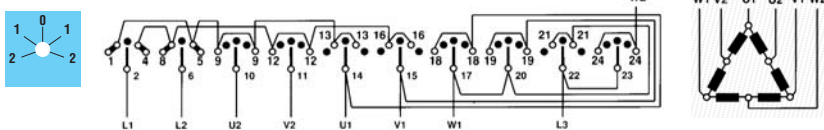

Number of wafers: 6  
Switching angle: 60°

68 - Phase-neutral voltmeter switch



Number of wafers: 2  
Switching angle: 30°

67 - Phase-phase voltmeter switch

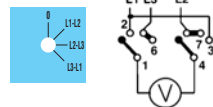

Number of wafers: 2  
Switching angle: 30°

66 - Phase-phase phase-neutral voltmeter changeover / double throw

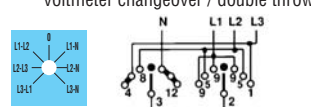

Number of wafers: 3  
Switching angle: 30°

60 - Changeover / double throw switch 1 phase phase-neutral, 3 phase-phase voltages

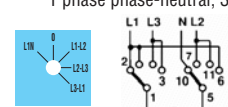

Number of wafers: 3  
Switching angle: 30°

97 - Ammeter switch direct reading or via current transformer

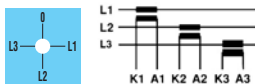

Number of wafers: 5  
Switching angle: 90°

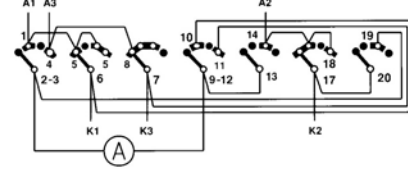

98 - L1-L2-L3 current changeover / double throw switch

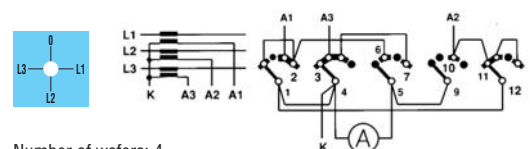

Number of wafers: 4  
Switching angle: 90°

### SELECTION GUIDE

The choice of a rotary cam switch and the relative type are based on the functional diagram and the type of application as well.

IEC standards provide a comprehensible and quick classification of the most frequent utilisation categories:

- AC1: Connection and disconnection of non-inductive or slightly inductive loads ( $\cos\varphi \geq 0.95$ )
- AC21: Resistance furnaces
- AC3: Starting and switching off motors during running
- AC23A: Switching of motor loads or other highly inductive loads
- AC15: Control of electromagnetic loads

For DC applications, the rotary cam switches are used for the switching of minor loads or in control circuits, such as:

- DC13: Control of electromagnets
- DC21A: Switching of resistive loads
- DC23: Switching of highly inductive loads

Other prescriptions and recommendations concerning the use of cam switches as auxiliary equipment of electrical machines are given in IEC/EN 60204-1 standards and specifically as given under utilisation.

### UTILISATION

#### MAIN SUPPLY DISCONNECTING SWITCH WITH EMERGENCY-STOP OPERATION:

- Red operating handle with yellow background
- Lockable in open position (OFF).

#### EMERGENCY-STOP SWITCH

- Red operating handle with yellow background
- Independent operation and the breaking of the load circuit of switching devices before the opening of its main contacts
- Rated capacity is to be sufficient in order to break the sum of the rated operating currents of all the connected equipment
- Breaking capacity equal to the current of the largest motor when stalled (locked rotor) together with the total of the normal running currents of the other motors or loads.

#### MAIN SUPPLY DISCONNECTING SWITCH

- Used to disconnect all live electrical equipment from the power supply circuit
- Contact clearance distance is to comply with IEC/EN 60947-3 standards
- Provided with a means in order to be locked in the OFF position
- Selection of current breaking according to IEC AC1 and AC21 utilisation categories.

10

TYPE		GX16	GX20	GX32	GX40	GN12	GN20	GN25	GN32	GN40	GN63	GN125	
Rated insulation voltage <sup>①</sup> Ui IEC/EN UL/CSA	V	690	690	690	690	690	690	690	690	690	690	690	
	V	600	600	600	600	600	600	600	600	600	600	600	
Rated impulse withstand voltage <sup>①</sup> Uimp IEC/EN 60947-3	kV	6	6	6	6	6	6	6	6	6	6	8	
Conventional free air thermal current Ith IEC/EN UL/CSA (general purpose use)	A	16	20	32	40	16	20	25	32	40	63	125	
	A	12	15	32	40	15	20	30	40	50	60	130	
Rated operating voltage (switch disconnect) <sup>①</sup>	V	440	440	440	440	480	480	480	480	480	480	690	
Operational impulse voltage (switch disconnect)	kV	4	4	4	4	4	4	4	4	4	4	6	
Maximum fuse size for short-circuit protection In (gG)	10kA	A	20	20	40	40	16	20	25	32	40	63	125
	25kA	A	16	16	35	35	10	16	25	32	40	63	100
	50kA	A	-	-	32	35	-	-	-	32	40	63	100
	63kA	A	-	-	-	35	-	-	-	-	40	63	100
Short-time withstand current Icw 1sec	A	250	250	800	800	200	250	400	800	1000	1600	2100	
Rated operational current Ie AC1/AC21A (IEC/EN) AC15 (IEC/EN)	A	16	20	32	40	16	20	25	32	40	63	125	
	110V	A	10	10	25	25	10	10	16	25	25	32	40
	220...230V	A	8	8	20	22	8	8	12	20	22	25	28
	380...400V	A	4	6	10	12	4	6	8	10	12	15	15
	660...690V	A	3	3.7	5.5	7.5	1.5	1.5	2	2	2	4	5
Motor power for switches in AC utilisation categories AC3 (IEC/EN) 3 phases 1 phase (2 poles) AC23A (IEC/EN) 3 phases 1 phase (2 poles)	220...230V	kW	3.5	3.7	7.5	7.5	2.5	3	5.5	7.5	8	11	18.5
	380...440V	kW	4.5	5.5	11	15	4	5.5	7.5	11	15	18.5	37
	500...690V	kW	5.5	5.5	11	15	5.5	5.5	7.5	11	15	18.5	33
	110V	kW	0.55	0.75	1.8	2.2	0.8	0.8	1.5	2.2	3	3.7	5
	220...230V	kW	1.5	1.8	3.5	4.4	1.5	2.2	3	4	6.5	6.5	11
	380...440V	kW	2.2	3	5.5	7	2.2	3	5.5	6.5	8	11.5	15
	220...230V	kW	3.7	4	8	9	3	5	6.5	8	8	12.5	30
	380...440V	kW	6.5	7.5	15	18.5	5.5	7.5	11	15	18.5	30	45
	500...690V	kW	7.5	7.5	15	15	7.5	7.5	11	18.5	22	30	37
	110V	kW	0.75	0.75	2.2	3	0.8	0.8	1.5	2.2	3	3.7	5
220...230V	kW	1.8	2.2	3.5	5.2	1.7	2.5	3.7	4	6	7.5	11	
380...440V	kW	3	3.5	6	7.5	3	3.7	5.5	7.5	11	12.5	15	

① Valid for systems with earthed neutral, overvoltage category III, pollution degree 3.

TYPE			GX16	GX20	GX32	GX40	GN12	GN20	GN25	GN32	GN40	GN63	GN125	
Motor power for direct-on-line control (UL/CSA-DOL) 3 phases	120V	HP	1.5	1.5	3	5	–	–	–	–	–	–	–	
	230V	HP	3	3	7.5	10	3	3	–	–	–	–	–	
	480V	HP	5	5	15	15	–	–	10	15	20	25	50	
	600V	HP	5	5	15	15	–	–	–	–	–	–	40	
	1 phase (2 poles)	120V	HP	0.75	0.75	1.5	2	–	–	–	–	–	–	–
		230V	HP	1	1.5	3	5	–	–	–	–	–	–	–
Motor power for switches in DC utilisation categories														
1 contact DC21A	48V	A	16	20	32	40	12	20	25	32	40	63	125	
	60V	A	16	20	32	40	12	20	25	32	40	50	80	
	le	110V	A	4	4	5	6	4	4	4	6	6	8	10
	220V	A	0.5	0.6	0.8	0.8	0.6	0.6	0.7	0.9	0.9	1	1.2	
	440V	A	0.25	0.25	0.25	0.25	0.25	0.25	–	–	–	–	–	
DC23A	24V	A	16(1)	20(1)	32(1)	40(1)	10(1)	20(1)	25(1)	32(1)	40(1)	50(1)	125(1)	
	48V	A	16(2)	20(2)	32(2)	40(1)	10(2)	20(2)	25(2)	32(2)	40(2)	50(2)	125(2)	
	le	60V	A	16(3)	20(3)	32(3)	40(3)	10(3)	20(3)	25(3)	32(3)	40(3)	50(3)	125(3)
No. of contacts connected in series are indicated in brackets	110V	A	10(3)	10(3)	15(3)	20(3)	5(3)	10(3)	12(3)	15(3)	20(3)	25(3)	50(3)	
	220V	A	7(4)	8(4)	12(4)	12(4)	5(4)	8(4)	10(4)	12(4)	12(4)	15(4)	20(4)	
DC13	24V	A	16	20	32	40	12	20	25	32	40	63	125	
	48V	A	14	16	25	32	10	16	20	25	32	40	100	
	60V	A	12	12	16	16	8	12	16	16	16	28	50	
	le	110V	A	0.8	1	3	3	1	1	1.5	3	3.3	4	
	220V	A	0.3	0.4	0.5	0.5	0.4	0.4	0.4	0.5	–	–	–	
	440V	A	0.15	0.15	0.15	0.15	0.15	0.15	–	–	–	–	–	
Power dissipation	W/pole		0.6	0.6	1.6	1.6	0.8	0.8	1.1	1.5	2.0	3.4	6.3	
Mechanical life	cycles		5x10 <sup>6</sup>	5x10 <sup>6</sup>	5x10 <sup>6</sup>	5x10 <sup>6</sup>	3x10 <sup>6</sup>	5x10 <sup>6</sup>	5x10 <sup>6</sup>	5x10 <sup>6</sup>	5x10 <sup>6</sup>	5x10 <sup>6</sup>	1x10 <sup>6</sup>	
Terminal screw	M		3	3	4	4	3	3	3.5	4	4	5	2x5	
Tightening torque	max	Nm	0.5	0.8	1.2	1.2	0.5	0.5	0.8	1.2	1.2	2	2	
Conductor cross section	max. r/f	2 mm <sup>2</sup>	2.5/2.5	2.5/2.5	10/6	10/6	2.5/2.5	2.5/2.5	4/4	6/4	10/6	16/10	50/50	
		2 AWG	14/14	14/14	8/10	8/10	14/16	12/14	10/12	8/10	8/10	6/8	1/0 / 1/0	
r: rigid/solid f: flexible/stranded	min. r/f	2 mm <sup>2</sup>	0.5/0.5	0.5/0.5	1.5/1.5	1.5/1.5	0.5/0.5	0.5/0.5	0.5/0.5	1.5/1.5	1.5/1.5	2.5/2.5	2.5/2.5	
		2 AWG	20/20	20/20	16/16	16/16	20/20	20/20	20/20	16/16	16/16	14/14	14/14	
AMBIENT CONDITIONS														
Operating temperature	°C		–25...+55											
Storage temperature	°C		–40...+70											