

スナップインタイプ / Snap-in type

セルフロック / Latching

DS-435-S
DS-435E-S

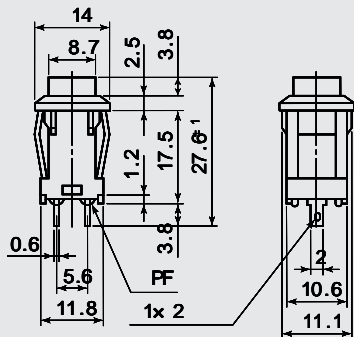

DS-435-P
DS-435E-P

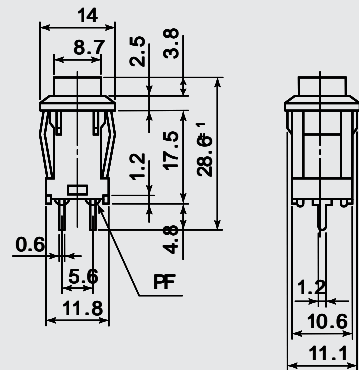

取付穴参考寸法 Mounting Hole	12.2x 11.2mm
パネル板厚 Panel Thickness	1.5~ 3mm

	ボタンカラー	Cap Color
R	赤	Red
K	黒	Black
W	白	White

端子形状 Shape of Terminal	
S	ハンダ端子 Solder Terminal
P	P.C端子 P.C Terminal

品番 PARTS NO.	回路 CIRCUIT	スイッチ特性 SWITCHING FUNCTION	電流容量 RATING	絶縁抵抗 INSULATION RESISTANCE	絶縁耐圧 VOLTAGE BREAKDOWN	接触抵抗 CONTACT RESISTANCE
DS-435-S	SPST (2P)	OFF-ON	3A. 125V.AC 1A. 250V.AC	DC. 500V 100M 以上 (MIN)	AC. 1500V 1分間 (Minute)	20m 以下 (MAX)
DS-435E-S						
DS-435-P						
DS-435E-P						