

**NEW!**

# AP Series Industrial Pushbutton Switch



## Features/Benefits

- IP67 sealed
- 1,000,000 life cycle
- Illumination / non-illumination
- Multiple colored caps
- Threaded or snap-in mounting
- SPST, normally open
- Caps available separately
- RoHS compliant

## Typical Applications

- Harsh environments
- Off-Road
- Industrial
- Medical
- Transportation
- Joystick control modules
- Gaming
- Military



## Specifications

FUNCTION: SPST Momentary, double break  
 CONTACT ARRANGEMENT: N.O.  
 MOUNTING TYPE:  
 Snap-in (panel front) or threaded (nut with locking washer and panel gasket)

## Mechanical

TOTAL TRAVEL: 2.1 ± 0.2 mm  
 OPERATING POINT 1.55 ± 0.25 mm  
 OVER TRAVEL: 0.6 ± 0.2 mm  
 OPERATING FORCE: 4N ± 0.5N standard configuration; other force option 2N ± 0.5N  
 VIBRATION: 10-500 Hz 10g Max  
 SHOCK: 60g 11ms sawtooth wave

## Electrical

CONTACT RATING:  
 200mA @ 24 V DC resistive  
 100mA @ 50 V DC resistive  
 400mA @ 32 V AC resistive  
 125mA @ 125 V AC resistive  
 DIELECTRIC STRENGTH: 1000 V AC min.  
 INSULATION RESISTANCE: 1 G Ω @ 500 VDC  
 INITIAL CONTACT RESISTANCE 50 mΩ max (without wire leads)  
 BOUNCE TIME: <5 ms

## Materials

HOUSING: PBT  
 BASE: PBT  
 CAP: PBT  
 ACTUATOR:  
 Illuminated: Clear polycarbonate  
 Non-illuminated: PBT  
 INTERNAL SEAL: Silicone rubber  
 TERMINALS: Copper alloy, gold over silver plating  
 MOVABLE CONTACT: Copper alloy, gold over silver plating  
 TERMINAL SEAL: Epoxy

## Operating Environment

OPERATING TEMPERATURE: -40°C to 85°C (+105°C non-illuminated)  
 OPERATING LIFE: 1,000,000 cycles

## Process Environment

SEALING: IP67

**NOTE:** Specifications and materials listed above are for switches with standard options. For information on specific and custom switches, please contact Customer Service.

## Build-A-Switch

To order, simply select desired option from each category and place in the appropriate box.

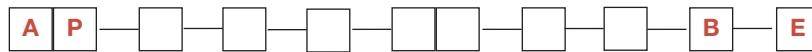

### Designation

AP AP Series

### Operating Force

2 2 Newtons  
 4 4 Newtons

### Actuator Style

D Dome / Convex  
 C Concave  
 E Extended Dome  
 N None

### Actuator Color

0 No Cap  
 2 Black  
 3 Red  
 4 Orange  
 5 Yellow  
 6 Green

### Illumination

00 No LED\*  
 01 Super White  
 02 Bi-color; Red (Green)  
 03 Red  
 05 Amber  
 06 Green  
 07 Super Blue  
 08 Bi-color; Amber (Green)

### Bushing Style\*\*

S Snap-in plastic  
 T\*\*\* Threaded plastic

### Terminal Seal

E Epoxy  
 All models are epoxy sealed

### Contact Material

B Gold

### Termination

Z Solder Lug  
 W 12" Wire Leads 22 AWG  
 C\*\*\*\* PC Terminals

Please contact Customer Service for additional colors and paint / laser etched button options.

\*\* Metal threaded bushing available, contact Customer Service

\*\*\* T bushing style includes: 1 lockwasher, 1 hex nut & 1 panel seal washer

\*\*\*\* Illumination not available with PC Terminals

Contact Customer Service for additional hardware options.

\* No LED available in short body only

Specifications and dimensions subject to change





# AP Series Industrial Pushbutton Switch

**NEW!**

## STANDARD VIEW

A

Pushbutton

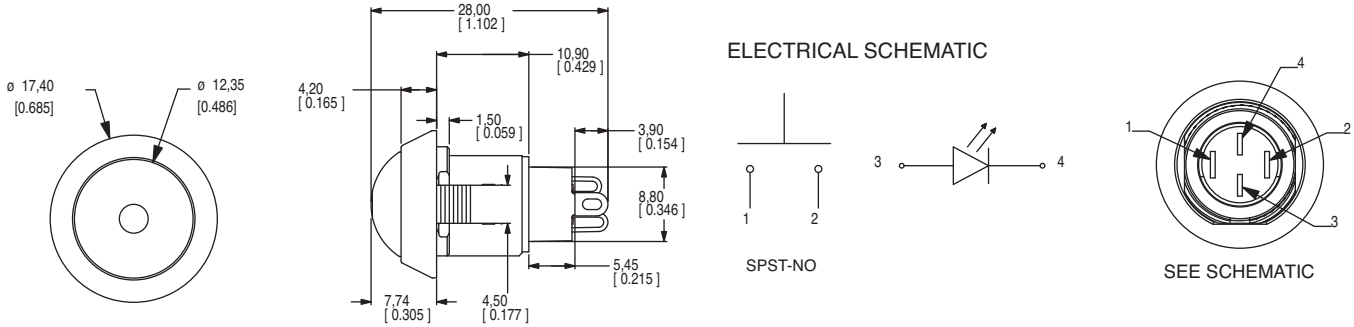

## OPERATING FORCE

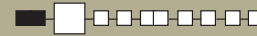

OPTION CODE	OPERATING FORCE
<b>2</b>	2 N, 200 g
<b>4</b>	4 N, 400 g

## ACTUATOR STYLE

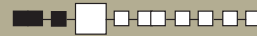

### D DOME / CONVEX

### E EXTENDED DOME

### C CONCAVE

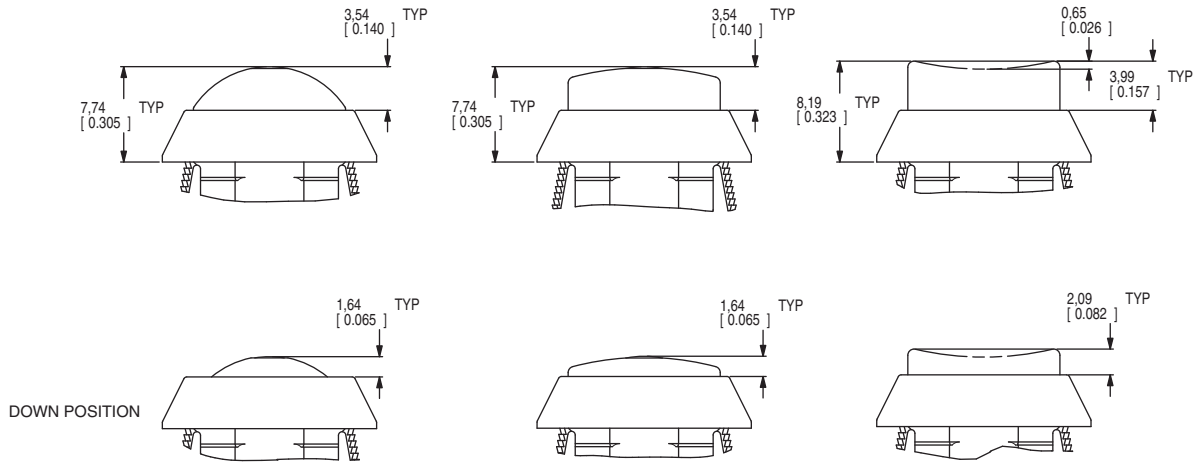

## ACTUATOR COLOR

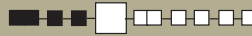

OPTION CODE	ACTUATOR COLOR
<b>0</b>	No Cap
<b>2</b>	Black
<b>3</b>	Red
<b>4</b>	Orange
<b>5</b>	Yellow
<b>6</b>	Green

For additional colors please contact Customer Service.

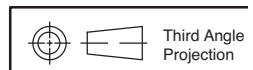

**C&K**

Dimensions are shown: mm (inches)  
Specifications and dimensions subject to change

**NEW!**

# AP Series Industrial Pushbutton Switch



**A**

Pushbutton

## ILLUMINATION



OPTION CODE	ILLUMINATION TYPE	TYPICAL INTENSITY* MAX		PEAK WAVELENGTH	Vf Forward Voltage
		MIN	MAX		
		(mcd)		(nm)	
00	Model without illumination	N/A		N/A	
01	LED Super White	4,000	5,000	N/A	3.5
02	LED Bi-Color – Red (Green)	10	20	635/565	2.0
03	LED Red	4	8	700	2.0
05	LED Amber	35	50	610	2.0
06	LED Green	35	50	565	2.0
07	LED Super Blue	800	1,500	470	3.8
08	LED Bi-Color – Amber (Green)	10	10	585/565	2.0

\*LED FORWARD CURRENT: 20 mA  
 LED FORWARD VOLTAGE: see chart above  
 LED REVERSE VOLTAGE: 5.0 V MAX

\* For information on specific and custom LED, please contact Customer Service.

NOTE:

For bi-color LED's the polarity must be reversed to alternate the color

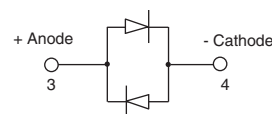

## BUSHING STYLE



### S SNAP-IN

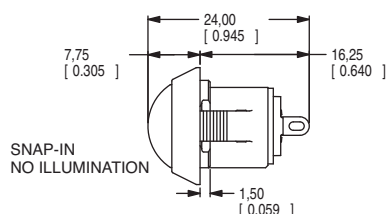
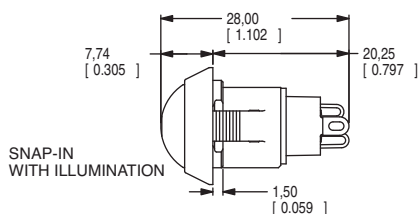

### T THREADED PLASTIC

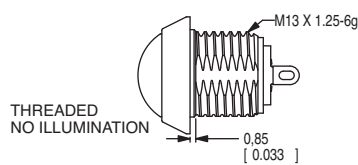
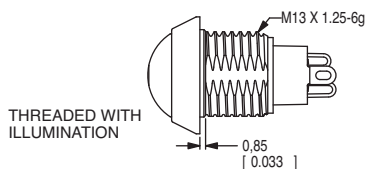

### PANEL CUTOUT

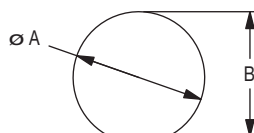

PANEL THICKNESS	DIM A (± 0.05 mm)	DIM B (± 0.05 mm)
1 mm [0.039 in]	13.70 mm [0.539 in]	13.00 mm [0.512 in]
2 mm [0.079 in]	13.80 mm [0.539 in]	13.00 mm [0.512 in]
3 mm [0.118 in]	13.90 mm [0.547 in]	13.10 mm [0.516 in]
THREADED BODY MIN PANEL THICKNESS 1 mm	13.70 mm [0.539 in]	13.00 mm [0.512 in]

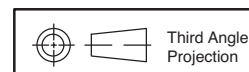

Third Angle Projection



A 0.1mm min. chamfer on the leading edge of the mounting hole is recommended for snap-in version.

Dimensions are shown: mm (inches)  
 Specifications and dimensions subject to change



# AP Series Industrial Pushbutton Switch

**NEW!**

## TERMINATION



**A**

Pushbutton

**Z SOLDER LUG**

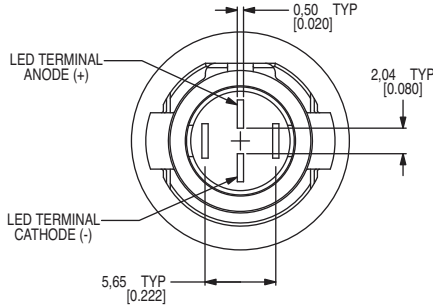
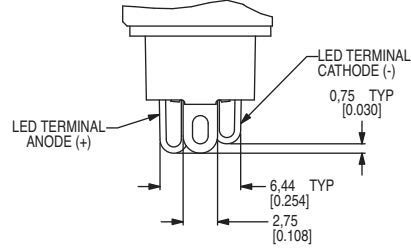
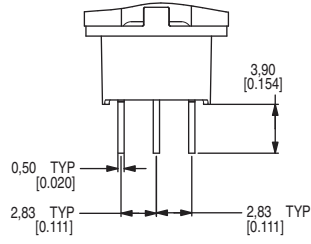

**C PC TERMINALS**

\*\*\*\* Illumination not available with PC Terminals

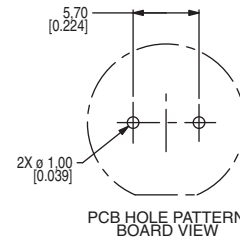
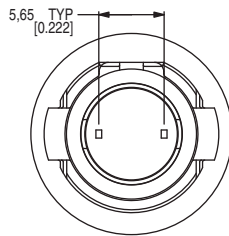
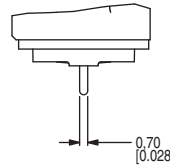
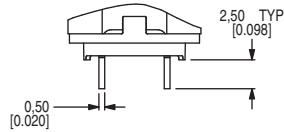

**W 12" WIRE LEADS 22 AWG**

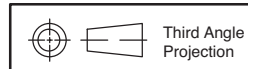
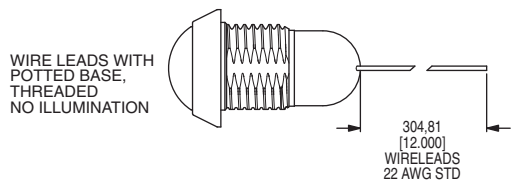
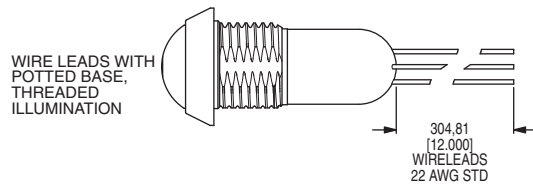
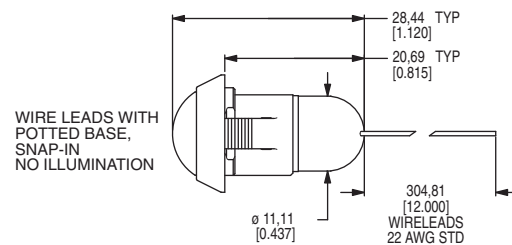
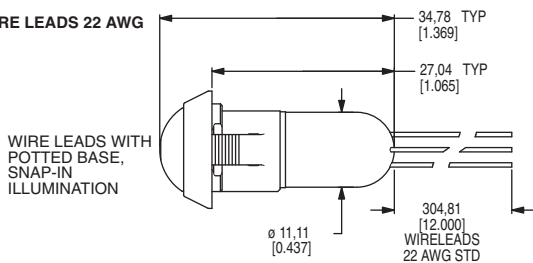

Dimensions are shown: mm (inches)  
Specifications and dimensions subject to change

**NEW!**

# AP Series Industrial Pushbutton Switch



**A**

Pushbutton

## CONTACT MATERIAL



**B** GOLD

OPTION CODE	CONTACT MATERIAL
<b>B</b>	Gold

## TERMINAL SEAL



**E** EPOXY

All models are epoxy sealed

## HARDWARE

**LOCK WASHER**  
Part Number 647D00000

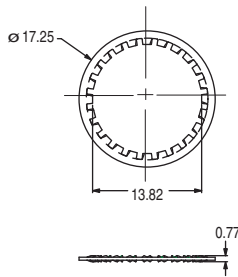

**HEX NUT**  
Part number 515D00000

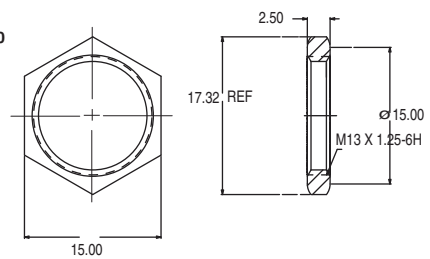

**PANEL SEAL**  
Part Number 655D00000

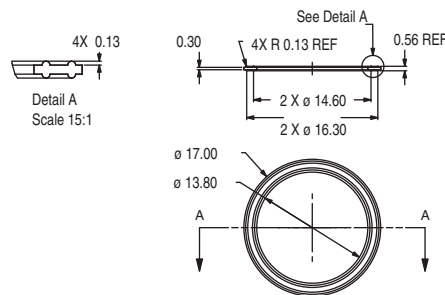

Caps available on next page

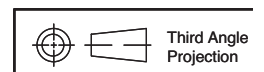

Dimensions are shown: *mm (inches)*  
Specifications and dimensions subject to change



# AP Series Industrial Pushbutton Switch

**NEW!**

## AVAILABLE CAPS

A

Pushbutton



481 X XX 00X  
 Cap ———|  
 Actuator Style ———|  
 Cap Color ———| Hole / No Hole

OPTION	CAP COLOR
02	BLACK
03	RED
04	ORANGE
05	YELLOW
06	GREEN

PART NUMBER	HOLE	ACTUATOR STYLE
481DXX000	NO	DOME
481DXX001	YES	DOME
481CXX000	NO	CONCAVE
481CXX001	YES	CONCAVE
481EXX000	NO	EXTENDED DOME
481EXX001	YES	EXTENDED DOME

**D** DOME

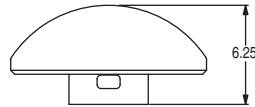
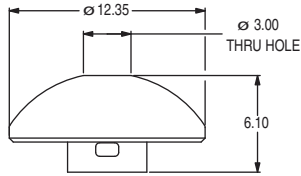

**C** CONCAVE

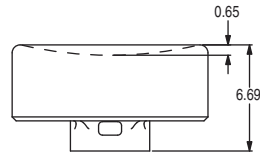
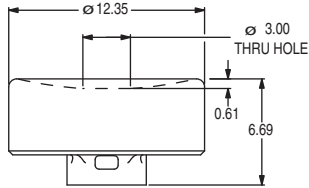

**E** EXTENDED DOME

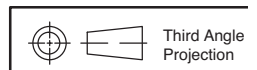
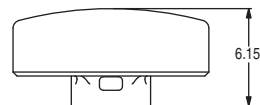
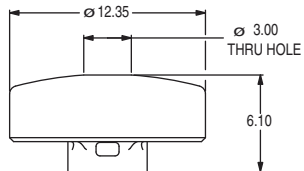

Dimensions are shown: Inches (mm)  
 Specifications and dimensions subject to change