

Sealed Miniature Basic Switch Conforms to IP67 (Molded Lead Wire Type Only)

- Use of epoxy resin assures stable sealing, making this switch ideal for places subject to water spray or excessive dust.
- V-series internal mechanism assures high precision and long life.
- Ideal for automobiles, agricultural machines, large-scale home appliances, and industrial equipment, which require high environmental resistance.

RoHS Compliant



Ordering Information

■ Model Number Legend

D2VW-

□	□	-	□	□
1	2		3	4

1. Ratings

- 5: 5 A at 250 VAC
- 01: 0.1 A at 30 VDC

2. Actuator

- None: Pin plunger
- L1A: Short hinge lever
- L1: Hinge lever
- L1B: Long hinge lever
- L2A: Short hinge roller lever
- L2: Hinge roller lever
- L3: Simulated roller lever







3. Contact Form

- 1: SPDT
- 2: SPST-NC
- 3: SPST-NO

4. Terminals

- None, HS: Solder terminals (HS for UL and CSA approval.)
- M, MS: Molded lead wires (MS for UL and CSA approval) (300 mm length)

■ List of Models

Actuator	Terminals	Rating	5 A	0.1 A
		Contact form		
Pin plunger 	Solder terminals	SPDT	D2VW-5-1	D2VW-01-1
		SPST-NC	D2VW-5-2	D2VW-01-2
		SPST-NO	D2VW-5-3	D2VW-01-3
	Molded lead wire terminals (300 mm)	SPDT	D2VW-5-1M	D2VW-01-1M
		SPST-NC	D2VW-5-2M	D2VW-01-2M
		SPST-NO	D2VW-5-3M	D2VW-01-3M
Short hinge lever 	Solder terminals	SPDT	D2VW-5L1A-1	D2VW-01L1A-1
		SPST-NC	D2VW-5L1A-2	D2VW-01L1A-2
		SPST-NO	D2VW-5L1A-3	D2VW-01L1A-3
	Molded lead wire terminals (300 mm)	SPDT	D2VW-5L1A-1M	D2VW-01L1A-1M
		SPST-NC	D2VW-5L1A-2M	D2VW-01L1A-2M
		SPST-NO	D2VW-5L1A-3M	D2VW-01L1A-3M
Hinge Lever 	Solder terminals	SPDT	D2VW-5L1-1	D2VW-01L1-1
		SPST-NC	D2VW-5L1-2	D2VW-01L1-2
		SPST-NO	D2VW-5L1-3	D2VW-01L1-3
	Molded lead wire terminals (300 mm)	SPDT	D2VW-5L1-1M	D2VW-01L1-1M
		SPST-NC	D2VW-5L1-2M	D2VW-01L1-2M
		SPST-NO	D2VW-5L1-3M	D2VW-01L1-3M
Long hinge lever 	Solder terminals	SPDT	D2VW-5L1B-1	D2VW-01L1B-1
		SPST-NC	D2VW-5L1B-2	D2VW-01L1B-2
		SPST-NO	D2VW-5L1B-3	D2VW-01L1B-3
	Molded lead wire terminals (300 mm)	SPDT	D2VW-5L1B-1M	D2VW-01L1B-1M
		SPST-NC	D2VW-5L1B-2M	D2VW-01L1B-2M
		SPST-NO	D2VW-5L1B-3M	D2VW-01L1B-3M
Short hinge roller lever 	Solder terminals	SPDT	D2VW-5L2A-1	D2VW-01L2A-1
		SPST-NC	D2VW-5L2A-2	D2VW-01L2A-2
		SPST-NO	D2VW-5L2A-3	D2VW-01L2A-3
	Molded lead wire terminals (300 mm)	SPDT	D2VW-5L2A-1M	D2VW-01L2A-1M
		SPST-NC	D2VW-5L2A-2M	D2VW-01L2A-2M
		SPST-NO	D2VW-5L2A-3M	D2VW-01L2A-3M
Hinge roller lever 	Solder terminals	SPDT	D2VW-5L2-1	D2VW-01L2-1
		SPST-NC	D2VW-5L2-2	D2VW-01L2-2
		SPST-NO	D2VW-5L2-3	D2VW-01L2-3
	Molded lead wire terminals (300 mm)	SPDT	D2VW-5L2-1M	D2VW-01L2-1M
		SPST-NC	D2VW-5L2-2M	D2VW-01L2-2M
		SPST-NO	D2VW-5L2-3M	D2VW-01L2-3M
Simulated roller lever 	Solder terminals	SPDT	D2VW-5L3-1	D2VW-01L3-1
		SPST-NC	D2VW-5L3-2	D2VW-01L3-2
		SPST-NO	D2VW-5L3-3	D2VW-01L3-3
	Molded lead wire terminals (300 mm)	SPDT	D2VW-5L3-1M	D2VW-01L3-1M
		SPST-NC	D2VW-5L3-2M	D2VW-01L3-2M
		SPST-NO	D2VW-5L3-3M	D2VW-01L3-3M

- Note:**
1. The standard lengths of the molded lead wires (AV0.75f) of models incorporating them are 300 mm.
 2. Add "HS" or "MS" to the end of the model number for the UL/CSA-approved version (e.g., D2VW-01-1 → D2VW-01-1HS). Consult your OMRON sales representative for details.

Specifications

■ Ratings

Model	Item Rated voltage	Resistive load
D2VW-5	250 VAC	5 A
	125 VAC	5 A
	30 VDC	5 A
D2VW-01	125 VAC	0.1 A
	30 VDC	0.1 A

Note: The ratings values apply under the following test conditions:

Ambient temperature: 20±2°C

Ambient humidity: 65±5%

Operating frequency: 30 operations/min

■ Characteristics

Operating speed	0.1 mm to 1 m/s (pin plunger models)
Operating frequency	Mechanical: 300 operations/min max. Electrical: 30 operations/min max.
Insulation resistance	100 MΩ min. (at 500 VDC)
Contact resistance (initial value)	50 mΩ max. (100 mΩ max. for molded lead wire models)
Dielectric strength (see note 2)	1,000 VAC, 50/60 Hz for 1 min between terminals of same polarity 1,500 VAC, 50/60 Hz for 1 min between current-carrying metal parts and ground 1,500 VAC, 50/60 Hz for 1 min between each terminal and non-current-carrying metal parts
Vibration resistance (see note 3)	Malfunction: 10 to 55 Hz, 1.5-mm double amplitude
Shock resistance (see note 3)	Destruction: 1,000 m/s ² {approx. 100G} max. Malfunction: 300 m/s ² {approx. 30G} max.
Durability (see note 4)	Mechanical: 10,000,000 operations min. (60 operations/min) Electrical: D2VW-5 models: 100,000 operations min. (30 operations/min) D2VW-01 models: 1,000,000 operations min. (30 operations/min)
Degree of protection	IEC IP67 (excluding the terminals on terminal models)
Degree of protection against electric shock	Class I
Proof tracking index (PTI)	175
Ambient operating temperature (see note 5)	-40°C to 85°C (at ambient humidity of 60% max.) (with no icing or condensation)
Ambient operating humidity	95% max. (for 5°C to 35°C)
Weight	Approx. 7 g (pin plunger models with terminals)

Note: 1. The data given above are initial values.

2. The dielectric strength shown in the table indicates the value for models with a Separator.

3. For the pin plunger models, the above values apply for use at both the free position and total travel position. For the lever models, they apply at the total travel position.

4. For testing conditions, consult your OMRON sales representative.

■ Approved Standards

Consult your OMRON sales representative for specific models with standard approvals.

**UL1054 (File No. E41515)/
CSA C22.2 No.55 (File No. LR21642)**

Rated voltage	D2VW-5	D2VW-01
125 VAC	3 A	0.1 A
250 VAC	3 A	---
30 VDC	---	0.1 A

EN61058-1 (File No. 104068, VDE approval)

Rated voltage	D2VW-5	D2VW-01
125 VAC	---	0.1 A
250 VAC	3 A	---

Testing conditions:
25E3 (25,000 operations), T55 (0°C to 55°C) for D2VW-5,
1E5 (100,000 operations), T85 (0°C to 85°C) for D2VW-01

■ Contact Form

SPDT

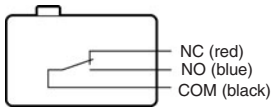

SPST-NC

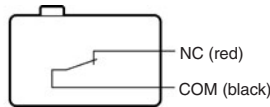

SPST-NO

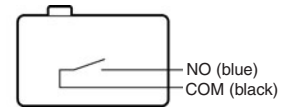

Note: Colors in parentheses indicate lead wire colors.

Dimensions

Note: All units are in millimeters unless otherwise indicated.

■ Terminals

The pin plunger model is shown here as a typical example. Operating characteristics and dimensions of the actuator section are the same as for the molded lead wire models.

Solder/Quick Connect Terminals

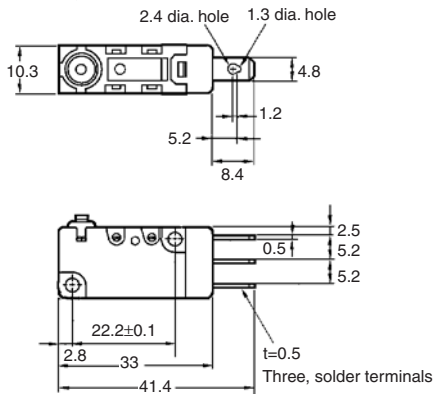

Molded Lead Wires

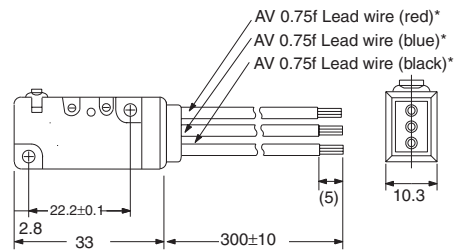

* UL/CSA approved models use UL approved wiring (AWG20, UL1015)

■ Mounting Holes

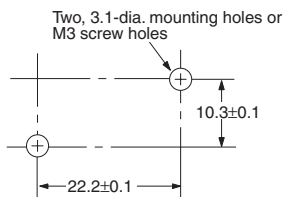

■ Dimensions and Operating Characteristics

- Note:**
1. All units are in millimeters unless otherwise indicated.
 2. Unless otherwise specified, a tolerance of ± 0.4 mm applies to all dimensions.
 3. The operating characteristics are for operation in the A direction (▼).
 4. The following illustrations and drawing are for molded lead wires (M). Refer to kind of terminals on page 4 for terminals.

Pin Plunger Models

D2VW-5-1□
D2VW-01-1□

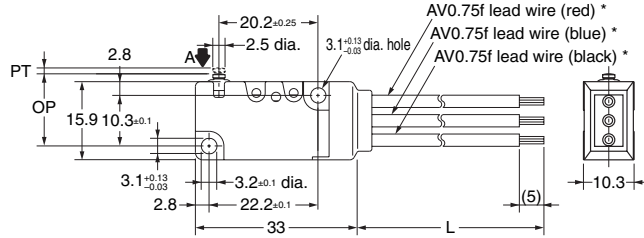
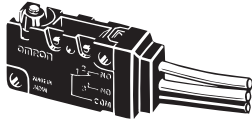

Wire length

	300 mm
L	300 ± 10

OF max.	1.96 N {200 gf}
RF min.	0.29 N {30 gf}
PT max.	1.2 mm
OT min.	1.0 mm
MD max.	0.4 mm
OP	14.7 ± 0.4 mm

*UL/CSA certified models: UL certified wire (AWG20, UL1015)

Short Hinge Lever Models

D2VW-5L1A-1□
D2VW-01L1A-1□

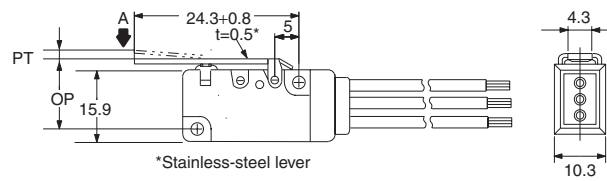
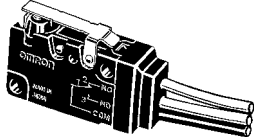

*Stainless-steel lever

OF max.	1.96 N {200 gf}
RF min.	0.20 N {20 gf}
PT max.	1.6 mm
OT min.	0.8 mm
MD max.	0.5 mm
OP	15.2 ± 0.5 mm

Hinge Lever Models

D2VW-5L1-1□
D2VW-01L1-1□

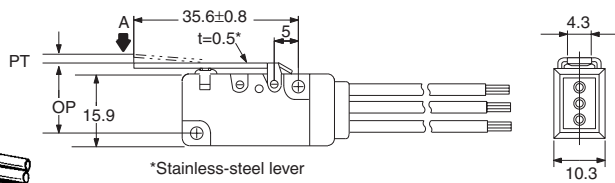
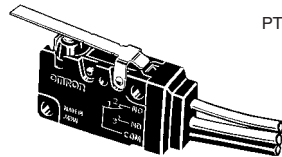

*Stainless-steel lever

OF max.	1.18 N {120 gf}
RF min.	0.15 N {15 gf}
PT max.	4.0 mm
OT min.	1.6 mm
MD max.	0.8 mm
OP	15.2 ± 1.2 mm

Long Hinge Lever Models

D2VW-5L1B-1□
D2VW-01L1B-1□

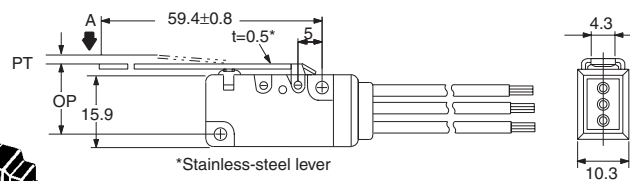
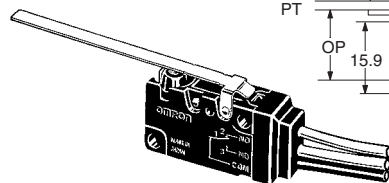

*Stainless-steel lever

OF max.	0.59 N {60 gf}
RF min.	0.05 N {5 gf}
PT max.	9.0 mm
OT min.	3.2 mm
MD max.	2.0 mm
OP	15.2 ± 2.6 mm

Short Hinge Roller Lever Models

D2VW-5L2A-1□
D2VW-01L2A-1□

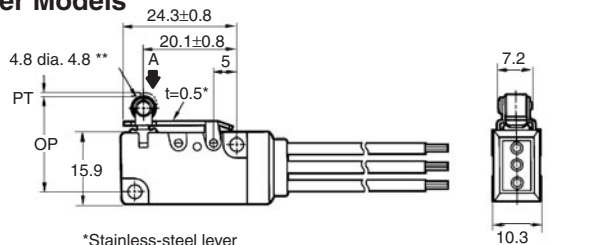
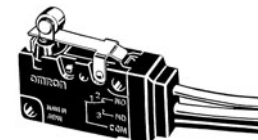

*Stainless-steel lever
**Oil-less polyacetal resin roller

OF max.	2.25 N {230 gf}
RF min.	0.20 N {20 gf}
PT max.	1.6 mm
OT min.	0.8 mm
MD max.	0.5 mm
OP	20.7 ± 0.6 mm

Hinge Roller Lever Models

D2VW-5L2-1□
D2VW-01L2-1□

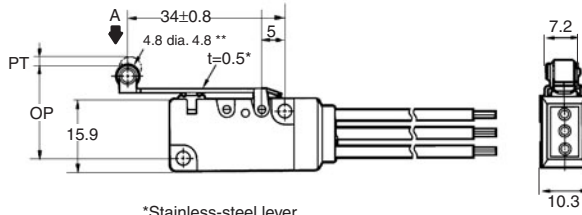
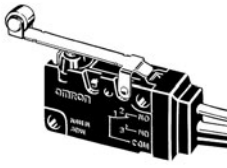

*Stainless-steel lever
**Oil-less polyacetal resin roller

OF max.	1.18 N {120 gf}
RF min.	0.15 N {15 gf}
PT max.	4.0 mm
OT min.	1.6 mm
MD max.	0.8 mm
OP	20.7±1.2 mm

Simulated Roller Lever Models

D2VW-5L3-1□
D2VW-01L3-1□

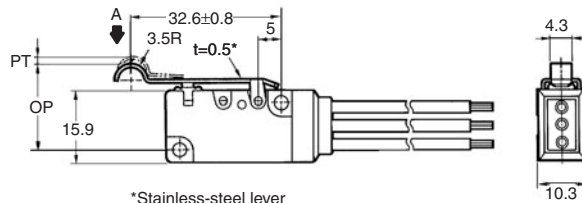
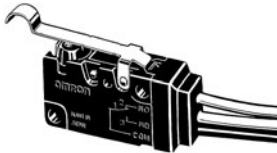

*Stainless-steel lever

OF max.	1.18 N {120 gf}
RF min.	0.15 N {15 gf}
PT max.	4.0 mm
OT min.	1.6 mm
MD max.	0.8 mm
OP	18.7±1.2 mm

Precautions

Refer to *General Information*.

■ Cautions

Degree of Protection

Do not use the Switch underwater. The Switch was tested and found to meet the conditions necessary to meet the following standard. The test checks for water intrusion after immersion for a specified time period. The test does not check for switching operation underwater.

IEC Publication 529, degree of protection IP67.

Protection Against Chemicals

Prevent the Switch from coming into contact with oil and chemicals. Otherwise, damage to or deterioration of Switch materials may result.

■ Correct Use

Mounting

Use M3 mounting screws with plane washers or spring washers to securely mount the Switch. Tighten the screws to a torque of 0.39 to 0.59 N·m {4 to 6 kgf·cm}.

Operating Body

With the pin plunger models, set the Switch so that the plunger can be pushed in from directly above. Since the plunger is covered with a rubber cap, applying a force from lateral directions may cause damage to the plunger or reduction in the sealing capability.

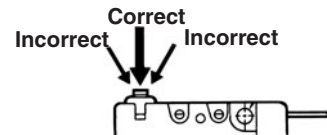

Handling

Handle the Switch carefully so as not to break the sealing rubber of the plunger.

Using Micro Loads

Using a model for ordinary loads to open or close the contact of a micro load circuit may result in faulty contact. Use models that operate in the following range. However, even when using micro load models within the operating range shown below, if inrush current occurs when the contact is opened or closed, it may increase contact wear and so decrease durability. Therefore, insert a contact protection circuit where necessary.

The minimum applicable load is the N-level reference value. This value indicates the malfunction reference level for the reliability level of 60% (λ_{60}). The equation, $\lambda_{60} = 0.5 \times 10^{-6} / \text{operations}$ indicates that the estimated malfunction rate is less than 1/2,000,000 operations with a reliability level of 60%.

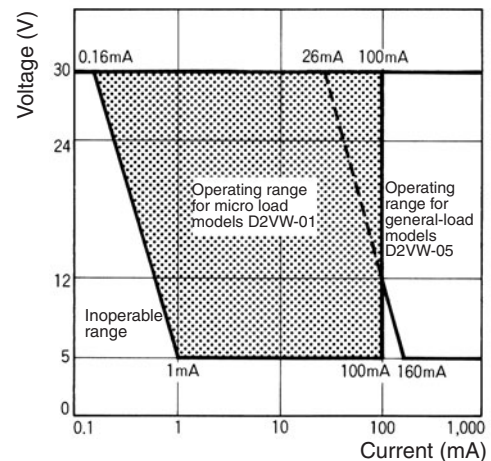

ALL DIMENSIONS SHOWN ARE IN MILLIMETERS.

To convert millimeters into inches, multiply by 0.03937. To convert grams into ounces, multiply by 0.03527.