

■Features

- High Luminous LEDs
- 2*3*4mm Rectangular Standard Directivity
- Long Lifetime Operation
- Superior Weather-resistance
- UV Resistant Epoxy/ Water Clear Type
- Bi-Color LED

■Applications

- Toys
- Audio
- Games
- Other Lighting

■Outline Dimension

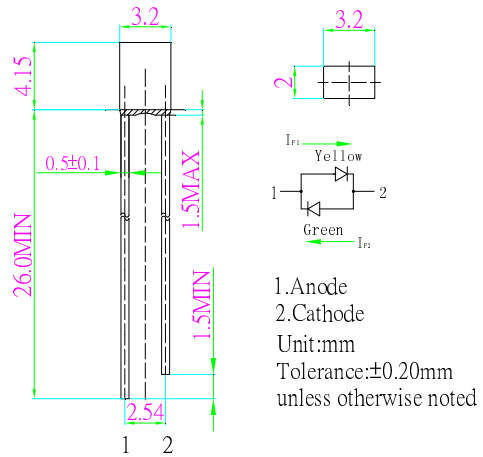

■Absolute Maximum Rating

(Ta=25°C)

Item	Symbol	Value		Unit
		YL	PG	
DC Forward Current	I _F	50	30	mA
Pulse Forward Current*	I _{FP}	100	100	mA
Reverse Voltage	V _R	5	5	V
Power Dissipation	P _D	130	102	mW
Operating Temperature	Topr	-30 ~ +85		°C
Storage Temperature	Tstg	-40 ~ +100		°C
Lead Soldering Temperature	Tsol	260°C/5sec		-

*Pulse width Max.10ms Duty ratio max 1/10

■Directivity

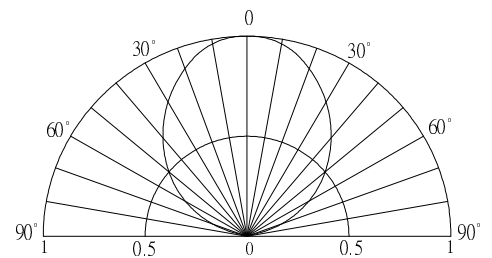

■Electrical -Optical Characteristics

(Ta=25°C)

Item	Color.	Symbol	Condition	Min.	Typ.	Max.	Unit
DC Forward Voltage	YL	V _{F1}	I _{F1} =20mA	1.8	2.1	2.6	V
	PG	V _{F2}	I _{F2} =20mA	2.7	3.0	3.4	V
Domi. Wavelength*	YL	λ _{D1}	I _{F1} =20mA	585	590	595	nm
	PG	λ _{D2}	I _{F2} =20mA	520	525	530	nm
Luminous Intensity*	YL	I _{V1}	I _{F1} =20mA	500	750	-	mcd
	PG	I _{V2}	I _{F2} =20mA	750	1120	-	mcd
50%Power Angle	YL	2θ _{1/2}	I _{F1} =20mA	-	100	-	deg
	PG	2θ _{1/2}	I _{F2} =20mA	-	100	-	deg

*1 Tolerance of measurements of dominant wavelength is ±1nm

*2 Tolerance of measurements of Luminous Intensity is ±15%

*3 Tolerance of measurements of forward voltage is ±0.1