

### ■Features

- High Luminous LEDs
- 2x5x7mm Rectangular Standard Directivity
- Superior Weather-resistance
- UV Resistant Epoxy
- Water Clear Type

### ■Applications

- Traffic signal, Portable light source
- Signage and channel letter
- Decorating and entertainment lighting
- Architectural lighting
- Outdoor/Indoor applications/Other Lighting

### ■Outline Dimension

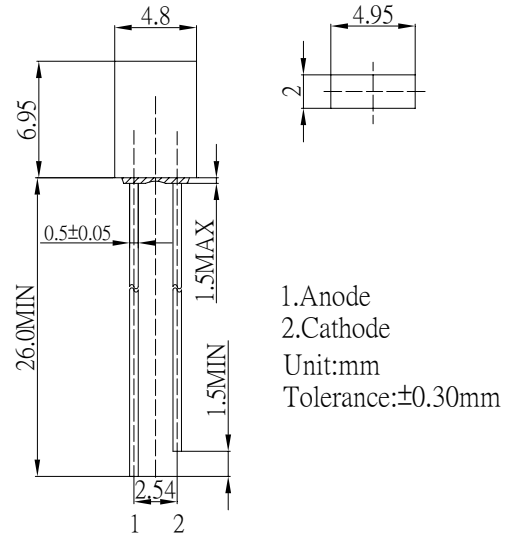

### ■Absolute Maximum Rating

(Ta=25°C)

Item	Symbol	Value	Unit
DC Forward Current	I <sub>F</sub>	50	mA
Pulse Forward Current*	I <sub>FP</sub>	120	mA
Reverse Voltage	V <sub>R</sub>	5	V
Power Dissipation	P <sub>D</sub>	130	mW
Operating Temperature	Topr	-40~ +85	°C
Storage Temperature	Tstg	-40 ~ +100	°C
Lead Soldering Temperature	Tsol	260°C/5sec	-

\*Pulse width Max.10ms , Duty ratio max 1/10

### ■Directivity

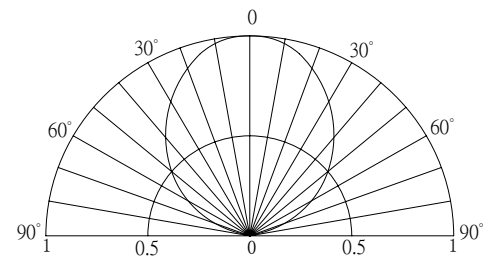

### ■Electrical -Optical Characteristics

(Ta=25°C)

Item	Symbol	Condition	Min.	Typ.	Max.	Unit
DC Forward Voltage	V <sub>F</sub>	I <sub>F</sub> =20mA	1.8	2.1	2.6	V
DC Reverse Current	I <sub>R</sub>	V <sub>R</sub> =5V	-	-	10	μA
Domi. Wavelength*	λ <sub>D</sub>	I <sub>F</sub> =20mA	585	590	595	nm
Luminous Intensity*	I <sub>v</sub>	I <sub>F</sub> =20mA	1120	1500	-	mcd
50% Power Angle	2θ <sub>1/2</sub>	I <sub>F</sub> =20mA	-	100	-	deg

\*1 Tolerance of dominant wavelength is ±1nm

\*2 Tolerance of luminous intensity is ±15%

### ■Maximum Forward Current

