

■ Features

- High Luminous LEDs
- 5.0x4.1mm Standard Directivity
- Superior Weather-resistance
- UV Resistant Epoxy
- Water Clear Type

■ Applications

- Electronic Signs And Signals
- Small Area Illuminations
- Back Lighting
- Other Lighting

■ Outline Dimension

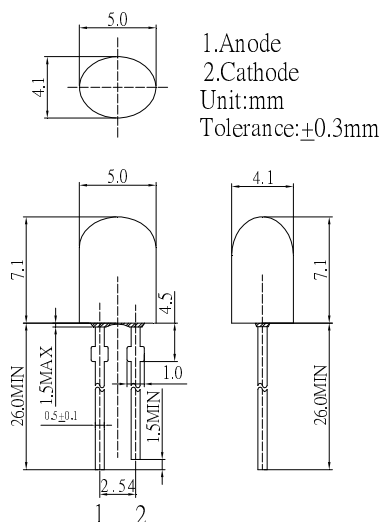

■ Absolute Maximum Rating

(Ta=25°C)

Item	Symbol	Value	Unit
DC Forward Current	I _F	30	mA
Pulse Forward Current*	I _{FP}	100	mA
Reverse Voltage	V _R	5	V
Power Dissipation	P _D	108	mW
Operating Temperature	Topr	-30 ~ +85	°C
Storage Temperature	Tstg	-40~ +100	°C
Lead Soldering Temperature	Tsol	260°C/5sec	-

*Pulse width Max.10ms Duty ratio max 1/10

■ Directivity

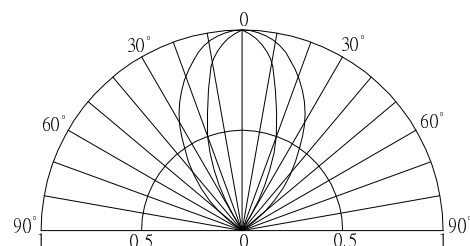

■ Electrical -Optical Characteristics

(Ta=25°C)

Item	Symbol	Condition	Min.	Typ.	Max.	Unit
DC Forward Voltage	V _F	I _F =20mA	2.9	3.1	3.6	V
DC Reverse Current	I _R	V _R =5V	-	-	10	μA
Domi. Wavelength*	λ _D	I _F =20mA	520	525	530	nm
Luminous Intensity*	I _v	I _F =20mA	12000	15000	-	mcd
50% Power Angle	2θ _{1/2}	I _F =20mA	-	70/40	-	deg

*1 Tolerance of dominant wavelength is ±1nm

*2 Tolerance of luminous intensity is ±15%