



Wah Wang Data Sheet for Rectangle Type 5mm Super Bright White LED

5G3 Series

Angle: 100°

Class: T

Part No: WW05G3SWT4-W



Address : Unit 01, 19th Floor, Nanyang Plaza,
No.57 Hung To Road, Kwun Tong,
Kowloon, Hong Kong
Tel : 852-2512 9939 (10 line)
Fax : 852-2344 2398
Web Site : www.wahwang.com

S.D.N. or D.N. No. : _____

Customer Name : _____

Sample Approval Signature : _____

Date : _____



Wah Wang Data Sheet For 5mm Super Bright White LED – 5G3 Series Angle 100° Class: T

Features

- Standard T-1 Diameter Type Package.
- General Purpose Leads
- Reliable and Rugged

Absolute Maximum Ratings at Ta=25°C

Parameter	MAX.	Unit
Power Dissipation	100	mW
Peak Forward Current (≤ 1/10 Duty Cycle, 0.1ms Pulse Wide)	100	mA
Continuous Forward Current	20	mA
Reverse Voltage	5	V
Operating Temperature Range	-40°C to +65°C	
Storage Temperature Range	-40°C to +80°C	
Lead Soldering Temperature [3mm(From solder joint to epoxy body)]	260°C for 3 Seconds	

Package Dimensions

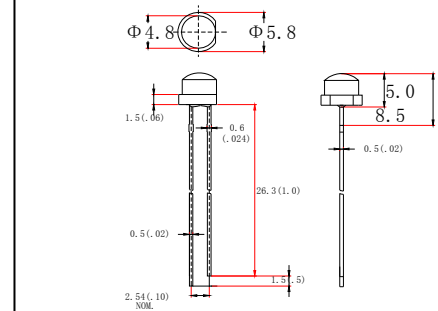

Electrical Optical Characteristics at Ta=25°C

Part Number	Lens color	Source Color	Luminous Intensity Iv / mcd at I _F = 20mA (Note 5)			Forward Voltage / V at I _F = 20mA			Viewing Angle / Deg (Note 6)
			Min.	Typ.	Max.	Min.	Typ.	Max.	
WW05G3SWT4-W	Water Clear	White	1700	2200	---	2.8	---	3.4	100°
Reverse Voltage = 5V					Reverse Current ≤ 5μA				

Notes:

1. All dimensions are in millimeter.
2. Tolerance of measurement is $\pm 0.25\text{mm}(0.01")$ unless others otherwise noted.
3. Protruded resin under flanges is 1.0mm(0.4") max.
4. Lead spacing is measured where the leads emerge from the package.
5. Luminous intensity is measured with a light sensor and filter combination that approximates the CIE eye-response curve. Tolerance of measurement of luminous intensity is $\pm 15\%$
6. $\theta_{1/2}$ is the off-axis angle at which the luminous intensity is half the axial luminous intensity. It use many parameters that correspond to the CIE 1931 2° Tolerance of measurement of angle is ± 10 degree
7. Caution in ESD: Static Electricity and surge damages the LED. It is recommended to use a wrist band or anti-electrostatic glove when handling the LED. All devices, equipment and machinery must be properly grounded.
8. X, Y, and Z are CIE1931 2° values of Red, Green and Blue content of the measurement. Color Coordinates Measurement allowance is ± 0.01
9. Specifications are subject to change without notice.



Chromaticity Coordinates Specifications for Bin Grading: COLOR RANKS (IF=20mA;Ta=25°C)

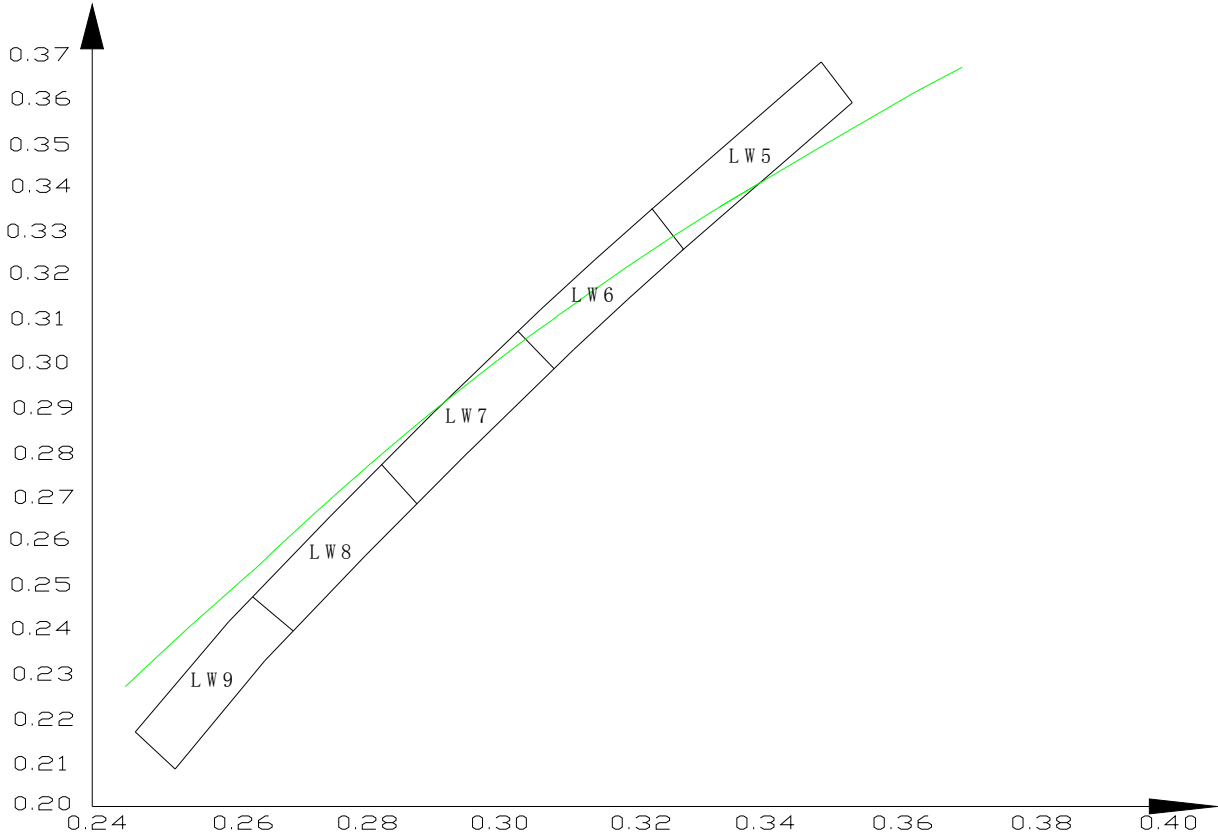

Notes:

Color Ranks		White			
LW5	X	0.3065	0.3124	0.3391	0.3332
	Y	0.3270	0.3186	0.3676	0.3760
LW6	X	0.2865	0.2924	0.3191	0.3132
	Y	0.2903	0.2819	0.3309	0.3393
LW7	X	0.2731	0.2790	0.3057	0.2998
	Y	0.2658	0.2574	0.3064	0.3148
LW8	X	0.2597	0.2656	0.2924	0.2865
	Y	0.2413	0.2329	0.2819	0.2903
LW9	X	0.2464	0.2523	0.2790	0.2731
	Y	0.2168	0.2084	0.2574	0.2658

Color	Group	Customer Ranks	Factory code	TC(K)
White	5	LW5	LDc-f	5500-6500
	6	LW6	LD9-c	6500-8500
	7	LW7	LD7-a	8000-12000
	8	LW8	LD5-8	10000-20000
	9	LW9	LD3-6	15000-30000

*Customer can choose any group

*Tolerance of Color Temperature is upper 9000K ±800K / 9000K-5000K ±500K / below 5000K ±200K

*X and Y are CIE1931; Color Coordinates Measurement allowance is ±0.01



Typical Characteristic for Super Bright White LED

Forward Current vs. Chromaticity Coordinate (λD)

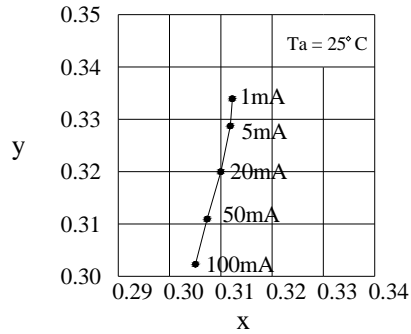

Spectrum

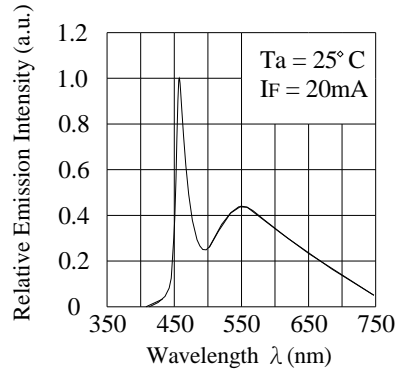

Ambient Temperature vs. Chromaticity Coordinate (λD)

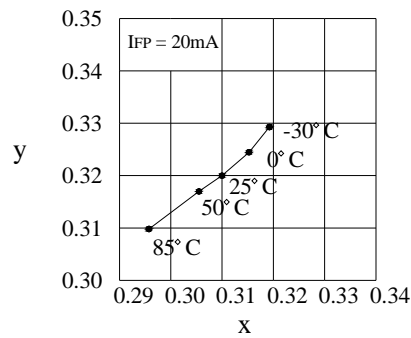

Directivity (Angle : 100°)

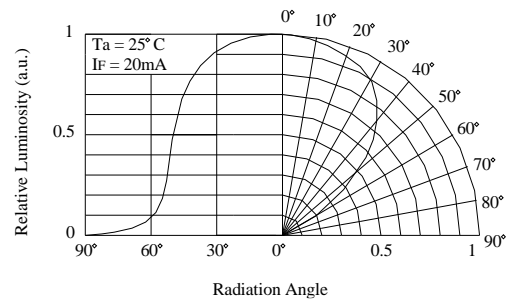

Forward Voltage vs. Forward Current

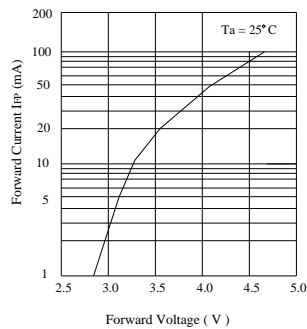

Forward Current vs. Relative Luminosity

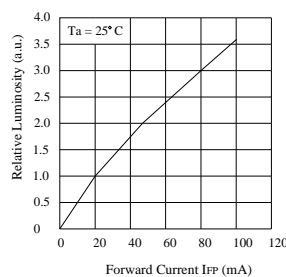

Duty Ratio vs. Allowable Forward Current

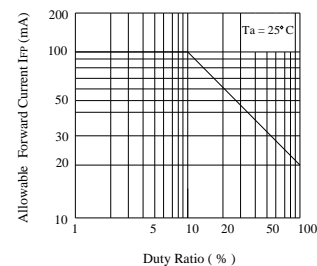

Ambient Temperature vs. Forward Voltage

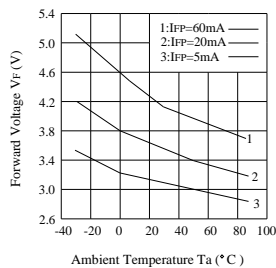

Ambient Temperature vs. Relative Luminosity

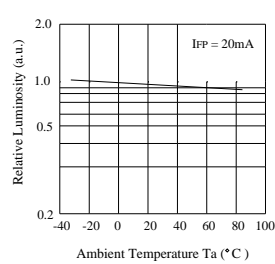

Ambient Temperature vs. Allowable Forward Current

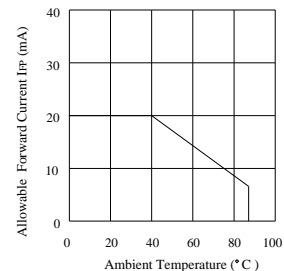



CAUTIONS- Super Bright White LED

Because the White LEDs are made by combining Blue LEDs and special phosphors. Hence, the color of White LEDs is changed a little by an operation current. Care should be taken after due consideration when using LEDs.

- (1) Lead Forming
 - a. At least 3mm from the base of the epoxy bulb should be kept when forming leads.
 - b. Do not use the base of the leadframe as a fulcrum during lead forming. Lead forming should be done before soldering.
 - c. Because the stress to the base may damage the characteristics or it may break the LEDs, do not apply any bending stress to the base of the lead
 - d. When mounting the LEDs onto a PCB, the holes on the circuit board should be exactly aligned with the leads of the LEDs. Stress at the leads should be avoided when the LEDs are mounted on the PCB, because it causes damage to the epoxy resin and this will degrade the LEDs.

- (2) Storage
 - a. The LEDs should be stored at 30°C or less and 70%RH or less after being shipped and the storage life limits are 3 months.
 - b. If the LEDs are stored more than 3 months, they can be stored for a year in a sealed container with a nitrogen atmosphere and moisture absorbent material.
 - c. Please avoid rapid transitions in ambient temperature, especially, in high humidity environments where condensation can occur.

- (3) Static Electricity
 - a. Static electricity or surge voltage damages the LEDs.
 - b. It is recommended that a wristband or an anti-electrostatic glove be used when handling the LEDs.
 - c. All devices, equipment and machinery must be properly grounded.
 - d. It is recommended that measures be taken against surge voltage to the equipment that mounts the LEDs.
 - e. Damaged LEDs will show some unusual characteristics such as the leak current remarkably increases, the forward voltage becomes lower, or the LEDs do not light at the low current.
Criteria: (VF>2.0V at IF=0.5mA)

- (4) Heat Generation
 - a. Thermal design of the end product was most important. Please consider the heat generation of the LED when making the system design.
 - b. The thermal resistance of the circuit board and density of LED placement on the board, as well as other components was the important factor affecting the coefficient of temperature increase per input electric power. It must be avoided to have intense heat generation and operate within the maximum ratings given in the specification.
 - c. The operating current should be decided after considering the ambient maximum temperature of LEDs.

- (5) Cleaning
 - a. It is recommended that isopropyl alcohol be used as a solvent for cleaning the LEDs. When using other solvents, it should be confirmed beforehand whether the solvents will dissolve the resin or not. Freon solvents should not be used to clean the LEDs because of worldwide regulations.
 - b. Do not clean the LEDs by ultrasonic. When it is absolutely necessary, the influence of ultrasonic cleaning on the LEDs depends on factors such as ultrasonic power and the assembled condition. Before cleaning, a pre-test should be done to confirm whether any damage to the LEDs would occur.

- (6) Safety Guideline for Human Eyes
 - a. In 1993, the International Electric Committee (IEC) issued a standard concerning laser product safety (IEC 825-1). Since then, this standard has been applied for diffused light sources (LEDs) as well as lasers. In 1998 IEC 60825-1 Edition 1.1 evaluated the magnitude of the light source.
 - b. In 2001 IEC 60825-1 Amendment 2 converted the laser class into 7 classes for end products.
 - c. Components are excluded from this system. Products which contain visible LEDs are now classified as class 1. Products containing UV LEDs can be classified as class 2 in cases where viewing angles are narrow, optical manipulation intensifies the light, and/or the energy emitted is high. For these systems it is recommended to avoid long term exposure. It is also recommended to follow the IEC regulations regarding safety and labeling of products.

- (7) Soldering Condition for LED Lamps
 - a. Careful attention should be paid during soldering.
 - b. Solder the LED no closer than 3mm from the base of the epoxy bulb. Soldering beyond the base of the tie bar is recommended.
 - c. Recommended soldering conditions

	Dip Soldering		Soldering
Pre-Heat	120°C Max	Temperature	350°C Max
Pre-Heat Time	60 seconds Max	Soldering Time	3 seconds Max
Solder Bath Temperature	260°C Max	Position	No closer than 3 mm from the base of the epoxy bulb.
Dipping Time	10 seconds Max		
Dipping Position	No lower than 3 mm from the base of the epoxy bulb.		

- d. Do not apply any stress to the lead particularly when heated. The LEDs must not be repositioned after soldering. After soldering the LEDs, the epoxy bulb should be protected from mechanical shock or vibration until the LEDs return to room temperature. Direct soldering onto a PC board should be avoided. Mechanical stress to the resin may be caused from warping of the PC board or from the clinching and cutting of the leadframes. When it is absolutely necessary, the LEDs may be mounted in this fashion but the User will assume responsibility for any problems. Direct soldering should only be done after testing has confirmed that no damage, such as wire bond failure or resin deterioration, will occur. Wah Wang LEDs should not be soldered directly to double sided PC boards because the heat will deteriorate the epoxy resin.
- When it is necessary to clamp the LEDs to prevent soldering failure, it is important to minimize the mechanical stress on the LEDs. Cut the LED leadframes at room temperature. Cutting the leadframes at high temperatures may cause failure of the LEDs.

- (8) Others
 - a. Care must be taken to ensure that the reverse voltage will not exceed the absolute maximum rating when using the LEDs with matrix drive. Keeping the Normal Forward to 20 mA.
 - b. The LEDs described in this brochure are intended to be used for ordinary electronic equipment (such as office equipment, communications equipment, measurement instruments and household appliances). Consult Wah Wang's sales staff in advance for information on the applications in which exceptional quality and reliability are required, particularly when the failure or malfunction of the LEDs may directly jeopardize life or health (such as for airplanes, aerospace, submersible repeaters, nuclear reactor control systems, automobiles, traffic control equipment, life support systems and safety devices).

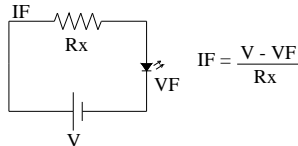

- c. User shall not reverse engineer by disassembling or analysis of the LEDs without having prior written consent from Wah Wang. When defective LEDs are found, the User shall inform Wah Wang directly before disassembling or analysis.
- d. The formal specifications must be exchanged and signed by both parties before large volume purchase begins.
- e. The appearance and specifications of the product may be modified for improvement without notice.