

■Features

- High Luminous LEDs
- 5mm Round Standard Directivity
- Long Lifetime Operation
- Superior Weather-resistance
- UV Resistant Epoxy/ Water Clear Type
- AC LED

■Applications

- Toys
- Audio
- Games
- Other Lighting

■Outline Dimension

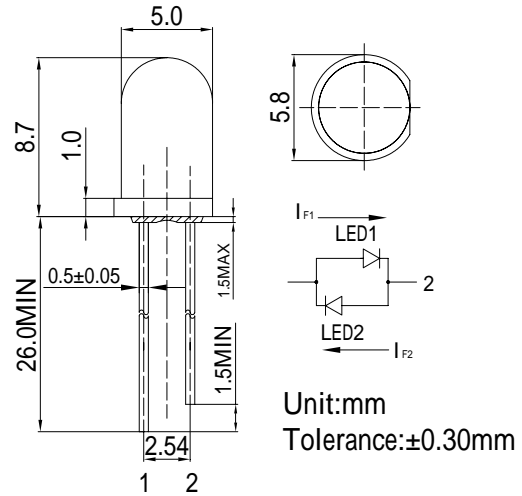

■Absolute Maximum Rating

(Ta=25)

Item	Symbol	Value		Unit
		LED1	LED2	
DC Forward Current	I _F	30	30	mA
Pulse Forward Current*	I _{FP}	100	100	mA
Reverse Voltage	V _R	5	5	V
Power Dissipation	P _D	78	78	mW
Operating Temperature	Topr	-30 ~ +85		
Storage Temperature	Tstg	-40 ~ +100		
Lead Soldering Temperature	Tsol	260 /5sec		-

■Directivity

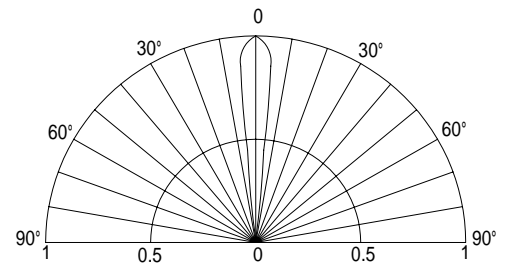

*Pulse width Max.10ms Duty ratio max 1/10

■Electrical -Optical Characteristics

(Ta=25)

Item	NO.	Symbol	Condition	Min.	Typ.	Max.	Unit
DC Forward Voltage	LED1	V _{F1}	I _{F1} =20mA	1.8	2.1	2.6	V
	LED2	V _{F2}	I _{F2} =20mA	1.8	2.1	2.6	V
Domi. Wavelength*	LED1	λ _{D1}	I _{F1} =20mA	600	605	610	nm
	LED2	λ _{D2}	I _{F2} =20mA	600	605	610	nm
Luminous Intensity*	LED1	I _{v1}	I _{F1} =20mA	4200	5800	-	mcd
	LED2	I _{v2}	I _{F2} =20mA	4200	5800	-	mcd
50% Power Angle	LED1	2θ _{1/2}	I _{F1} =20mA	-	15	-	deg
	LED2	2θ _{1/2}	I _{F2} =20mA	-	15	-	deg

*Tolerance of dominant chromaticity is ±10%

*2 Tolerance of luminous intensity is ±15%