

PRODUCT SPECIFICATION

Model No.: FYL-3019RGW1A-CC

Descriptions:
■ Dice material: AlGaInP/ AlGaInP
■ Emitting Color: Red/Yellow green
■ Device Outline: Φ3mm round type.
■ Lens Type: White diffused.



CUSTOMER APPROVED SIGNATURES	APPROVED BY	CHECKED BY	PREPARED BY

NINGBO FORYARD OPTOELECTRONICS CO.,LTD.

Add:NO.115 Qixin Road Ningbo Zhejiang China

Zip:315051

Tel: 0086-574-87933652 87927870 87922206

Fax: 0086-574-87927917

E-mail: Sales@foryard.com (General)

[Http://www.foryard.com](http://www.foryard.com)

■ Features

1. Low power consumption.
2. High efficiency.
3. General purpose leads.
4. RoHs compliant.

■ Package configuration

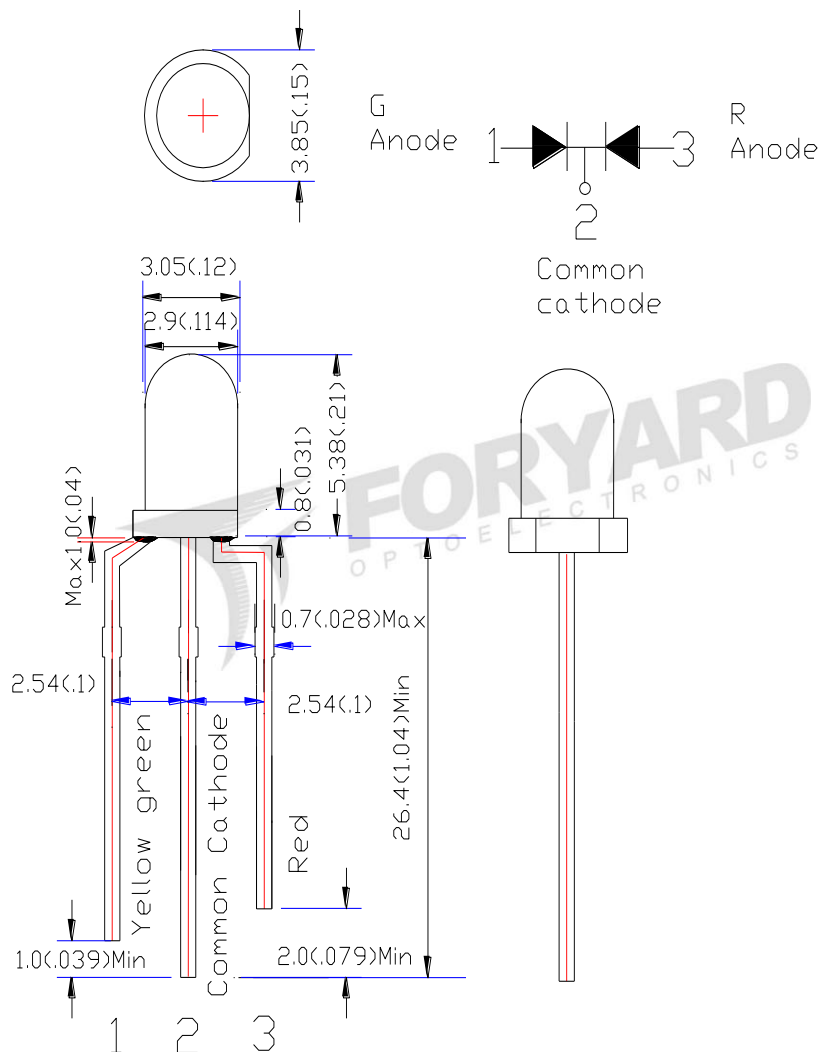

Notes:

1. All dimensions are millimeters (inches)
2. Tolerance is $\pm 0.25\text{mm} (.010\text{'})$ unless otherwise noted.
3. The specifications, characteristics and technical data described in the datasheet are subject to change without prior notice.

■ Absolute maximum ratings(Ta=25 °c)

Parameter	MAX.	Unit
Power Dissipation	R 75	mW
	G 75	
Peak Forward Current (1/10 Duty Cycle, 0.1ms Pulse Width)	100	mA
Continuous Forward Current	30	mA
Derating Linear From 50°C	0.4	mA/°C
Reverse Voltage	5	V
Operating Temperature Range	-40°C to +85°C	
Storage Temperature Range	-40°C to +100°C	
Lead Soldering Temperature[4mm(.157") From Body]	260°C for 5 Seconds	

■ Electrical and optical characteristics(Ta=25 °c)

Parameter	Symbol	Min.	Typ.	Max.	Unit	Test Condition
Luminous Intensity	I _v	R	-	200	-	mcd
		G		100		
Viewing Angle	2θ _{1/2}	R	-	30	-	Deg
		G		30		
Peak Emission Wavelength	λ _p	R	-	640	-	nm
		G	-	568	-	
Dominant Wavelength	λ _d	R	628	630	633	nm
		G	566	570	574	
Spectral Line Half-Width	Δλ	R	10	15	20	nm
		G	15	20	25	
Forward Voltage	V _F	R	1.7	2.0	2.4	V
		G	1.8	2.3	2.5	
Reverse Current	I _R			10	μA	V _R =5V

■ Typical Electrical Characteristics Curves

(25 °c Ambient Temperature Unless Otherwise Noted)

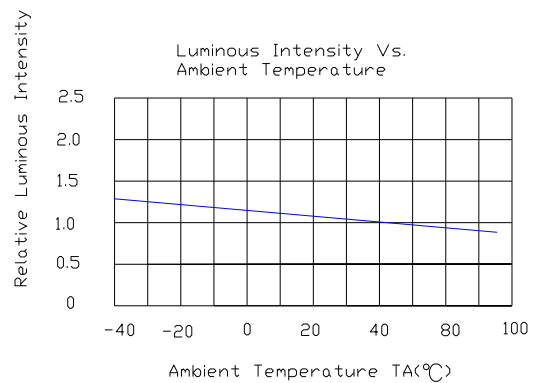
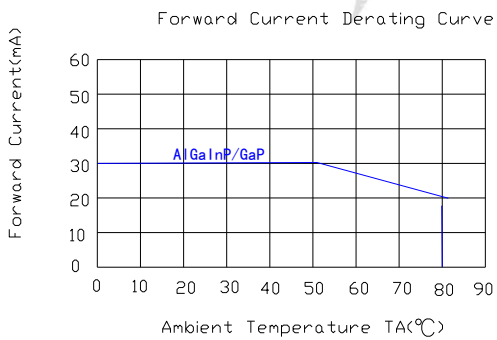
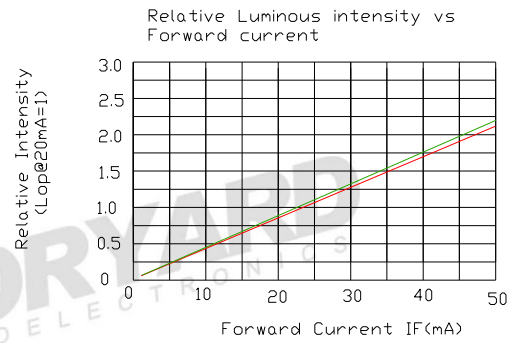
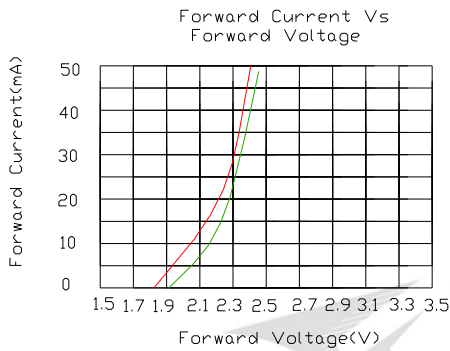
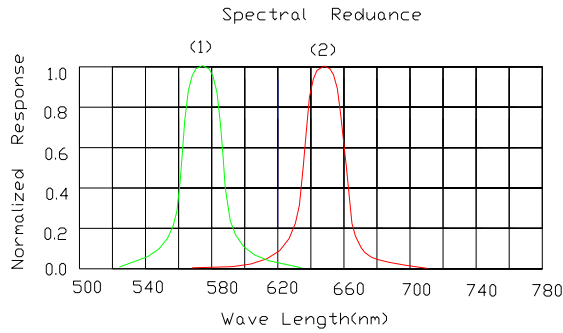

Radiation pattern.

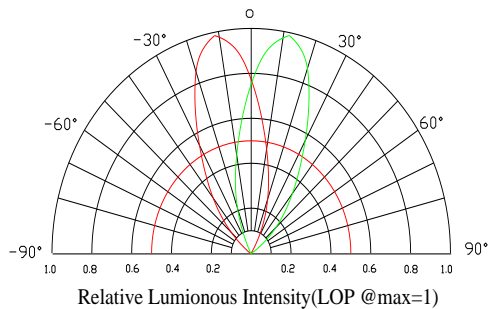

Model. No.	FYL-3019RGW1A-CC
Rev.	A

■ LAMP PACKING.

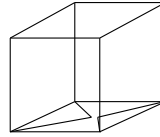
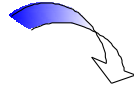
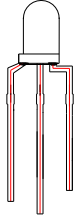

3mm 1000PCS/Polybag

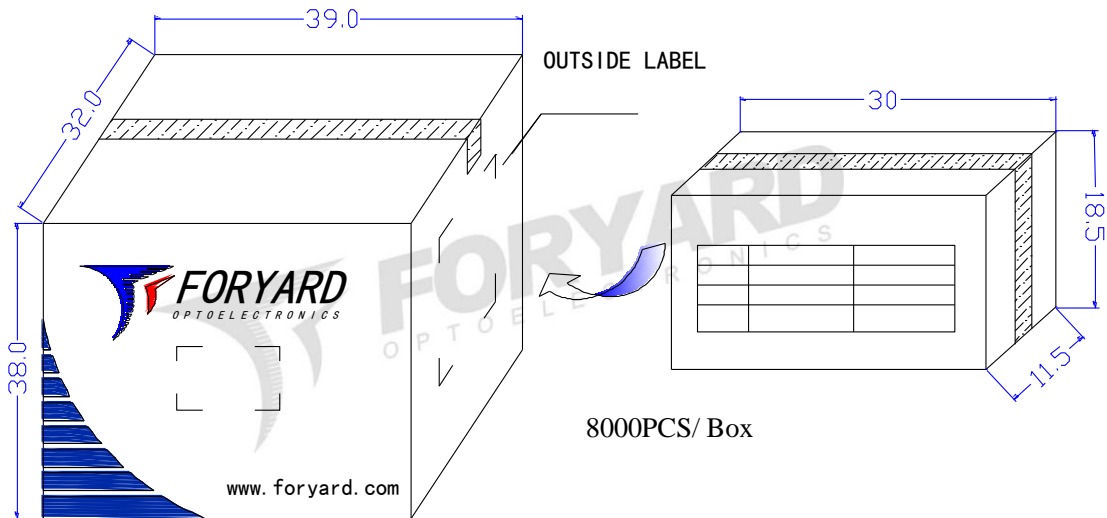
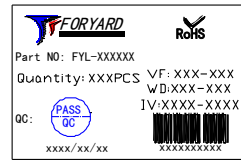

48000PCS/ Carton



OUTSIDE LABEL