

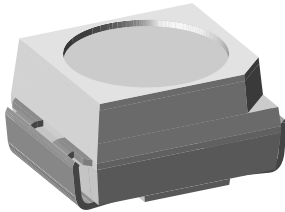

Standard SMD LED PLCC-2



94 8553

FEATURES

- Lead (Pb)-free product-RoHS compliant
- SMD LEDs with exceptional brightness
- Luminous intensity categorized
- Compatible with automatic placement equipment
- EIA and ICE standard package
- Compatible with infrared, vapor phase and wave solder processes according to CECC 00802 and J-STD-020B
- Available in 8 mm tape
- Low profile package
- Non-diffused lens: excellent for coupling to light pipes and backlighting
- Low power consumption
- Luminous intensity ratio in one packaging unit $I_{Vmax}/I_{Vmin} \leq 1.6$
- Preconditioning: acc. to JEDEC level 2a



DESCRIPTION

These devices have been designed to meet the increasing demand for surface mounting technology.

The package of the VLM.310. is the PLCC-2.

It consists of a lead frame which is embedded in a white thermoplast. The reflector inside this package is filled up with clear epoxy.

PRODUCT GROUP AND PACKAGE DATA

- Product group: LED
- Package: SMD PLCC-2
- Product series: standard
- Angle of half intensity: $\pm 60^\circ$

APPLICATIONS

- Automotive: backlighting in dashboards and switches
- Telecommunication: indicator and backlighting in telephone and fax
- Indicator and backlight for audio and video equipment
- Indicator and backlight in office equipment
- Flat backlight for LCDs, switches and symbols
- General use

PARTS TABLE		
PART	COLOR, LUMINOUS INTENSITY	TECHNOLOGY
VLMH3100-GS08	Red, $I_V > 2.8$ mcd	GaAsP on GaP
VLMH3100-GS18	Red, $I_V > 2.8$ mcd	GaAsP on GaP
VLMH3101-GS08	Red, $I_V = (4.5 \text{ to } 11.2)$ mcd	GaAsP on GaP
VLMH3101-GS18	Red, $I_V = (4.5 \text{ to } 11.2)$ mcd	GaAsP on GaP
VLMH3102-GS08	Red, $I_V = (7.1 \text{ to } 18)$ mcd	GaAsP on GaP
VLMH3102-GS18	Red, $I_V = (7.1 \text{ to } 18)$ mcd	GaAsP on GaP
VLMO3100-GS08	Soft orange, $I_V > 2.8$ mcd	GaAsP on GaP
VLMO3100-GS18	Soft orange, $I_V > 2.8$ mcd	GaAsP on GaP
VLMO3101-GS08	Soft orange, $I_V = (4.5 \text{ to } 11.2)$ mcd	GaAsP on GaP
VLMO3101-GS18	Soft orange, $I_V = (4.5 \text{ to } 11.2)$ mcd	GaAsP on GaP
VLMY3100-GS08	Yellow, $I_V > 2.8$ mcd	GaAsP on GaP



PARTS TABLE		
PART	COLOR, LUMINOUS INTENSITY	TECHNOLOGY
VLMY3100-GS18	Yellow, $I_V > 2.8$ mcd	GaAsP on GaP
VLMY3101-GS08	Yellow, $I_V = (4.5 \text{ to } 11.2)$ mcd	GaAsP on GaP
VLMY3101-GS18	Yellow, $I_V = (4.5 \text{ to } 11.2)$ mcd	GaAsP on GaP
VLMY3102-GS08	Yellow, $I_V = (7.1 \text{ to } 18)$ mcd	GaAsP on GaP
VLMY3102-GS18	Yellow, $I_V = (7.1 \text{ to } 18)$ mcd	GaAsP on GaP
VLMG3100-GS08	Green, $I_V > 4.5$ mcd	GaP on GaP
VLMG3100-GS18	Green, $I_V > 4.5$ mcd	GaP on GaP
VLMG3102-GS08	Green, $I_V = (11.2 \text{ to } 18)$ mcd	GaP on GaP
VLMG3102-GS18	Green, $I_V = (11.2 \text{ to } 18)$ mcd	GaP on GaP
VLMG3105-GS08	Green, $I_V = (7.1 \text{ to } 18)$ mcd	GaP on GaP
VLMG3105-GS18	Green, $I_V = (7.1 \text{ to } 18)$ mcd	GaP on GaP
VLMP3100-GS08	Pure green, $I_V > 1.12$ mcd	GaP on GaP
VLMP3100-GS18	Pure green, $I_V > 1.12$ mcd	GaP on GaP
VLMP3101-GS08	Pure green, $I_V = (1.8 \text{ to } 4.5)$ mcd	GaP on GaP
VLMP3101-GS18	Pure green, $I_V = (1.8 \text{ to } 4.5)$ mcd	GaP on GaP
VLMP3107-GS08	Pure green, $I_V = (2.8 \text{ to } 5.6)$ mcd	GaP on GaP
VLMP3107-GS18	Pure green, $I_V = (2.8 \text{ to } 5.6)$ mcd	GaP on GaP
VLMP3102-GS08	Pure green, $I_V = (2.8 \text{ to } 7.1)$ mcd	GaP on GaP
VLMP3102-GS18	Pure green, $I_V = (2.8 \text{ to } 7.1)$ mcd	GaP on GaP

ABSOLUTE MAXIMUM RATINGS ¹⁾ VLMG310. , VLMH310. , VLMO310. , VLMP310. , VLMY310.				
PARAMETER	TEST CONDITION	SYMBOL	VALUE	UNIT
Reverse voltage		V_R	6	V
DC forward current	$T_{amb} \leq 60$ °C	I_F	30	mA
Surge forward current	$t_p \leq 10$ μs	I_{FSM}	0.5	A
Power dissipation	$T_{amb} \leq 60$ °C	P_V	100	mW
Junction temperature		T_j	100	°C
Operating temperature range		T_{amb}	- 40 to + 100	°C
Storage temperature range		T_{stg}	- 40 to + 100	°C
Soldering temperature	$t \leq 5$ s	T_{sd}	260	°C
Thermal resistance junction/ambient	mounted on PC board (pad size > 16 mm ²)	R_{thJA}	400	K/W

Note:

¹⁾ $T_{amb} = 25$ °C, unless otherwise specified

OPTICAL AND ELECTRICAL CHARACTERISTICS ¹⁾ VLMH310., RED							
PARAMETER	TEST CONDITION	PART	SYMBOL	MIN.	TYP.	MAX.	UNIT
Luminous intensity ²⁾	$I_F = 10$ mA	VLMH3100	I_V	2.8	10		mcd
		VLMH3101	I_V	4.5		11.2	mcd
		VLMH3102	I_V	7.1		18	mcd
Dominant wavelength	$I_F = 10$ mA		λ_d	612		625	nm
Peak wavelength	$I_F = 10$ mA		λ_p		635		nm
Angle of half intensity	$I_F = 10$ mA		φ		± 60		deg
Forward voltage	$I_F = 20$ mA		V_F		2	2.8	V
Reverse voltage	$I_R = 10$ μA		V_R	6	15		V
Junction capacitance	$V_R = 0, f = 1$ MHz		C_j		15		pF

Note:

¹⁾ $T_{amb} = 25$ °C, unless otherwise specified

²⁾ In one packing unit $I_{Vmax}/I_{Vmin} \leq 1.6$



OPTICAL AND ELECTRICAL CHARACTERISTICS ¹⁾ VLMO310., SOFT ORANGE							
PARAMETER	TEST CONDITION	PART	SYMBOL	MIN.	TYP.	MAX.	UNIT
Luminous intensity ²⁾	$I_F = 10 \text{ mA}$	VLMO3100	I_V	2.8	8		mcd
		VLMO3101	I_V	4.5		11.2	mcd
Dominant wavelength	$I_F = 10 \text{ mA}$		λ_d	598		611	nm
Peak wavelength	$I_F = 10 \text{ mA}$		λ_p		605		nm
Angle of half intensity	$I_F = 10 \text{ mA}$		ϕ		± 60		deg
Forward voltage	$I_F = 20 \text{ mA}$		V_F		2	2.8	V
Reverse voltage	$I_R = 10 \mu\text{A}$		V_R	6	15		V
Junction capacitance	$V_R = 0, f = 1 \text{ MHz}$		C_j		15		pF

Note:

¹⁾ $T_{amb} = 25 \text{ }^\circ\text{C}$, unless otherwise specified²⁾ In one packing unit $I_{Vmax}/I_{Vmin} \leq 1.6$

OPTICAL AND ELECTRICAL CHARACTERISTICS ¹⁾ VLMY310., YELLOW							
PARAMETER	TEST CONDITION	PART	SYMBOL	MIN.	TYP.	MAX.	UNIT
Luminous intensity ²⁾	$I_F = 10 \text{ mA}$	VLMY3100	I_V	2.8	10		mcd
		VLMY3101	I_V	4.5		11.2	mcd
		VLMY3102	I_V	7.1		18	mcd
Dominant wavelength	$I_F = 10 \text{ mA}$		λ_d	581		594	nm
Peak wavelength	$I_F = 10 \text{ mA}$		λ_p		585		nm
Angle of half intensity	$I_F = 10 \text{ mA}$		ϕ		± 60		deg
Forward voltage	$I_F = 20 \text{ mA}$		V_F		2.1	2.8	V
Reverse voltage	$I_R = 10 \mu\text{A}$		V_R	6	15		V
Junction capacitance	$V_R = 0, f = 1 \text{ MHz}$		C_j		15		pF

Note:

¹⁾ $T_{amb} = 25 \text{ }^\circ\text{C}$, unless otherwise specified²⁾ In one packing unit $I_{Vmax}/I_{Vmin} \leq 1.6$

OPTICAL AND ELECTRICAL CHARACTERISTICS ¹⁾ VLMG310., GREEN							
PARAMETER	TEST CONDITION	PART	SYMBOL	MIN.	TYP.	MAX.	UNIT
Luminous intensity ²⁾	$I_F = 10 \text{ mA}$	VLMG3100	I_V	4.5	16		mcd
		VLMG3102	I_V	11.2		18	mcd
		VLMG3105	I_V	7.1		18	mcd
Dominant wavelength	$I_F = 10 \text{ mA}$		λ_d	562		575	nm
Peak wavelength	$I_F = 10 \text{ mA}$		λ_p		565		nm
Angle of half intensity	$I_F = 10 \text{ mA}$		ϕ		± 60		deg
Forward voltage	$I_F = 20 \text{ mA}$		V_F		2.2	2.8	V
Reverse voltage	$I_R = 10 \mu\text{A}$		V_R	6	15		V
Junction capacitance	$V_R = 0, f = 1 \text{ MHz}$		C_j		15		pF

Note:

¹⁾ $T_{amb} = 25 \text{ }^\circ\text{C}$, unless otherwise specified²⁾ In one packing unit $I_{Vmax}/I_{Vmin} \leq 1.6$



OPTICAL AND ELECTRICAL CHARACTERISTICS ¹⁾ VLMP310., PURE GREEN							
PARAMETER	TEST CONDITION	PART	SYMBOL	MIN.	TYP.	MAX.	UNIT
Luminous intensity ²⁾	$I_F = 10 \text{ mA}$	VLMP3100	I_V	1.12	4		mcd
		VLMP3101	I_V	1.8		4.5	mcd
		VLMP3102	I_V	2.8		7.1	mcd
		VLMP3107	I_V	2.8		5.6	mcd
Dominant wavelength	$I_F = 10 \text{ mA}$		λ_d	555		565	nm
Peak wavelength	$I_F = 10 \text{ mA}$		λ_p		555		nm
Angle of half intensity	$I_F = 10 \text{ mA}$		φ		± 60		deg
Forward voltage	$I_F = 20 \text{ mA}$		V_F		2.1	2.8	V
Reverse voltage	$I_R = 10 \mu\text{A}$		V_R	6	15		V
Junction capacitance	$V_R = 0, f = 1 \text{ MHz}$		C_j		15		pF

Note:

¹⁾ $T_{amb} = 25 \text{ }^\circ\text{C}$, unless otherwise specified

²⁾ In one packing unit $I_{Vmax}/I_{Vmin} \leq 1.6$

COLOR CLASSIFICATION								
GROUP	YELLOW		GREEN		SOFTORANGE		PURE GREEN	
	DOM. WAVELENGTH (nm)				DOM. WAVELENGTH (nm)			
	MIN.	MAX.	MIN.	MAX.	MIN.	MAX.	MIN.	MAX.
0							555	559
1	581	584			598	601	558	561
2	583	586			600	603	560	563
3	585	588			602	605	562	565
4	587	590	564	567	604	607		
5	589	592	566	569	606	609		
6	591	594	568	571	608	611		
7			570	573	606	609		
8			572	575	608	611		

LUMINOUS INTENSITY CLASSIFICATION			
GROUP	LIGHT INTENSITY (mcd)		
	STANDARD	OPTIONAL	MAX.
F	-	-	-
	2	1.40	1.80
G	1	1.80	2.24
	2	2.24	2.80
H	1	2.80	3.55
	2	3.55	4.50
J	1	4.50	5.60
	2	5.60	7.10
K	1	7.10	9.00
	2	9.00	11.20
L	1	11.20	14.00
	2	14.00	18.00
M	1	18.00	22.40
	2	22.40	28.00

Note:

Luminous intensity is tested at a current pulse duration of 25 ms and an accuracy of $\pm 11 \%$.

The above Type Numbers represent the order groups which include only a few brightness groups. Only one group will be shipped on each reel (there will be no mixing of two groups on each reel).

In order to ensure availability, single brightness groups will not be orderable.

In a similar manner for colors where wavelength groups are measured and binned, single wavelength groups will be shipped on any one reel.

In order to ensure availability, single wavelength groups will not be orderable.



CROSSING TABLE		
VISHAY	OSRAM	STANLEY
VLMH3100	-	-
VLMH3101	-	-
VLMH3102	-	-
VLMO3100	LOT670J1L2	-
VLMO3101	LOT670J1K2	-
VLMY3100	LYT670J1L2	-
VLMY3101	LYT670J1K2	-
VLMY3102	LYT670K1L2	-
VLMG3100	LGT670K1M2	VYBG1104B
VLMG3102	LGT670L1L2	-
VLMG3105	LGT671K1L2	-
VLMP3100	LPT670F2J2	-
VLMP3101	LPT670G1H2	VYBG1101W
VLMP3102	LPT670H1J2	-
VLMP3107	LPT670H1J1	-

TYPICAL CHARACTERISTICS

T_{amb} = 25 °C, unless otherwise specified

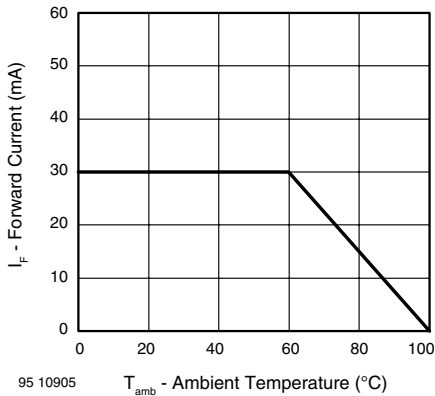

Figure 1. Maximum Permissible Forward Current vs. Ambient Temperature

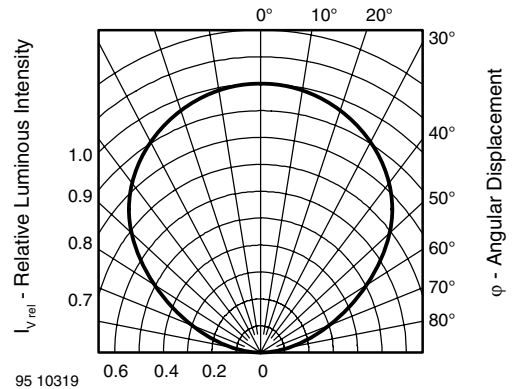

Figure 3. Relative Luminous Intensity vs. Angular Displacement

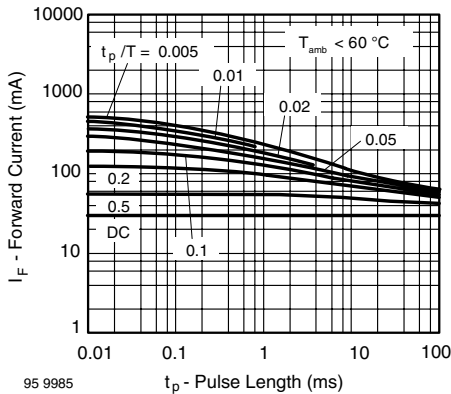

Figure 2. Permissible Pulse Forward Current vs. Pulse Duration

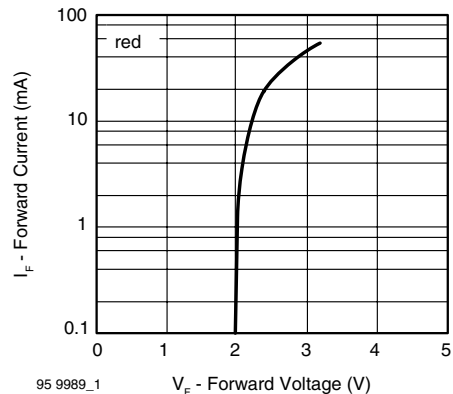

Figure 4. Forward Current vs. Forward Voltage

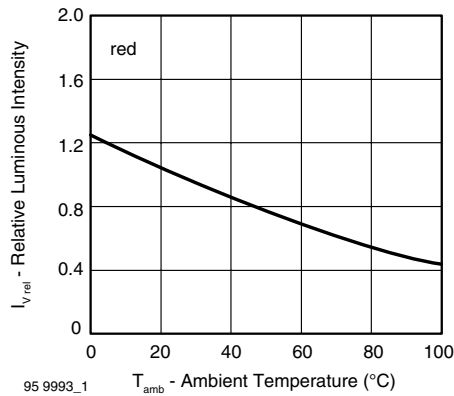

Figure 5. Relative Luminous Intensity vs. Ambient Temperature

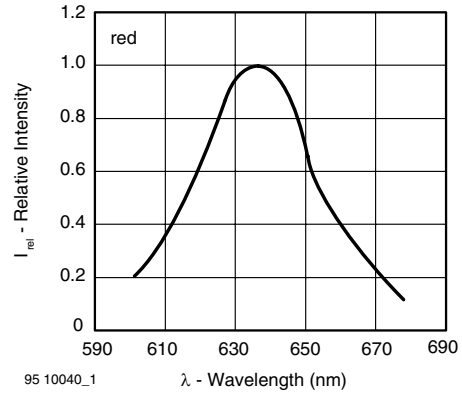

Figure 8. Relative Intensity vs. Wavelength

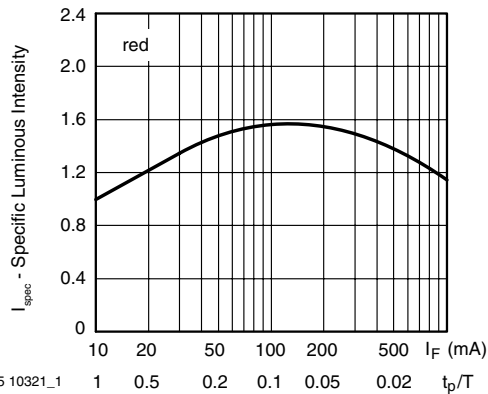

Figure 6. Spec. Luminous Intensity vs. Forw. Current/Duty Cycle

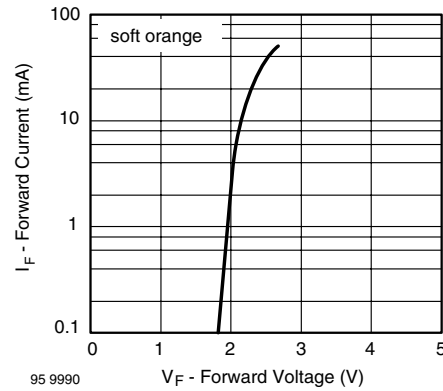

Figure 9. Forward Current vs. Forward Voltage

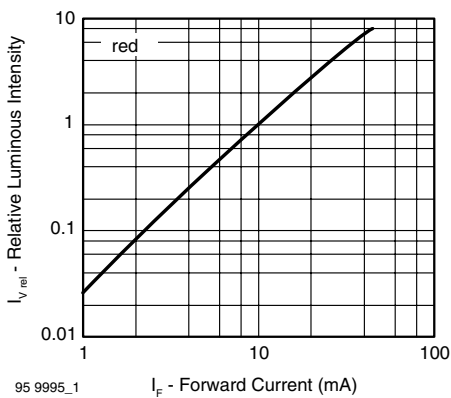

Figure 7. Relative Luminous Intensity vs. Forward Current

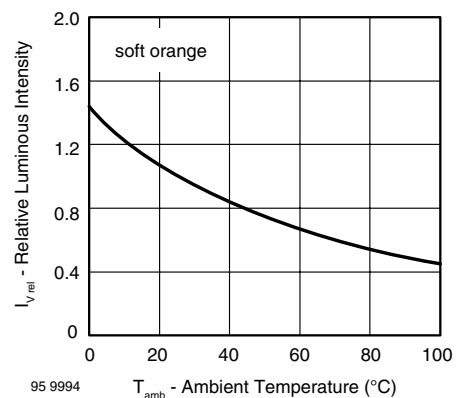

Figure 10. Relative Luminous Intensity vs. Ambient Temperature

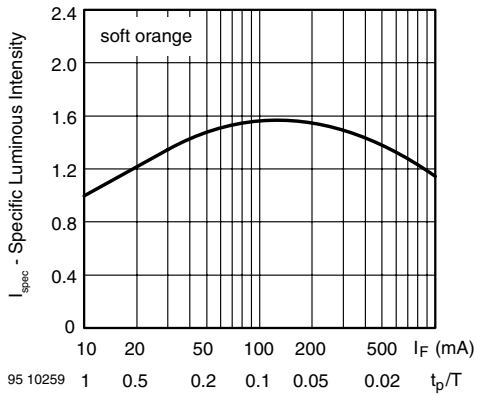

Figure 11. Specific Luminous Intensity vs. Forw. Current/Duty Cycle

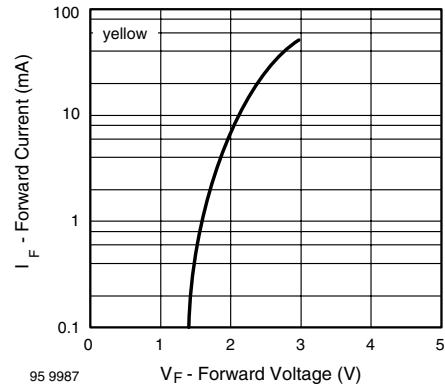

Figure 14. Forward Current vs. Forward Voltage

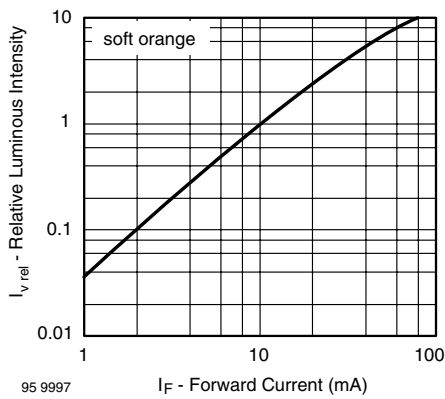

Figure 12. Relative Luminous Intensity vs. Forward Current

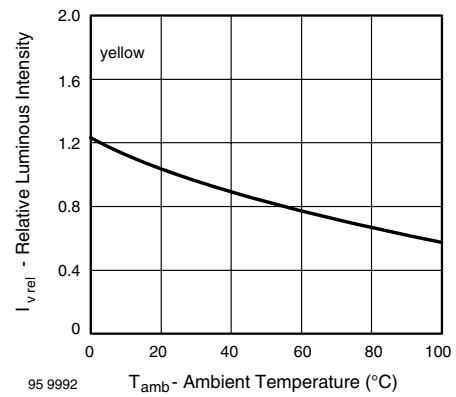

Figure 15. Relative Luminous Intensity vs. Ambient Temperature

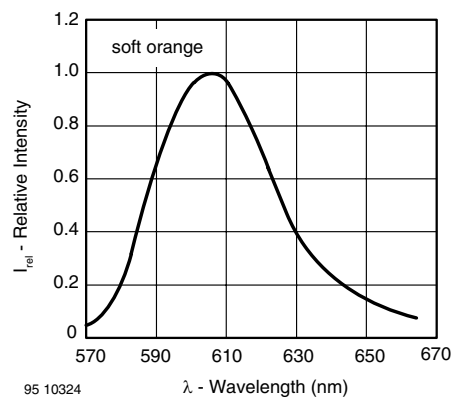

Figure 13. Relative Intensity vs. Wavelength

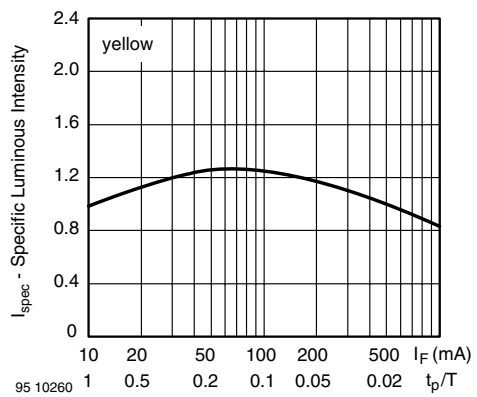

Figure 16. Specific Luminous Intensity vs. Forw. Current/Duty Cycle

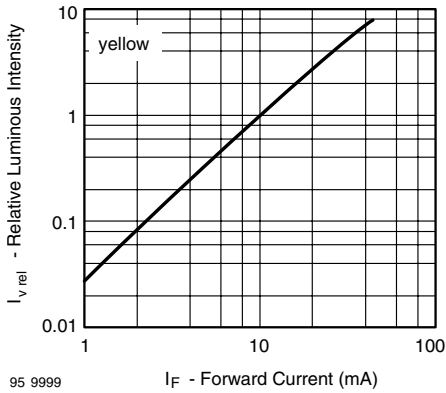

Figure 17. Relative Luminous Intensity vs. Forward Current

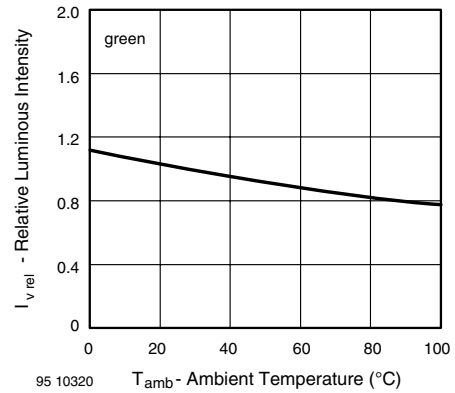

Figure 20. Relative Luminous Intensity vs. Ambient Temperature

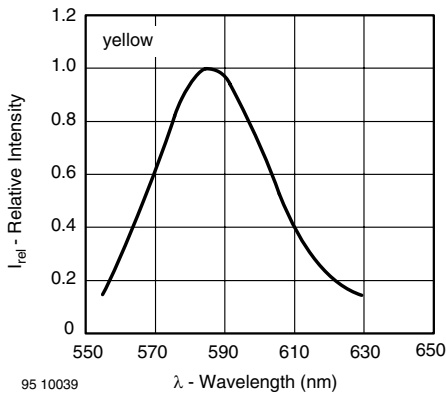

Figure 18. Relative Intensity vs. Wavelength

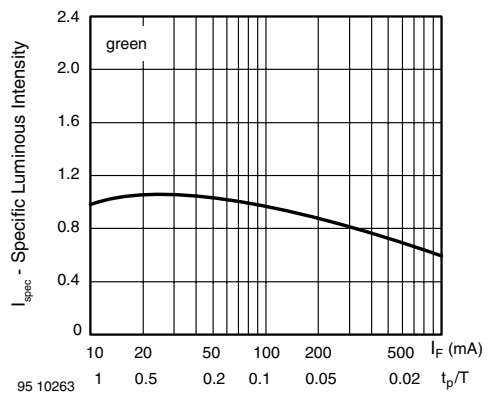

Figure 21. Specific Luminous Intensity vs. Forward Current

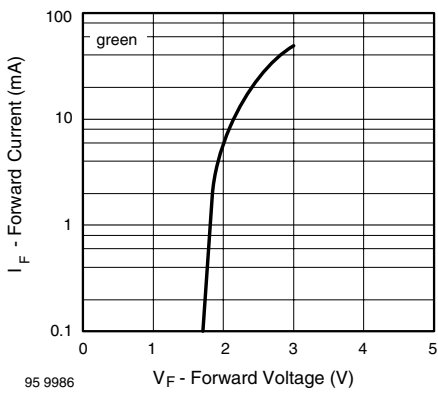

Figure 19. Forward Current vs. Forward Voltage

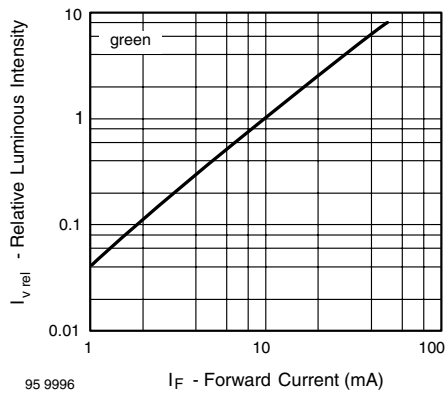

Figure 22. Relative Luminous Intensity vs. Forward Current

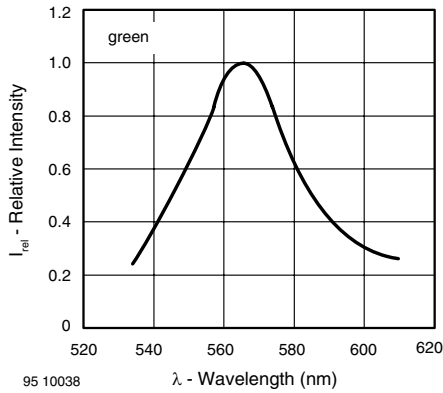

Figure 23. Relative Intensity vs. Wavelength

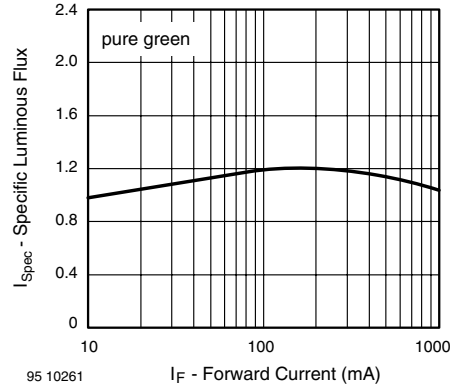

Figure 26. Specific Luminous Intensity vs. Forward Current

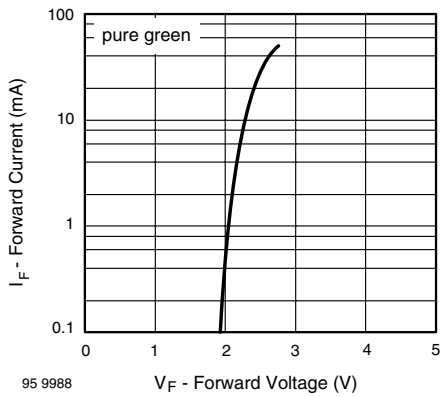

Figure 24. Forward Current vs. Forward Voltage

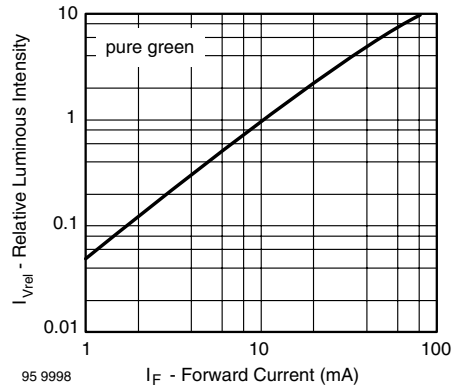

Figure 27. Relative Luminous Intensity vs. Forward Current

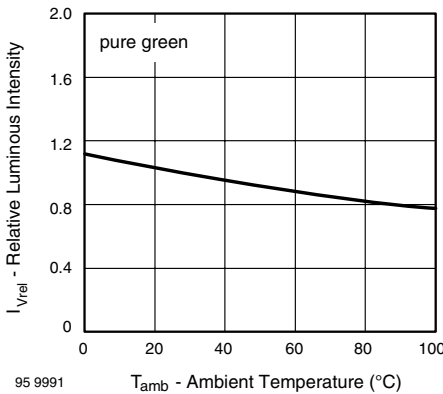

Figure 25. Relative Luminous Intensity vs. Ambient Temperature

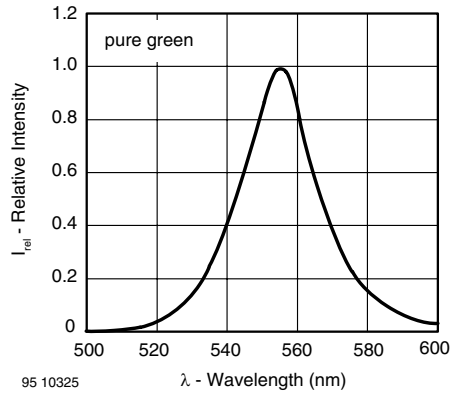
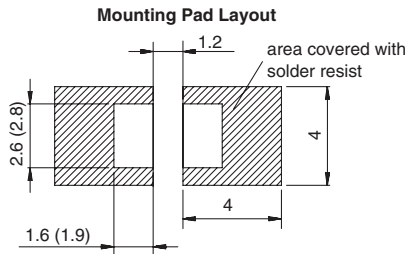
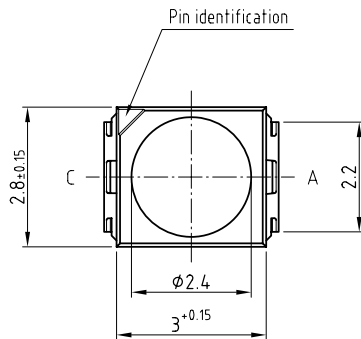
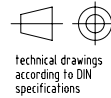
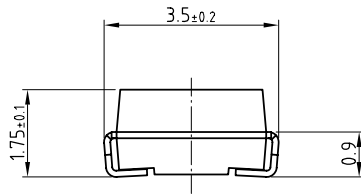

Figure 28. Relative Intensity vs. Wavelength

PACKAGE DIMENSIONS in millimeters



Drawing-No.: 6.541-5067.01-4
 Issue: 4; 30.07.07
 20541

METHOD OF TAPING/POLARITY AND TAPE AND REEL

SMD LED (VLM3-SERIES)

Vishay's LEDs in SMD packages are available in an antistatic 8 mm blister tape (in accordance with DIN IEC 40 (CO) 564) for automatic component insertion. The blister tape is a plastic strip with impressed component cavities, covered by a top tape.

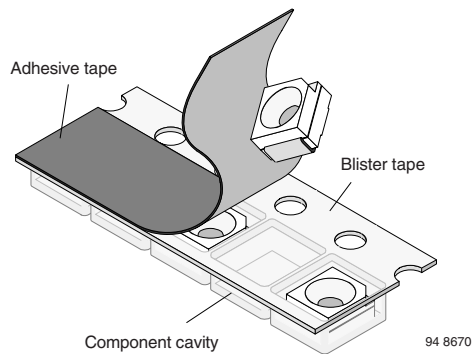

TAPING OF VLM.3..

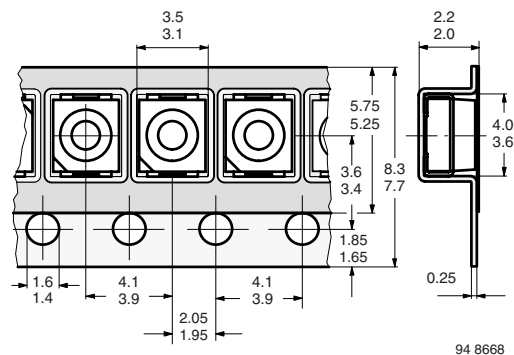

Figure 29. Tape Dimensions in mm for PLCC-2



**REEL PACKAGE DIMENSION IN MM
FOR SMD LEDs, TAPE OPTION GS08
(= 1500 PCS.)**

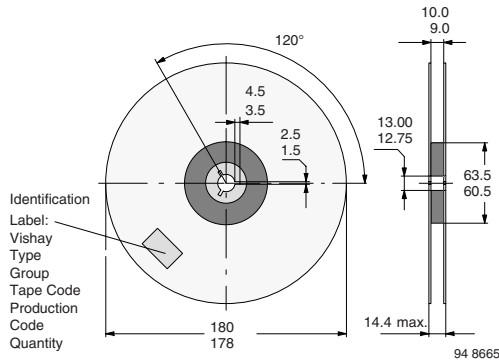

Figure 30. Reel Dimensions - GS08

**REEL PACKAGE DIMENSION IN MM
FOR SMD LEDs, TAPE OPTION GS18
(= 8000 PCS.) PREFERRED**

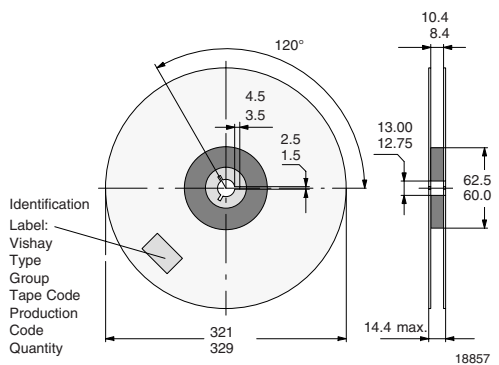

Figure 31. Reel Dimensions - GS18

SOLDERING PROFILE

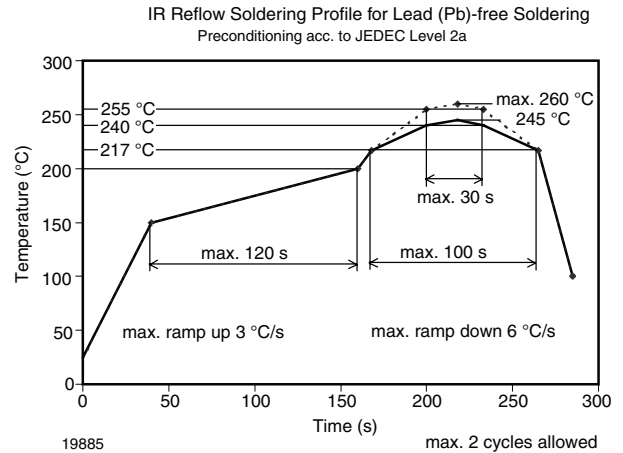

Figure 32. Vishay Lead (Pb)-free Reflow Soldering Profile (acc. to J-STD-020B)

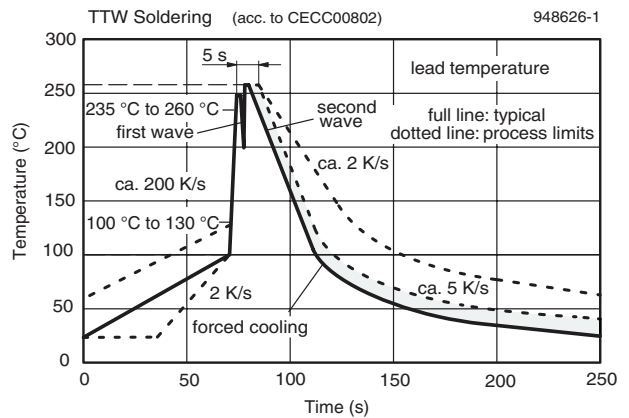
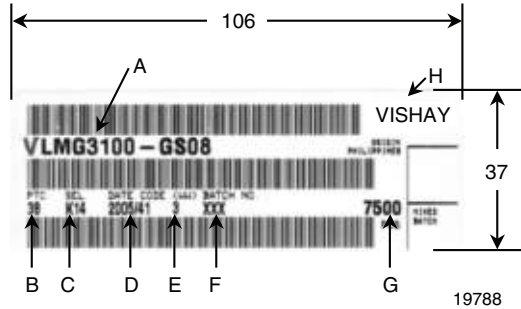

Figure 33. Double Wave Soldering of Opto Devices (all Packages)

**BAR CODE PRODUCT LABEL
EXAMPLE:**



- A) Type of component
- B) Manufacturing plant
- C) SEL - selection code (bin):
e.g.: K1 = code for luminous intensity group
4 = code for color group
- D) Date code year/week
- E) Day code (e.g. 2: Tuesday)
- F) Batch no.
- G) Total quantity
- H) Company code

DRY PACKING

The reel is packed in an anti-humidity bag to protect the devices from absorbing moisture during transportation and storage.

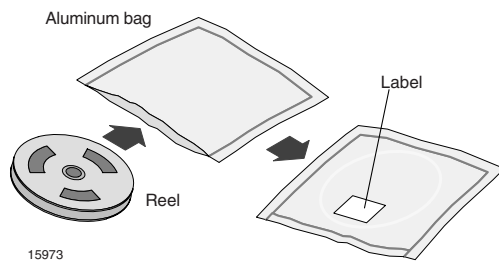

FINAL PACKING

The sealed reel is packed into a cardboard box. A secondary cardboard box is used for shipping purposes.

RECOMMENDED METHOD OF STORAGE

Dry box storage is recommended as soon as the aluminum bag has been opened to prevent moisture absorption. The following conditions should be observed, if dry boxes are not available:

- Storage temperature 10 °C to 30 °C
- Storage humidity ≤ 60 % RH max.

After more than 672 h under these conditions moisture content will be too high for reflow soldering.

In case of moisture absorption, the devices will recover to the former condition by drying under the following condition:

- 192 h at 40 °C + 5 °C/- 0 °C and < 5 % RH (dry air/nitrogen) or
- 96 h at 60 °C + 5 °C and < 5 % RH for all device containers or
- 24 h at 100 °C + 5 °C not suitable for reel or tubes.

An EIA JEDEC standard JESD22-A112 level 2a label is included on all dry bags.

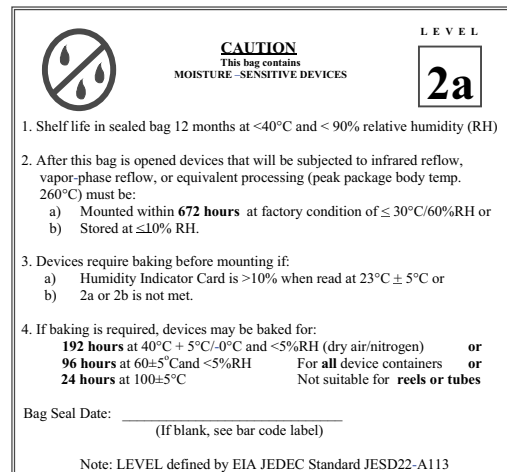

Example of JESD22-A112 level 2a label

ESD PRECAUTION

Proper storage and handling procedures should be followed to prevent ESD damage to the devices especially when they are removed from the antistatic shielding bag. Electro-static sensitive devices warning labels are on the packaging.

**VISHAY SEMICONDUCTORS STANDARD
BAR CODE LABELS**

The Vishay Semiconductors standard bar code labels are printed at final packing areas. The labels are on each packing unit and contain Vishay Semiconductors specific data.



Ozone Depleting Substances Policy Statement

It is the policy of Vishay Semiconductor GmbH to

1. Meet all present and future national and international statutory requirements.
2. Regularly and continuously improve the performance of our products, processes, distribution and operating systems with respect to their impact on the health and safety of our employees and the public, as well as their impact on the environment.

It is particular concern to control or eliminate releases of those substances into the atmosphere which are known as ozone depleting substances (ODSs).

The Montreal Protocol (1987) and its London Amendments (1990) intend to severely restrict the use of ODSs and forbid their use within the next ten years. Various national and international initiatives are pressing for an earlier ban on these substances.

Vishay Semiconductor GmbH has been able to use its policy of continuous improvements to eliminate the use of ODSs listed in the following documents.

1. Annex A, B and list of transitional substances of the Montreal Protocol and the London Amendments respectively.
2. Class I and II ozone depleting substances in the Clean Air Act Amendments of 1990 by the Environmental Protection Agency (EPA) in the USA.
3. Council Decision 88/540/EEC and 91/690/EEC Annex A, B and C (transitional substances) respectively.

Vishay Semiconductor GmbH can certify that our semiconductors are not manufactured with ozone depleting substances and do not contain such substances.

We reserve the right to make changes to improve technical design
and may do so without further notice.

Parameters can vary in different applications. All operating parameters must be validated for each customer application by the customer. Should the buyer use Vishay Semiconductors products for any unintended or unauthorized application, the buyer shall indemnify Vishay Semiconductors against all claims, costs, damages, and expenses, arising out of, directly or indirectly, any claim of personal damage, injury or death associated with such unintended or unauthorized use.

Vishay Semiconductor GmbH, P.O.B. 3535, D-74025 Heilbronn, Germany



Disclaimer

All product specifications and data are subject to change without notice.

Vishay Intertechnology, Inc., its affiliates, agents, and employees, and all persons acting on its or their behalf (collectively, "Vishay"), disclaim any and all liability for any errors, inaccuracies or incompleteness contained herein or in any other disclosure relating to any product.

Vishay disclaims any and all liability arising out of the use or application of any product described herein or of any information provided herein to the maximum extent permitted by law. The product specifications do not expand or otherwise modify Vishay's terms and conditions of purchase, including but not limited to the warranty expressed therein, which apply to these products.

No license, express or implied, by estoppel or otherwise, to any intellectual property rights is granted by this document or by any conduct of Vishay.

The products shown herein are not designed for use in medical, life-saving, or life-sustaining applications unless otherwise expressly indicated. Customers using or selling Vishay products not expressly indicated for use in such applications do so entirely at their own risk and agree to fully indemnify Vishay for any damages arising or resulting from such use or sale. Please contact authorized Vishay personnel to obtain written terms and conditions regarding products designed for such applications.

Product names and markings noted herein may be trademarks of their respective owners.