

**■Features**

- Top view white LED (5.6x3.0x0.8mm)
- Super high brightness of surface mount LED
- Lead frame package with individual 4 pins
- ESD protection
- Compatible to IR reflow soldering.
- MSL:Level 5a

**■Applications**

- General lighting
- Decoration lighting
- Indicator

**■Absolute Maximum Rating**

(Ta=25°C)

Item	Symbo l	Value		Unit
		W/M/B/PG	Y/O/R	
DC Forward Current	IF	150	150	mA
Pulse Forward Current*	IFP	200	200	mA
Reverse Voltage	VR	5	5	V
Power Dissipation	PD	540	390	mW
Operating Temperature	Topr	-30 ~ +85		°C
Storage Temperature	Tstg	-40~ +100		°C
Lead Soldering Temperature	Tsol	260°C/10sec		-

\*Pulse width Max 0.1ms, Duty ratio max 1/10

**■Electrical -Optical Characteristics**

(Ta=25°C)

Part Number	Color		VF (V)			IR(μA)	Φv(lm)			CCT/WD(WP)			2θ1/2(deg)	CRI
			Min.	Typ.	Max.	Max.	Min.	Typ.	Max.	Min.	Typ.	Max.	Typ.	Min.
			IF=150mA			VR=5V	IF=150mA							
OSW55630C1D	Cool White	W	2.8	3.1	3.6	10	40	-	55	8000K	-	16000K	120	70
OSW45630C1D	White	W	2.8	3.1	3.6	10	45	-	60	6000K	-	7000K	120	75
OSW35630C1D	White	W	2.8	3.1	3.6	10	45	-	60	5000K	-	6000K	120	80
OSM75630C1D	Warm White	M	2.8	3.1	3.6	10	45	-	55	3500K	-	4500K	120	80
OSM55630C1D	Warm White	M	2.8	3.1	3.6	10	40	-	55	2800K	-	3500K	120	80
OSB55630C1D	Blue	B	2.8	3.1	3.6	10	5	-	10	455	465	470	120	-
OSG55630C1D	Pure Green	PG	2.8	3.1	3.6	10	25	-	35	520	525	530	120	-
OSY55630C1D	Yellow	Y	1.8	2.1	2.6	10	10	-	20	585	590	595	120	-
OSO55630C1D	Orange	O	1.8	2.1	2.6	10	10	-	20	600	605	610	120	-
OSR55630C1D	Red	R	1.8	2.1	2.6	10	10	-	20	620	625	630	120	-
OSR75630C1D	Red	R	1.8	2.1	2.6	10	5	-	8	650	660	670	120	-

\*1 Tolerance of measurements of chromaticity coordinate is ±10%

\*2 Tolerance of measurements of dominant(peak) wavelength is ±1nm

\*3 Tolerance of measurements of luminous flux is ±15%

\*4 Tolerance of measurements of forward voltage is ±0.1V

**■Outline Dimension**

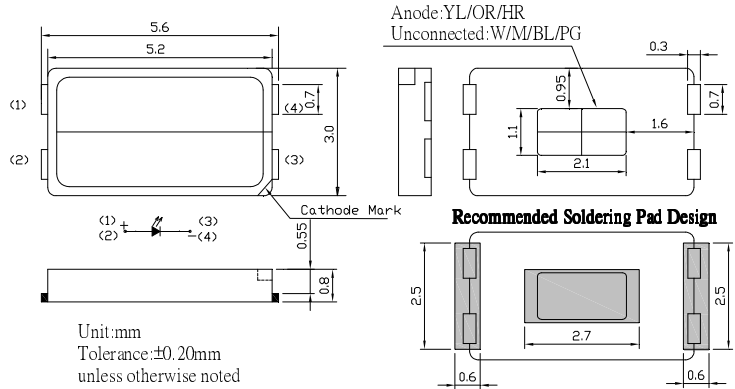

**Recommended Soldering Pad Design**

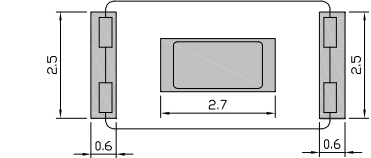

**■Directivity**

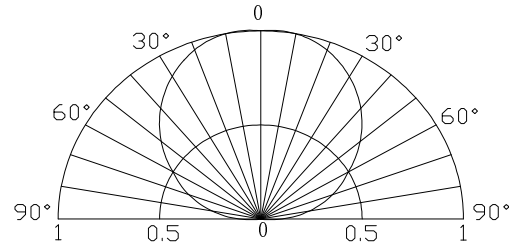

**InGaN AND AlInGaP LED**

**TYPICAL ELECTRICAL/OPTICAL CHARACTERISTIC CURVES**

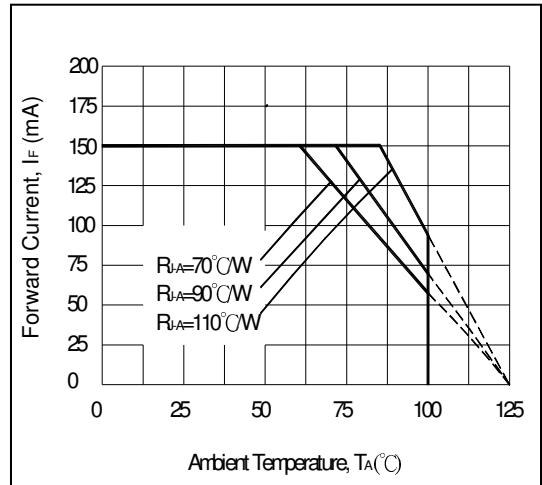
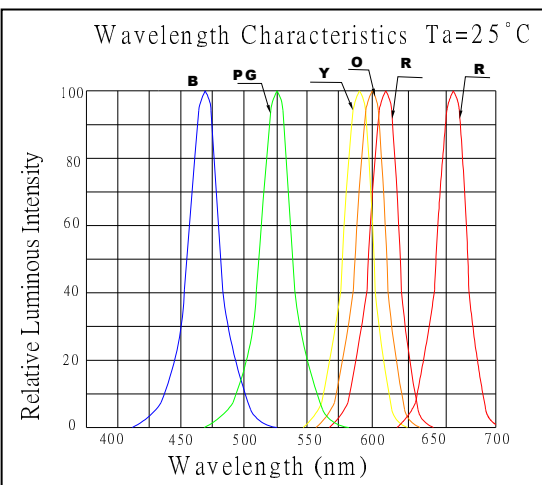
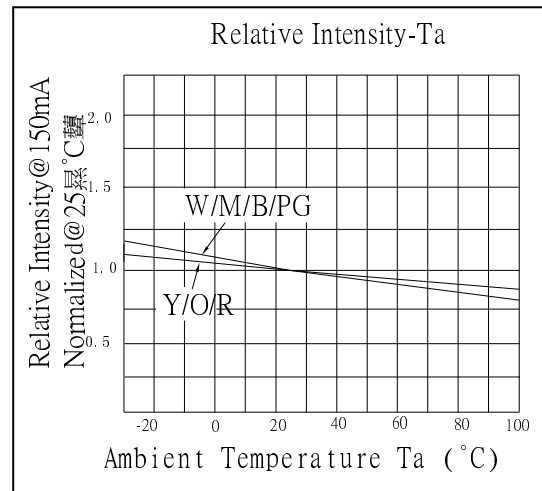
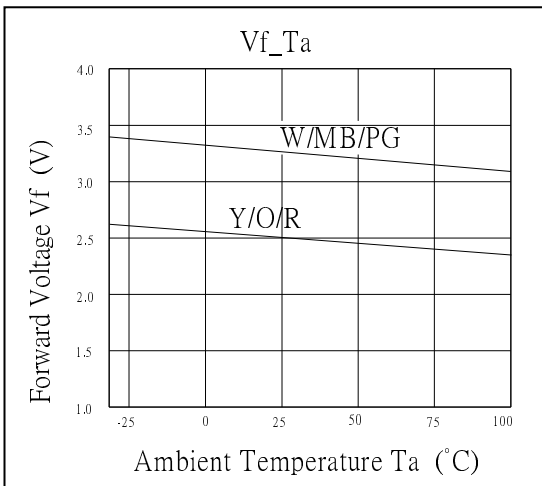
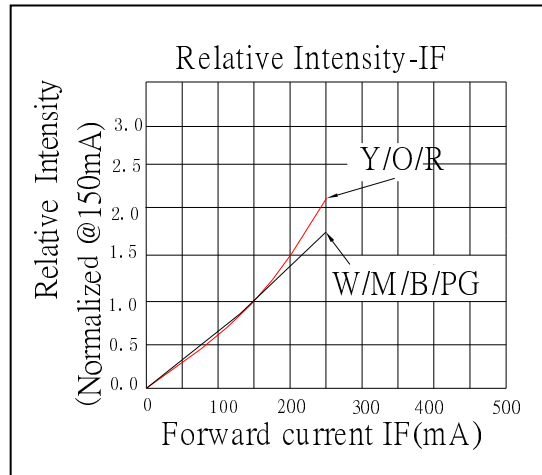
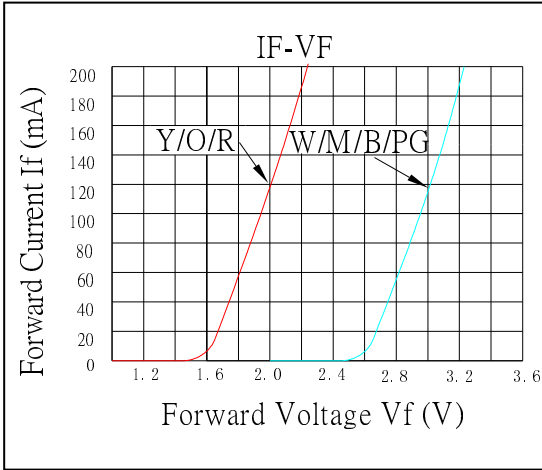

■ Rank

\* Correspondence Table of Luminous Flux (IF=150mA)

Bin code	Flux(lm)	
	Min	Max
1	30	35
2	35	40
3	40	45
4	45	50
5	50	55
6	55	60
.....	.....	.....

\* Correspondence Table of Luminous Flux (IF=65mA)

Bin Code	Flux (lm)	
	Min	Max
1	17	19
2	19	22
3	22	25
4	25	29
5	29	33
6	33	37

\*VF bin Limit (IF=150mA)

Bin code	Min(V)	Max(V)
A	2.8	3.0
B	3.0	3.2
C	3.2	3.4
D	3.4	3.6

■ Chromaticity Diagram

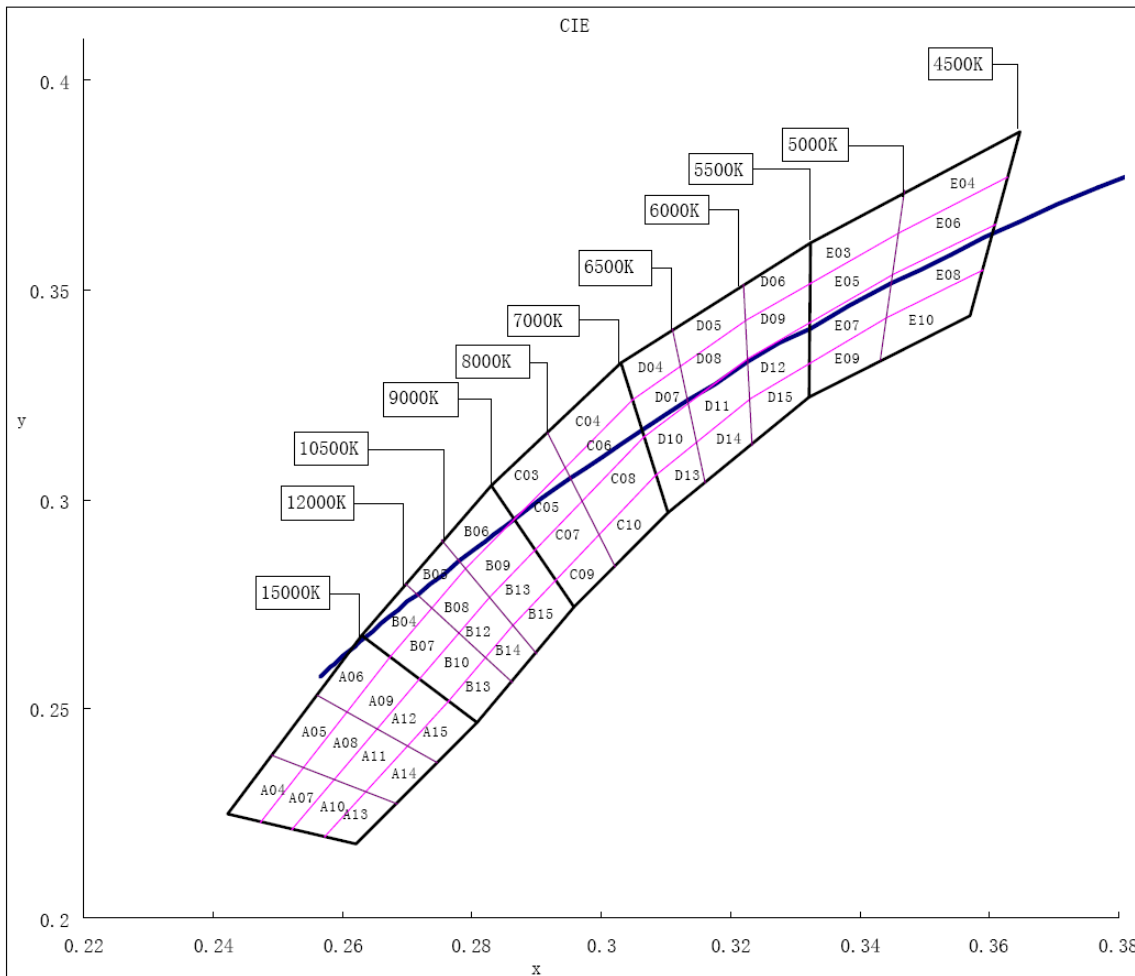

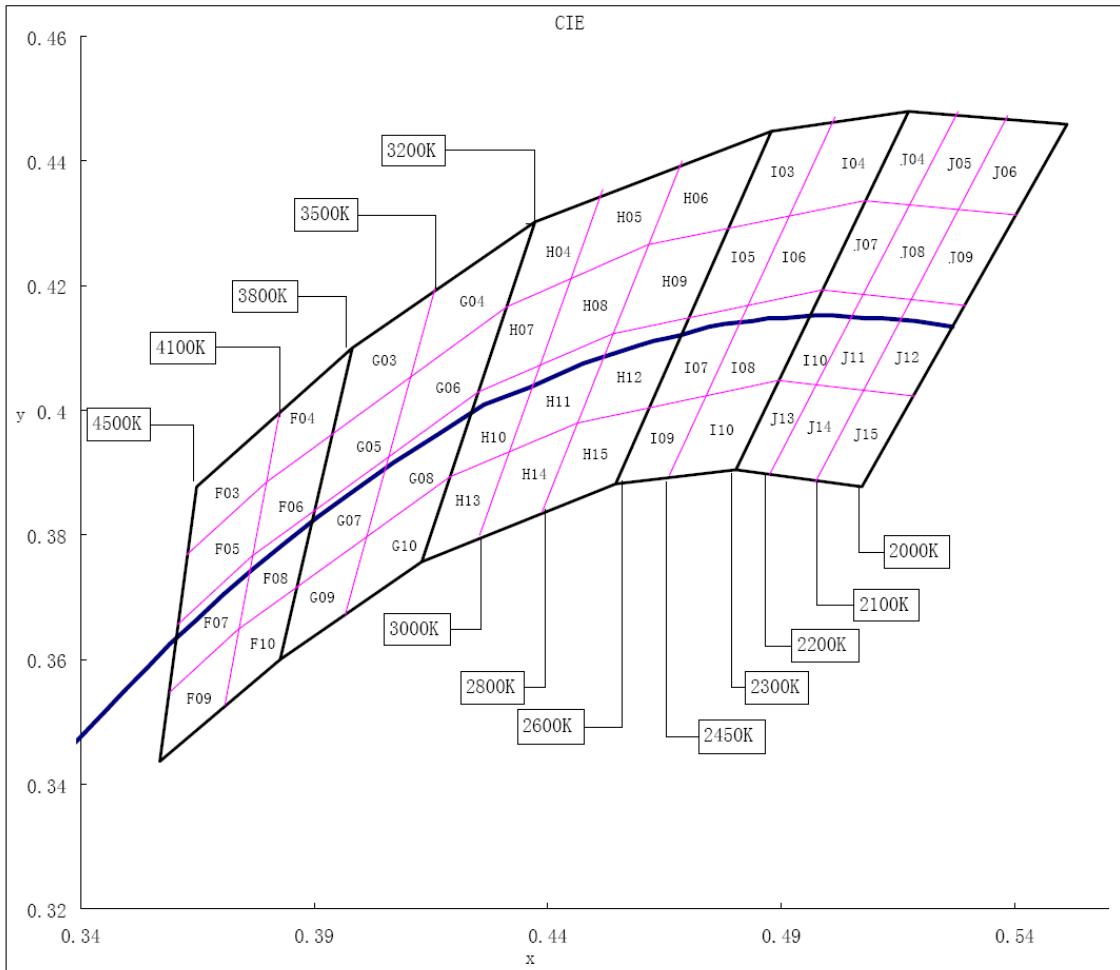

\*Color coordinate is derived from the CIE 1931 chromaticity.

■ Rank

\* Correspondence Table of Luminous Flux (IF=150mA)

Bin Code	Flux (lm)	
	Min	Max
A1	5	10
A2	10	15
A3	15	20
B1	20	25
B2	25	30
1	30	35

\*VF bin Limit (IF=150mA) ( BL/PG)

Bin code	Min (V)	Max(V)
88	2.8	3.0
99	3.0	3.2
AA	3.2	3.4
BB	3.4	3.6

\*VF bin Limit (IF=150mA) ( YL/HR)

Bin code	Min (V)	Max(V)
33	1.8	2.0
44	2.0	2.2
55	2.2	2.4
66	2.4	2.6

\*WD bin Limit (IF=150mA)

W5	1	2	3	-
	8000-10000K	10000-12000K	12000-16000K	-
W4	1	2	-	-
	6000-6500K	6500-7000K	-	-
W3	1	2	-	-
	5000-5500K	5500-6000K	-	-
M7	1	2	-	-
	3500-4000K	4000-4500K	-	-
M5	1	2	3	-
	2800-3000K	3000-3200K	3200-3500K	-
B5	1	2	3	-
	455-460nm	460-465nm	465-470nm	-
G5	1	2	3	4
	520-522.5nm	522.5-525nm	525-527.5nm	527.5-530nm
Y5	1	2	3	4
	585-587.5nm	587.5-590nm	590-592.5nm	592.5-595nm
O5	1	2	3	4
	600-602.5nm	602.5-605nm	605-607.5nm	607.5-610nm
R5	1	2	-	-
	620-625nm	625-630nm	-	-
R7	1	2	-	-
	650-660nm	660-670nm	-	-

■ **Soldering Conditions**

Reflow Soldering		Hand Soldering	
Pre-Heat	180 ~ 200°C	Temperature Soldering time	350°C Max. 3 sec. Max. (one time only)
Pre-Heat Time	120 sec. Max.		
Peak temperature	260°C Max.		
Dipping Time	10 sec. Max.		
Condition	Refer to Temperature-profile		

• **Reflow Soldering Condition(Lead-free Solder)**

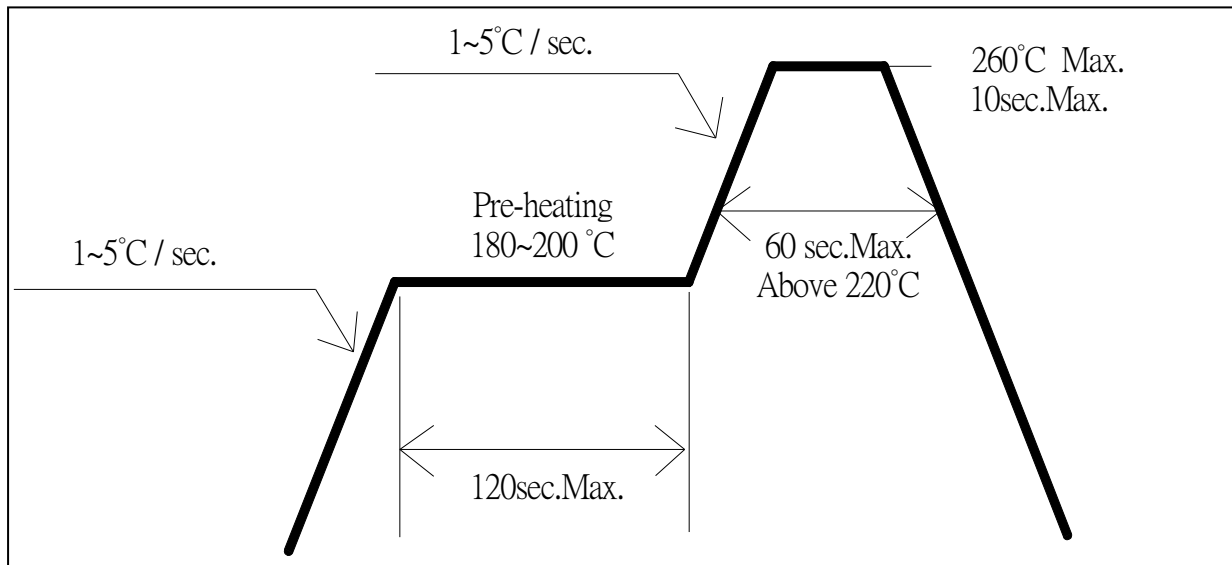

\*Recommended soldering conditions vary according to the type of LED

\*Although the recommended soldering conditions are specified in the above table, reflow, or hand soldering at the lowest possible temperature is desirable for the LEDs.

\*A rapid-rate process is not recommended for cooling the LEDs down from the peak temperature.

• All SMD LED products are pb-free soldering available.

• Occasionally there is a brightness decrease caused by the influence of heat or ambient atmosphere during air reflow. It is recommended that the User use the nitrogen reflow method.

• Repairing should not be done after the LEDs have been soldered. When repairing is unavoidable a double-head soldering iron should be used. It should be confirmed beforehand whether the characteristics of the LEDs will or will not be damaged by repairing.

• Reflow soldering should not be done more than two times.

• When soldering, do not put stress on the LEDs during heating.

• After soldering, do not warp the circuit board.

**■ Package Model**

**Loaded Quantity 3000 pcs. Per Reel**

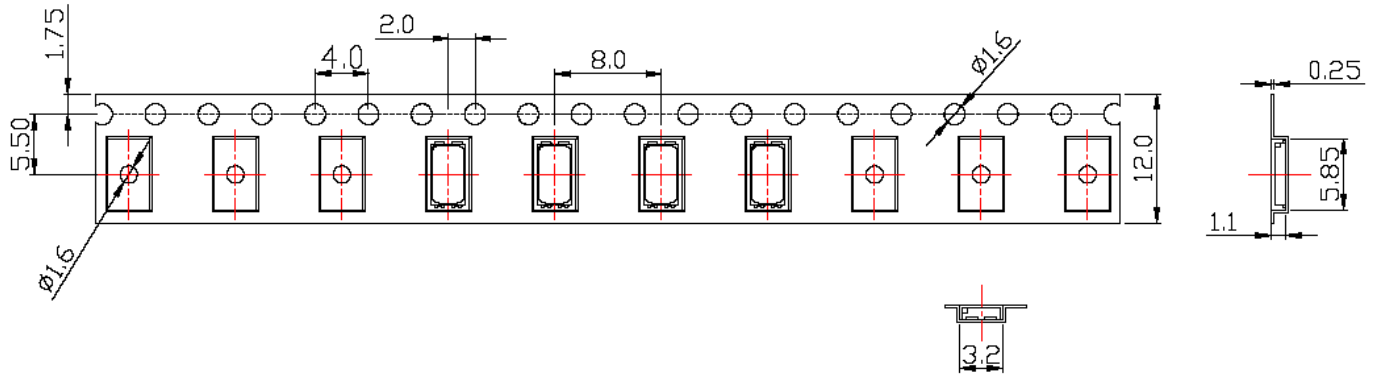

**Reel Part**

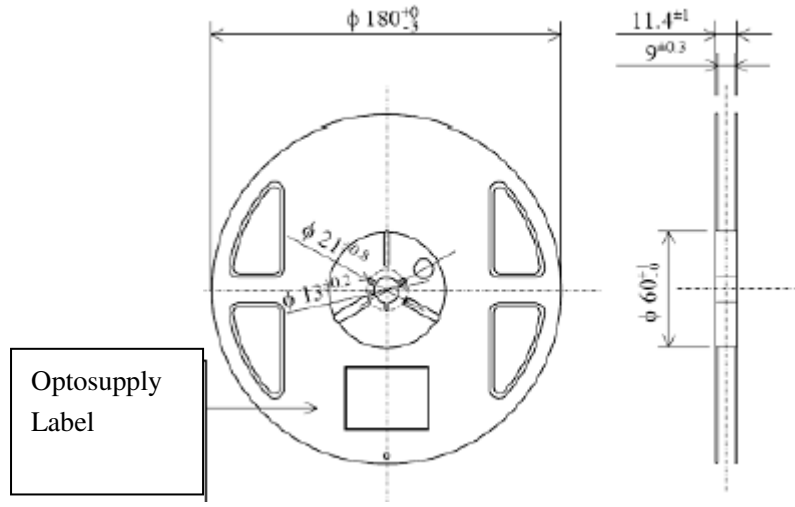

Optosupply  
Label