

0.8mm Height 0603 Package  
Super Bright Red Chip LED  
Technical Data Sheet

Part No :LL-S190SC-2S



## Features

- ◇ Package in 8mm tape on 7" diameter reel.
- ◇ Compatible with automatic placement equipment.
- ◇ Compatible with infrared and vapor phase reflow solder process.
- ◇ Mono-color type.
- ◇ Pb-Free.
- ◇ The product itself will remain within RoHS compliant Version.

## Descriptions

- ◇ The S190 SMD LED is much smaller than lead frame type Components,thus enable smaller board size,higher packing Density,reduced storage space and finally smaller equipment to be obtained.
- ◇ Besides, lightweight makes them ideal for miniature applications.etc.

## Applications

- ◇ Automotive:backlighting in dashboard and switch.
- ◇ Telecommunication:indicator and backlighting in Telephone and fax.
- ◇ Flat backlight for LCD, switch and symbol.
- ◇ General use.

### Package Dimension:

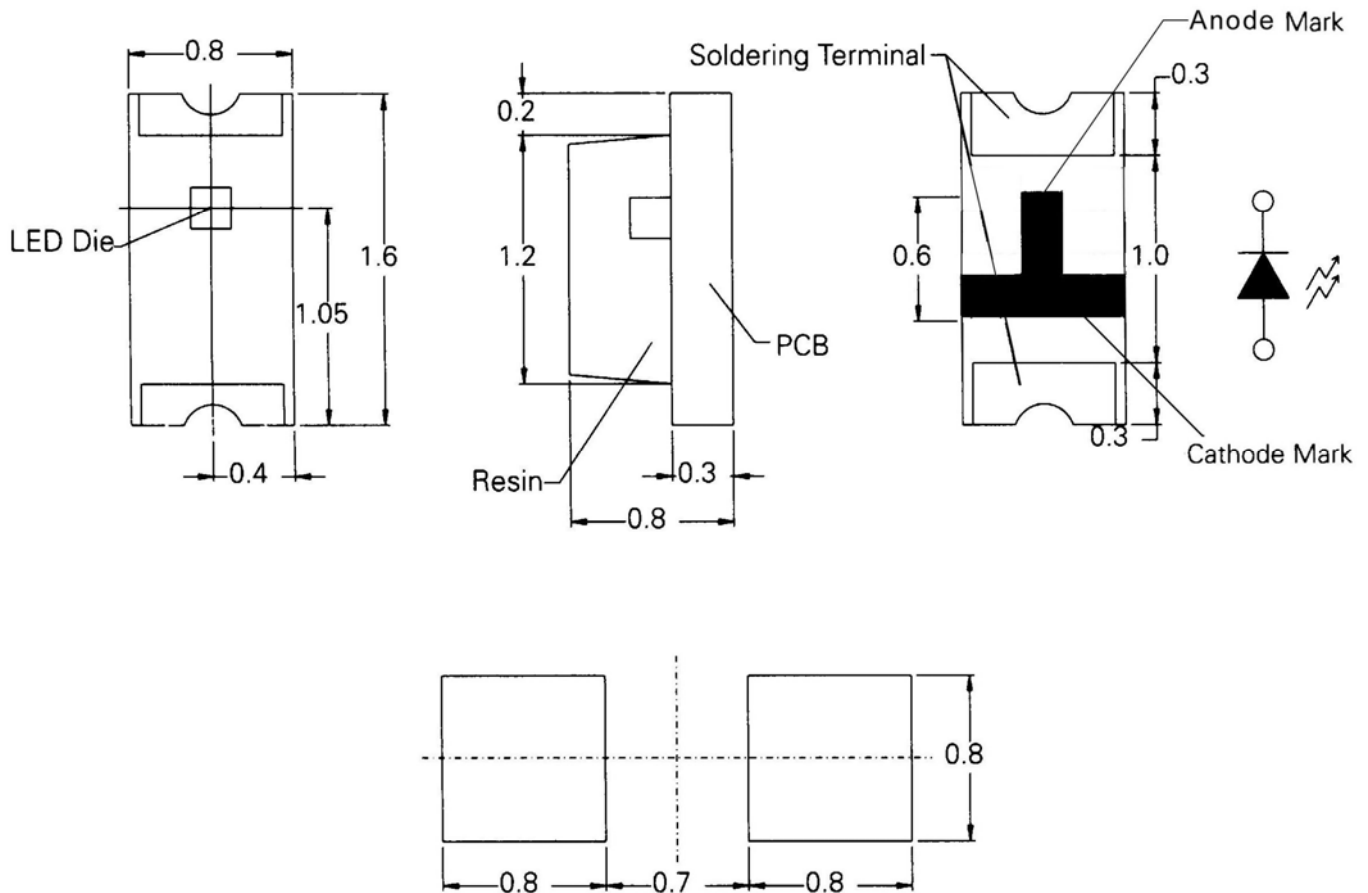

Part NO.	Material	Lens Color	Source Color
LL-S190SC-2S	GaAlAs	Water Clear	Super Bright Red

### Notes:

1. All dimensions are in millimeters (inches).
2. Tolerance is  $\pm 0.10$  (.004") unless otherwise specified.
3. Specifications are subject to change without notice

**Absolute Maximum Ratings at Ta=25°C**

Parameter	Symbol	MAX	Unit
Power Dissipation	PD	65	mW
Peak Forward Current (1/10 Duty Cycle, 0.1ms Pulse Width)	IFP	60	mA
Continuous Forward Current	IF	25	mA
Reverse Voltage	VR	5	V
Operating Temperature Range	Topr	-40°C to +85°C	
Storage Temperature Range	Tstg	-40°C to +100°C	
Soldering Temperature	Tsld	260°C for 5 Seconds	

**Electrical Optical Characteristics at Ta=25°C**

Parameter	Symbol	Min.	Typ.	Max.	Unit	Test Condition
Viewing Angle*	$2\theta_{1/2}$	---	140	---	Deg	(Note 2)
Forward Voltage	VF	---	1.8	2.5	V	IF =20mA
Reverse Current	IR	---	---	10	μA	VR=5V
Peak Emission Wavelength	$\lambda_p$	635	660	---	nm	IF=20mA
Dominant Wavelength	$\lambda_d$	633	640	---	nm	IF=20mA (Note 3)
Spectral Line Half-Width	$\Delta\lambda$	35	40	45	nm	IF=20mA
Luminous Intensity (Note 1)*	Iv	7	14	---	mcd	IF =20mA

- Luminous Intensity Measurement allowance is  $\pm 10\%$
- $\theta_{1/2}$  is the off-axis angle at which the luminous intensity is half the axial luminous intensity

## Reliability Test Items And Conditions

The reliability of products shall be satisfied with items listed below.

Confidence level:90%

LTPD:10%

### 1)Test Items and Results

No.	Test Item	Test Hours/Cycles	Test Conditions	Sample Size	Ac/Re
1	Resistance to Soldering Heat	6 Min	Tsld=260±5°C, Min. 5sec	25pcs	0/1
2	Thermal Shock	300 Cycles	H:+100°C 5min ∫ 10 sec L:-10°C 5min	25pcs	0/1
3	Temperature Cycle	300 Cycles	H:+100°C 15min ∫ 5min L:-40°C 15min	25pcs	0/1
4	High Temperature Storage	1000Hrs.	Temp:100°C	25pcs	0/1
5	DC Operating Life	1000Hrs.	If=20mA	25pcs	0/1
6	Low Temperature Storage	1000Hrs.	Temp:-40°C	25pcs	0/1
7	High Temperature/High Humidity	1000Hrs.	85°C/85%RH	25pcs	0/1

### 2)Criteria For Judging The Damage

Item	Symbl	Test Conditions	Criteria for Judgement	
			Min	Max
Forward Voltage	VF	If=20mA	—	F.V.*)×1.1
Reverse Current	IR	VR=5V	—	F.V.*)×2.0
Luminous Intensity	IV	If=20mA	F.V.*)×0.7	—

\*)F.V.:First Value

## Typical Electrical / Optical Characteristics Curves

(25°C Ambient Temperature Unless Otherwise Noted)

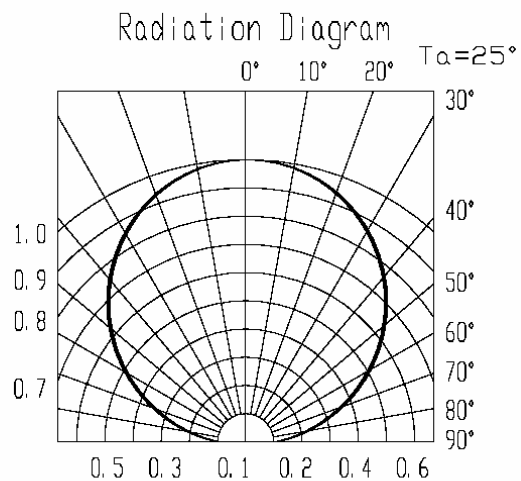
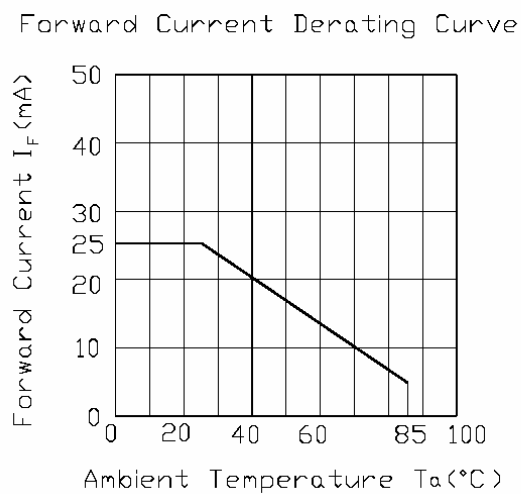
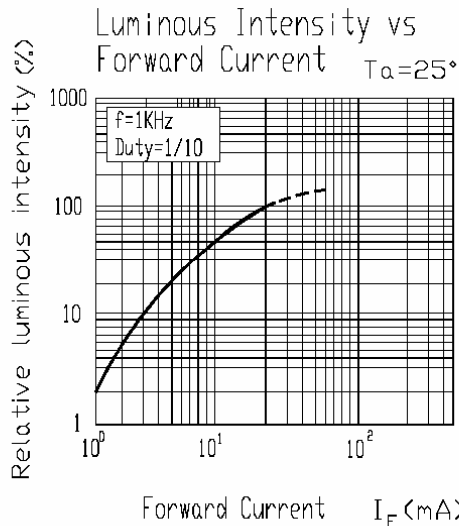
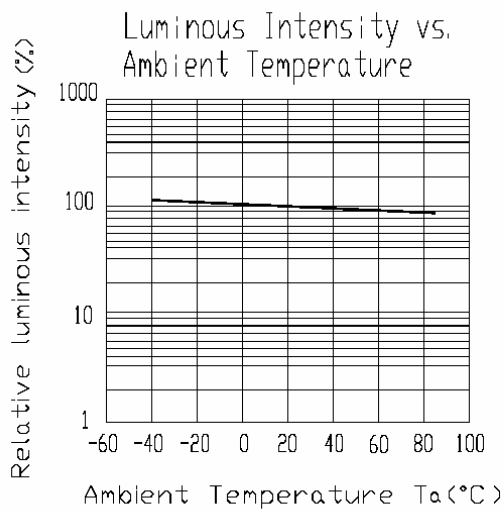
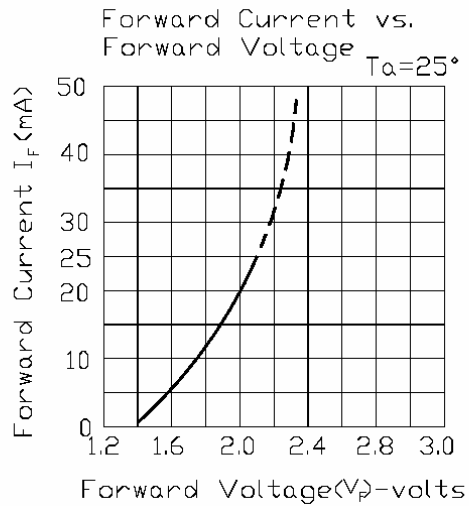
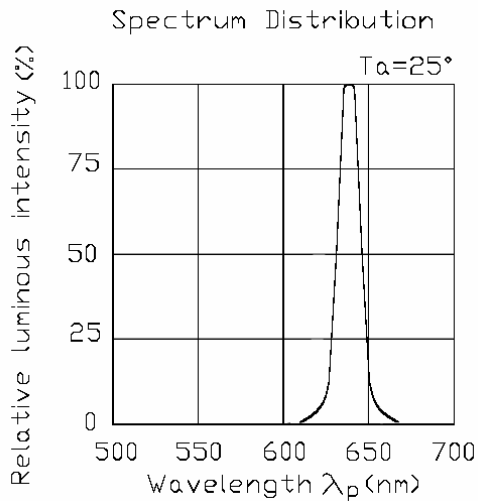



## Please read the following notes before using the datasheets

### 1. Over-current-proof

Customer must apply resistors for protection , otherwise slight voltage shift will cause big current change ( Burn out will happen ).

### 2. Storage

2.1 Do not open moisture proof bag before the products are ready to use.

2.2 Before opening the package, the LEDs should be kept at 30°C or less and 90%RH or less.

2.3 The LEDs should be used within a year.

2.4 After opening the package, the LEDs should be kept at 30°C or less and 70%RH or less.

2.5 The LEDs should be used within 168 hours (7 days) after opening the package.

2.6 If the moisture adsorbent material (silica gel) has faded away or the LEDs have exceeded the storage time, baking treatment should be performed using the following conditions.

Baking treatment:  $60 \pm 5^\circ\text{C}$  for 24 hours.

### 3. Soldering Condition

#### 3.1 Pb-free solder temperature profile

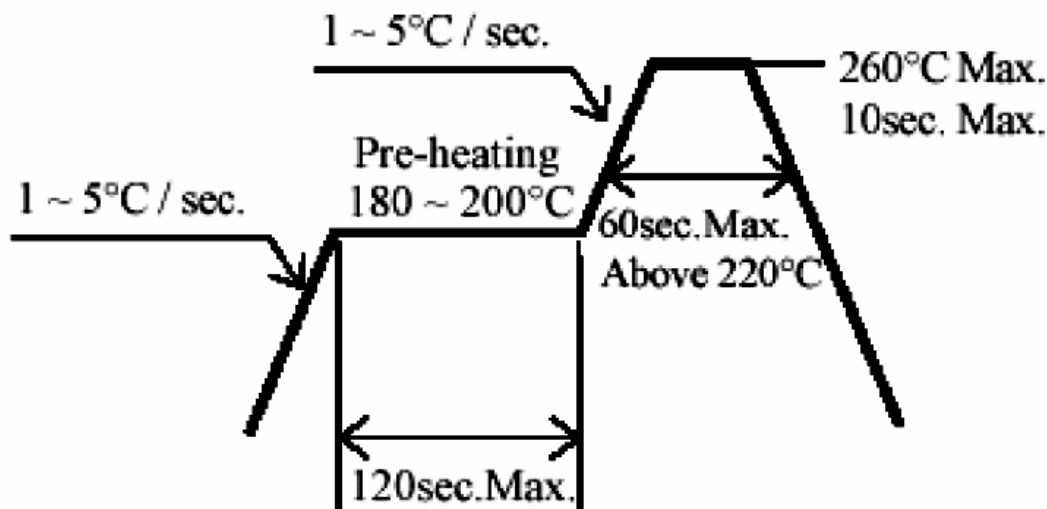

3.2 Reflow soldering should not be done more than two times.

3.3 When soldering, do not put stress on the LEDs during heating.

3.4 After soldering, do not warp the circuit board.

### 4. Soldering Iron

Each terminal is to go to the tip of soldering iron temperature less than  $260^\circ\text{C}$  for 5 seconds within once in less than the soldering iron capacity 25W. Leave two seconds and more intervals, and do soldering

of each terminal. Be careful because the damage of the product is often started at the time of the hand solder.



## 5.Repairing

Repair should not be done after the LEDs have been soldered. When repairing is unavoidable, a double-head soldering iron should be used (as below figure). It should be confirmed beforehand

whether the characteristics of the LEDs will or will not be damaged by repairing.

