

Referenc

1. Scope of Application

These specifications apply to chip type LED lamp, CITED, model CL-670S-HBE-SD-T

2. Part code

CL-670S-HBE-SD-T

①

②

③

④

①Series

670S: Multi-color
Ultra small,thin type
High brightness performing package

②Lighting color

HBE: High brightness blue

③Diffusion

SD : Diffused

④Shipping mode

T : Taping (standard)

Change history				Approved	Checked	Drawn	Symbol	CITED
							Name	CL-670S-HBE-SD
							Drawing No	
Mark	Date	The date	Description	Appro.	Drawn	CITIZEN ELECTRONICS CO.,LTD.		

Referenc

3. Outline drawing

Unit: mm
Tolerance: ±0.1

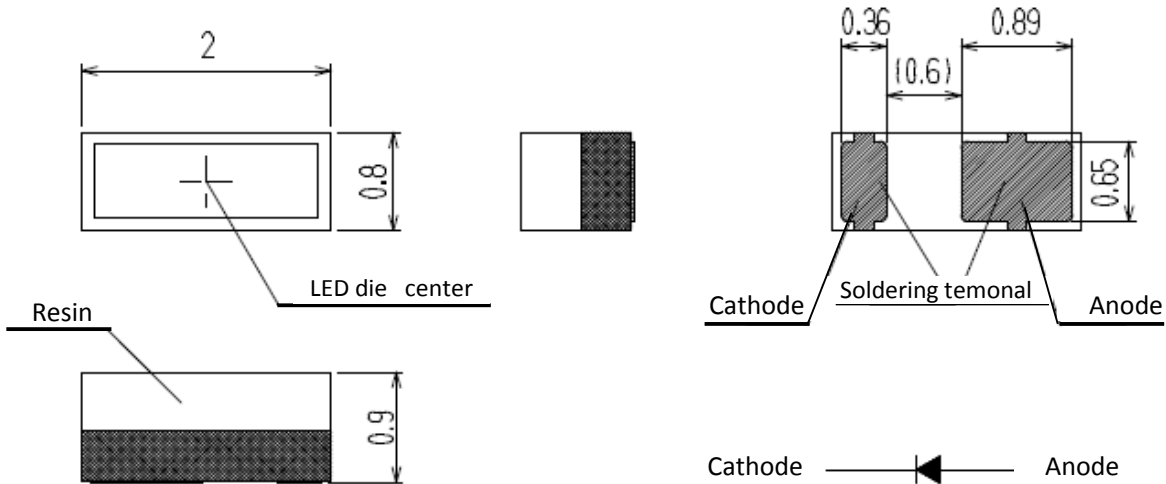

4. Performance

(1) Absolute Maximum Rating

Parameter	Symbol	Rating Value	Unit
Power Dissipation	P_d	-	mW
Forward Current	I_F	30	mA
Forward Pulse Current *	I_{FP}	100	mA
Reverse Voltage	V_R	4	V
Operating Temperature	T_{OP}	-25 ~ +80	°C
Storage Temperature	T_{ST}	-30 ~ +85	°C

* Forward Pulse Current : Duty ≤ Duty 1/10, Pulse width 0.1 msec

Change history					Approved	Checked	Drawn	Symbol	CITELED
								Name	CL-670S-HBE-SD
								Drawing No	
Mark	Date	The date	Description	Appr.	Drawn	CITIZEN ELECTRONICS CO.,LTD.			

SPECIFICATIONS OF CITILED

3/9

Referenc

(2) Electro-optical Characteristic

Ts=25°C

Parameter	Symbol	Condition	MIN	TYP	MAX	Unit
Forward Voltage	V _F	IF=20mA	2.8	3.20	3.6	V
Reverse Current	I _R	VR=4V	-	-	10	μA
Luminous Intensity *	I _v	IF=20mA	260	-	630	mcd
Dominant Wave length	λ _d	IF=20mA	461	470	477	nm

* In accordance with NIST standard

Note 1) The tolerance of Forward Voltage measurement is 3% at our tester.

Note 2) The tolerance of Luminous Intensity measurement is 10% at our tester

Note 3) The tolerance of Dominant Wave length measurement is 2nm at our tester

Note 4) Please be aware that the above electro-optical characteristics are guaranteed when applying the current values shown in the table.

Please consult us when this product is used under any other conditions.

Change history					Approved	Checked	Drawn	Symbol	CITILED		
								Name	CL-670S-HBE-SD		
										Drawing No	
Mark	Date	The date	Description	Appro.				Drawn	CITIZEN ELECTRONICS CO.,LTD.		

Referenc

5. Characteristic

◆ I_F - V_F Characteristics

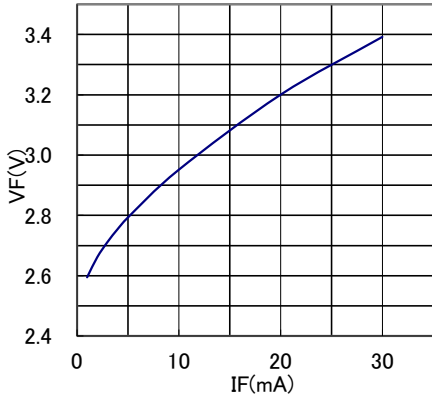

◆ I_V - V_F Characteristics

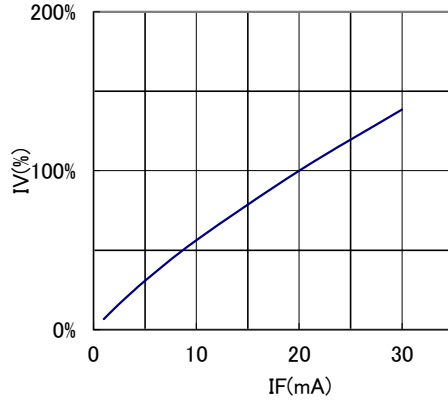

◆ I_{FMax} - T_a Characteristics

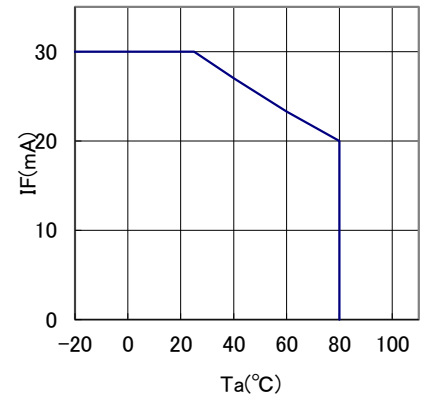

◆ I_V - T_a Characteristics

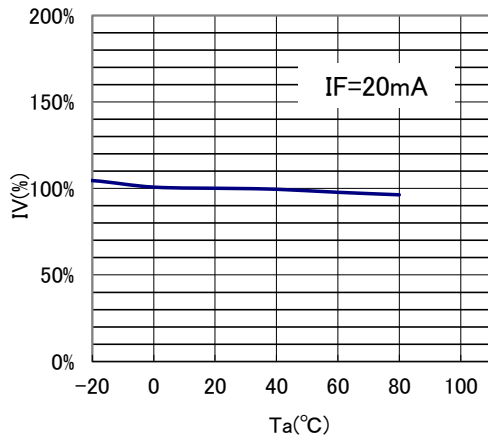

◆ V_F - T_a Characteristics

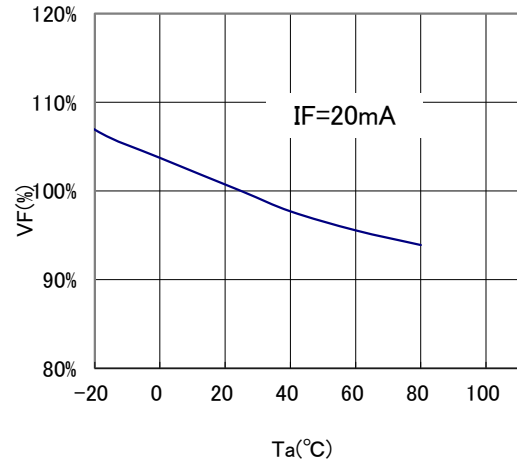

◆ Directive Characteristics

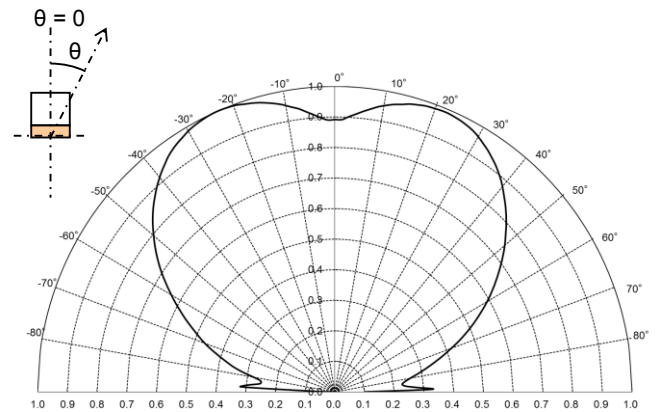
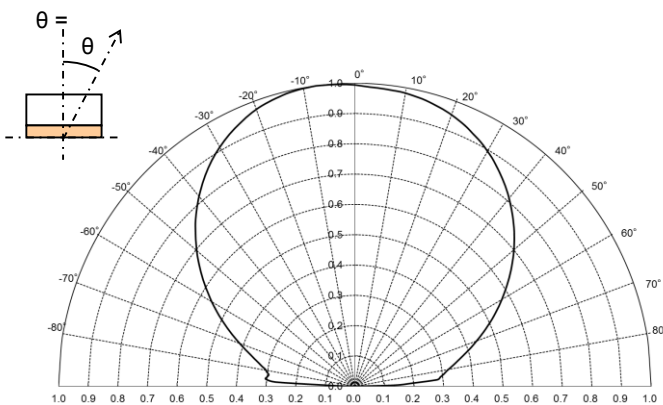

Change history				Approved	Checked	Drawn	Symbol	CITELED
							Name	CL-670S-HBE-SD
							Drawing No	
Mark	Date	The date	Description	Appro.	Drawn	CITIZEN ELECTRONICS CO.,LTD.		

Referenc

6. Reliability

(1) Details of the tests(With one of the three die emitting)

Test Item	Test Condition
Life Test in Continuous Operation	25±3°C, IF=20 mA ₋₁₂ ⁺²⁴ 500 hours
Low Temperature Storage Test	-30 ⁺³ ₋₅ °C × 500 ⁺²⁴ ₋₁₂ hours
High Temperature Storage Test	85 ⁺⁵ ₋₃ °C × 500 ⁺²⁴ ₋₁₂ hours
Moisture-proof Test	60 ±2° C, 90±5%RH for 500 ⁺²⁴ ₋₁₂ hours
Thermal Shock Test	-30°C × 30 minutes - 85°C × 30 minutes, 5-cycle
Solder Heat Resistance Test	Recommended temperature profile (reflow soldering) × 2, (2nd test must be started after the samples are stabilized thermally.)

(2)Judgment Criteria of Failure for Reliability Test

Ta=25°C

Measuring Item	Symbol	Measuring Condition	Judgement Criteria for Failure
Forward Voltage	V _F	I _F =20mA	> U×1.2
Reverse Current	I _R	V _R =4V	> U×2
Luminous Intensity	I _V	I _F =20mA	< S×0.5

U means the upper limit of the specified characteristics. S means the initial value.

Note: Measurement shall be taken between 2 hours and 24 hours, having returned the test each test pieces to the normal ambient conditions after the completion of each test.

Change history					Approved	Checked	Drawn	Symbol	CITELED
								Name	CL-670S-HBE-SD
								Drawing No	
Mark	Date	The date	Description	Appro.	Drawn	CITIZEN ELECTRONICS CO.,LTD.			

7. Taping Specifications (in accordance with JIS standard)

Referenc

(1) Shape and Dimensions of Reel

(Unit: mm)

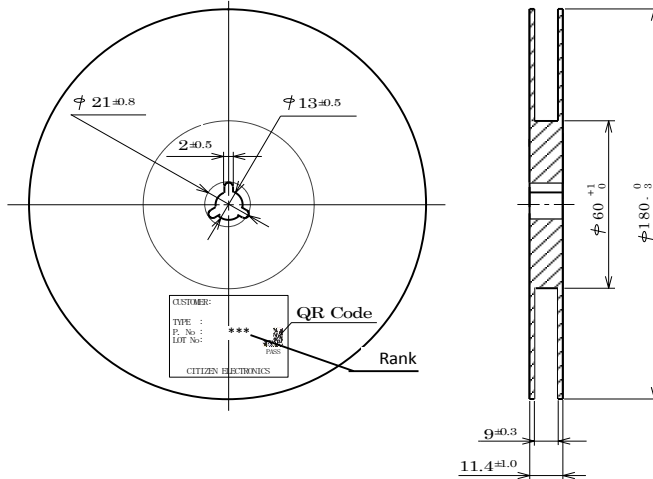

(2) Dimensions of Tape

(Unit: mm)

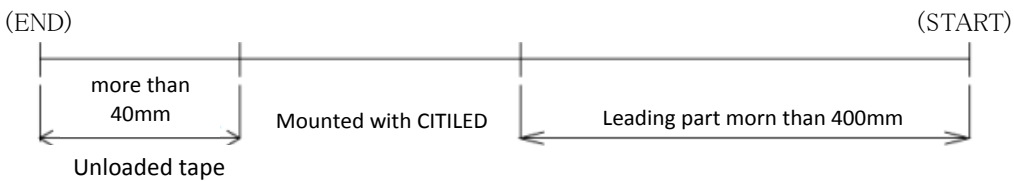
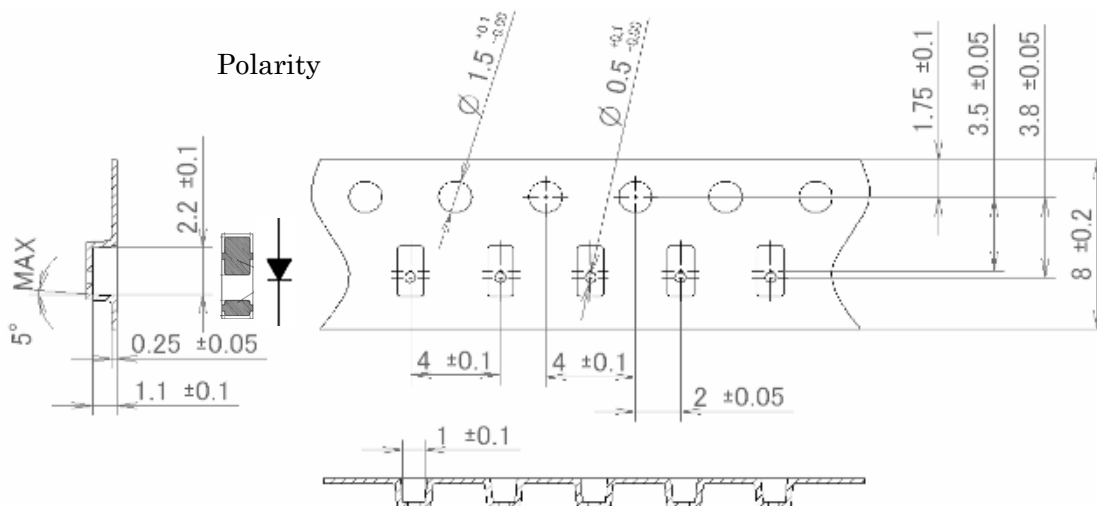

(4) Quantity : 2500 pcs/reel

(Please note that the shipping quantity of this product may be less than 2500 pieces per reel (minimum quantity:500 pieces) depending on the shipping quantity, shipping delivery date and other conditions. However, in this case, we will announce to you in advance.)

Change history						Approved	Checked	Drawn	Symbol	CITELED
									Name	CL-670S-HBE-SD
									Drawing No	
Mark	Date	The date	Description	Appro.	Drawn	CITIZEN ELECTRONICS CO.,LTD.				

Referenc

8. Packing Specifications

8-1. Moisture-proof Packing

To prevent moisture absorption during transportation and storage, reels are packed in aluminum envelopes which contain a desiccant with a humidity indicator.

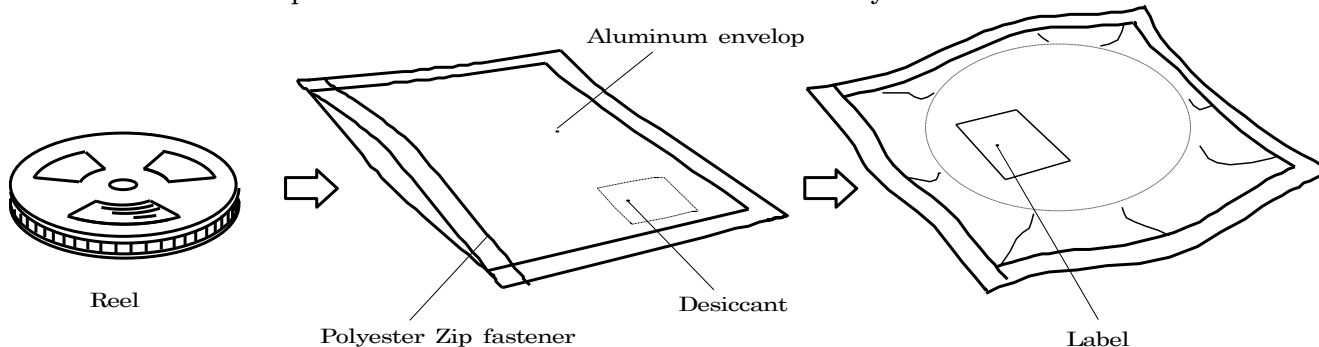

8-2. Storage

To prevent moisture absorption, it is strongly recommended that reels (in bulk or taped) should be stored in the dry box (or the desiccator) with a desiccant as the appropriate storage place. If not, the following is recommended.

Temperature: 5~ 30°C
Humidity: 60%RH max.

The devices should be mounted as soon as possible after unpacking. If you store the unpacked reels, please store them in the dry box or seal them into the envelop again.

8-3. Baking

If the devices have been stored over 6 months or unpacked over 7 days, it should be baked under the following conditions.

Baking conditions: 60°C×12 hours or more (reeled one)
 100°C×45 minutes or more (loose one)

Change history				Approved	Checked	Drawn	Symbol	CITELED
							Name	CL-670S-HBE-SD
							Drawing No	
Mark	Date	The date	Description				Appro.	Drawn

Referenc

9. Precautions

9-1. Soldering

(1) Lead free soldering

1) Following soldering paste is recommended

Melting temperature: 216 ~ 220°C.

Composition: 96.5Sn 3Ag 0.5Cu

2) The temperature profile at the top surface of the parts is recommended as shown below.

3) It is requested that products should be handled after their temperature has dropped down to the normal room temperature.

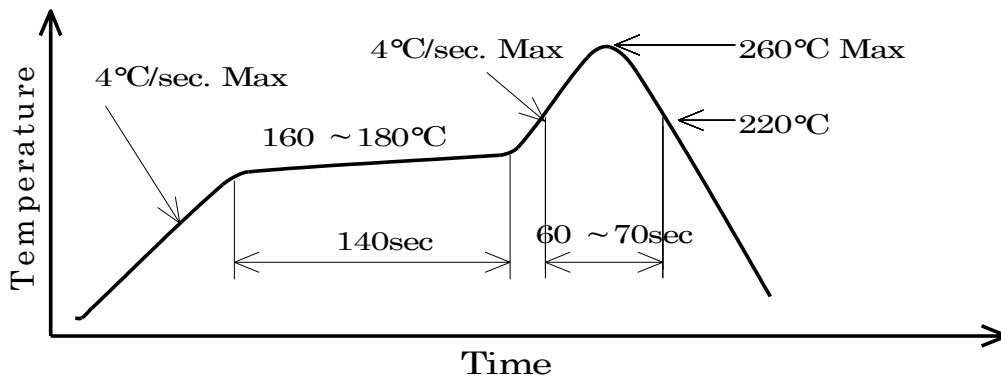

9-2. Washing

(1) When washing after soldering is needed, following conditions are requested.

a) Washing solvent: Pure Water

b) Temperature, time: 50°C or less × 30 seconds max.
or 30°C or less × 3 minutes max.

9-3. Other directions

(1) It is requested to avoid any stress added to the resin portion while it is heated.

(2) It is requested to avoid any friction by sharp metal nail etc. to the resin portion.

Change history					Approved	Checked	Drawn	Symbol	CITIED
								Name	CL-670S-HBE-SD
								Drawing No	
Mark	Date	The date	Description	Appro.	Drawn	CITIZEN ELECTRONICS CO.,LTD.			

10. Designing precautions

Referenc

- (1) The current limiting resistor should be placed in the circuit so that is driven within its rating. Also avoid reverse voltage (over-current) applied instantaneously when ON or OFF.
- (2) When pulse driving current is applied, average current consumption should be within the rating. Also avoid reverse voltage applied when put off.
- (3) Recommended soldering pattern

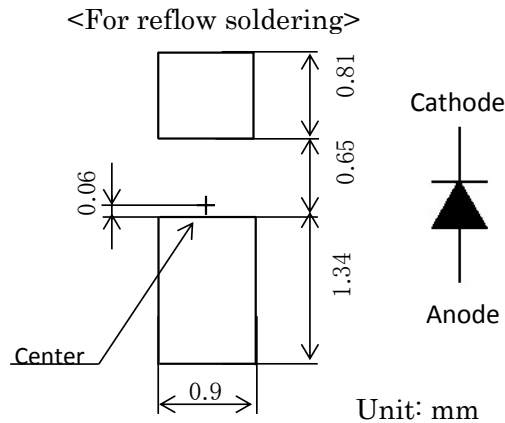

The above dimensions are not the one which guarantee the performance of mountability.

The use of the above pattern is recommended to use after deep study at your site.

- (4) When assembling the circuit board into the finished products, care must be taken to avoid the component parts from touching other parts.
- (5) When using multiple LEDs, it is required to connect a current limiting resistor on each path which the current flows to the LEDs.

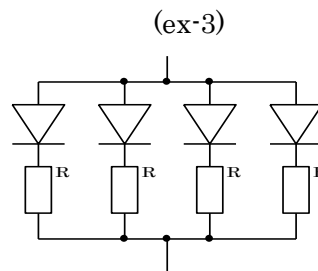
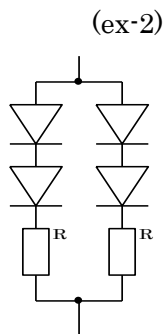
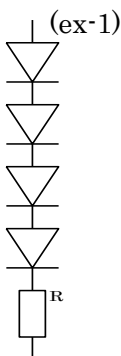

Change history					Approved	Checked	Drawn	Symbol	CITELED			
								Name	CL-670S-HBE-SD			
								Drawing No				
Mark	Date	The date	Description	Appr.				Drawn	CITIZEN ELECTRONICS CO.,LTD.			