



产品规格书 Specification

5050 三晶贴片
5050 Three Chip Top LED

产品型号/ Part No : WW-WXD50TC-Q1(M1)



批准	审核	制定
牛焕东	陶源	杨成琼

华宏光电子（深圳）有限公司	WAH WANG OPTOELECTRONIC (SHENZHEN) COMPANY LIMITED
地址:深圳市宝安区大浪街道华荣路 联建科技工业园第五栋	Address: Floor Block 5, Lianjian Science & Technology Industrial Park, Crossing of HuaRong Road, Dalang Sub-District, Bao'an, ShenZhen
电话: 0755-86019190	Tel: 0755-86019190
传真: 0755-86019197	Fax: 0755-86019197

S.D.N. / D.N. No. 送货单编号	
Customer Name 客户名称	
Sample Approval Signature 客户确认签署	
Date 日期	



■ 产品特性

■ Features:

PLCC封装的产品尺寸为: 5.0 (长) x 5.0 (宽) x 1.6 (高) mm

PLCC LED dimensions: 5.0(L) x 5.0(W) x 1.6(H) mm:

发散视角120°

Wide view angle 120°

环保防静电胶带包装

Available on tape and reel with Anti-electrostatic bag

产品性能稳定可靠

Compatible for all SMT Assembly and Lead-Free Soldering

RoHS Compliant

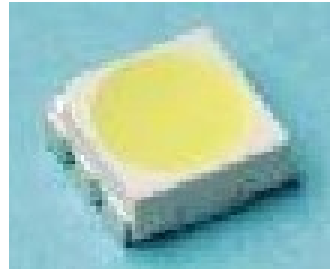

■ 应用

■ Applications:

背光液晶开关和显示

Backlight for LCD Switch and Display

装饰照明

Decorative Lighting

一般照明

General Lighting

汽车内部照明

Automotive Interior Lighting

常规使用

General Use

■ 产品尺寸图

■ Package Dimensions:

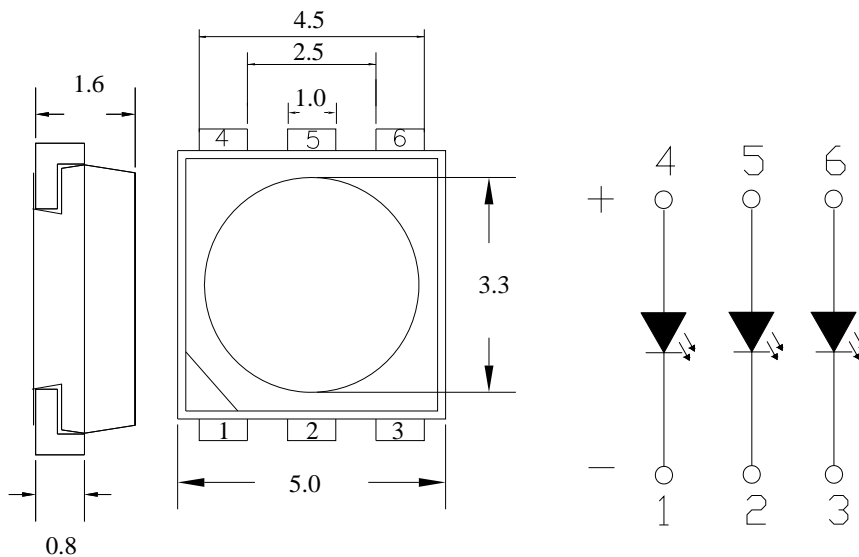

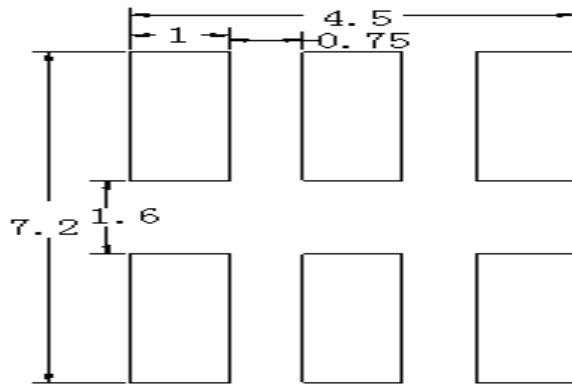

建议焊盘尺寸

Recommended Soldering Pads Dimensions

■ 注释

■ Recommended Soldering Pads Dimensions

1、上图所有尺寸的单位为毫米

All dimension units are in millimeters.

2、所有外形尺寸公差为 ± 0.25 毫米，除非另有说明

All dimension tolerances are ± 0.25mm unless otherwise noted.

■ 最大绝对额定值

■ Absolute Maximum Ratings:

参数 Parameter	符号 Symbol	数值 Value	单位 Unit
功耗 Power dissipation	P_d	200	mW
连续正向电流 Continuous Forward Current	I_F	60	mA
峰值正向电流 (1/10 Duty Cycle, 0.1ms Pulse Width) Peak Forward Current	I_{FP}	100	mA
反向电压 Reverse Voltage	V_R	5	V
静电放电(HBM) Electrostatic Discharge (HBM)	ESD	1000	V
工作温度范围 Operating Temperature Range	T_{opr}	-25 to +85	°C
存储温度范围 Storage Temperature Range	T_{stg}	-40 to +100	°C
无铅焊接温度 Lead Soldering Temperature	T_{sol}	260(for 5 sec)	°C



光电参数规格:

Electrical Optical Characteristics:

WW-WTD50TC-Q1(M1)

参数 Parameter	符号 Symbol	最小值 Min.	平均值 Typ.	最大值 Max.	单位 Unit	测试条件 Test Conditions
发光强度 Luminous Intensity	I_v	5800	---	8400	mcd	$I_F = 60\text{mA}$
参考光通量 Ref. Luminous Flux	Φ_v	23	25	---	lm	
颜色等级 Color Temperature & Binning	T_C	3700	---	4250	K	
	色区 Bin	NA4/5-NB4/5				
视角 Viewing Angle	$2\theta_{1/2}$	---	120	---	Deg	
正向电压 Forward Voltage	V_F	2.7	---	3.3	V	
显色指数 Color Rendering Index	R_a	80	---	---	---	
反向电流 Reverse Current	I_R	---	---	5	μA	$V_R = 5\text{V}$

WW-WRD50TC-Q1 (M1)

参数 Parameter	符号 Symbol	最小值 Min.	平均值 Typ.	最大值 Max.	单位 Unit	测试条件 Test Conditions
发光强度 Luminous Intensity	I_v	5800	---	8400	mcd	$I_F = 60\text{mA}$
参考光通量 Ref. Luminous Flux	Φ_v	22	24	---	lm	
颜色等级 Color Temperature & Binning	T_C	2600	---	2900	K	
	色区 Bin	WE4/5-WF4/5				
视角 Viewing Angle	$2\theta_{1/2}$	---	120	---	Deg	
正向电压 Forward Voltage	V_F	2.7	---	3.3	V	
显色指数 Color Rendering Index	R_a	80	---	---	---	
反向电流 Reverse Current	I_R	---	---	5	μA	$V_R = 5\text{V}$



WW-WRD50TC-Q1 (M1)

参数 Parameter	符号 Symbol	最小值 Min.	平均值 Typ.	最大值 Max.	单位 Unit	测试条件 Test Conditions
发光强度 Luminous Intensity	I_v	5800	---	8400	mcd	$I_F = 60\text{mA}$
参考光通量 Ref. Luminous Flux	Φ_v	22	24	---	lm	
颜色等级 Color Temperature & Binning	T_C	2900	---	3200	K	
	色区 Bin	WG4/5-WH4/5				
视角 Viewing Angle	$2\theta_{1/2}$	---	120	---	Deg	
正向电压 Forward Voltage	V_F	2.7	---	3.3	V	
显色指数 Color Rendering Index	R_a	80	---	---	---	
反向电流 Reverse Current	I_R	---	---	5	μA	$V_R = 5\text{V}$

WW-WND50TC-Q1(M1)

参数 Parameter	符号 Symbol	最小值 Min.	平均值 Typ.	最大值 Max.	单位 Unit	测试条件 Test Conditions
发光强度 Luminous Intensity	I_v	5800	---	8400	mcd	$I_F = 60\text{mA}$
参考光通量 Ref. Luminous Flux	Φ_v	23	25	---	lm	
颜色等级 Color Temperature & Binning	T_C	5700	---	6500	K	
	色区 Bin	CD4/5-CE4/5				
视角 Viewing Angle	$2\theta_{1/2}$	---	120	---	Deg	
正向电压 Forward Voltage	V_F	2.7	---	3.3	V	
显色指数 Color Rendering Index	R_a	80	---	---	---	
反向电流 Reverse Current	I_R	---	---	5	μA	$V_R = 5\text{V}$

注释 Notes:

- 1、发光强度、功耗和光通量的误差为 $\pm 10\%$
WW maintains a tolerance of $\pm 10\%$ on flux and power measurements.
- 2、波长的误差为 $\pm 1\text{nm}$ ；电压的误差为 $\pm 0.1\text{V}$
 $\lambda_d \pm 1\text{nm}$ ； A tolerance of $\pm 0.1\text{V}$ on forward voltage measurements
- 3、显色指数测试误差为 ± 2
The above Color Rendering Index measurement allowance tolerance is ± 2
- 4、所有测试都是基于华宏现有的标准测试平台
All measurements were made under the standardized environment of wahwang



■ 光电特性

Typical Optical Characteristics Curves

Forward Current vs Forward Voltage
伏安特性曲线

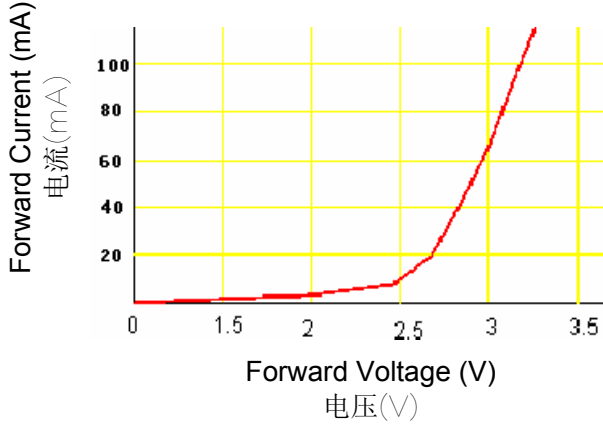

Forward Current vs Relative Luminous Intensity
电流和光通量的关系

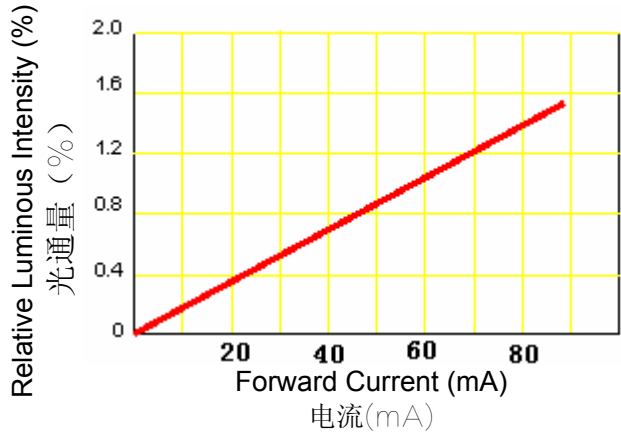

Spectral Distribution
波长曲线图

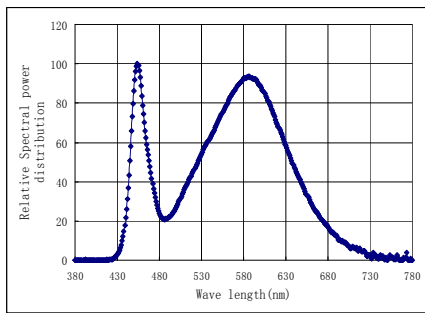

Luminous Intensity vs Ambient Temperature
发光强度与温度的关系曲线图

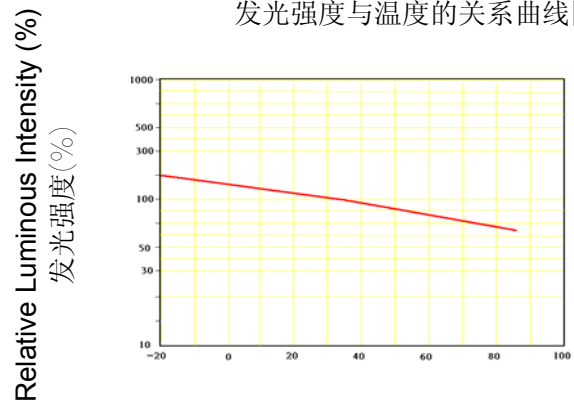

Ambient Temperature TA(°C)
环境温度(°C)

Forward Current Derating Curve
环境温度与电流的关系曲线图

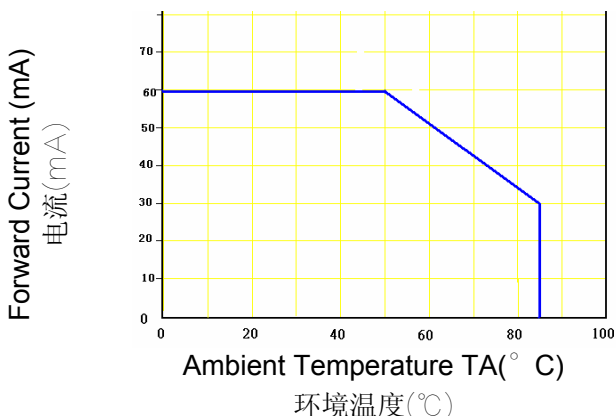

Radiation Diagram
发光角度图

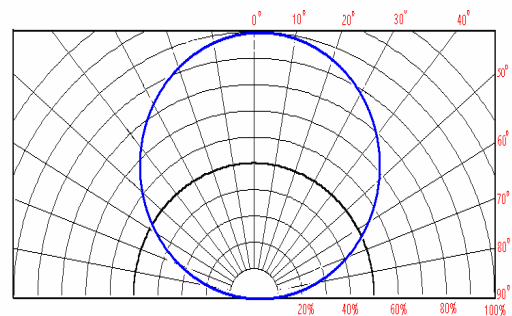



■ 色区坐标

■ Chromaticity Coordinate:

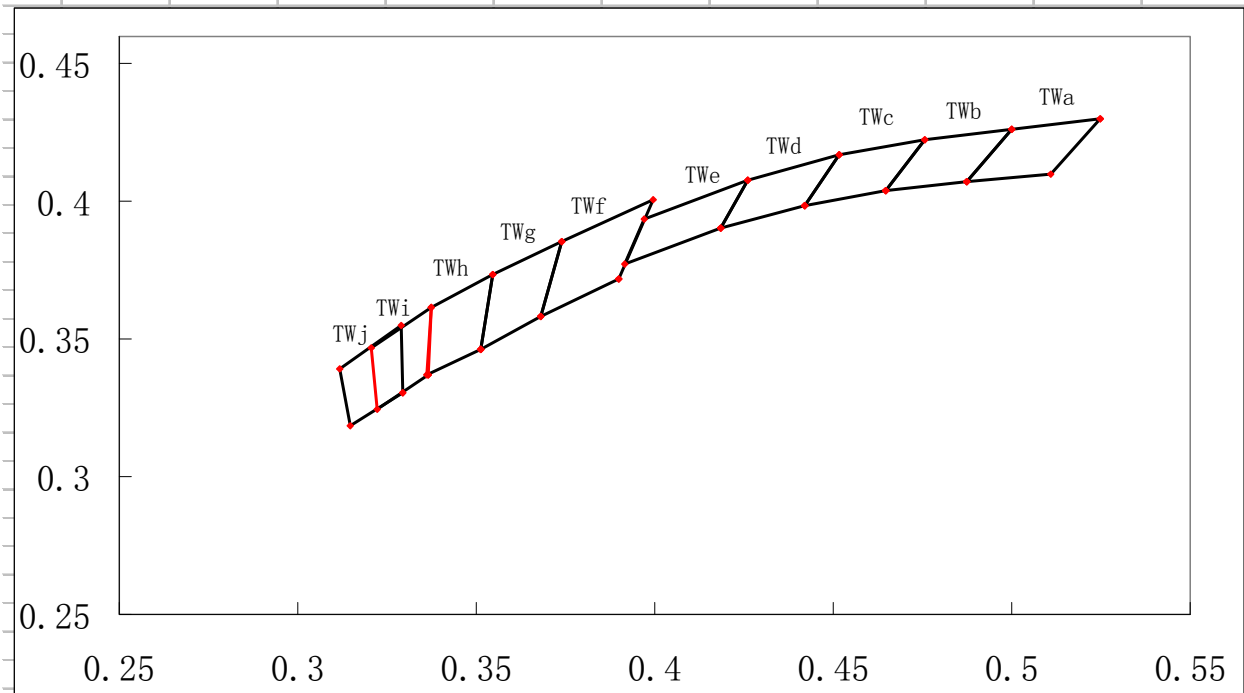

色区 Ranks		暖白 Warm White				白光 White					
TWa	X	0.5248	0.5108	0.4876	0.5002	TWf	X	0.3898	0.3680	0.3741	0.3997
	Y	0.4300	0.4102	0.4072	0.4265		Y	0.3716	0.3581	0.3856	0.4005
TWb	X	0.4876	0.4648	0.4758	0.5002	TWg	X	0.3680	0.3512	0.3548	0.3741
	Y	0.4072	0.4038	0.4225	0.4265		Y	0.3581	0.3465	0.3736	0.3856
TWc	X	0.4648	0.4420	0.4515	0.4758	TWh	X	0.3512	0.3360	0.3376	0.3548
	Y	0.4038	0.3985	0.4168	0.4225		Y	0.3465	0.3369	0.3616	0.3736
TWd	X	0.442	0.4185	0.4261	0.4515	TWi	X	0.3366	0.3222	0.3205	0.3376
	Y	0.3985	0.3902	0.4077	0.4168		Y	0.3369	0.3243	0.3470	0.3616
TWe	X	0.4185	0.3917	0.3970	0.4261	TWj	X	0.3294	0.3145	0.3117	0.3292
	Y	0.3902	0.3773	0.3936	0.4077		Y	0.3306	0.3187	0.3393	0.3548

颜色 Color	序号 Ref. No.	色区等级 Ranks	BIN 明细 Bins	相关色温(K) Correlated Color Temperature
暖白	1	TWa	Wa4/Wa5/Wb4/Wb5	2000-2300
	2	TWb	Wc4/Wc5/Wd4/Wd5	2300-2600
	3	TWc	We4/We5/Wf4/Wf5	2600-2900
	4	TWd	Wg4/Wg5/Wh4/Wh5	2900-3200
	5	TWe	Wi4/Wi5/Wj4/Wj5	3200-3700
自然白	6	TWf	Na4/Na5/Nb4/Nb5	3700-4250
	7	TWg	Nc4/Nc5/Nd4/Nd5	4250-4750
白光	8	TWh	Ca4/Ca5/Cb4/Cb5	4750-5300
	9	TWi	Cc4/Cc5/Cd4/Cd5	5300-6000
	10	TWj	Cd4/Cd5/Ce4/Ce5	5700-6500



备注:

Notes:

1. 客户可以选择以上任何一种颜色的色区

Customer can choose any group

2. X/Y 是参照 CIE1931, 色坐标 X/Y 的误差为 ± 0.01; 色温误差: 9000K-5000K ± 500K / 低于 5000K ± 50K

*X and Y are CIE1931; Color Coordinates Measurement allowance is ±0.01

Tolerance of Color Temperature: 9000K-5000K ± 500K / below 5000K ± 50K

■ 产品可靠性检测项目:

序号 No.	实验项目 Test Item	标准测试方法 Standard Test Method	测试条件 Test Conditions	检测时间和周期 Duration	不良数/测试数 Failure Rate
1	正常工作寿命 Steady State Operating Life	JEITA ED-4701 100 103	If=60mA Ta=25°C	1000hrs	0/22
2	低温贮藏 Low Temperature Storage	JEITA ED-4701 200 202	Ta=-40°C	1000hrs	0/22
3	高温贮存 High Temperature Storage	JEITA ED-4701 200 201	Ta=100°C	1000hrs	0/22
4	高温高湿贮藏 Temperature Humidity Storage	JEITA ED-4701 100 103	Ta=60°C RH=90%	1000hrs	0/22
5	冷热冲击 Thermal Shock	JEITA ED-4701 300 307	0°C ~ +100°C 5min~ 15sec ~ 5min	10 cycles	0/22
6	高低温循环 Temperature Cycle	JEITA ED-4701 100 105	H: +100°C 30min. ∫ : +25°C 5min. L: -40°C 30min	100 cycles	0/22
7	烫锡 Solder Heat	JEITA ED-4701 300 301	Tsld=260°C, 10sec (Max.)	2 times	0/22

■ 失效产品判定标准:

项目 Item	符号 Symbol	测试条件 Test Condition	最小值 Min.	最大值 Max.
正向电压 Forward Voltage	V _F	I _F = 60mA	--	*U.S.L×1.1
反向电流 Reverse Current	I _R	V _R = 5V	--	*U.S.L×2.0
发光强度 Luminous Intensity	I _v	I _F = 60mA	**L.S.L×0.7	--

*U.S.L.:超出标准最大值

*U.S.L.: Upper Standard Level

** L.S.L.:低于标准最低值

** L.S.L.: Lower Standard Level

■ 载带尺寸

■ Dimensions of the tape:

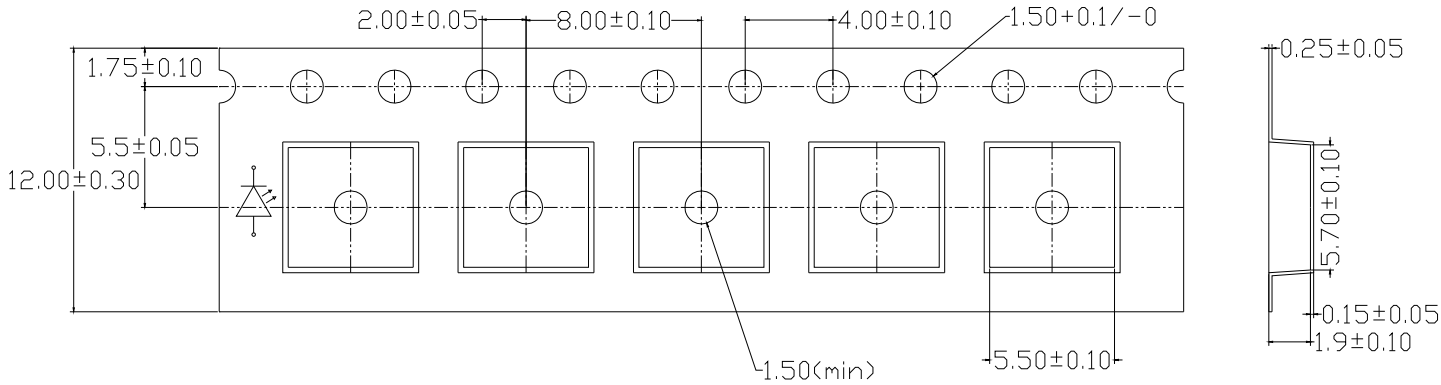

■ 包装盘的尺寸

■ Dimensions of the reel:

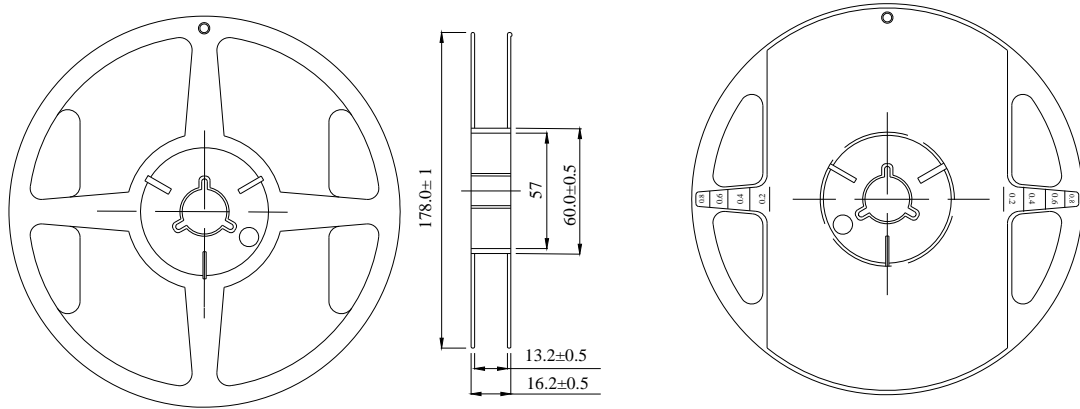

■ 包装

■ Packing:

防潮、防静电真空密封包装

■ Moisture, anti-static vacuum sealed packages

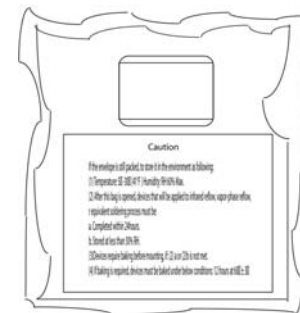
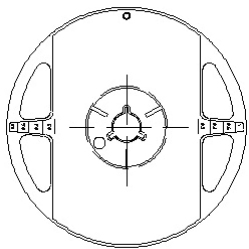

■ 注释

■ Note:

上图所有尺寸的单位为毫米，公差为 ± 2.0毫米，除非另有说明

All dimensions are in mm, tolerance is ± 2.0mm unless otherwise noted.



■注意事项:

PRECAUTION IN USE

1. 存储要求:

1.1 推荐储存环境

温度: 5°C ~ 30°C 的 (41°F ~ 86°F)

湿度: 相对湿度 60% 以下

1.2 防潮袋密封包装储存时间 3 个月, 起始时间以包装标签日期为准, 需在包装袋封口良好并无漏气现象, 且湿度卡未变为粉红色前提下使用, 如超过 3 个月的 LED 需按 2.2 要求除潮烘烤后才能正常使用。

1.3 表面贴装器件(SMDs)属于潮湿敏感性元件, 空气中的湿气通过扩散渗透到材料之中。当 SMD 元件焊接到电路板上的过程是将其通过温度为 150°C~260°C 的回流焊, 在高温状态下, 渗入其中的湿气快速膨胀产生足够的蒸汽压力损伤或毁坏 LED 元件, 从而出现材料内胶裂、分层或金线损失等可靠性失效问题;

2. 使用条件:

2.1. 打开产品包装, 首先查看静电袋内的湿度卡湿度圆的颜色显示 (如图所示), 10% 的湿度圆的颜色仍为蓝色时可正常使用 (图一); 若 10% 的湿度圆的颜色变为粉红色时, 其它档为蓝色 (图二), 请按照 75 ± 5°C 的烤箱烘烤 12H 后使用; 若 10%、20% 的湿度圆的颜色变为粉红色时, 其它档为蓝色 (图三), 此种情况需将材料寄回我司进行高温烘培除湿, 重新包装后方可使用。(若因条件限制无法退回请咨询公司提供除湿方案)

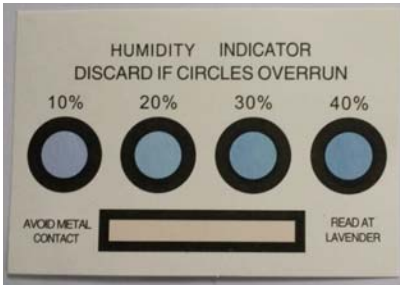

图一: 湿度卡完全未变色

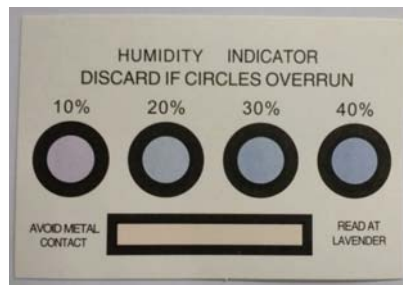

图二: 湿度卡 10% 处变为粉红色

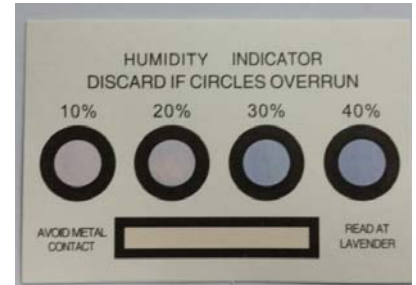

图三: 湿度卡 10、20% 处变为粉红色

2.2. 除潮烘烤条件: 打开静电袋, 将产品包转盘从静电袋中取出。放进 75 ± 5°C 的烤箱烘烤 12H, 避免高温烘烤。

2.3. 产品拆封后, LED 在 ≤30°C, ≤60%RH 相对湿度的条件下, 请在 12H 内使用完, 若没有使用完的产品需以 75 ± 5°C/12H 除潮后密封, 建议放入干燥柜中存放。

2.4. 焊接:

A-1. 回流焊接程序:

回流焊接		
条件	含铅焊接	无铅焊接
	温度	温度
预热	120~150°C	180~200°C
预热时间	120sec. Max.	120sec. Max.
峰值温度	240°C Max.	260°C Max.
焊接时间	10sec. Max.	10sec. Max.

注: 回流焊后应避免迅速冷却

A-2. 正常工作条件下的参数显示

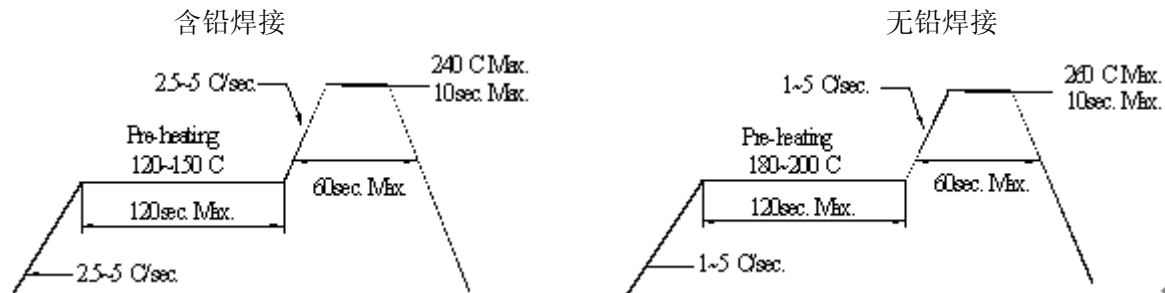



B-1. 手工焊接程序:

手工焊接	
溫度	350°C Max.
焊接時間	3秒. Max.
注: 单颗材料焊接时间	

B-2 手动焊接注意事项:

- (1).对于试样或者小批量作业的情况, 采用手动焊接为主.
- (2).使用锡膏、导电、导热胶时, 请严格按照相应的使用要求作业, LED发光二极管需与基材紧密连接, 焊接时, 可以轻轻按着产品, 防止产品和基材产生空隙, 如需要返修时, 请不要直接使用硬的工具撞击产品表面, 导致损伤产品, 可用镊子配合烙铁使用,如下示意图所示.
- (3).使用烙铁头的最佳温度为280°C, 烙铁的功率 ≤ 30 瓦. 每1PCS材料的焊接时间为 $\leq 3S$.
- (4).注意, 采用的焊接方式和条件不当极易对产品造成损坏.

2.5.清洗:

焊接后需做清洗

主要清洗剂:建议使用酒精

清洗条件:50°C* 30秒, 或30°C* 3分钟

超声波清洗:<15W/bath;容量: 最大1升

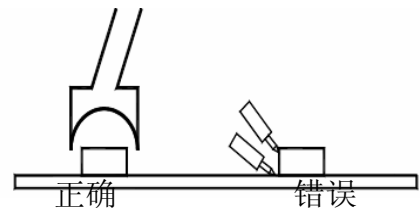

返修示意图

2.6.静电防护:

- (1).LED 是对静电很敏感的产品, 因此所有的机械设备、工作台、烙铁必须接上地线, 使用人员在接触产品时需佩戴防静电手环或防静电手套, 防止静电对产品造成损伤.
- (2).作业时避免一些易产生静电的物品摩擦产生静电对产品造成损伤, 所以作业场所尽量不使用易产生静电的物品, 建议使用离子风扇离子发生器.
- (3).使用的电流不要过载, 不可超过产品的额定电流和电压! 反向电压不可过大, 建议安装一个保护产品的驱动电路, 防止因电流或电压过大造成对产品造成损伤.
- (4).用户需要不定时地检查静电防护措施的效果和落实状况.

3.其他注意事项:

- 3.1.电路设计时, 建议使用定电流驱动设计, 如以定电压设计, 请考虑不同电压所造成的影响.
- 3.2.LED产品为单向导通性, 使用安装前请确认产品极性, 一般产品缺口边为产品负极, 若装反, 不能正常点亮, 且在施加电压时容易造成LED芯片损伤或失效.
- 3.3.注意正确的电路设计, 不当之设计与电流控制, 易造成LED失效, 如电流过大引起寿命问题甚至烧毁, 电流过小引起亮度不足等.
- 3.4.不同BIN号之LED建议分开使用, 若需安装在同一个组件时, 请先确认是否可满足相关电气及光学特性要求, 如电流是否均衡, 光色、亮度的一致性.

Recommended storage environment

Temperature: 5°C ~ 30°C (41°F ~ 86°F)

Humidity: 60% RH Max.

Moisture-proof bag sealed packaging can be stored up to 3 months, the starting date is according the date show on the label, this components should only be used when the bag is fully sealed and the humidity indicator haven't turned into pink color. After storage for 3 months, please according to section 2.2 for baking treatment before use.

Surface mount devices (SMDs) are moisture-sensitive components, moisture in the air penetrate into the material by diffusion. when SMD components are soldered onto the PCB board, the process is undergo a reflow with temperature 150 °C -260 °C. With this high temperature, if the component inside contains moisture, the moisture expansion produces vapor pressure, which is sufficient to damage or destroy the LED elements, this will appears crack in the plastic material, layered or gold wire losses and reliability failures of the component.;

Using condition:

Open the packing, First check the Humidity indicator (as show below), can be used if the 10%-circle is blue in color (Fig 1). If the 10%-circle is pink (others are all blue, Fig 2), please undergo the baking treatment with 75 ± 5°C for 12 hours before use. If both 10%- and 20%- circle is pink (others are all blue, Fig 3), please send back the component to us for baking and repacking. (for some limitations which cannot send the component back to us, please contact us for providing other dehumidification method)

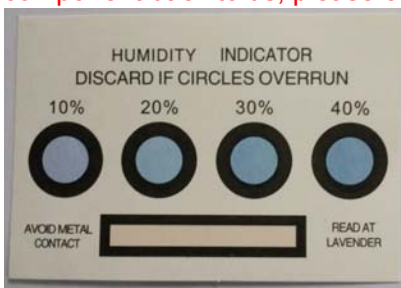

Fig 1: no color change

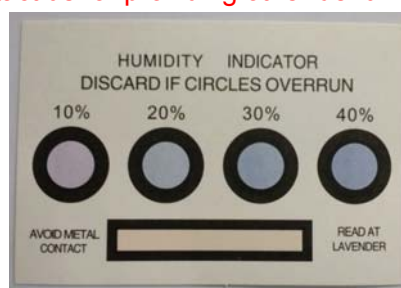

Fig 2: 10%-circle in pink color

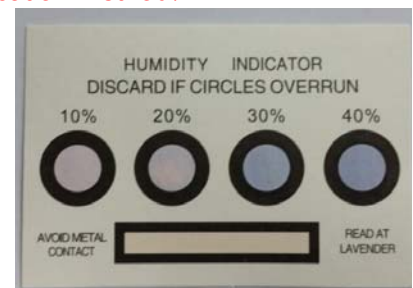

Fig 3: 10%/20%-circle in pink color

Baking treatment : Open-static bag, the product and reel dial out from the Static bag, and then 75±5°C for 12 hours baking treatment.

All un-sealed products are recommended to be used within 12 hours (under a condition of ≤30°C, ≤60%RH). Seal all remaining products in time, recommend storage in dry cabinet storage. It must be baking treatment when using the remaining product.

Soldering

A. Reflow Process

Reflow Soldering		
	Lead Solder	Lead – free Solder
Pre-heat	120~150°C	180~200°C
Pre-heat time	120sec. Max.	120sec. Max.
Peak temperature	240°C Max.	260°C Max.
Soldering time	10sec. Max.	10sec. Max.
Condition	refer to Temperature-profile 1	refer to Temperature-profile 2

After reflow soldering rapid cooling should be avoided.

[Temperature-profile (Surface of circuit board)] Use the conditions shown to the under figure.

< 1 : Lead Solder >

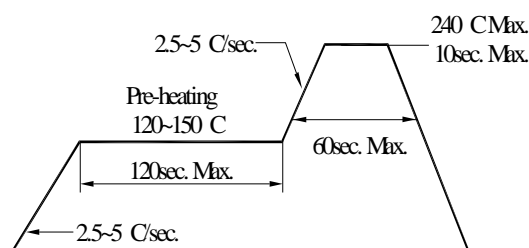

< 2 : Lead-free Solder >

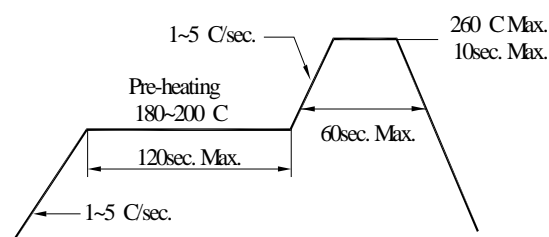

B. Manual Soldering Process



Hand Soldering	
Temperature	350°C Max.
Soldering time	3sec. Max. (one time only)

- For prototype builds or small series production runs it is possible to place and solder the LED by hand.
- Dispense thermal conductive glue or grease on the substrates and follow its curing specifications. Gently press LED housing to closely connect LED and substrate.
- It is recommended to hand solder the leads with a solder tip temperature of 280°C for less than 3 second, at a time with a soldering iron of less than 30W. Solder at intervals of two seconds or more.
- Take caution and be aware that damaged products are often a result of improper hand soldering technique.

Rework

- Customer must finish rework within 5 sec under 260°C
- The head of iron cannot touch the resin
- Twin-head type is preferred.

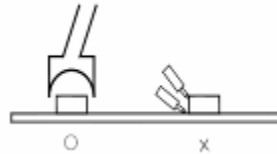

Cleaning :

The conditions of cleaning after soldering:

An alcohol-based solvent such as Isopropyl Alcohol(IPA) is recommended.

Temperature Time:<50°C*30sec,or <30°C*3min

Ultra sonic cleaning:<15W/bath; Bath volume:1liter max.

Curing:100 max,<3min

Cautions of Pick and Place:

It should be avoided to load stress on the resin during high temperature.

Avoid rubbing or scraping the resin by any object.

Electric-static may cause damage to the component. Please confirm that the equipment is grounding well. Using an ionizer fan is recommended.

Cautions of Design and Applications:

It should be done to connect with a current-limiting serial resistor. Avoid to drive reverse voltage over the specifications on LED when ON/OFF. Any application should refer to the specifications of absolute maximum ratings.

The dimensions of the recommended soldering pattern may not meet every users. Please confirm and study before designing the soldering pattern in order to obtain the best performance of soldering.

Do not contact with any component on the assembly board.

Static Electricity:

These products are so sensitive to static electricity charge so that all equipment and machinery must be properly grounded and it is recommended to use a wristband or anti-electrostatic glove when handling the SMD LED.

Particularly if any over-current and over-voltage which exceed the Absolute Maximum Ratings of LED applied, the more energy may cause damage or possibly result in electrical destruction of the Products.

A protection design should be installed in the LED driving circuit, which does not exceed the max. rating for surge current during on/off switching.

A tip if soldering iron is requested to be grounded .An ionizer should be installed when risk of static generation is high.

If the countermeasures mentioned above are implemented, LED can work well.

Users are required to check those countermeasures when problems occur by static electricity charge

Other:

Damaged SMD LED will show unusual characteristics such as leak current remarkably low current. Increase, turn-on voltage becomes lower and the SMD LED get unlighted at low current.

In automatic mounting of the SMD LEDs on printed circuit boards, any bending and pulling forces or shock against the SMD LEDs shall be kept min. to prevent them from expanding or electrical failures and mechanical damages of the devices.