



Specific Lighting Product Data Sheet LTW-5630AZLxx-EU

Spec No. :
Effective Date:
Revision:

Specific lighting LTW-5630AZLxx-EU

1. Description

The LiteON 5630 Product series is a wide beam angle standard-dimension package, combining the lifetime and reliability advantages of Light Emitting Diodes with the brightness of conventional lighting. It gives you total design freedom and unmatched brightness, creating a new opportunities for solid state lighting to displace conventional lighting technologies.

1.1 Features

- Package in 8mm tape on 7" diameter reels.
- Compatible with automatic placement equipment.
- Compatible with infrared and vapor phase reflow solder process.
- EIA STD package.
- I.C. compatible.
- Meet green product and Pb-free(According to RoHS)

1.2 Available Part Numbers

CCT	Part Number
6500K	LTW-5630AZL65-EU
5700K	LTW-5630AZL57-EU
5000K	LTW-5630AZL50-EU
4000K	LTW-5630AZL40-EU
3500K	LTW-5630AZL35-EU
3000K	LTW-5630AZL30-EU
2700K	LTW-5630AZL27-EU

**Specific lighting
LTW-5630AZLxx-EU**

2. Outline Dimensions

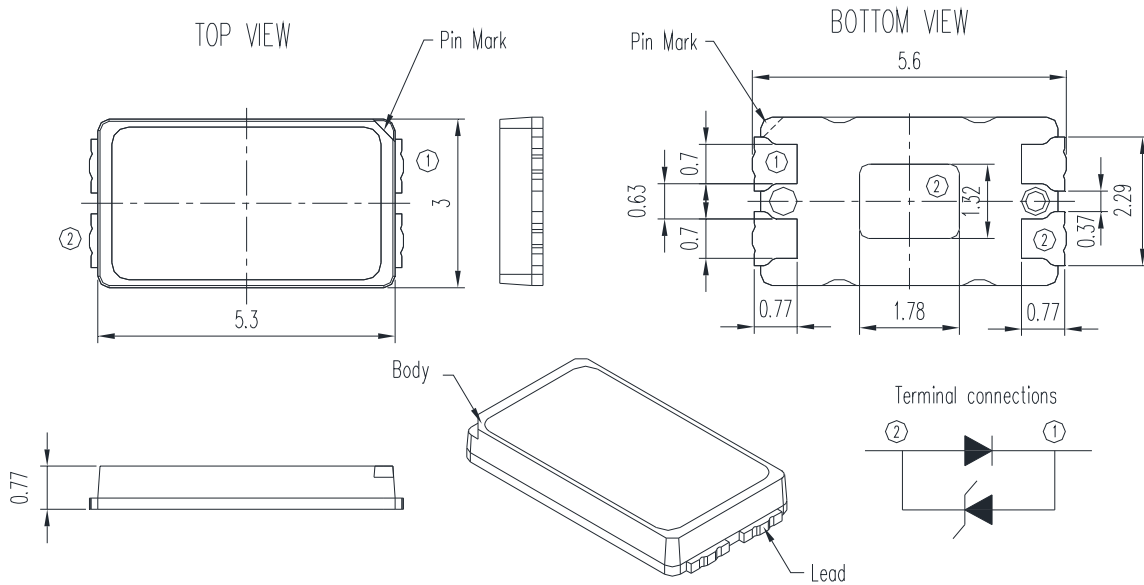

Part No.	Lens Color	Source Color
LTW-5630AZL65-EU	Orange	InGaN Blue
LTW-5630AZL57-EU		
LTW-5630AZL50-EU		
LTW-5630AZL40-EU		
LTW-5630AZL35-EU		
LTW-5630AZL30-EU		
LTW-5630AZL27-EU		

Notes:

1. All dimensions are in millimeters.
2. Tolerance is ± 0.2 mm (.008") unless otherwise noted.

**Specific lighting
LTW-5630AZLxx-EU**

3. Absolute Maximum Ratings at $T_a=25^{\circ}\text{C}$

Parameter	Symbol	Rating	Unit
Power Dissipation	P_o	650	mW
Continuous Forward Current	I_F	200	mA
Pulse Forward Current	I_{FP}	260	mA
Operating Temperature Range	T_{opr}	-40 ~ +85	$^{\circ}\text{C}$
Storage Temperature Range	T_{stg}	-40 ~ +100	$^{\circ}\text{C}$
Junction Temperature	T_j	≤ 120	$^{\circ}\text{C}$

Notes :

1. 1/10 duty cycle, Pulse width $\leq 100 \mu\text{s}$.
2. Forbid to operating at reverse voltage condition for long.
3. It is recommended to follow de-rating curve to use maximum rating to ensure LED can operated normally.

Specific lighting LTW-5630AZLxx-EU

4. Electro-Optical Characteristics

4.1 Typical Performance

Parameter	Symbol	Values								Unit	Test Condition
		Typ.	2700	3000	3500	4000	5000	5700	6500		
Correlated Color Temp.	CCT	Typ.	2700	3000	3500	4000	5000	5700	6500	'K	
Chromaticity	x	Typ.	0.458	0.434	0.408	0.382	0.345	0.329	0.312	-	$I_F = 120\text{mA}$
Coordinates	y	Typ.	0.410	0.403	0.392	0.380	0.355	0.342	0.328		
Luminous Flux ¹	Φ_v	Min	41.0	42.5	44.0	44.0	45.5	44.0	42.5	lm	
		Typ.	50.0	53.0	54.0	55.0	54.0	55.0	53.0		
		Max.	63.5	65.0	66.5	66.5	68.0	66.5	65.0		
Optical Efficiency	η_{opt}	Typ.	139	147	150	153	150	153	147	lm/W	
Color Rendering Index	CRI	Min.	80							-	
Viewing Angle	$2\theta_{1/2}$	Typ.	120							deg	
Forward Voltage	V_F	Min	2.8						V		
		Typ.	3.0								
		Max.	3.3								
Thermal Resistance	R_{jt}	Typ.	15							°C/W	
ESD-Withstand Voltage	ESD	Min	5K							HBM	V

Notes

- Luminous flux is the total luminous flux output as measured with an integrating sphere.
- I_v (flux Φ_v) classification code is marked on each packing bag.
- The chromaticity coordinates (x, y) is derived from the 1931 CIE chromaticity diagram.
- Caution in ESD:

Static Electricity and surge damages the LED. It is recommended using a wrist band or anti-electrostatic glove when handling the LED. All devices, equipment and machinery must be properly grounded.

- CAS140B is the test standard for the chromaticity coordinates (x, y) & Φ_v .
- The chromaticity coordinates (x, y) guarantee should be added +/- 0.01 tolerances
- CRI measurement allowance is ± 5
- The thermal resistance is defined

as the figure, R_{jt} is the R_{th} from T_j to thermal pad solder:

Reference for thermal resistance:

Using 2.5x 2.5x 0.17 cm aluminum MCPCB,

$R_{jt}=15^\circ\text{C/W}$, $R_{js}=19^\circ\text{C/W}$

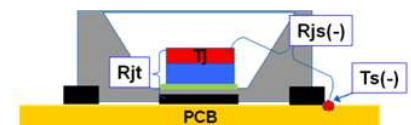

- ◆ $R_{js} = R_{th}$ of T_j to T_s
- ◆ $R_{jt} = R_{th}$ of T_j to Thermal pad solder
- ◆ R_{th} definition in Datasheet = R_{jt}
- ◆ $R_{jt} < R_{jc}$
- ◆ $T_j = R_{js} \cdot I^2 + T_s$

Specific lighting LTW-5630AZLxx-EU

4.2 Forward Current vs. Lumen and Voltage

Current (mA)	VF (V)	Lumen (lm)						
		2700K	3000K	3500K	4000K	5000K	5700K	6500K
20	2.72	9.2	9.8	10.0	10.2	10.0	10.1	9.9
40	2.80	18.1	19.3	19.7	20.0	19.7	20.0	19.3
60	2.86	26.6	28.3	28.8	29.3	28.8	29.2	28.2
80	2.92	34.5	36.9	37.5	38.1	37.4	38.1	36.9
100	2.98	42.4	45.1	45.9	46.7	45.9	46.7	45.0
120	3.03	50.0	53.0	54.0	55.0	54.0	55.0	53.0
140	3.08	57.0	60.5	61.6	62.9	61.7	62.8	60.6
160	3.14	64.0	68.0	69.2	70.4	69.3	70.4	68.0
180	3.18	70.4	74.9	76.2	77.7	76.3	77.6	74.9
200	3.23	76.3	81.2	82.7	84.2	82.7	84.0	81.2

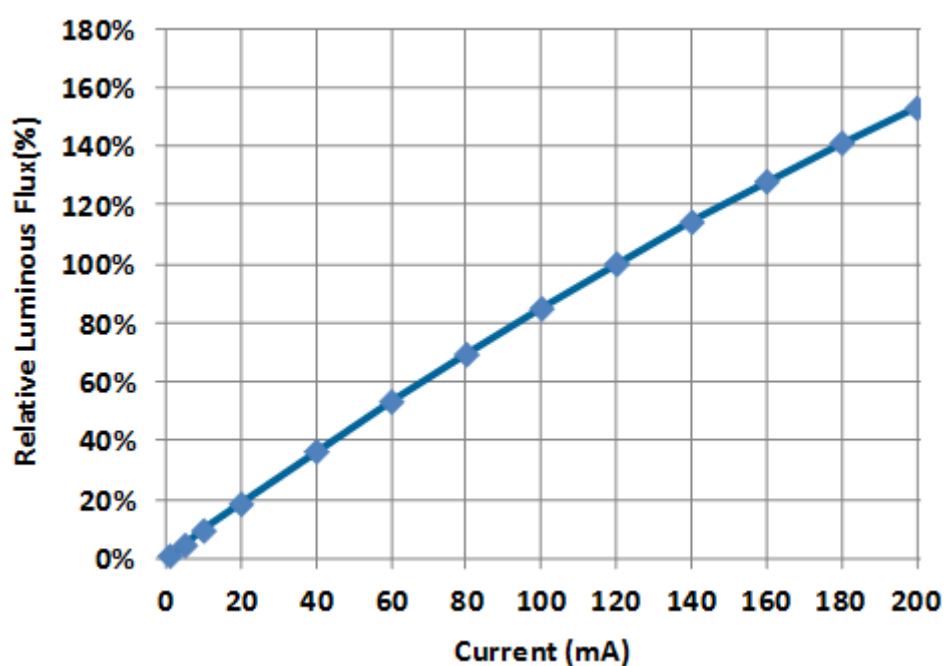

Specific lighting LTW-5630AZLxx-EU

4.3 Relative Spectral Power Distribution at Typical Current

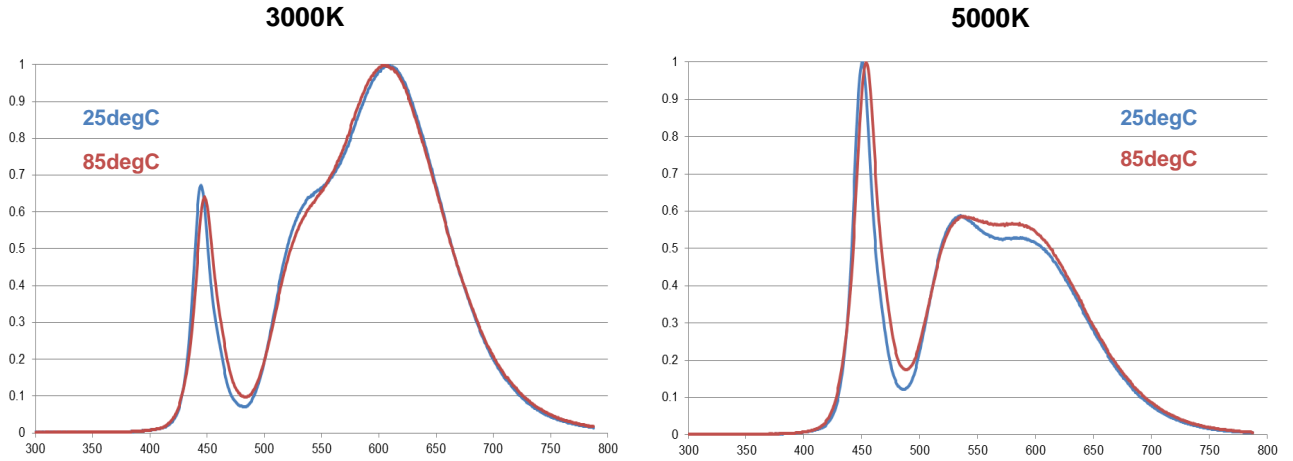

4.4 Radiation Characteristics

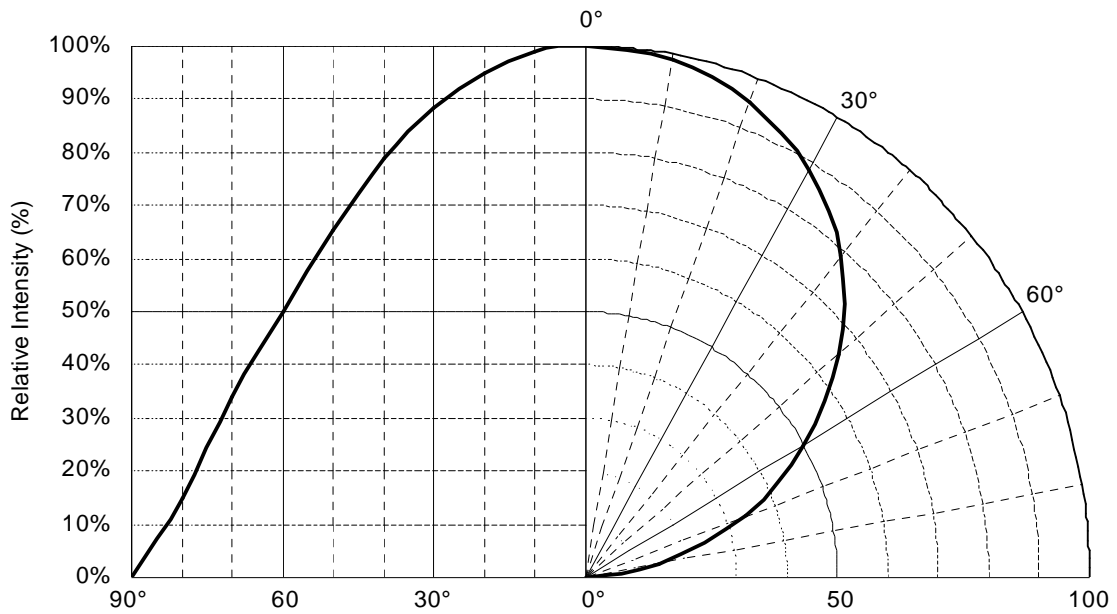

Specific lighting
LTW-5630AZLxx-EU

4.5 Forward Current vs. Forward Voltage

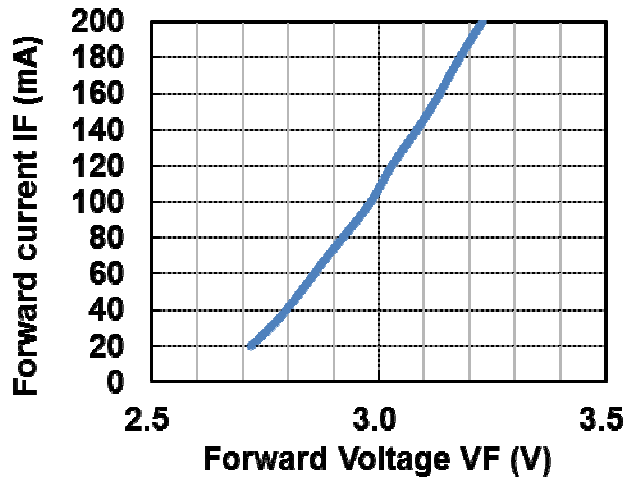

4.6 Forward Current Derating Curve vs. Ambient Temperature

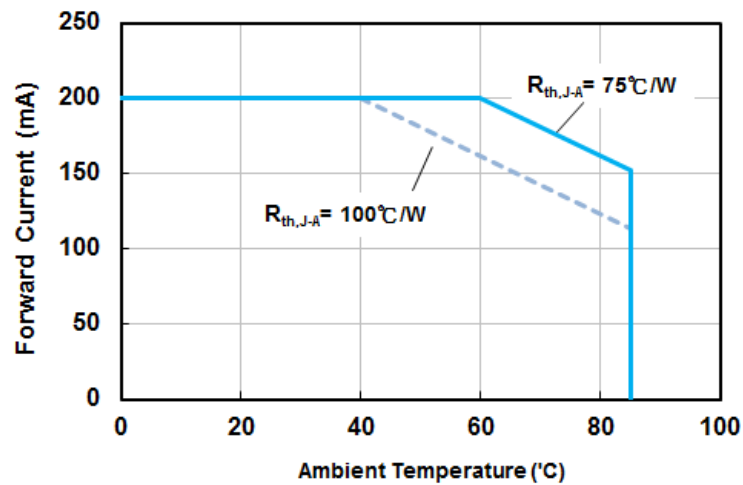

**Specific lighting
LTW-5630AZLxx-EU**

4.7 Relative Intensity vs. Junction Temperature

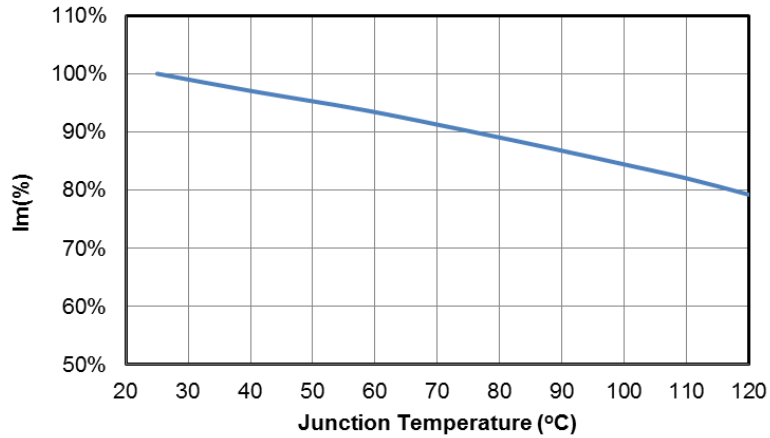

4.8 Forward V_F

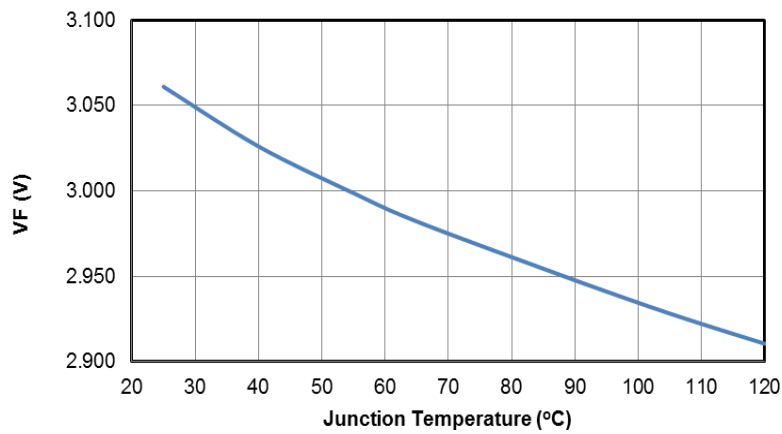

Specific lighting
LTW-5630AZLxx-EU

5. Binning Definition

5.1 Color Bin

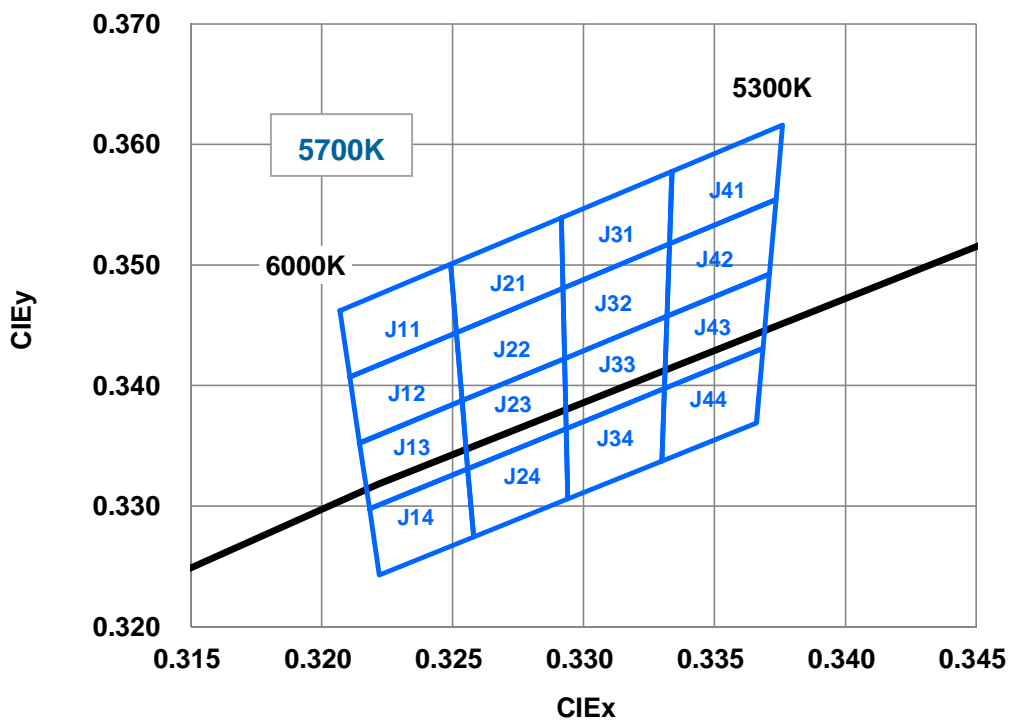
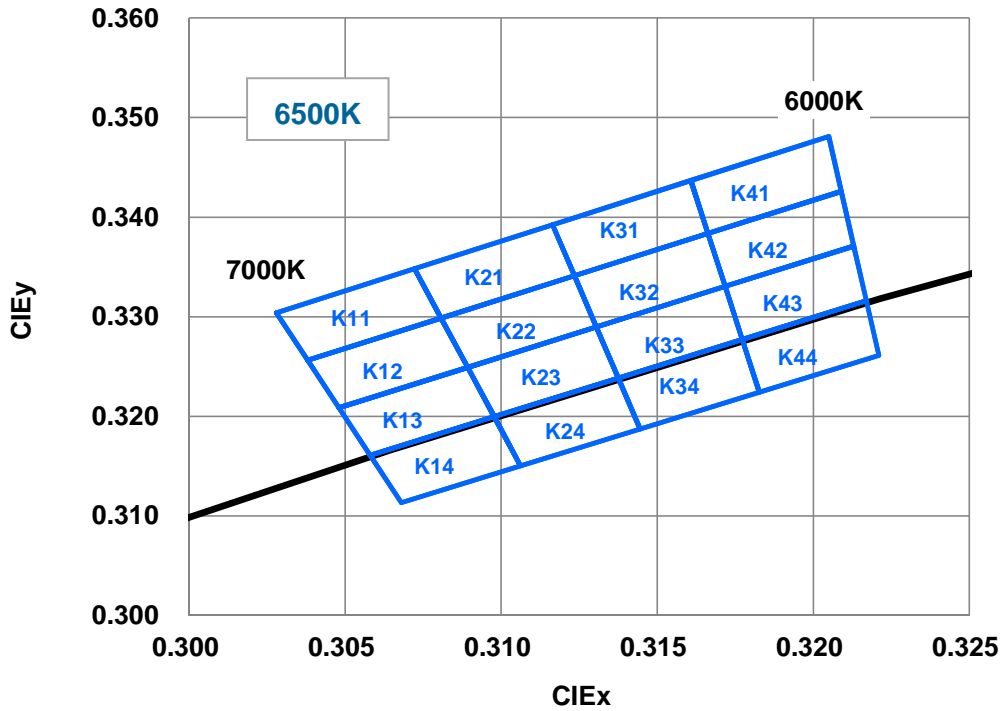

Specific lighting
LTW-5630AZLxx-EU

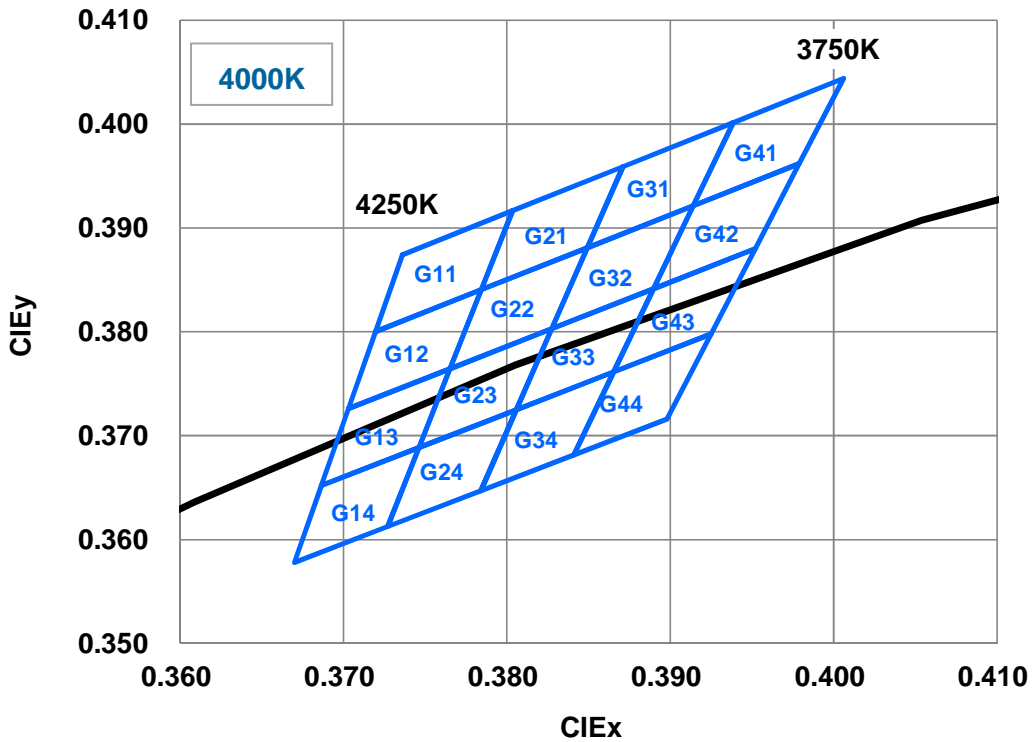
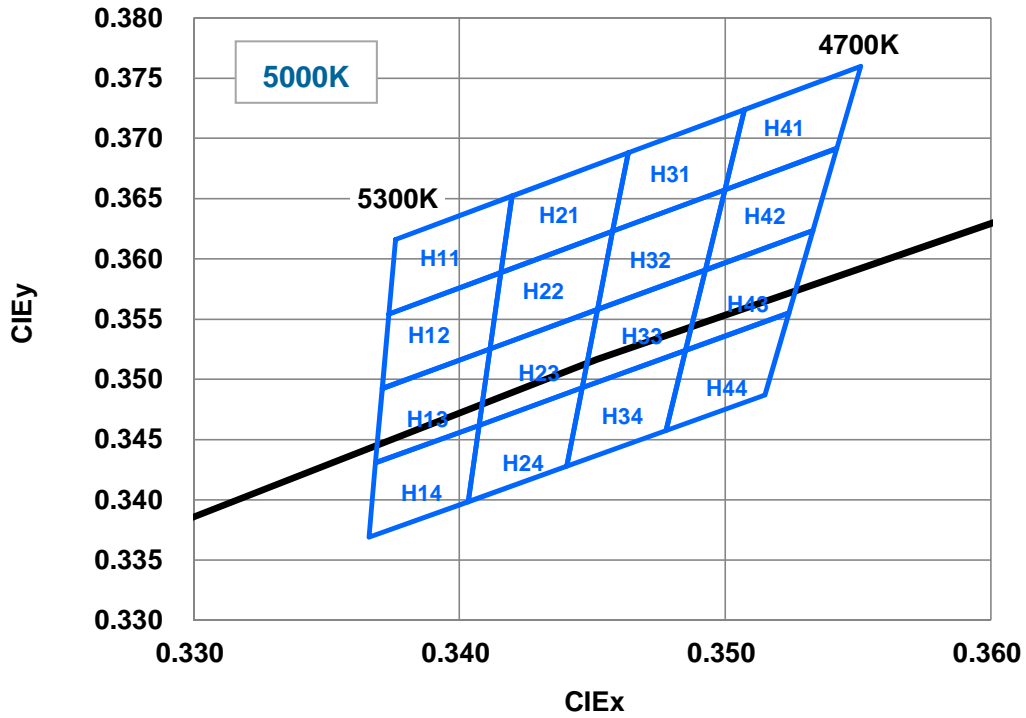

Specific lighting
LTW-5630AZLxx-EU

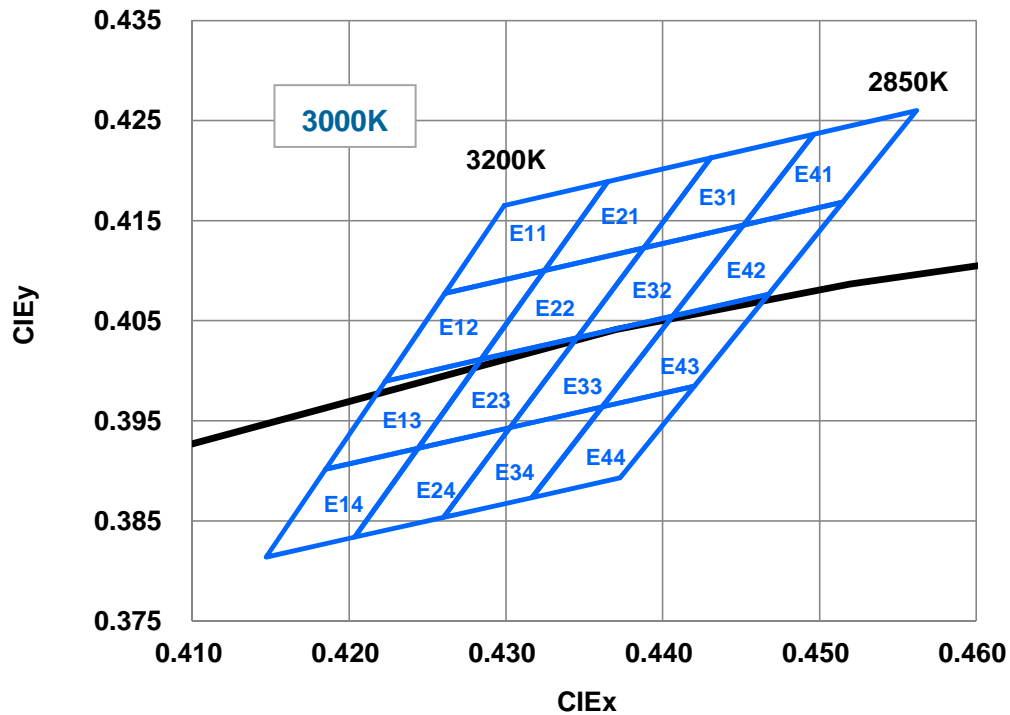
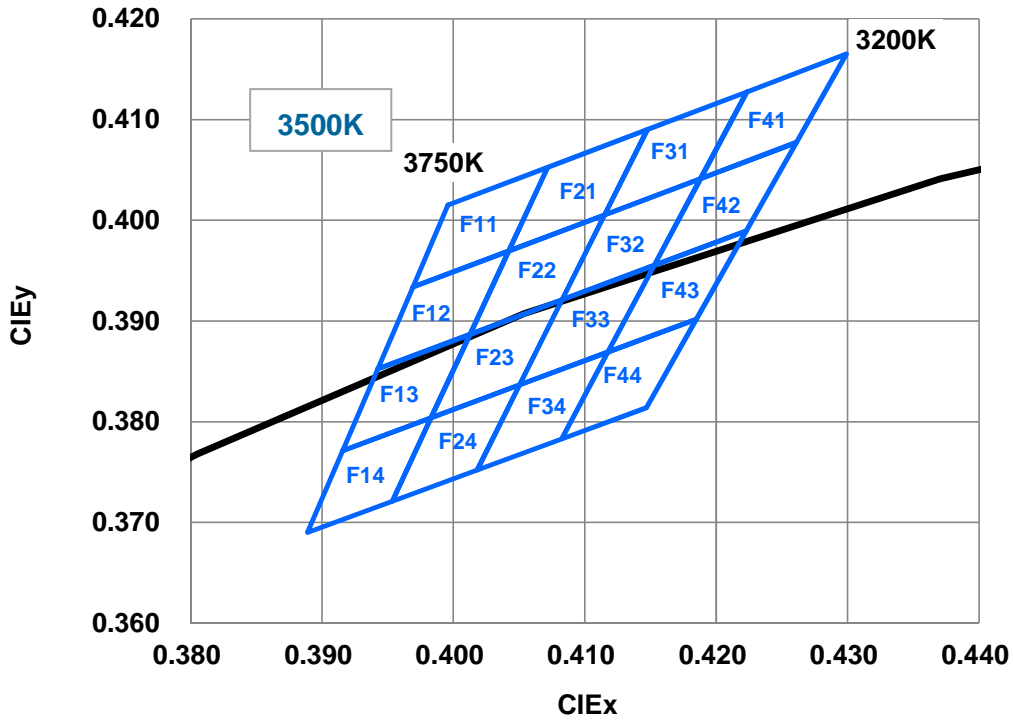

Specific lighting
LTW-5630AZLxx-EU

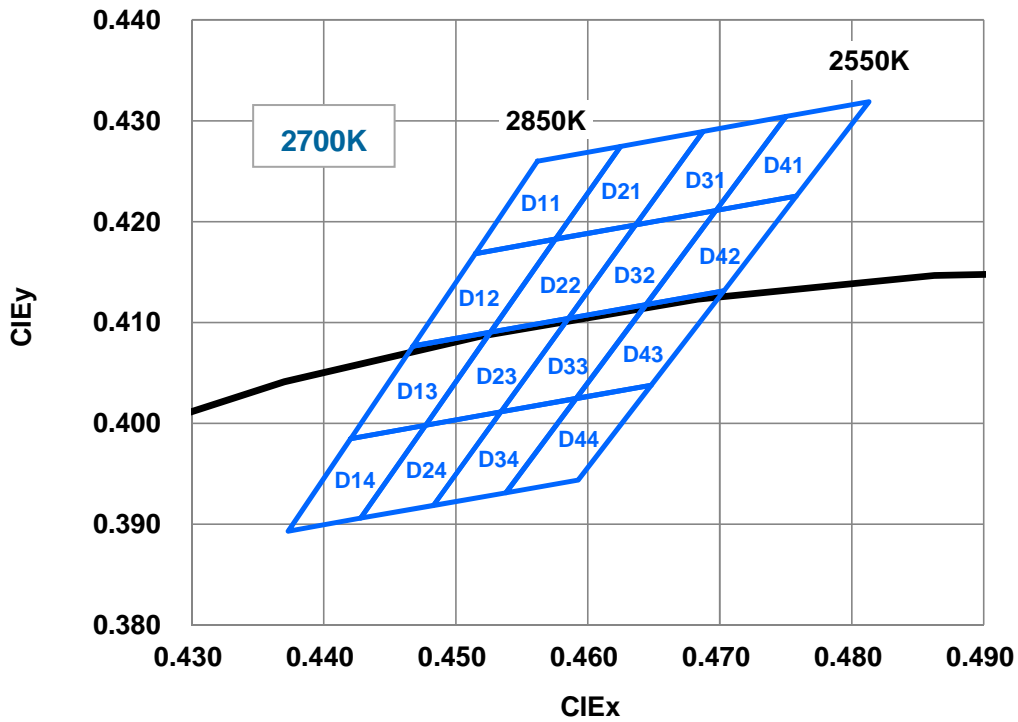

Specific lighting LTW-5630AZLxx-EU

5.2 Color Rank

6500K (IF = 120 mA)															
Rank	-	x	y	Rank	-	x	y	Rank	-	x	y	Rank	-	x	y
K11	1	0.3028	0.3304	K21	1	0.3072	0.3348	K31	1	0.3117	0.3393	K41	1	0.3161	0.3437
	2	0.3038	0.3256		2	0.3081	0.3299		2	0.3124	0.3341		2	0.3166	0.3384
	3	0.3081	0.3299		3	0.3124	0.3341		3	0.3166	0.3384		3	0.3209	0.3426
	4	0.3072	0.3348		4	0.3117	0.3393		4	0.3161	0.3437		4	0.3205	0.3481
	1	0.3028	0.3304		1	0.3072	0.3348		1	0.3117	0.3393		1	0.3161	0.3437
K12	1	0.3038	0.3256	K22	1	0.3081	0.3299	K32	1	0.3124	0.3341	K42	1	0.3166	0.3384
	2	0.3048	0.3209		2	0.3089	0.3249		2	0.3131	0.3290		2	0.3172	0.3330
	3	0.3089	0.3249		3	0.3131	0.3290		3	0.3172	0.3330		3	0.3213	0.3371
	4	0.3081	0.3299		4	0.3124	0.3341		4	0.3166	0.3384		4	0.3209	0.3426
	1	0.3038	0.3256		1	0.3081	0.3299		1	0.3124	0.3341		1	0.3166	0.3384
K13	1	0.3048	0.3209	K23	1	0.3089	0.3249	K33	1	0.3131	0.3290	K43	1	0.3172	0.3330
	2	0.3058	0.3161		2	0.3098	0.3200		2	0.3138	0.3238		2	0.3177	0.3277
	3	0.3098	0.3200		3	0.3138	0.3238		3	0.3177	0.3277		3	0.3217	0.3316
	4	0.3089	0.3249		4	0.3131	0.3290		4	0.3172	0.3330		4	0.3213	0.3371
	1	0.3048	0.3209		1	0.3089	0.3249		1	0.3131	0.3290		1	0.3172	0.3330
K14	1	0.3058	0.3161	K24	1	0.3098	0.3200	K34	1	0.3138	0.3238	K44	1	0.3177	0.3277
	2	0.3068	0.3113		2	0.3106	0.3150		2	0.3145	0.3187		2	0.3183	0.3224
	3	0.3106	0.3150		3	0.3145	0.3187		3	0.3183	0.3224		3	0.3221	0.3261
	4	0.3098	0.3200		4	0.3138	0.3238		4	0.3177	0.3277		4	0.3217	0.3316
	1	0.3058	0.3161		1	0.3098	0.3200		1	0.3138	0.3238		1	0.3177	0.3277

Tolerance on each Hue bin (x,y) is +/- 0.01.

Specific lighting LTW-5630AZLxx-EU

5700K (IF = 120 mA)															
Rank	-	x	y	Rank	-	x	y	Rank	-	x	y	Rank	-	x	y
J11	1	0.3207	0.3462	J21	1	0.3249	0.3501	J31	1	0.3292	0.3539	J41	1	0.3334	0.3578
	2	0.3211	0.3407		2	0.3251	0.3444		2	0.3292	0.3481		2	0.3333	0.3518
	3	0.3251	0.3444		3	0.3292	0.3481		3	0.3333	0.3518		3	0.3374	0.3554
	4	0.3249	0.3501		4	0.3292	0.3539		4	0.3334	0.3578		4	0.3376	0.3616
	1	0.3207	0.3462		1	0.3249	0.3501		1	0.3292	0.3539		1	0.3334	0.3578
J12	1	0.3211	0.3407	J22	1	0.3251	0.3444	J32	1	0.3292	0.3481	J42	1	0.3333	0.3518
	2	0.3215	0.3353		2	0.3254	0.3388		2	0.3293	0.3423		2	0.3332	0.3458
	3	0.3254	0.3388		3	0.3293	0.3423		3	0.3332	0.3458		3	0.3371	0.3493
	4	0.3251	0.3444		4	0.3292	0.3481		4	0.3333	0.3518		4	0.3374	0.3554
	1	0.3211	0.3407		1	0.3251	0.3444		1	0.3292	0.3481		1	0.3333	0.3518
J13	1	0.3215	0.3353	J23	1	0.3254	0.3388	J33	1	0.3293	0.3423	J43	1	0.3332	0.3458
	2	0.3218	0.3298		2	0.3256	0.3331		2	0.3293	0.3364		2	0.3331	0.3398
	3	0.3256	0.3331		3	0.3293	0.3364		3	0.3331	0.3398		3	0.3369	0.3431
	4	0.3254	0.3388		4	0.3293	0.3423		4	0.3332	0.3458		4	0.3371	0.3493
	1	0.3215	0.3353		1	0.3254	0.3388		1	0.3293	0.3423		1	0.3332	0.3458
J14	1	0.3218	0.3298	J24	1	0.3256	0.3331	J34	1	0.3293	0.3364	J44	1	0.3331	0.3398
	2	0.3222	0.3243		2	0.3258	0.3275		2	0.3294	0.3306		2	0.3330	0.3338
	3	0.3258	0.3275		3	0.3294	0.3306		3	0.3330	0.3338		3	0.3366	0.3369
	4	0.3256	0.3331		4	0.3293	0.3364		4	0.3331	0.3398		4	0.3369	0.3431
	1	0.3218	0.3298		1	0.3256	0.3331		1	0.3293	0.3364		1	0.3331	0.3398

Tolerance on each Hue bin (x,y) is +/- 0.01.

Specific lighting
LTW-5630AZLxx-EU

5000K (IF = 120 mA)															
Rank	-	x	y	Rank	-	x	y	Rank	-	x	y	Rank	-	x	y
H11	1	0.3376	0.3616	H21	1	0.3420	0.3652	H31	1	0.3464	0.3688	H41	1	0.3507	0.3724
	2	0.3374	0.3554		2	0.3416	0.3589		2	0.3458	0.3623		2	0.3500	0.3657
	3	0.3416	0.3589		3	0.3458	0.3623		3	0.3500	0.3657		3	0.3542	0.3692
	4	0.3420	0.3652		4	0.3464	0.3688		4	0.3507	0.3724		4	0.3551	0.3760
	1	0.3376	0.3616		1	0.3420	0.3652		1	0.3464	0.3688		1	0.3507	0.3724
H12	1	0.3374	0.3554	H22	1	0.3416	0.3589	H32	1	0.3458	0.3623	H42	1	0.3500	0.3657
	2	0.3371	0.3493		2	0.3412	0.3525		2	0.3452	0.3558		2	0.3493	0.3591
	3	0.3412	0.3525		3	0.3452	0.3558		3	0.3493	0.3591		3	0.3533	0.3624
	4	0.3416	0.3589		4	0.3458	0.3623		4	0.3500	0.3657		4	0.3542	0.3692
	1	0.3374	0.3554		1	0.3416	0.3589		1	0.3458	0.3623		1	0.3500	0.3657
H13	1	0.3371	0.3493	H23	1	0.3412	0.3525	H33	1	0.3452	0.3558	H43	1	0.3493	0.3591
	2	0.3369	0.3431		2	0.3407	0.3462		2	0.3446	0.3493		2	0.3485	0.3524
	3	0.3407	0.3462		3	0.3446	0.3493		3	0.3485	0.3524		3	0.3524	0.3555
	4	0.3412	0.3525		4	0.3452	0.3558		4	0.3493	0.3591		4	0.3533	0.3624
	1	0.3371	0.3493		1	0.3412	0.3525		1	0.3452	0.3558		1	0.3493	0.3591
H14	1	0.3369	0.3431	H24	1	0.3407	0.3462	H34	1	0.3446	0.3493	H44	1	0.3485	0.3524
	2	0.3366	0.3369		2	0.3403	0.3399		2	0.3441	0.3428		2	0.3478	0.3458
	3	0.3403	0.3399		3	0.3441	0.3428		3	0.3478	0.3458		3	0.3515	0.3487
	4	0.3407	0.3462		4	0.3446	0.3493		4	0.3485	0.3524		4	0.3524	0.3555
	1	0.3369	0.3431		1	0.3407	0.3462		1	0.3446	0.3493		1	0.3485	0.3524

Tolerance on each Hue bin (x,y) is +/- 0.01.

Specific lighting LTW-5630AZLxx-EU

4000K (IF = 120 mA)															
Rank	-	x	y	Rank	-	x	y	Rank	-	x	y	Rank	-	x	y
G11	1	0.3736	0.3874	G21	1	0.3804	0.3917	G31	1	0.3871	0.3959	G41	1	0.3939	0.4002
	2	0.3720	0.3800		2	0.3784	0.3841		2	0.3849	0.3881		2	0.3914	0.3922
	3	0.3784	0.3841		3	0.3849	0.3881		3	0.3914	0.3922		3	0.3979	0.3962
	4	0.3804	0.3917		4	0.3871	0.3959		4	0.3939	0.4002		4	0.4006	0.4044
	1	0.3736	0.3874		1	0.3804	0.3917		1	0.3871	0.3959		1	0.3939	0.4002
G12	1	0.3720	0.3800	G22	1	0.3784	0.3841	G32	1	0.3849	0.3881	G42	1	0.3914	0.3922
	2	0.3703	0.3726		2	0.3765	0.3765		2	0.3828	0.3803		2	0.3890	0.3842
	3	0.3765	0.3765		3	0.3828	0.3803		3	0.3890	0.3842		3	0.3952	0.3880
	4	0.3784	0.3841		4	0.3849	0.3881		4	0.3914	0.3922		4	0.3979	0.3962
	1	0.3720	0.3800		1	0.3784	0.3841		1	0.3849	0.3881		1	0.3914	0.3922
G13	1	0.3703	0.3726	G23	1	0.3765	0.3765	G33	1	0.3828	0.3803	G43	1	0.3890	0.3842
	2	0.3687	0.3652		2	0.3746	0.3689		2	0.3806	0.3725		2	0.3865	0.3762
	3	0.3746	0.3689		3	0.3806	0.3725		3	0.3865	0.3762		3	0.3925	0.3798
	4	0.3765	0.3765		4	0.3828	0.3803		4	0.3890	0.3842		4	0.3952	0.3880
	1	0.3703	0.3726		1	0.3765	0.3765		1	0.3828	0.3803		1	0.3890	0.3842
G14	1	0.3687	0.3652	G24	1	0.3746	0.3689	G34	1	0.3806	0.3725	G44	1	0.3865	0.3762
	2	0.3670	0.3578		2	0.3727	0.3613		2	0.3784	0.3647		2	0.3841	0.3682
	3	0.3727	0.3613		3	0.3784	0.3647		3	0.3841	0.3682		3	0.3898	0.3716
	4	0.3746	0.3689		4	0.3806	0.3725		4	0.3865	0.3762		4	0.3925	0.3798
	1	0.3687	0.3652		1	0.3746	0.3689		1	0.3806	0.3725		1	0.3865	0.3762

Tolerance on each Hue bin (x,y) is +/- 0.01.

Specific lighting LTW-5630AZLxx-EU

3500K (IF = 120 mA)															
Rank	-	x	y	Rank	-	x	y	Rank	-	x	y	Rank	-	x	y
F11	1	0.3996	0.4015	F21	1	0.4072	0.4053	F31	1	0.4148	0.4090	F41	1	0.4223	0.4128
	2	0.3969	0.3934		2	0.4042	0.3970		2	0.4115	0.4006		2	0.4188	0.4041
	3	0.4042	0.3970		3	0.4115	0.4006		3	0.4188	0.4041		3	0.4261	0.4077
	4	0.4072	0.4053		4	0.4148	0.4090		4	0.4223	0.4128		4	0.4299	0.4165
	1	0.3996	0.4015		1	0.4072	0.4053		1	0.4148	0.4090		1	0.4223	0.4128
F12	1	0.3969	0.3934	F22	1	0.4042	0.3970	F32	1	0.4115	0.4006	F42	1	0.4188	0.4041
	2	0.3943	0.3853		2	0.4013	0.3887		2	0.4083	0.3921		2	0.4153	0.3955
	3	0.4013	0.3887		3	0.4083	0.3921		3	0.4153	0.3955		3	0.4223	0.3990
	4	0.4042	0.3970		4	0.4115	0.4006		4	0.4188	0.4041		4	0.4261	0.4077
		1	0.3969		0.3934		1		0.4042	0.3970			1	0.4115	0.4006
F13	1	0.3943	0.3853	F23	1	0.4013	0.3887	F33	1	0.4083	0.3921	F43	1	0.4153	0.3955
	2	0.3916	0.3771		2	0.3983	0.3804		2	0.4050	0.3837		2	0.4118	0.3869
	3	0.3983	0.3804		3	0.4050	0.3837		3	0.4118	0.3869		3	0.4185	0.3902
	4	0.4013	0.3887		4	0.4083	0.3921		4	0.4153	0.3955		4	0.4223	0.3990
		1	0.3943		0.3853		1		0.4013	0.3887			1	0.4083	0.3921
F14	1	0.3916	0.3771	F24	1	0.3983	0.3804	F34	1	0.4050	0.3837	F44	1	0.4118	0.3869
	2	0.3889	0.3690		2	0.3954	0.3721		2	0.4018	0.3752		2	0.4083	0.3783
	3	0.3954	0.3721		3	0.4018	0.3752		3	0.4083	0.3783		3	0.4147	0.3814
	4	0.3983	0.3804		4	0.4050	0.3837		4	0.4118	0.3869		4	0.4185	0.3902
		1	0.3916		0.3771		1		0.3983	0.3804			1	0.4050	0.3837

Tolerance on each Hue bin (x,y) is +/- 0.01.

Specific lighting LTW-5630AZLxx-EU

3000K (IF = 120 mA)															
Rank	-	x	y	Rank	-	x	y	Rank	-	x	y	Rank	-	x	y
E11	1	0.4299	0.4165	E21	1	0.4365	0.4189	E31	1	0.4431	0.4213	E41	1	0.4496	0.4236
	2	0.4261	0.4077		2	0.4324	0.4100		2	0.4388	0.4123		2	0.4451	0.4146
	3	0.4324	0.4100		3	0.4388	0.4123		3	0.4451	0.4146		3	0.4515	0.4168
	4	0.4365	0.4189		4	0.4431	0.4213		4	0.4496	0.4236		4	0.4562	0.4260
	1	0.4299	0.4165		1	0.4365	0.4189		1	0.4431	0.4213		1	0.4496	0.4236
E12	1	0.4261	0.4077	E22	1	0.4324	0.4100	E32	1	0.4388	0.4123	E42	1	0.4451	0.4146
	2	0.4223	0.3990		2	0.4284	0.4011		2	0.4345	0.4033		2	0.4406	0.4055
	3	0.4284	0.4011		3	0.4345	0.4033		3	0.4406	0.4055		3	0.4468	0.4077
	4	0.4324	0.4100		4	0.4388	0.4123		4	0.4451	0.4146		4	0.4515	0.4168
	1	0.4261	0.4077		1	0.4324	0.4100		1	0.4388	0.4123		1	0.4451	0.4146
E13	1	0.4223	0.3990	E23	1	0.4284	0.4011	E33	1	0.4345	0.4033	E43	1	0.4406	0.4055
	2	0.4185	0.3902		2	0.4244	0.3923		2	0.4303	0.3943		2	0.4361	0.3964
	3	0.4244	0.3923		3	0.4303	0.3943		3	0.4361	0.3964		3	0.4420	0.3985
	4	0.4284	0.4011		4	0.4345	0.4033		4	0.4406	0.4055		4	0.4468	0.4077
	1	0.4223	0.3990		1	0.4284	0.4011		1	0.4345	0.4033		1	0.4406	0.4055
E14	1	0.4185	0.3902	E24	1	0.4244	0.3923	E34	1	0.4303	0.3943	E44	1	0.4361	0.3964
	2	0.4147	0.3814		2	0.4204	0.3834		2	0.4260	0.3854		2	0.4317	0.3873
	3	0.4204	0.3834		3	0.4260	0.3854		3	0.4317	0.3873		3	0.4373	0.3893
	4	0.4244	0.3923		4	0.4303	0.3943		4	0.4361	0.3964		4	0.4420	0.3985
	1	0.4185	0.3902		1	0.4244	0.3923		1	0.4303	0.3943		1	0.4361	0.3964

Tolerance on each Hue bin (x,y) is +/- 0.01.

Specific lighting LTW-5630AZLxx-EU

2700K (IF = 120 mA)															
Rank	-	x	y	Rank	-	x	y	Rank	-	x	y	Rank	-	x	y
D11	1	0.4562	0.4260	D21	1	0.4625	0.4275	D31	1	0.4688	0.4290	D41	1	0.4750	0.4304
	2	0.4515	0.4168		2	0.4576	0.4183		2	0.4636	0.4197		2	0.4697	0.4211
	3	0.4576	0.4183		3	0.4636	0.4197		3	0.4697	0.4211		3	0.4758	0.4225
	4	0.4625	0.4275		4	0.4688	0.4290		4	0.4750	0.4304		4	0.4813	0.4319
	1	0.4562	0.4260		1	0.4625	0.4275		1	0.4688	0.4290		1	0.4750	0.4304
D12	1	0.4515	0.4168	D22	1	0.4576	0.4183	D32	1	0.4636	0.4197	D42	1	0.4697	0.4211
	2	0.4468	0.4077		2	0.4526	0.4090		2	0.4585	0.4104		2	0.4644	0.4118
	3	0.4526	0.4090		3	0.4585	0.4104		3	0.4644	0.4118		3	0.4703	0.4132
	4	0.4576	0.4183		4	0.4636	0.4197		4	0.4697	0.4211		4	0.4758	0.4225
	1	0.4515	0.4168		1	0.4576	0.4183		1	0.4636	0.4197		1	0.4697	0.4211
D13	1	0.4468	0.4077	D23	1	0.4526	0.4090	D33	1	0.4585	0.4104	D43	1	0.4644	0.4118
	2	0.4420	0.3985		2	0.4477	0.3998		2	0.4534	0.4011		2	0.4591	0.4025
	3	0.4477	0.3998		3	0.4534	0.4011		3	0.4591	0.4025		3	0.4648	0.4038
	4	0.4526	0.4090		4	0.4585	0.4104		4	0.4644	0.4118		4	0.4703	0.4132
	1	0.4468	0.4077		1	0.4526	0.4090		1	0.4585	0.4104		1	0.4644	0.4118
D14	1	0.4420	0.3985	D24	1	0.4477	0.3998	D34	1	0.4534	0.4011	D44	1	0.4591	0.4025
	2	0.4373	0.3893		2	0.4428	0.3906		2	0.4483	0.3919		2	0.4538	0.3931
	3	0.4428	0.3906		3	0.4483	0.3919		3	0.4538	0.3931		3	0.4593	0.3944
	4	0.4477	0.3998		4	0.4534	0.4011		4	0.4591	0.4025		4	0.4648	0.4038
	1	0.4420	0.3985		1	0.4477	0.3998		1	0.4534	0.4011		1	0.4591	0.4025

Tolerance on each Hue bin (x,y) is +/- 0.01.

Specific lighting LTW-5630AZLxx-EU

5.3 Flux Bin

2700K	Φ_v Luminous Flux Spec. Table	
Φ_v Bin	Lumen (lm) at $I_F = 120$ mA	
	Min	Max
CF	41.0	45.5
FI	45.5	50.0
IL	50.0	54.5
LO	54.5	59.0
OR	59.0	63.5
3000K	Φ_v Luminous Flux Spec. Table	
Φ_v Bin	Lumen (lm) at $I_F = 120$ mA	
	Min	Max
DG	42.5	47.0
GJ	47.0	51.5
JM	51.5	56.0
MP	56.0	60.5
PS	60.5	65
3500K	Φ_v Luminous Flux Spec. Table	
Φ_v Bin	Lumen (lm) at $I_F = 120$ mA	
	Min	Max
EH	44.0	48.5
HK	48.5	53.0
KN	53.0	57.5
NQ	57.5	62.0
QT	62.0	66.5

4000K	Φ_v Luminous Flux Spec. Table	
Φ_v Bin	Lumen (lm) at $I_F = 120$ mA	
	Min	Max
EH	44.0	48.5
HK	48.5	53.0
KN	53.0	57.5
NQ	57.5	62.0
QT	62.0	66.5
5000K	Φ_v Luminous Flux Spec. Table	
Φ_v Bin	Lumen (lm) at $I_F = 120$ mA	
	Min	Max
FI	45.5	50.0
IL	50.0	54.5
LO	54.5	59.0
OR	59.0	63.5
RU	63.5	68.0
5700K	Φ_v Luminous Flux Spec. Table	
Φ_v Bin	Lumen (lm) at $I_F = 120$ mA	
	Min	Max
EH	44.0	48.5
HK	48.5	53.0
KN	53.0	57.5
NQ	57.5	62.0
QT	62.0	66.5
6500K	Φ_v Luminous Flux Spec. Table	
Φ_v Bin	Lumen (lm) at $I_F = 120$ mA	
	Min	Max
DG	42.5	47.0
GJ	47.0	51.5
JM	51.5	56.0
MP	56.0	60.5
PS	60.5	65.0

Tolerance on each Luminous Flux bin is +/- 10%.

Specific lighting LTW-5630AZLxx-EU

$I_F = 120 \text{ mA}$		CCT						
Code	Im	2700K	3000K	3500K	4000K	5000K	5700K	6500K
C	41.0							
D	42.5	CF	DG					
E	44.0							
F	45.5	FI	GJ	EH	EH	FI	EH	DG
G	47.0							
H	48.5	IL	JM	HK	HK	IL	HK	GJ
I	50.0							
J	51.5	LO	MP	KN	KN	LO	KN	JM
K	53.0							
L	54.5	OR	PS	KN	KN	LO	KN	MP
M	56.0							
N	57.5	OR	PS	NQ	NQ	OR	NQ	MP
O	59.0							
P	60.5	OR	PS	NQ	NQ	OR	NQ	PS
Q	62.0							
R	63.5	RU		QT	QT	RU	QT	
S	65.0							
T	66.5	RU		QT	QT	RU	QT	
U	68.0							

Specific lighting LTW-5630AZLxx-EU

5.4 Voltage Bin

V _F Spec. Table		
V _F Bin	Forward Voltage (volts) at I _F = 120mA	
	Min	Max
VA	2.8	2.9
V0	2.9	3.0
V1	3.0	3.1
V2	3.1	3.2
V3	3.2	3.3

Tolerance on each Forward Voltage bin is +/- 0.1V

6. Bin Code List

※ Notes: Full Rank on Label

Example: V1 / HK / G33

Forward Voltage Rank	Luminous Flux Rank	Color Rank
V1	HK	G33

Specific lighting LTW-5630AZLxx-EU

7. Reflow Soldering Characteristics

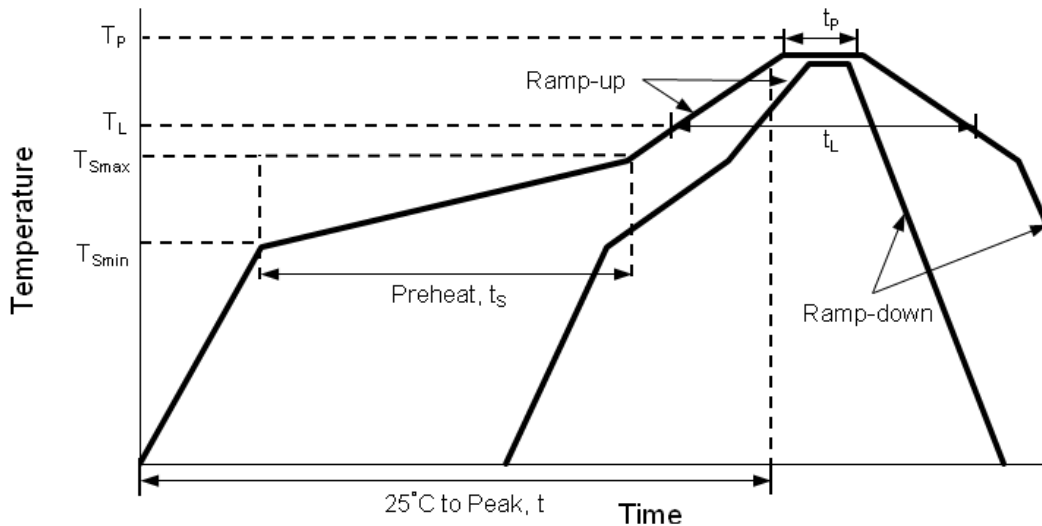

Profile Feature	Lead Free Assembly
Average Ramp-Up Rate (T_{Smax} to T_P)	3°C / second max
Preheat Temperature Min (T_{Smin})	150°C
Preheat Temperature Max (T_{Smax})	200°C
Preheat Time (t_{Smin} to t_{Smax})	60 – 180 seconds
Time Maintained Above Temperature (T_L)	217°C
Time Maintained Above Time (t_L)	60 – 150 seconds
Peak / Classification Temperature (T_P)	260°C
Time Within 5°C of Actual Peak Temperature (t_p)	5 seconds
Ramp – Down Rate	6°C / second max
Time 25°C to Peak Temperature	8 minutes max

Notes:

- The LEDs can be soldered using the reflow soldering or hand soldering method. The recommended hand soldering condition is 350 °C max. and 2 secs max. for one time only, and the recommended reflow soldering condition is 260 °C max. and 5 secs max. for three times max.
- All temperatures refer to topside of the package, measured on the package body surface.

Specific lighting LTW-5630AZLxx-EU

3. The soldering condition referring to J-STD-020B. The storage ambient for the LEDs should not exceed 30 °C temperature or 70% relative humidity. It is recommended that LEDs out of their original packaging are soldered within one week. For extended storage out of their original packaging, it is recommended that the LEDs were stored in a sealed container with appropriate desiccant, or desiccators with nitrogen ambient. If the LEDs were unpacked more than 168hrs, baking the LEDs at 60 °C for 24hrs before soldering process.
4. The soldering profile could be further referred to different soldering grease material characteristic. The grease vendor will provide this information.
5. A rapid-rate process is not recommended for the LEDs cooling down from the peak temperature.
6. Although the recommended reflow conditions are specified above, the reflow or hand soldering condition at the lowest possible temperature is desirable for the LEDs.
7. LiteOn cannot make a guarantee on the LEDs which have been already assembled using the dip soldering method.

Specific lighting LTW-5630AZLxx-EU

8. Reliability Test

No	Test item	Test Condition	Duration	Number of Damaged
1	Steady State Operating Life of High Temperature (HTOL)	Ts=55°C, I _F =120mA	1000 hrs	0/20
2	Steady State Operating Life of High Temperature (HTOL)	Ts=85°C, I _F =120mA	1000 hrs	0/20
3	Steady State Operating Life of High Temperature (HTOL)	Ts=55°C, I _F =180mA	1000 hrs	0/20
4	Steady State Operating Life of High Temperature (HTOL)	Ts=85°C, I _F =180mA	1000 hrs	0/20
5	Steady State Operating Life of Low Temperature (LTOL)	Ta=-40°C, I _F =120mA	1000 hrs	0/20
6	Pulse Wet Operating Life of High Temperature (PWHTOL)	60°C/90%RH, I _F =120mA 30mins ON/30min OFF	500 hrs	0/20
7	High Temperature Storage (HTS)	100°C	1000 hrs	0/20
8	Low Temperature Storage (LTS)	-40°C	1000 hrs	0/20
9	Thermal Cycle (TC)	-40°C~100°C 30min dwell 5min transfer	200 cycle	0/20
10	Thermal Shock (TS)	-40°C~100°C 20min dwell 20sec transfer	200 cycle	0/20
11	Solder Resistance (SR)	265°C, 3X MSL	5sec	0/20
12	Solder Ability (SA)	245°C5sec, 95% coverage	5sec	0/11
13	Salt Spread (SS)	35°C, 30g/m ² /day	48hrs	0/11

■ Criteria for Judging the Damage

Item	Symbol	Test Condition	Criteria for Judgment	
			Min.	Max.
Forward Voltage	V _F	I _F =Typical Current		U.S.L. x 1.1
Luminous Flux	Im	I _F =Typical Current	L.S.L. x 0.7	
CCX&CCY	x,y	I _F =Typical Current		Shift<0.02

Specific lighting LTW-5630AZLxx-EU

9. User Guide

■ Cleaning

Do not use unspecified chemical liquid to clean LED they could harm the package. If cleaning is necessary, immerse the LED in ethyl alcohol or isopropyl alcohol at normal temperature for less than one minute.

■ Recommend Printed Circuit Board Attachment Pad

Infrared / vapor phase

Reflow Soldering

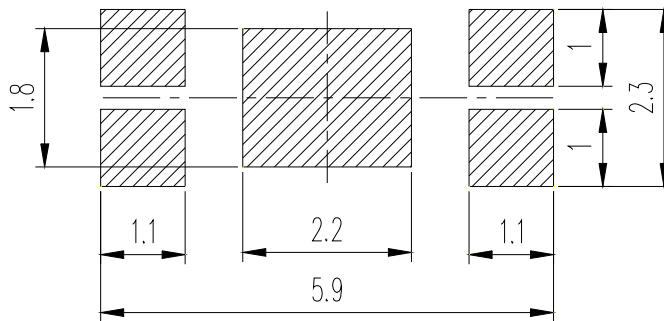

■ Package Dimensions of Tape

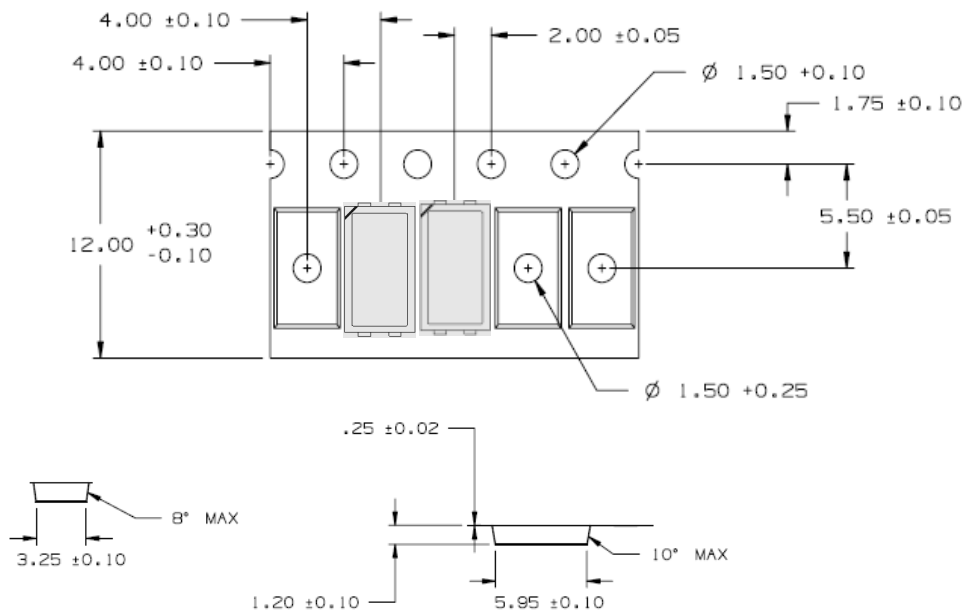

Note: All dimensions are in millimeters (inches).

**Specific lighting
LTW-5630AZLxx-EU**

■ Package Dimensions of Reel

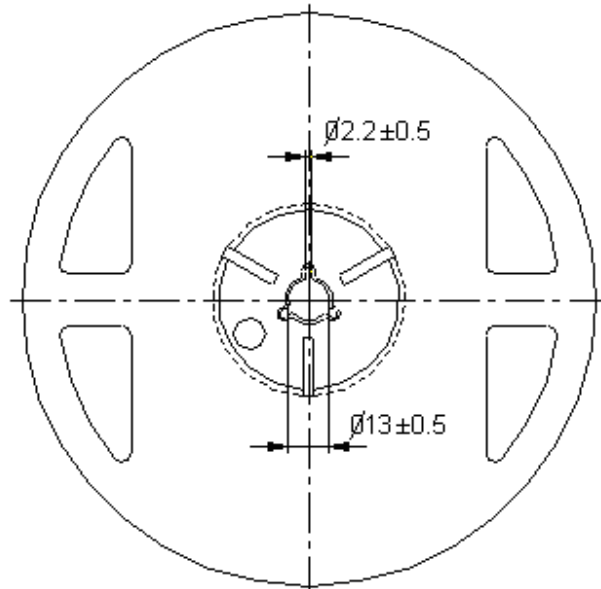

Note: 01. The tolerance unless mentioned is ± 0.1 mm
02. The measured unit is "mm"

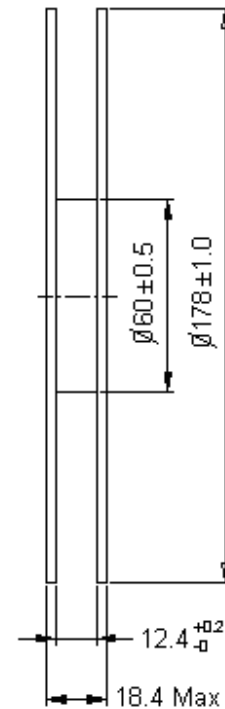

Notes:

1. Empty component pockets sealed with top cover tape.
2. 7 inch reel-3000 pieces per reel.
3. Minimum packing quantity is 500 pieces for remainders (Minimum packing quantity is 2000 pieces for remainders for LTW-5630AZL40-EU).
4. The maximum number of consecutive missing lamps is two.
5. In accordance with EIA-481-1-B specifications.

**Specific lighting
LTW-5630AZLxx-EU**

10. Cautions

10.1 Application

The LEDs described here are intended to be used for ordinary electronic equipment (such as office equipment, communication equipment and household applications). Consult Liteon’s Sales in advance for information on applications in which exceptional reliability is required, particularly when the failure or malfunction of the LEDs may directly jeopardize life or health (such as in aviation, transportation, traffic control equipment, medical and life support systems and safety devices).

10.2 Storage

This product is qualified as Moisture sensitive Level 3 per JEDEC J-STD-020 Precaution when handling this moisture sensitive product is important to ensure the reliability of the product.

The package is sealed:

The LEDs should be stored at 30°C or less and 90%RH or less. And the LEDs are limited to use within one year, while the LEDs is packed in moisture-proof package with the desiccants inside.

The package is opened:

The LEDs should be stored at 30°C or less and 60%RH or less. Moreover, the LEDs are limited to solder process within 168hrs. If exceeding the storage limiting time since opened, that we recommended to baking LEDs at 60°C at least 24hrs. To seal the remainder LEDs return to package, it’s recommended to be with workable desiccants in original package.

10.3 Cleaning

Use alcohol-based cleaning solvents such as isopropyl alcohol to clean the LED if necessary.

10.4 Drive Mode

An LED is a current-operated device. In order to ensure intensity uniformity on multiple LEDs connected in parallel in an application, it is recommended that a current limiting resistor be incorporated in the drive circuit, in series with each LED as shown in Circuit A below

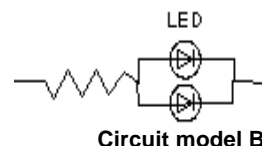
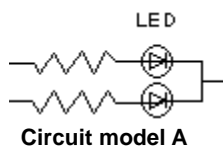

Specific lighting LTW-5630AZLxx-EU

(A) Recommended circuit.

(B) The brightness of each LED might appear different due to the differences in the I-V characteristics of those LEDs.

10.5 ESD (Electrostatic Discharge)

Static Electricity or power surge will damage the LED. Suggestions to prevent ESD damage:

- Use of a conductive wrist band or anti-electrostatic glove when handling these LEDs.
- All devices, equipment, and machinery must be properly grounded.
- Work tables, storage racks, etc. should be properly grounded.
- Use ion blower to neutralize the static charge which might have built up on surface of the LED's plastic lens as a result of friction between LEDs during storage and handling.

ESD-damaged LEDs will exhibit abnormal characteristics such as high reverse leakage current, low forward voltage, or "no lightup" at low currents. To verify for ESD damage, check for "light up" and V_F of the suspect LEDs at low currents. The V_F of "good" LEDs should be $>2.0V@0.1mA$ for InGaN product and $>1.4V@0.1mA$ for AlInGaP product.

10.6 Suggested Checking List:

- Training and Certification
 1. Everyone working in a static-safe area is ESD-certified?
 2. Training records kept and re-certification dates monitored?
- Static-Safe Workstation & Work Areas
 1. Static-safe workstation or work-areas have ESD signs?
 2. All surfaces and objects at all static-safe workstation and within 1 ft measure less than 100V?
 3. All ionizer activated, positioned towards the units?
 4. Each work surface mats grounding is good?
- Personnel Grounding
 1. Every person (including visitors) handling ESD sensitive (ESDS) items wear wrist strap, heel strap or conductive shoes with conductive flooring?
 2. If conductive footwear used, conductive flooring also present where operator stand or walk?

Specific lighting LTW-5630AZLxx-EU

3. Garments, hairs or anything closer than 1 ft to ESD items measure less than 100V*?
4. Every wrist strap or heel strap/conductive shoes checked daily and result recorded for all DLs?
5. All wrist strap or heel strap checkers calibration up to date?

Note: *50V for Blue LED.

- Device Handling
 1. Every ESDS items identified by EIA-471 labels on item or packaging?
 2. All ESDS items completely inside properly closed static-shielding containers when not at static-safe workstation?
 3. No static charge generators (e.g. plastics) inside shielding containers with ESDS items?
 4. All flexible conductive and dissipative package materials inspected before reuse or recycle?
- Others
 1. Audit result reported to entity ESD control coordinator?
 2. Corrective action from previous audits completed?
 3. Are audit records complete and on file?

10.7 Others:

- Do not put any pressure on the light emitting surface either by finger or any hand tool and do not stack the products. Stress or pressure may cause damage to the wires of the LED array.
- This product is not designed for the use under any of the following conditions, please confirm the performance and reliability are well enough if you use it under any of the following conditions
- Do not use sulfur-containing materials in commercial products including the materials such as seals and adhesives that may contain sulfur.
- Do not put this product in a place with a lot of moisture (over 85% relative humidity), dew condensation, briny air, and corrosive gas (Cl, H₂S, NH₃, SO₂, NO_x, etc.), exposure to a corrosive environment may affect silver plating.
- The appearance and specifications of the product may be modified for improvement without prior notice.

**Specific lighting
LTW-5630AZLxx-EU**

Revision History:

Revision Date:

Version	Page	Content of Change	Date Record
0		Preliminary Version	2014.06.11
3	P.21~ P.22	Adding one higher flux bin.	2015.05.07
4	P27	4000K min packing 2Kpcs	2016.02.25
5	P2	New 5630 lead frame	2016.07.25
6	P4,5,6,8,23,26	Add Vf bin 2.8-2.9V and I-V curve, update new Reliability	2016.10.12