

CUSTOMER : _____.

DATE : Mar. 15, 2018 .

REV : REV. 1.0 _____.

SPECIFICATIONS FOR APPROVAL

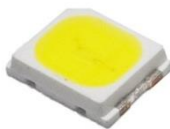



3528 B105N

MODEL NAME : LEMWS28U80◇SZE0N Series

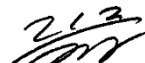

APPROVAL	REMARK	APPENDIX

DESIGNED	CHECKED	APPROVED
2018.03.15	2018.03.15	2018.03.15
I. J. Woo	D. H. Yu	J. H. Kim
		

CONTENTS

1. Features	3
2. Applications	3
3. Outline Dimensions	3
4. Absolute Maximum Ratings	4
5. Electro-Optical Characteristics	4~5
6. Flux Characteristics and Order Code	6
7. Chromaticity Bins	7 ~ 8
8. Typical Characteristic Curves	9 ~ 17
9. Reliability Test Items and Conditions	18
10. Packing and Labeling of Products	19 ~ 21
11. Cautions on Use	22 ~ 25
12. Disclaimers	25

1. Features

- Lighting Color : White
- Lead Frame Type LED Package : 2.8 x 3.5 x 0.70 (L x W x H) [Unit : mm]
- Viewing Angle : 120°
- Chip Material : InGaN
- Soldering Methods : Reflow soldering
- Taping : 8 mm conductive black carrier tape and antistatic clear cover tape
4,000 pcs/reel, Φ 178 mm reel

2. Application

- Interior Illumination

3. Outline Dimensions

(Unit : mm)

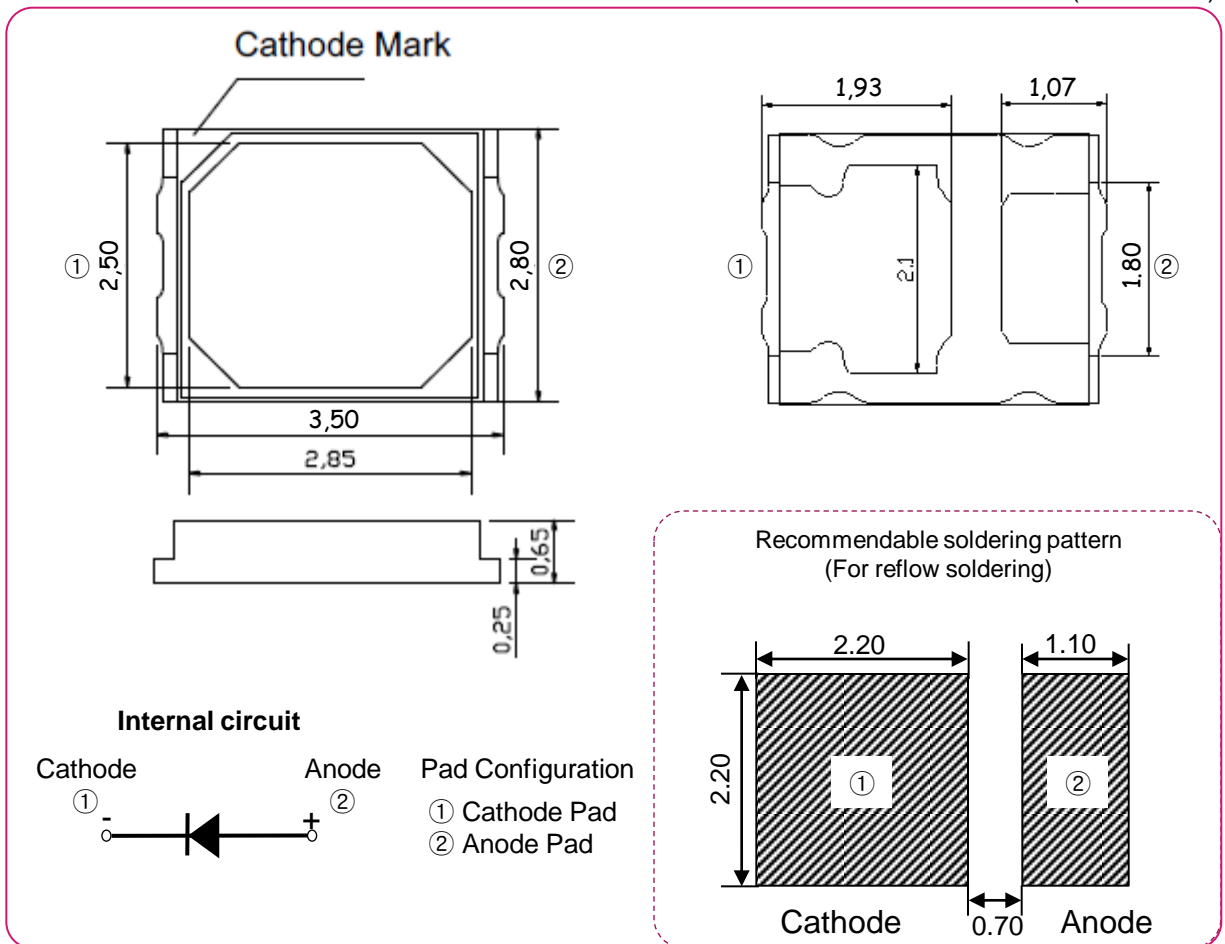

Tolerances unless otherwise mentioned are ± 0.10 mm

4. Absolute Maximum Ratings

(Ta=25°C)

Item	Symbol	Rating	Unit
Forward Current	If	180	mA
Pulse Forward Current* ¹⁾	Ifp	240	mA
Operating Temperature	Topr	-40 ~ +85	°C
Storage Temperature	Tstg	-40 ~ +100	°C
Junction Temperature	Tj	110	°C
Soldering Temperature	JEDEC-J-STD-020D		
ESD Classification	Class 2 (ANSI/ESDA/JEDEC JS-001)		

*1) Pulse width ≤10ms and duty cycle ≤10%

- ※ Operating the LED beyond the listed maximum ratings may affect device reliability and cause permanent damage. These or any other conditions beyond those indicated under recommended operating conditions are not implied. The exposure to the absolute maximum rated conditions may affect device reliability.
- ※ The LEDs are not designed to be driven in reverse bias.

5. Electro - Optical Characteristics

(Ta=25°C)

Item	Symbol	CCT	Luminous Flux @65mA			Unit
			Min.	Typ.	Max.	
Luminous Flux	Φv	6500 (F)	32.8	-	36.2	lm
		5700 (G)	32.8	-	36.2	
		5000 (H)	32.8	-	36.2	
		4000 (J)	32.8	-	36.2	
		3500 (K)	32.0	-	35.3	
		3000 (L)	30.8	-	34.1	
		2700 (M)	29.8	-	33.0	
Forward Voltage	Vf	All	2.6	-	3.1	V
Color Coordinate	Cx / Cy	All	Refer to '6. Bin Structures			-
Viewing Angle	2Θ1/2	All	-	120	-	deg
Color Rendering Index (CRI)	-	All	80.0	-	-	-
Thermal Resistance, Junction to Solder Point	Rth j-s	All	-	15	-	°C/W

- ※ These values are measured by the LG Innotek optical spectrum analyzer within the following tolerances. Luminous Flux (Φv) : ±7%, Forward Voltage (Vf) : ±0.1V, Color Value : ±0.005, CRI Value : ±2,
- ※ Although all LEDs are tested by LG Innotek equipment, some values may vary slightly depending on the conditions of the test equipment.

5. Electro - Optical Characteristics (Continued.)

(Ta=25°C)

CCT	If (mA)	Vf (V)	Power (W)	Φv (lm)	lm/W
6500K (F)	30	2.69	0.081	16.3	203
	65(Typ.)	2.80	0.182	34.5	190
	100	2.90	0.290	51.6	178
	150	3.03	0.454	74.4	164
	180	3.10	0.559	87.3	156
5700K (G)	30	2.69	0.081	16.3	203
	65(Typ.)	2.80	0.182	34.5	190
	100	2.90	0.290	51.6	178
	150	3.03	0.454	74.4	164
	180	3.10	0.559	87.3	156
5000K (H)	30	2.69	0.081	16.3	203
	65(Typ.)	2.80	0.182	34.5	190
	100	2.90	0.290	51.6	178
	150	3.03	0.454	74.4	164
	180	3.10	0.559	87.3	156
4000K (J)	30	2.69	0.081	16.3	203
	65(Typ.)	2.80	0.182	34.5	190
	100	2.90	0.290	51.6	178
	150	3.03	0.454	74.4	164
	180	3.10	0.559	87.3	156
3500K (K)	30	2.69	0.081	15.9	196
	65(Typ.)	2.80	0.182	33.6	185
	100	2.90	0.290	50.3	173
	150	3.03	0.454	72.5	160
	180	3.10	0.559	85.0	152
3000K (L)	30	2.69	0.081	15.3	189
	65(Typ.)	2.80	0.182	32.4	178
	100	2.90	0.290	48.5	167
	150	3.03	0.454	69.9	154
	180	3.10	0.559	82.0	147
2700K (M)	30	2.69	0.081	14.8	183
	65(Typ.)	2.80	0.182	31.4	173
	100	2.90	0.290	47.0	162
	150	3.03	0.454	67.7	149
	180	3.10	0.559	79.5	142

※ All the values in this table are for representative references only.

6. Flux Characteristics and Order Code

Color	CRI	CCT	Vf @ 65mA [V]	Luminous Flux [lm] @ 65mA			Order Code
				Bin Code	Min.	Max.	
Cool	80	6500 (F)	2.6 ~ 2.7 (7) 2.7 ~ 2.8 (8) 2.8 ~ 2.9 (9) 2.9 ~ 3.0 (0) 3.0 ~ 3.1 (1)	U3	32.8	36.2	LEMWS28U80FSZE0N
Cool	80	5700 (G)	2.6 ~ 2.7 (7) 2.7 ~ 2.8 (8) 2.8 ~ 2.9 (9) 2.9 ~ 3.0 (0) 3.0 ~ 3.1 (1)	U3	32.8	36.2	LEMWS28U80GSZE0N
Cool	80	5000 (H)	2.6 ~ 2.7 (7) 2.7 ~ 2.8 (8) 2.8 ~ 2.9 (9) 2.9 ~ 3.0 (0) 3.0 ~ 3.1 (1)	U3	32.8	36.2	LEMWS28U80HSZE0N
Neutral	80	4000 (J)	2.6 ~ 2.7 (7) 2.7 ~ 2.8 (8) 2.8 ~ 2.9 (9) 2.9 ~ 3.0 (0) 3.0 ~ 3.1 (1)	U3	32.8	36.2	LEMWS28U80JSZE0N
Warm	80	3500 (K)	2.6 ~ 2.7 (7) 2.7 ~ 2.8 (8) 2.8 ~ 2.9 (9) 2.9 ~ 3.0 (0) 3.0 ~ 3.1 (1)	U3	32.0	35.3	LEMWS28U80KSZE0N
Warm	80	3000 (L)	2.6 ~ 2.7 (7) 2.7 ~ 2.8 (8) 2.8 ~ 2.9 (9) 2.9 ~ 3.0 (0) 3.0 ~ 3.1 (1)	U3	30.8	34.1	LEMWS28U80LSZE0N
Warm	80	2700 (M)	2.6 ~ 2.7 (7) 2.7 ~ 2.8 (8) 2.8 ~ 2.9 (9) 2.9 ~ 3.0 (0) 3.0 ~ 3.1 (1)	U3	29.8	33.0	LEMWS28U80MSZE0N

※ Bin structure: Please refer to the following example.

Bin Code : U3-HE3-9

(Φv Bin = U3, Color Bin = HE3, Vf Bin = 9)

7. Chromaticity Bins (Cool White)

LG Innotek complies with the ANSI standard for its chromaticity bin structure.

LG Innotek provides Macadam “3~5-Step” ellipse from the chromaticity center at 65mA, Ta 25°C.

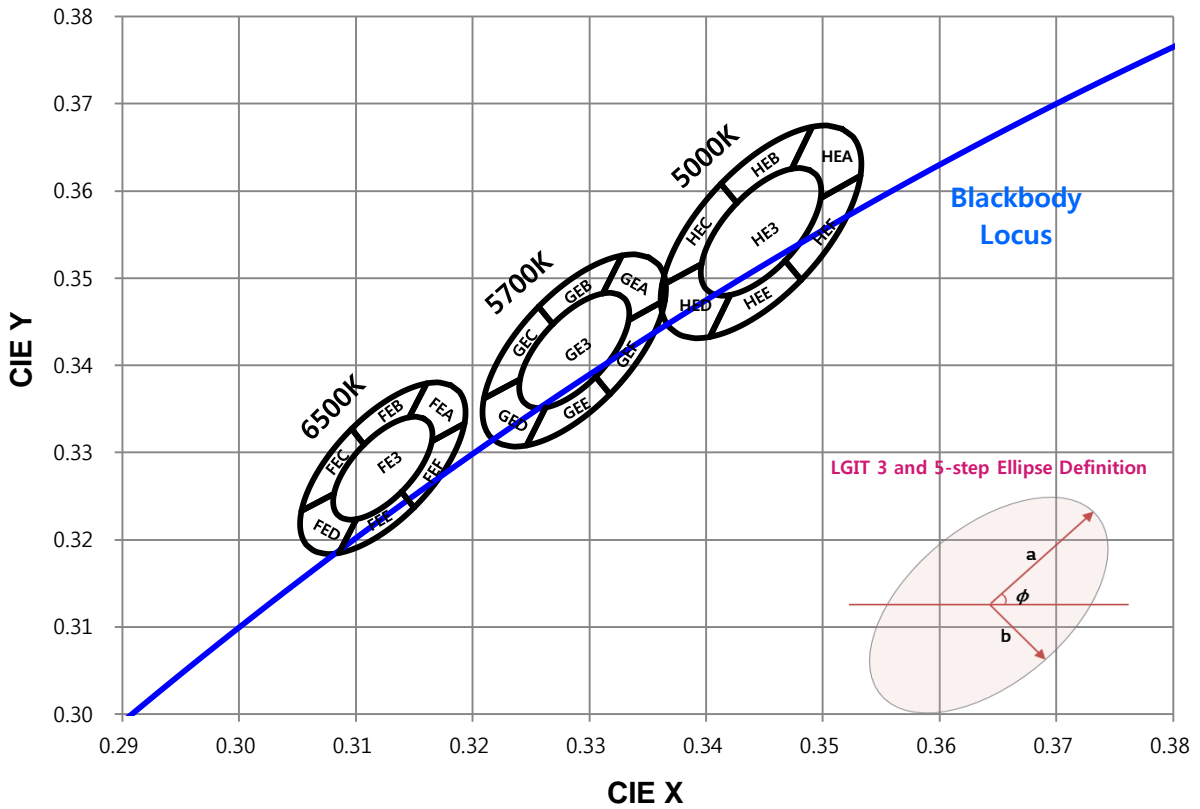

Nominal CCT (Rank)	Steps	Center Point		Major Axis	Minor Axis	Rotation Angle
		Cx	Cy	a	b	ϕ
5000K (HE3)	3	0.3447	0.3553	0.00822	0.00354	59.62
5000K (HEA-HEF)	5			0.01370	0.00590	
5700K (GE3)	3	0.3287	0.3417	0.00746	0.00320	59.09
5700K (GEA-GEF)	5			0.01243	0.00533	
6500K (FE3)	3	0.3123	0.3282	0.00669	0.00285	58.57
6500K (FEA-FEF)	5			0.01115	0.00475	

7. Chromaticity Bins (Continued. Warm White)

LG Innotek complies with the ANSI standard for its chromaticity bin structure.

LG Innotek provides Macadam “3~5-Step” ellipse from the chromaticity center at 65mA, Ta 25°C.

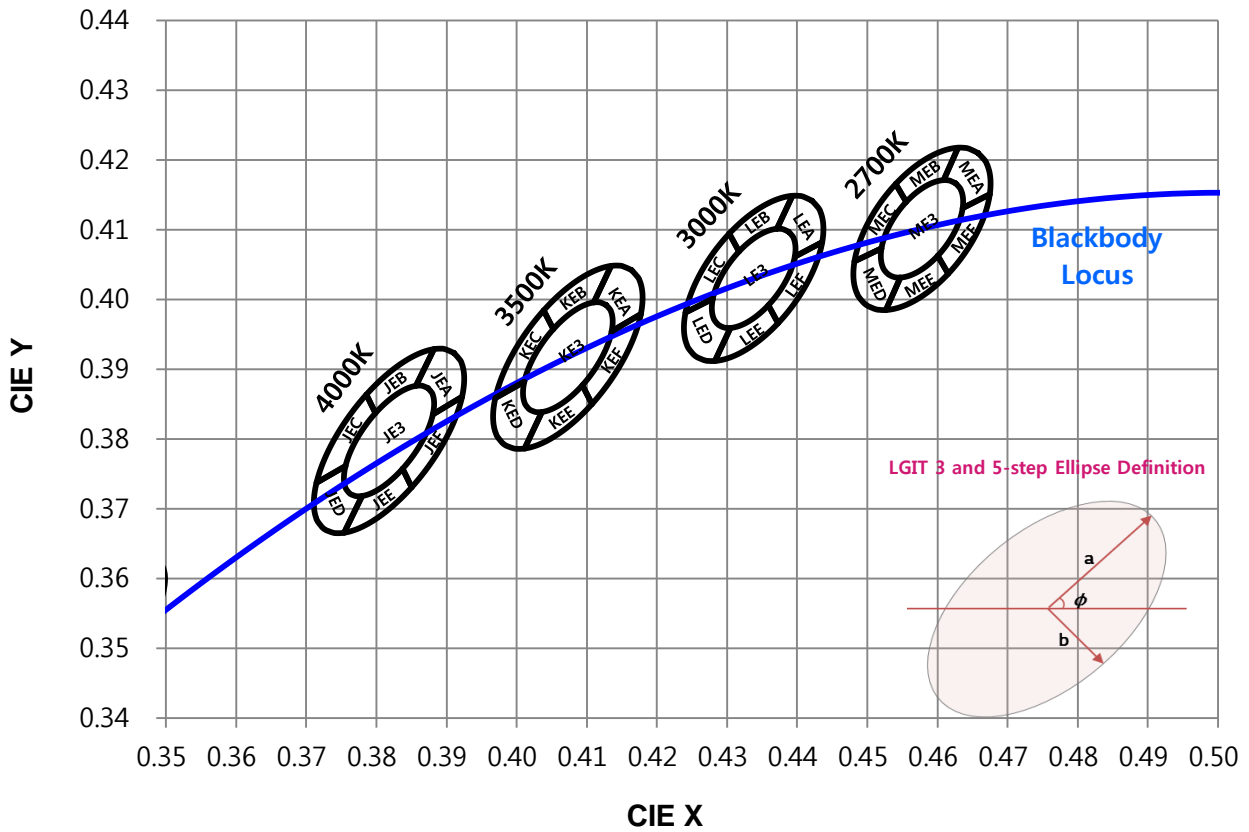

Nominal CCT (Rank)	Steps	Center Point		Major Axis	Minor Axis	Rotation Angle
		Cx	Cy	a	b	ϕ
2700K (ME3)	3	0.4578	0.4101	0.00810	0.00420	53.70
2700K (MEA-MEF)	5			0.01350	0.00700	
3000K (LE3)	3	0.4338	0.4030	0.00834	0.00408	53.22
3000K (LEA-LEF)	5			0.01390	0.00680	
3500K (KE3)	3	0.4073	0.3917	0.00927	0.00414	54.00
3500K (KEA-KEF)	5			0.01545	0.00690	
4000K (JE3)	3	0.3818	0.3797	0.00939	0.00402	53.72
4000K (JEA-JEF)	5			0.01565	0.00670	

8. Typical Characteristic Curves

- Forward Current vs. Forward Voltage

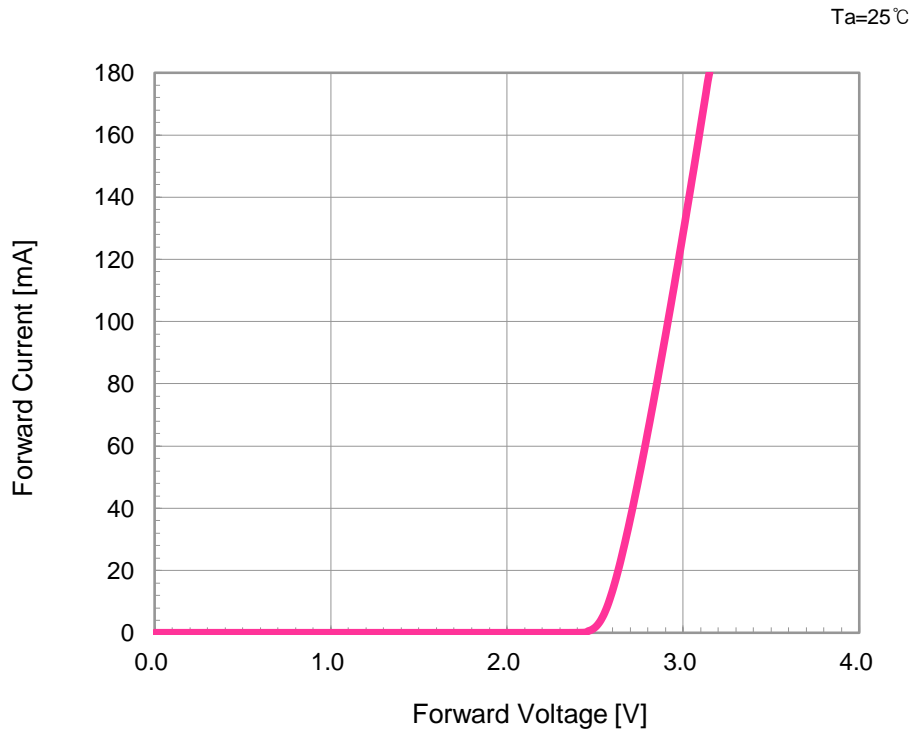

- Relative Luminous Flux vs. Forward Current

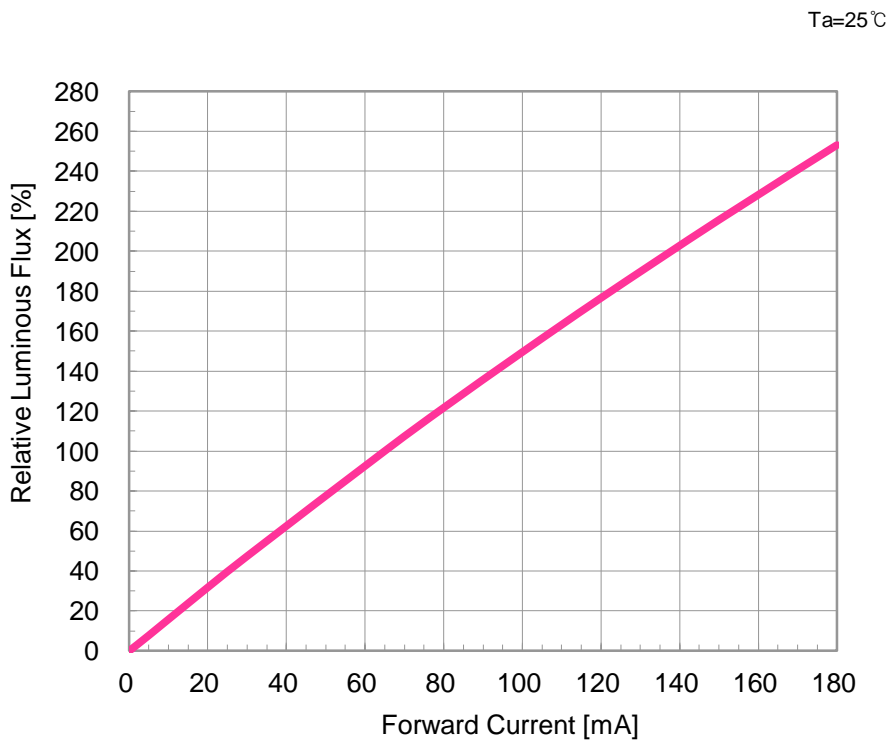

8. Typical Characteristic Curves

▪ Spectrum

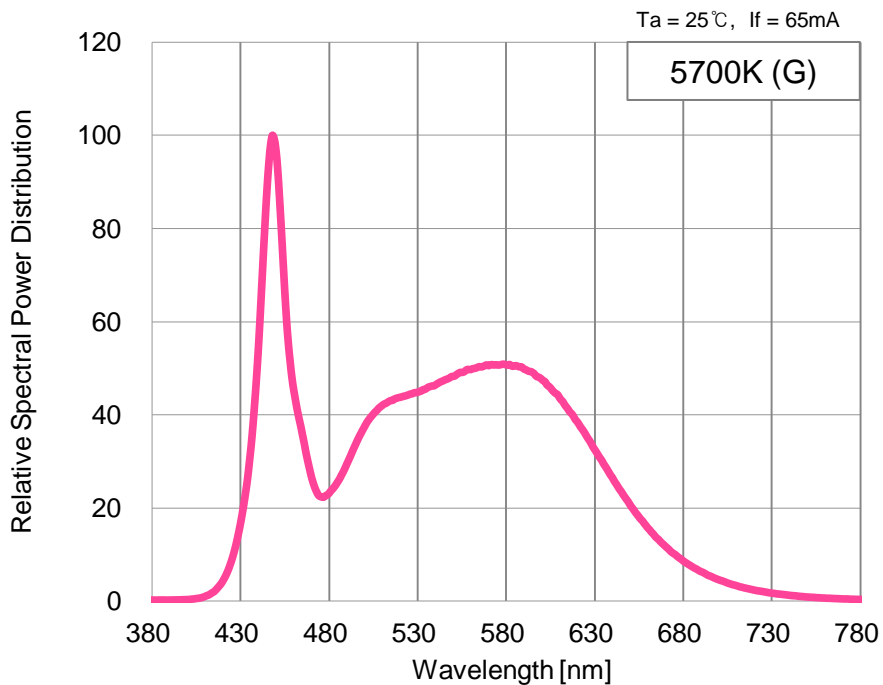
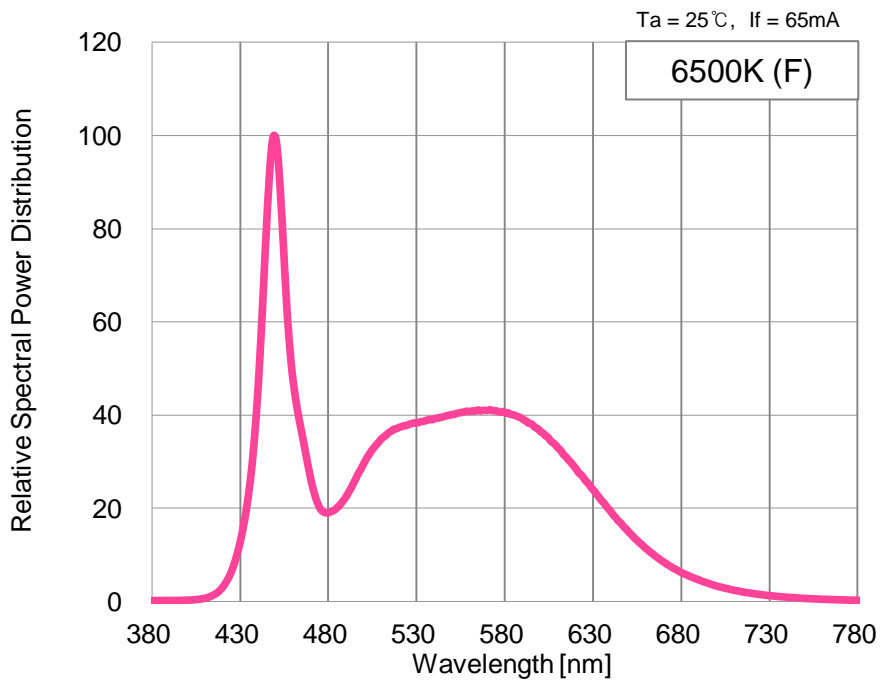

8. Typical Characteristic Curves

▪ Spectrum

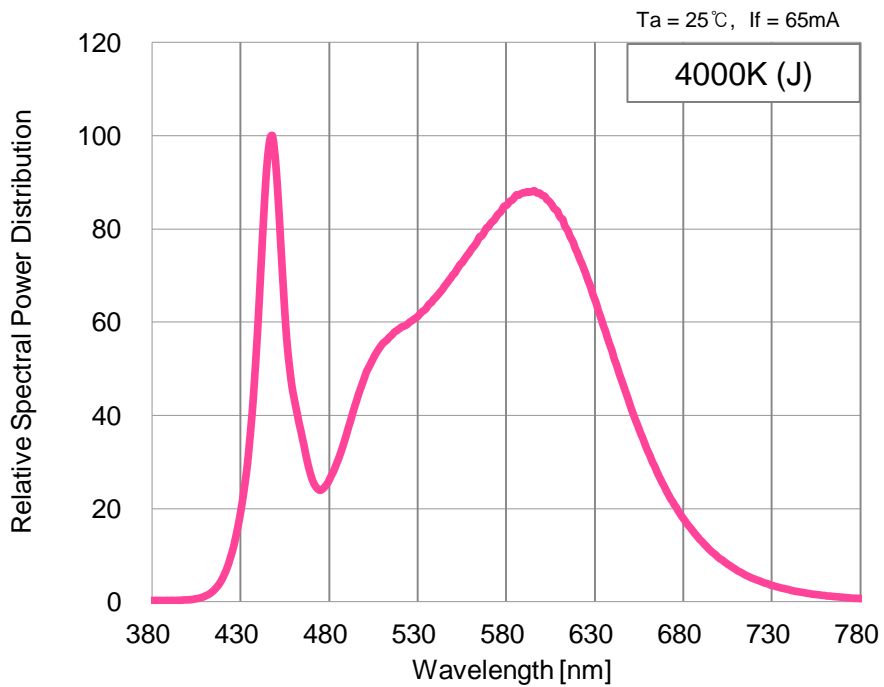
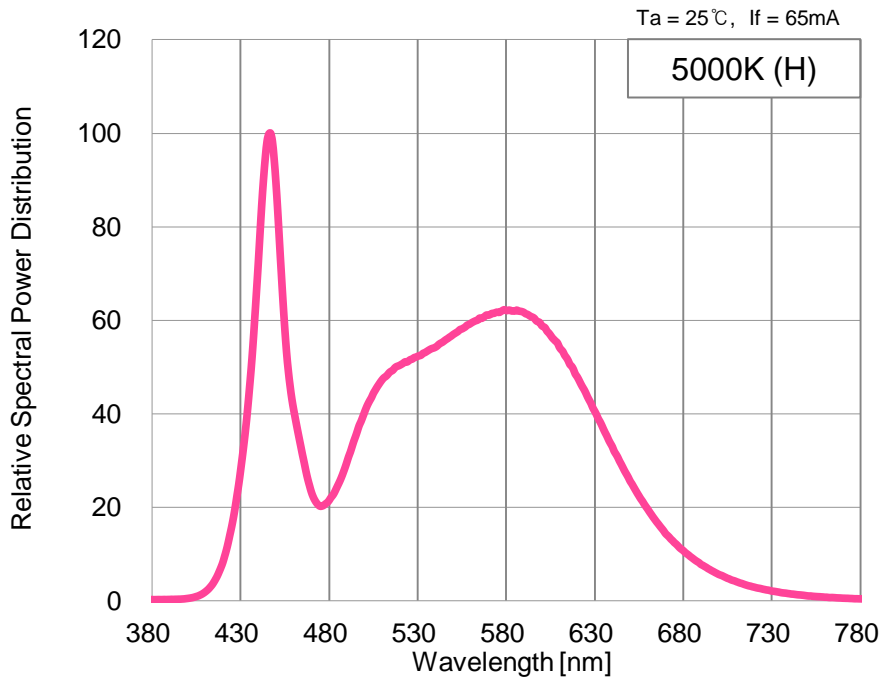

8. Typical Characteristic Curves

▪ Spectrum

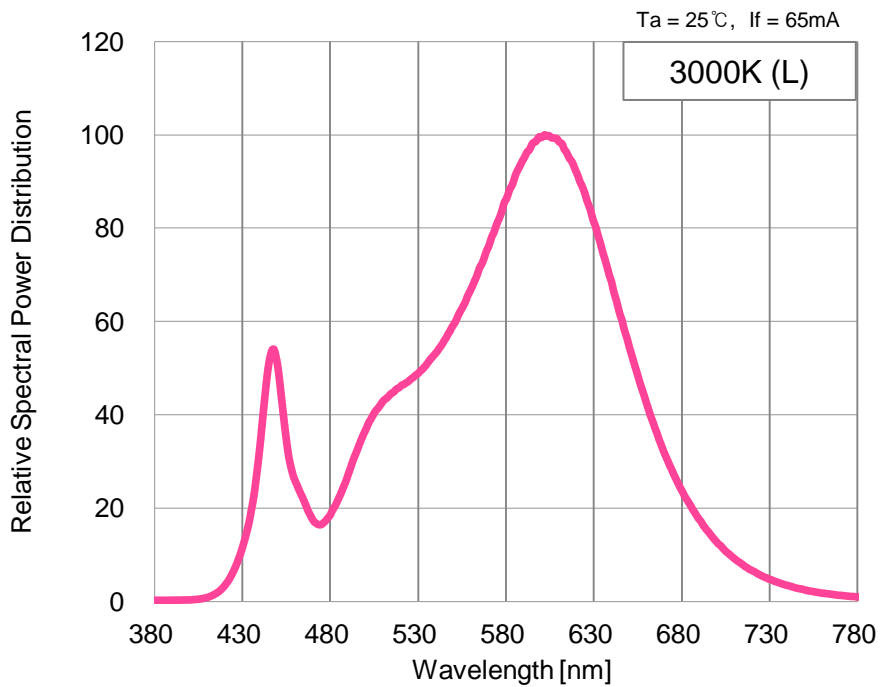
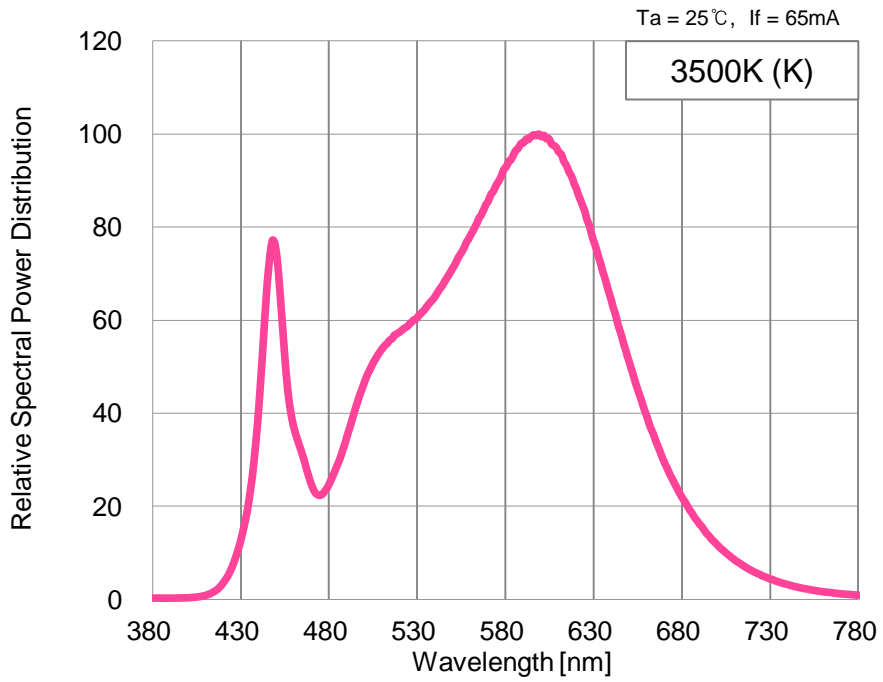

8. Typical Characteristic Curves

- Spectrum

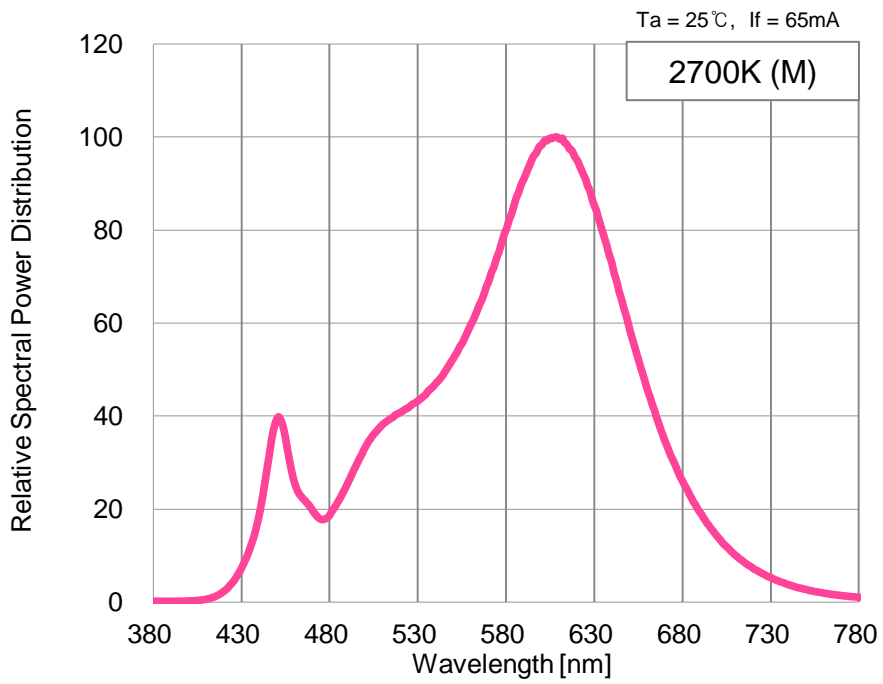

8. Typical Characteristic Curves

- Chromaticity Coordinate vs. Forward Current

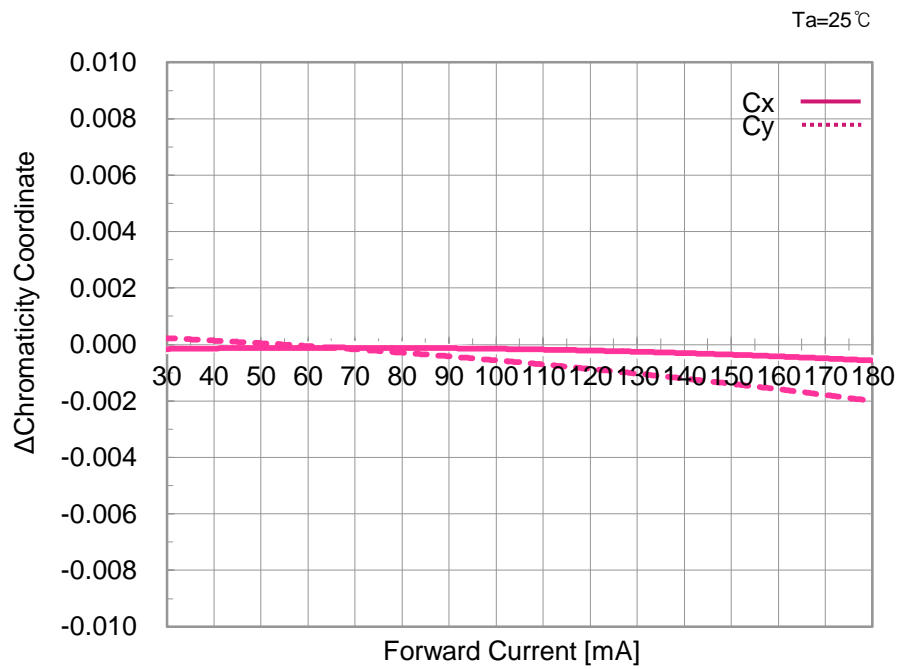

8. Typical Characteristic Curves

- Radiation Characteristics

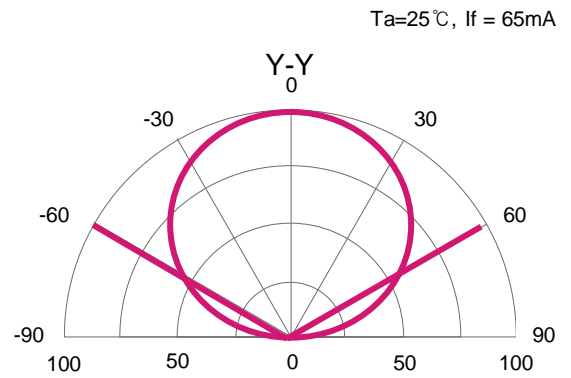
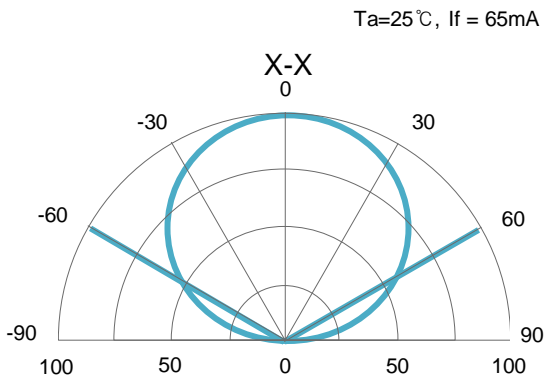

- Luminous Flux vs. Temperature

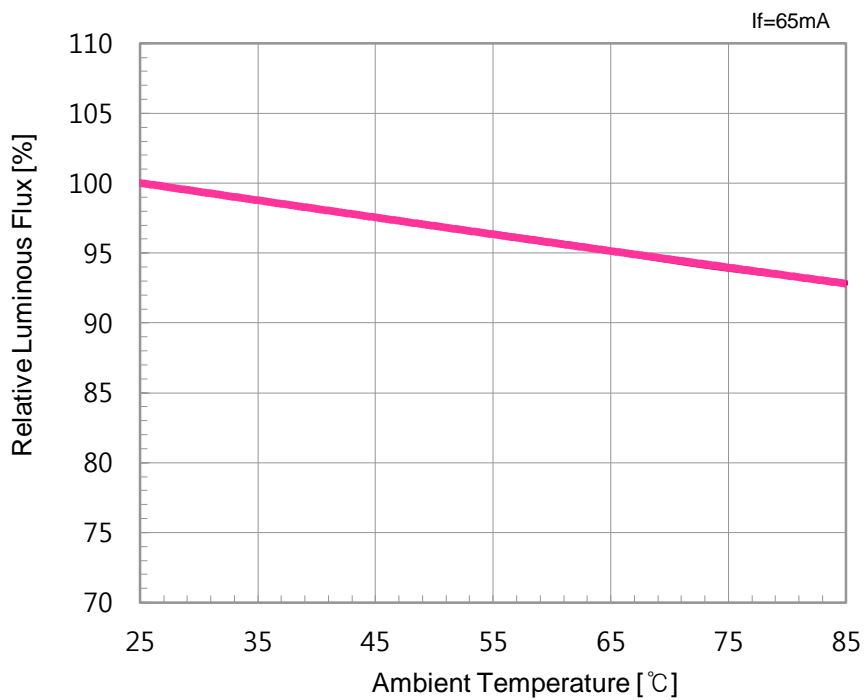

8. Typical Characteristic Curves

- Chromaticity Coordinate vs. Temperature

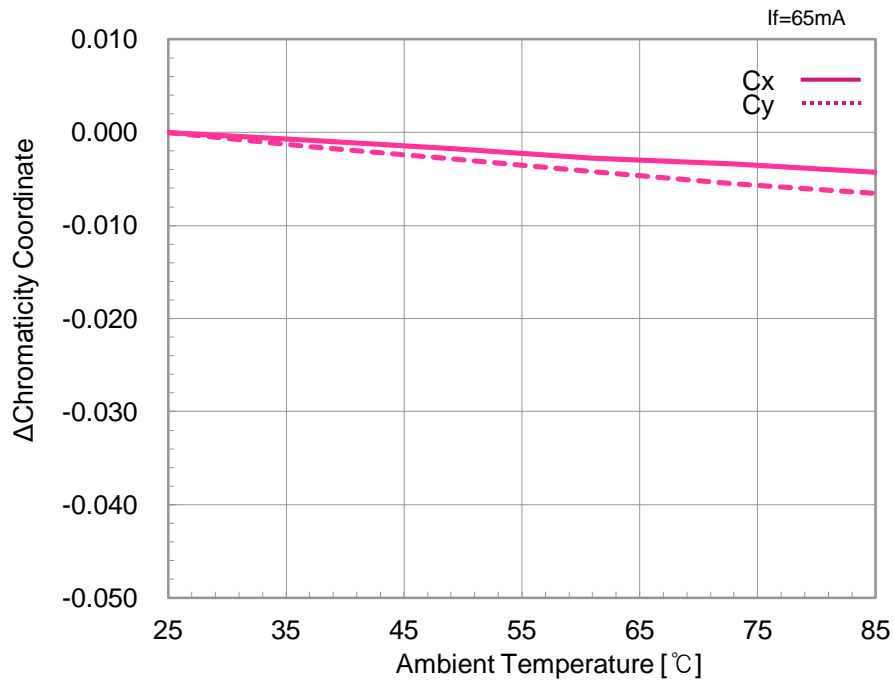

8. Typical Characteristic Curves

- Forward Voltage vs. Temperature

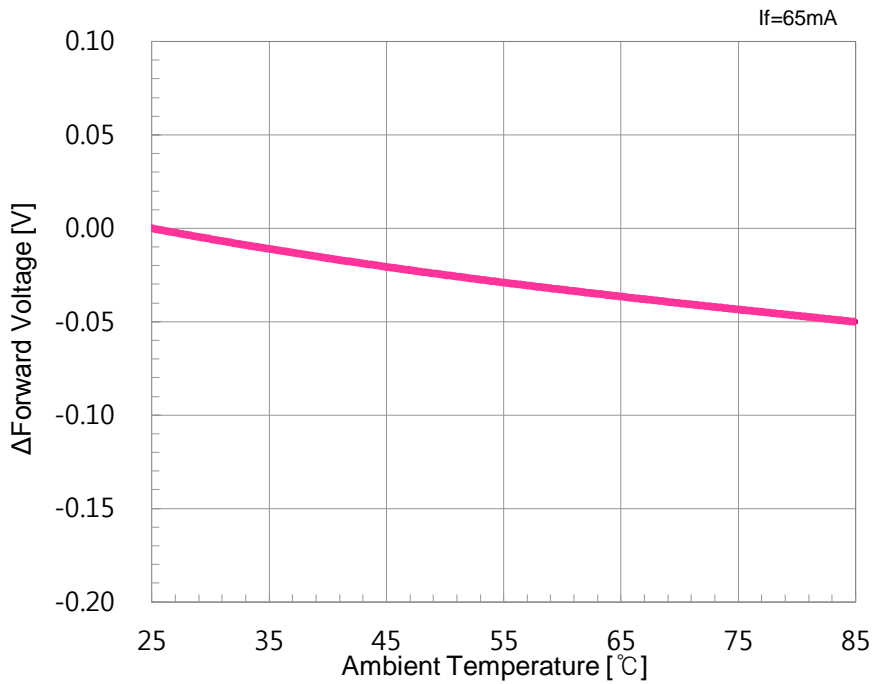

- Derating Curve

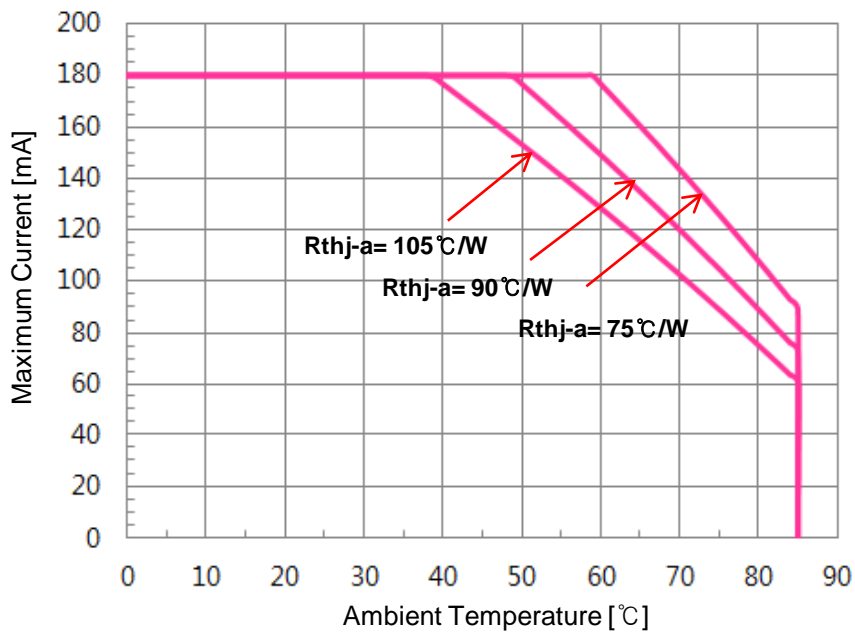

※ The ambient temperature values for each graph are obtained with LG Innotek equipment.

9. Reliability Test Items and Conditions

9-1. Failure Criteria

Items	Symbol	Test Conditions	Criteria	
			Min.	Max.
Forward Voltage	Vf	If = 65mA	-	Initial Value × 1.1
Luminous Flux	Φv	If = 65mA	Initial Value × 0.7	-

9-2. Reliability Tests

No	Items	Test Conditions	Test Hours /Cycles	Sample Size	Ac/Re
1	Room Temperature Operating Life (RTOL)	Ta = 25°C, If = 180mA	1,000 Hours	20 pcs	0/1
2	Wet High Temperature Operating Life (WHTOL)	Ta = 60°C, RH = 90% If = 180mA	1,000 Hours	20 pcs	0/1
3	High Temperature Operating Life (HTOL)	Ta = 85°C, If = 180mA	1,000 Hours	20 pcs	0/1
4	Low Temperature Operating Life (LTOL)	Ta = -40°C, If = 180mA	1,000 Hours	20 pcs	0/1
5	High Temperature Storage Life (HTSL)	Ta = 100°C	1,000 Hours	20 pcs	0/1
6	Low Temperature Storage Life (LTSL)	Ta = -40°C	1,000 Hours	20 pcs	0/1
7	Wet High Temperature Storage Life (WHTSL)	Ta = 85°C, RH = 85%	1,000 Hours	20 pcs	0/1
8	Temperature Cycle (TC)	-40°C (30min) ~ 100°C (30min)	100 Cycles	20 pcs	0/1
9	Moisture Sensitivity Level (MSL)	Tsld = 260°C (Pre treatment 60°C, 60% 168 hours)	3 Times	20 pcs	0/1
10	Vibration	100~2000~100Hz Sweep 4min. 200m/s ² , 3 directions	48 Minutes	20 pcs	0/1

※ All samples are tested using LG Innotek Standard Metal PCB (25x25x1.6 mm³(L×W×H)) except MSL test .

※ All samples must pass each test item and all test items must be satisfied.

10. Packing and Labeling of Products

10-1. Taping Outline Dimension

Reel

(Unit : mm)

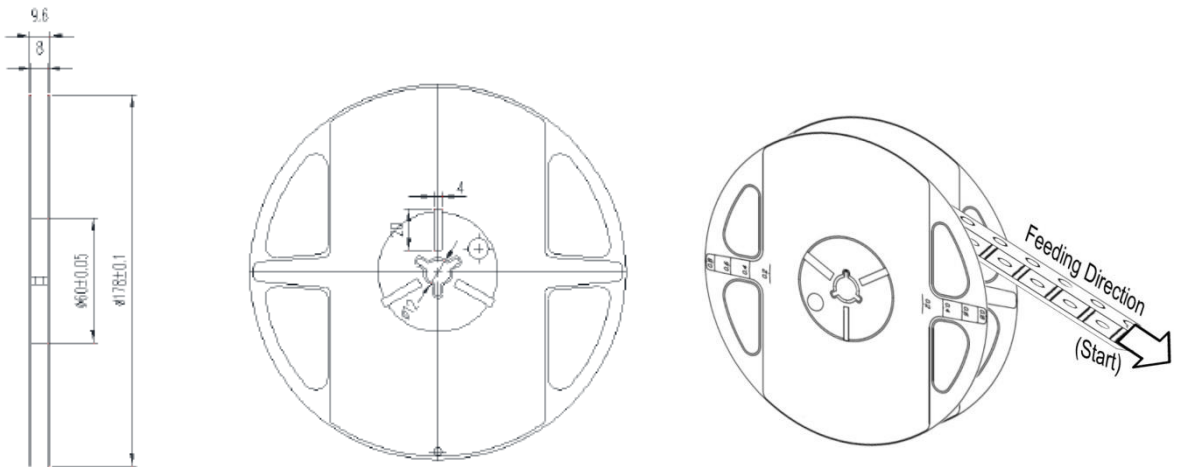

Tape

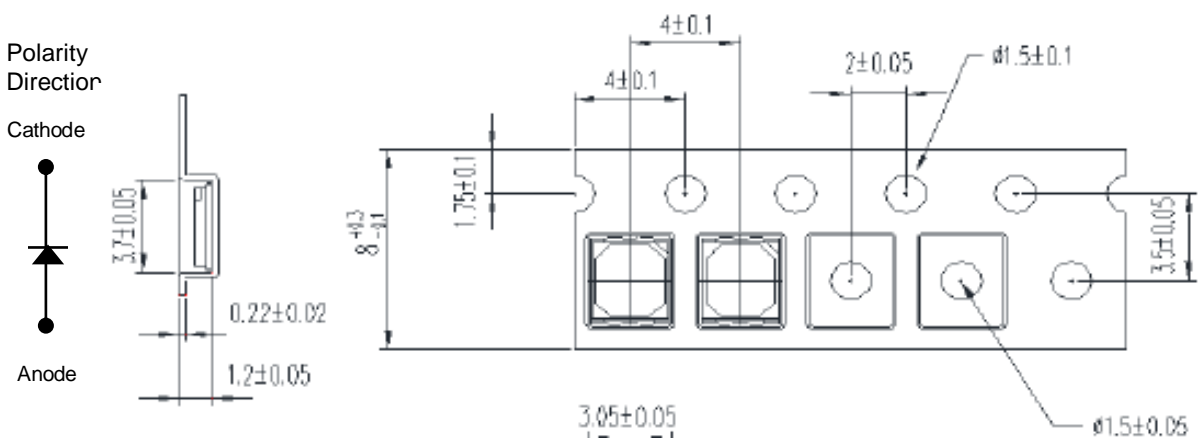

Taping Arrangement



10. Packing and Labeling of Products

10-2. Packing Structures

Reeled products are packed in a sealed-off and moisture-proof aluminum bag with desiccants (silica gel).

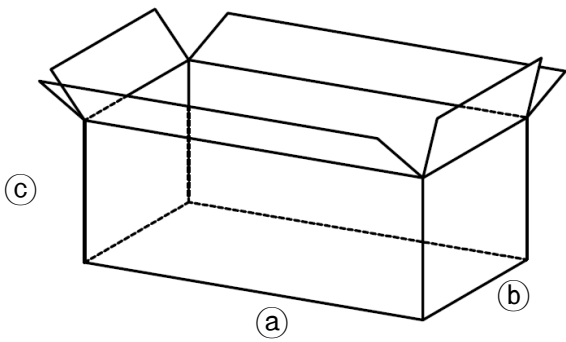
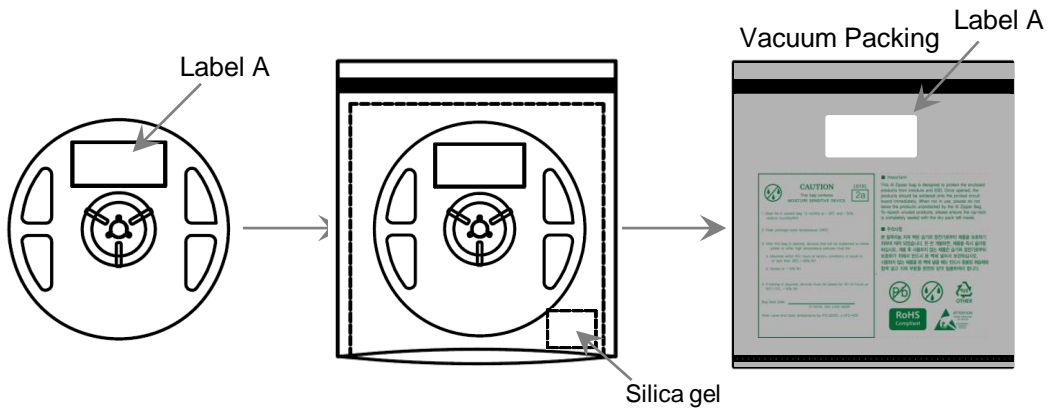

Types	Sizes (mm)		
	(a)	(b)	(c)
Outer Box	450	235	265

Tolerance : ±20mm

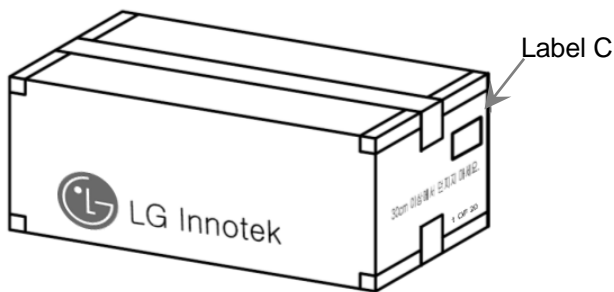

10. Packing and Labeling of Product

10-3. MES Label Structure

※ Label A

Specifying Model Name, Rank, Rack, Quantity and Run number

<Example>

40mm

80mm

▪ Run No. indication

1	2	3	4	5	6	—	7	8	9	10
Code	Manufactured Site	Manufactured Year	Manufactured Month	Manufactured Date			TH #	Serial No		
	Paju : 1 Huizhou : 9	2017 : 7 ... 2020 : 0 2021 : 1	1~9 : 1~9 10 : A 11 : B 12 : C	(01~31)			(00 ~ 99)	(00 ~ ZZ)		

※ Label C

Specifying Customer, Date, Model Name, Quantity, Customer Part no, Outbox ID, Rank/Rank Q'ty'

<Example>

40mm

80mm

▪ Box ID. indication

1	2	3	4	5	6	7	8	9	10
Manufactured Site	PKG Site	Box	Year	Month	Date		Serial No		
Paju : P Huizhou : H	PKG : S, P	Inner Box : I Outer Box : O	2017 : 7 ... 2020 : 0 2021 : 1	1~9 : 1~9 10 : A 11 : B 12 : C	(01 ~ 31)		(001 ~ 999)		

11. Cautions on Use

11-1. Moisture-Proof Package

- The moisture in the SMD package may vaporize and expand during soldering.
- The moisture can damage the optical characteristics of the LEDs due to the encapsulation.

11-2. During Storage

Conditions		Temperature	Humidity	Time
Storage	Before Opening Aluminum Bag	5°C ~ 30°C	< 50%RH	Within 1 Year from the Delivery Date
	After Opening Aluminum Bag	5°C ~ 30°C	< 60%RH	≤ 672 hours
Baking		65 ± 5°C	< 10%RH	10 ~ 24 hours

- The LEDs should be stored in a clean environment. If the LEDs are stored for 3 months or more after being shipped from LGIT, a sealed container with a nitrogen gas should be used for storage.
- When storing the LEDs after opening aluminum bag, reseal with a moisture absorbent material inside.

11-3. During Usage

- The LED should be avoided direct contact with hazardous materials such as sulfur, chlorine, phthalate, acid, solvent, etc. These materials(S, Cl, VOCs, etc.) may cause sulfurization of silver lead-frame or encapsulant silicone discoloration in LED.
VOCs(Volatile Organic Compounds) can be generated from adhesives glue, cleaning flux, molding hardener or organic additive which used in luminaires fixtures and they(VOCs) may cause a significant lumen degradation of LED in luminaires when they exposed to heat or light.
To prevent this phenomenon, materials used in luminaires must be carefully selected by users.
- The metal parts(Including silver plated metal) on the LED can rust when exposed to corrosive gases. Therefore, exposure to corrosive gases must be avoided during operation and storage.
- The metal parts(Including silver plated metal) also can be affected not only by the corrosive gases emitted inside of the end-products but by the gases penetrated from outside environment.
- Extreme environments such as sudden ambient temperature changes or high humidity that can cause condensation must be avoided.

11-4. Cleaning

- Do not use brushes for cleaning or organic solvents (i.e. Acetone, TCE, etc..) for washing as they may damage the resin of the LEDs.
- Isopropyl Alcohol(IPA) is the recommended solvent for cleaning the LEDs under the following conditions.
Cleaning Condition : IPA, 25°C max. × 60sec max.
- Ultrasonic cleaning is not recommended.
- Pretests should be conducted with the actual cleaning process to validate that the process will not damage the LEDs.

11. Cautions on Use

11-5. Thermal Management

- The thermal design of the end product must be seriously considered, particularly at the beginning of the system design process.
- The generation of heat is greatly impacted by the input power, the thermal resistance of the circuit boards and the density of the LED array combined with other components.

11-6. Static Electricity

- Wristbands and anti-electrostatic gloves are strongly recommended and all devices, equipment and machinery must be properly grounded when handling the LEDs, which are sensitive against static electricity and surge.
- Precautions are to be taken against surge voltage to the equipment that mounts the LEDs.
- Unusual characteristics such as significant increase of current leakage, decrease of turn-on voltage, or non-operation at a low current can occur when the LED is damaged.

11-7. Recommended Circuit

- The current through each LED must not exceed the absolute maximum rating when designing the circuits.
- In general, there can be various forward voltages for LEDs. Different forward voltages in parallel via a single resistor can result in different forward currents to each LED, which also can output different luminous flux values. In the worst case, the currents can exceed the absolute maximum ratings which can stress the LEDs. Matrix circuit with a single resistor for each LED is recommended to avoid the luminous flux fluctuations.

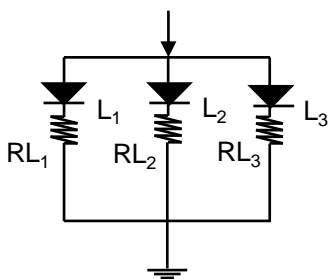

Fig.1 Recommended Circuit in Parallel Mode
: Separate resistors must be used for each LED.

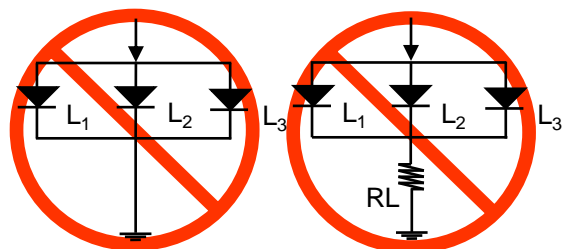

Fig.2 Abnormal Circuit
Circuits to Avoid : The current through the LEDs may vary due to the variation in LED forward voltage.

- The driving circuits must be designed to operate the LEDs by forward bias only.
- Reverse voltages can damage the zener diode, which can cause the LED to fail.
- A constant current LED driver is recommended to power the LEDs.

11. Cautions on Use

11-8. Soldering Conditions

- Reflow soldering is the recommended method for assembling LEDs on a circuit board.
- LG Innotek does not guarantee the performance of the LEDs assembled by the dip soldering method.
- Recommended Soldering Profile (according to JEDEC J-STD-020D)

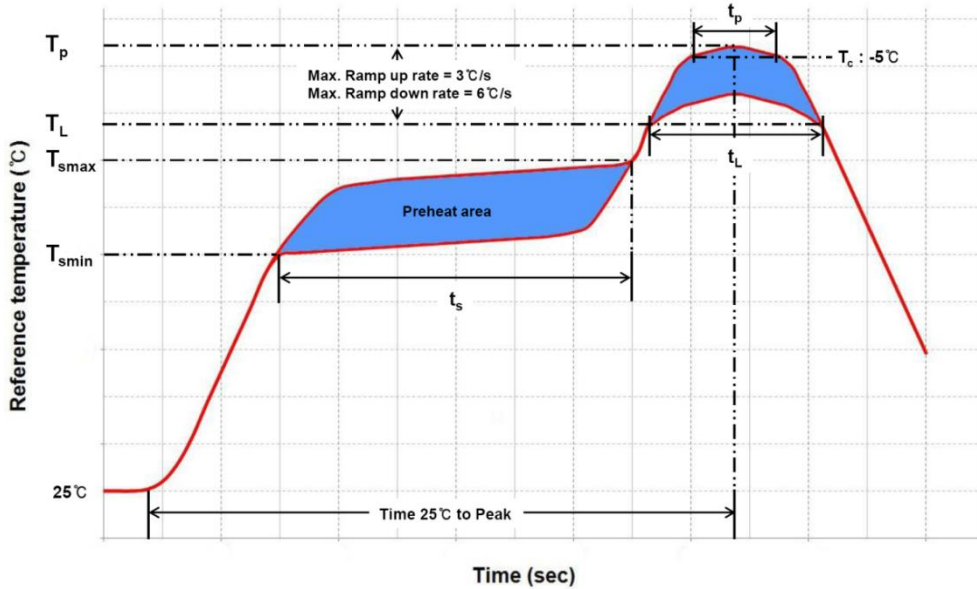

Profile Feature	Pb-Free Assembly	Pb-Based Assembly
Preheat / Soak		
Temperature Min (T_{smin})	150 °C	100 °C
Temperature Max (T_{smax})	200 °C	150 °C
Maximum time(t_s) from T_{smin} to T_{smax}	60~120 seconds	60~120 seconds
Ramp-up rate (T_L to T_p)	3°C/ second max.	3°C/ second max.
Liquidus temperature (T_L)	217 °C	183 °C
Time (t_L) maintained above T_L	60~150 seconds	60~150 seconds
Maximum peak package body temperature (T_p)	260 °C	235 °C
Time(t_p) within 5°C of the specified temperature (T_c)	30 seconds	20 seconds
Ramp-down rate (T_p to T_L)	6°C/second max.	6°C/second max.
Maximum Time 25°C to peak temperature	8 minutes max.	6 minutes max.

- Reflow or hand soldering at the lowest possible temperature is desirable for the LEDs although the recommended soldering conditions are specified in the above diagrams.
- A rapid cooling process is not recommended for the LEDs from the peak temperature.
- The silicone encapsulant at the top of the LED package is a soft surface, which can easily be damaged by pressure. Precautions should be taken to avoid strong pressure on the silicone resin when leveraging the pick and place machines.
- Reflow soldering should not be done more than two times.

11. Cautions on Use

11-9. Soldering Iron

- The recommended condition is less than 5 seconds at 260°C.
- The time must be shorter for higher temperatures. (+10°C → -1sec).
- The power dissipation of the soldering iron should be lower than 15W and the surface temperature of the device should be controlled at or under 230°C.

11-10. Eye Safety Guidelines

- Do not directly look at the light when the LEDs are on.
- Proceed with caution to avoid the risk of damage to the eyes when examining the LEDs with optical instruments.

11-11. Manual Handling

- Use Teflon-type tweezers to grab the base of the LED and do not apply mechanical pressure on the surface of the encapsulant.

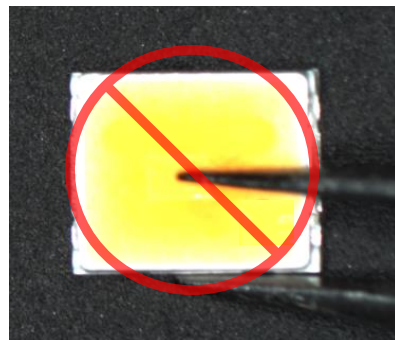
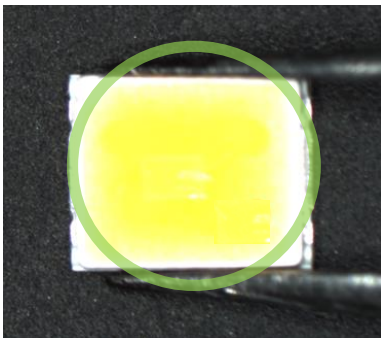

12. Disclaimers

- LG Innotek is not responsible for any damages or accidents caused if the operating or storage conditions exceed the absolute maximum ratings recommended in this document.
- The LEDs described in this document are intended to be operated by ordinary electronic equipment.
- The LEDs should not be used at any lighting products together with the other LEDs, which has a different part number. If required, please contact any sales person.
- It is recommended to consult with LG Innotek when the environment or the LED operation is non-standard in order to avoid any possible malfunctions or damage to product or risk of life or health.
- Disassembly of the LED products for the purpose of reverse engineering is prohibited without prior written consent from LG Innotek. All defected LEDs must be reported to LG Innotek and are not to be disassembled or analyzed.
- The product information can be modified and upgraded without prior notice.