



**ProLight PBLB-3LTE-RGBV**  
**3-4W 4 in 1 RGBV Power LED**  
**Technical Datasheet**  
**Version: 1.6**

# ProLight Opto ® ProEngine Series

## Features

- Compact light source
- R, G, B, V four color in one package
- Maximum drive current: 300mA per LED die
- Lead free reflow soldering
- RoHS compliant

## Main Applications

- Entertainment lighting (Stage lighting)
- Architectural lighting
- Mood lighting
- Outdoor lighting
- Indoor lighting

## Introduction

- ProLight PBLB colorful series is a color changeable LED with maximum 4 color chips in one package. Compared to discrete LEDs, PBLB series reduce the distance between LED die, creating a small optical source for excellent optical control and efficient color mixing. ProLight PBLB series is much suitable for the application of color-changing lighting, especially for entertainment lighting.

## Emitter Mechanical Dimensions

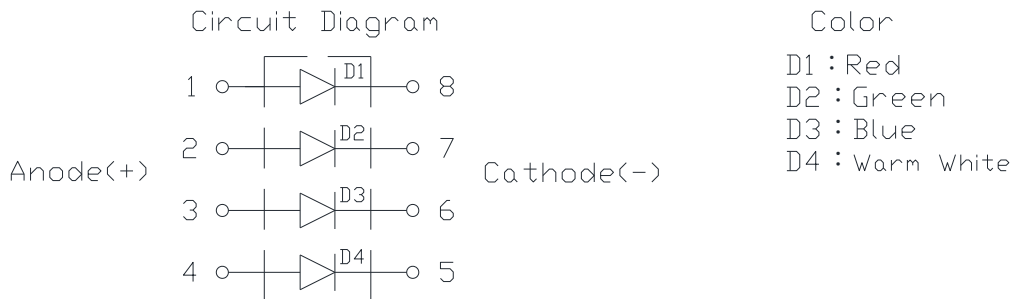
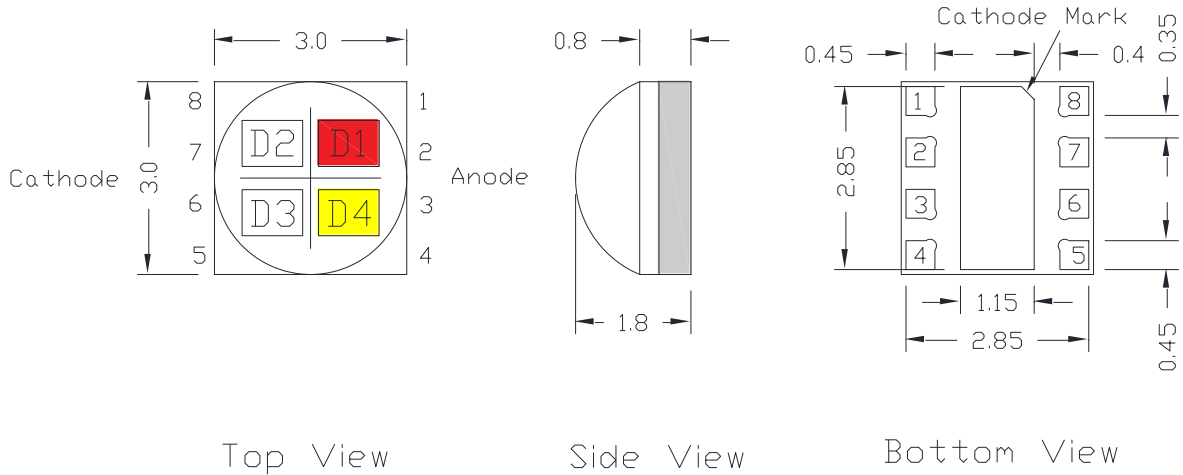

### Notes:

1. Drawing not to scale.
2. All dimensions are in millimeters.
3. Unless otherwise indicated, tolerances are  $\pm 0.15\text{mm}$ .
4. Please do not solder the emitter by manual hand soldering, otherwise it will damage the emitter.
5. **Please do not use a force of over 1kgf impact or pressure on the lens of the LED, otherwise it will cause a catastrophic failure.**

\*The appearance and specifications of the product may be modified for improvement without notice.

## Flux Characteristics at 250mA, T<sub>j</sub> = 25°C

Color	Part Number Emitter	Luminous Flux Φ <sub>v</sub> (lm)		CRI Minimum
		Minimum	Typical	
Red	PBLB-3LTE-RGBV	30	36	-
Green		40	52	-
Blue		8	11	-
Warm White		34.1	46	80

- ProLight maintains a tolerance of ± 7% on flux and power measurements.
- Please do not drive at rated current more than 1 second without proper heat sink.

## Electrical Characteristics at 250mA, T<sub>j</sub> = 25°C

Color	Forward Voltage V <sub>F</sub> (V)			Thermal Resistance Junction to Slug (°C/ W)
	Min.	Typ.	Max.	
Red	1.9	2.3	2.7	10
Green	3.0	3.5	4.0	
Blue	2.9	3.4	3.9	
Warm White	2.9	3.4	3.9	

- ProLight maintains a tolerance of ± 0.1V for Voltage measurements.

## Optical Characteristics at 250mA, T<sub>j</sub> = 25°C

Radiation Pattern	Color	Dominant Wavelength λ <sub>D</sub> , or Color Temperature CCT			Total included Angle (degrees) θ <sub>0.90V</sub>	Viewing Angle (degrees) 2 θ <sub>1/2</sub>
		Min.	Typ.	Max.		
		Lambertian	Red	620 nm		
Green	518 nm		522 nm	528 nm		
Blue	453 nm		457 nm	460 nm		
Warm White	2870 K		3000 K	3220 K		

- ProLight maintains a tolerance of ± 1nm for dominant wavelength measurements.
- ProLight maintains a tolerance of ± 5% for CCT measurements.

## Absolute Maximum Ratings

Parameter	Red/Green/Blue/Warm White
DC Forward Current (mA)	300
Peak Pulsed Forward Current (mA)	330 (less than 1/10 duty cycle@1KHz)
ESD Sensitivity (HBM per MIL-STD-883E Method 3015.7)	> ±500V
LED Junction Temperature	120°C
Operating Board Temperature at Maximum DC Forward Current	-40°C - 85°C
Storage Temperature	-40°C - 120°C
Soldering Temperature	JEDEC 020c 260°C
Allowable Reflow Cycles	3
Reverse Voltage	Not designed to be driven in reverse bias

## Photometric Luminous Flux Bin Structure

Color	Bin Code	Minimum Photometric Flux (lm)	Maximum Photometric Flux (lm)
Red	A	30	37
	B	37	46
Green	A	40	52
	B	52	66
Blue	A	8	10.4
	B	10.4	13.6
Warm White	A	34.1	42.9
	B	42.9	53.9

- ProLight maintains a tolerance of ± 7% on flux and power measurements.
- The flux bin of the product may be modified for improvement without notice.

## Color Bin

### Warm White Binning Structure Graphical Representation

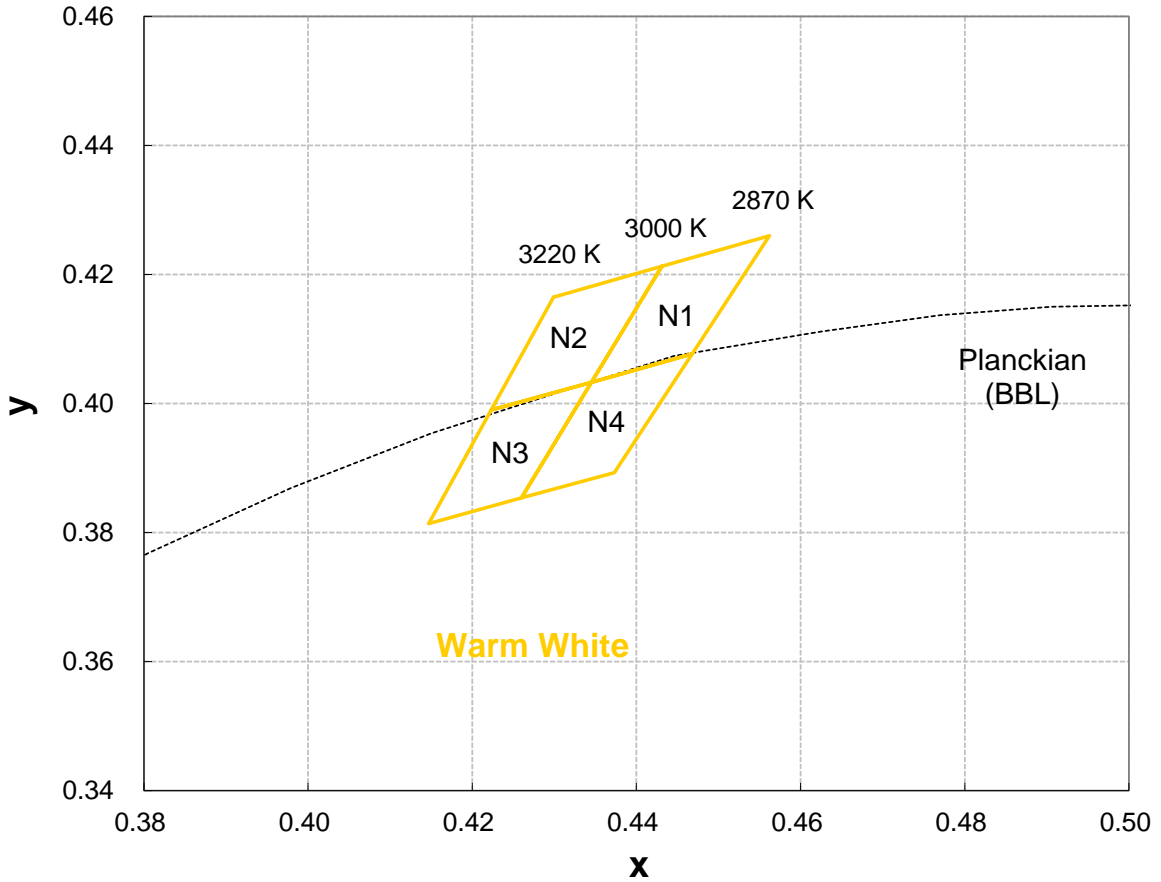

### Warm White Bin Structure

Bin Code	x	y	Typ. CCT (K)	Bin Code	x	y	Typ. CCT (K)
N1	0.4431	0.4213	2950	N2	0.4299	0.4165	3100
	0.4562	0.4260			0.4431	0.4213	
	0.4468	0.4077			0.4345	0.4033	
	0.4345	0.4033			0.4223	0.3990	
N4	0.4345	0.4033	2950	N3	0.4223	0.3990	3100
	0.4468	0.4077			0.4345	0.4033	
	0.4373	0.3893			0.4260	0.3854	
	0.4260	0.3854			0.4147	0.3814	

- Tolerance on each color bin (x , y) is  $\pm 0.005$

## Dominant Wavelength Bin Structure

Color	Bin Code	Minimum Dominant Wavelength (nm)	Maximum Dominant Wavelength (nm)
Red	4	620	630
Green	1	518	528
Blue	A	453	460

- ProLight maintains a tolerance of  $\pm 1$ nm for dominant wavelength measurements.

Note: Although several bins are outlined, product availability in a particular bin varies by production run and by product performance. Not all bins are available in all colors.

## Forward Voltage Bin Structure

Color	Bin Code	Minimum Voltage (V)	Maximum Voltage (V)
Red	0	1.9	2.7
Green	0	3.0	4.0
Blue	0	2.9	3.9
Warm White	0	2.9	3.9

- ProLight maintains a tolerance of  $\pm 0.1$ V for Voltage measurements.

Note: Although several bins are outlined, product availability in a particular bin varies by production run and by product performance. Not all bins are available in all colors.

## Color Spectrum, $T_j = 25^\circ\text{C}$

### 1. Blue \ Green \ Red

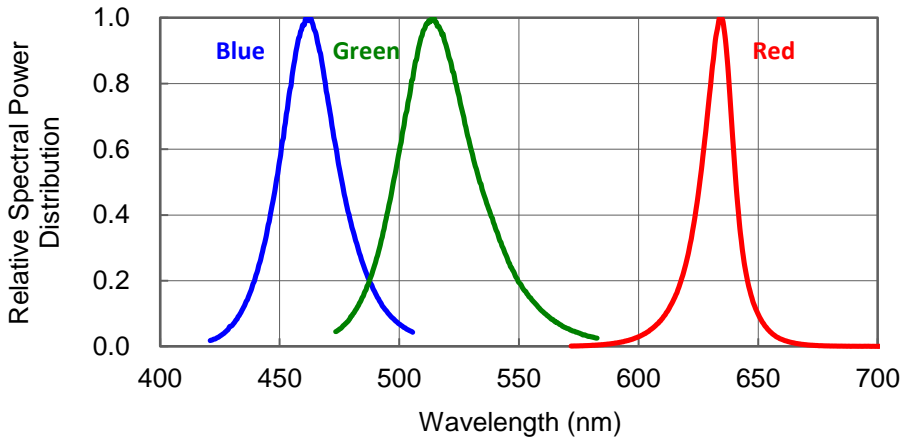

### 2. Warm White

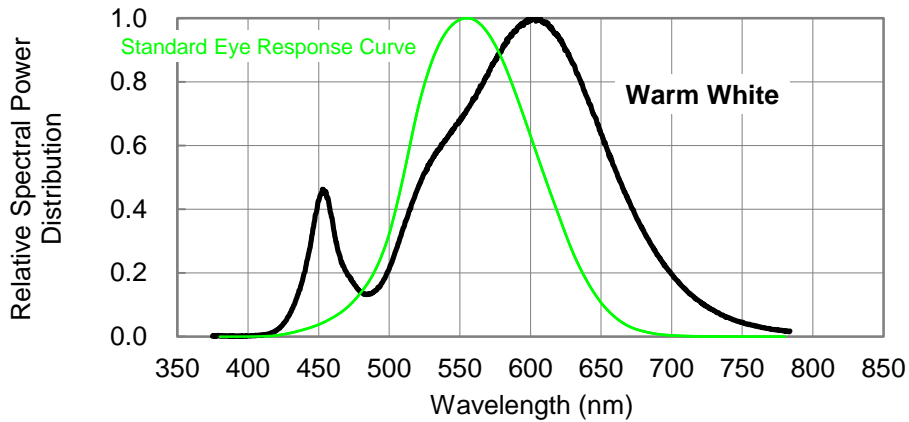

# Light Output Characteristics

Relative Light Output vs. Junction Temperature at 300mA

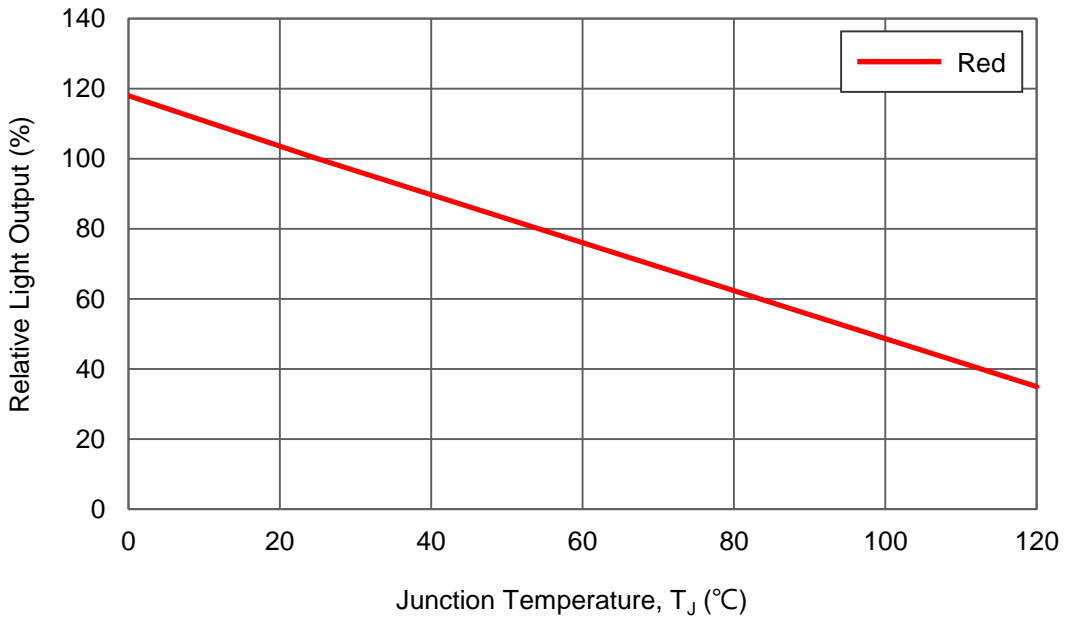
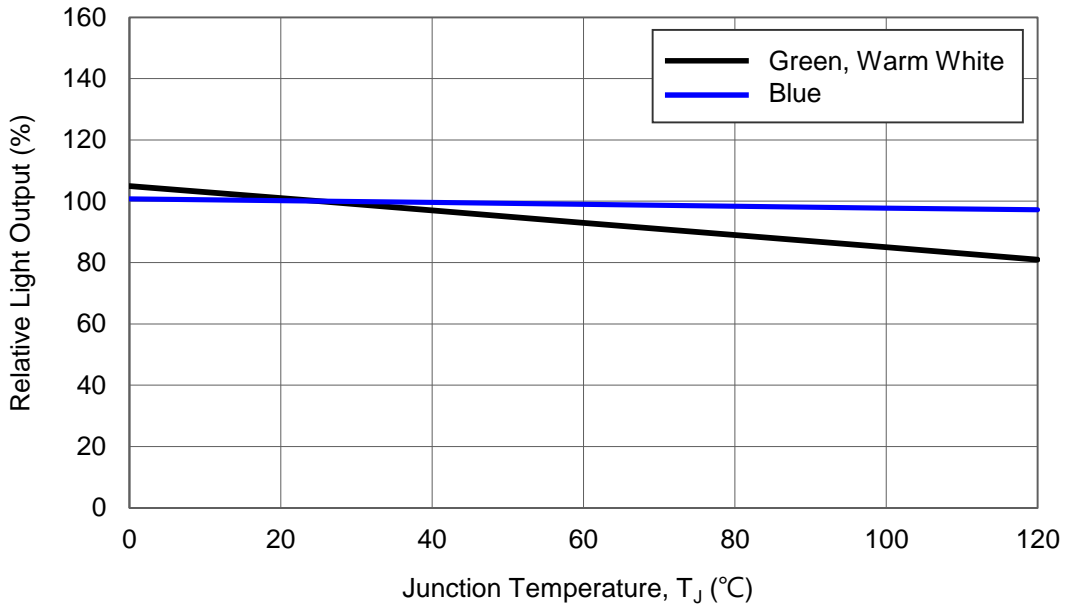



# Forward Current Characteristics, $T_j = 25^\circ\text{C}$

## 1. Forward Voltage vs. Forward Current

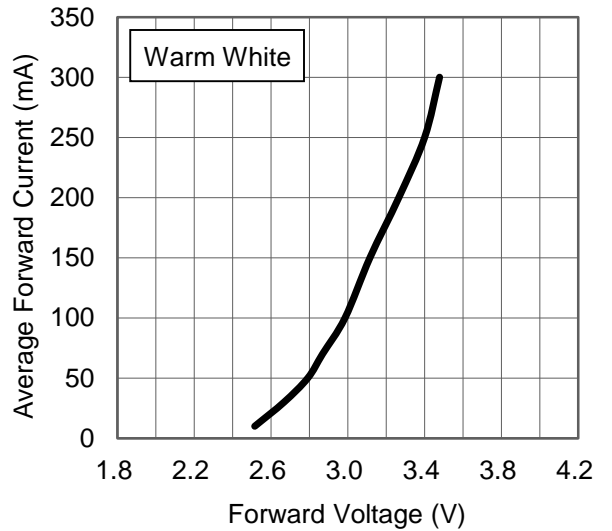
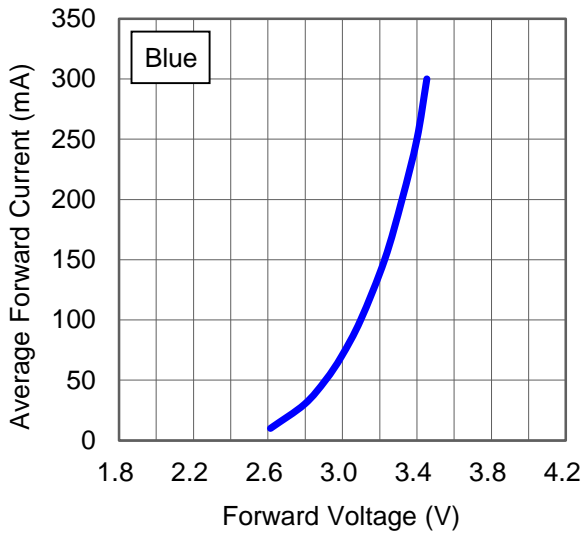
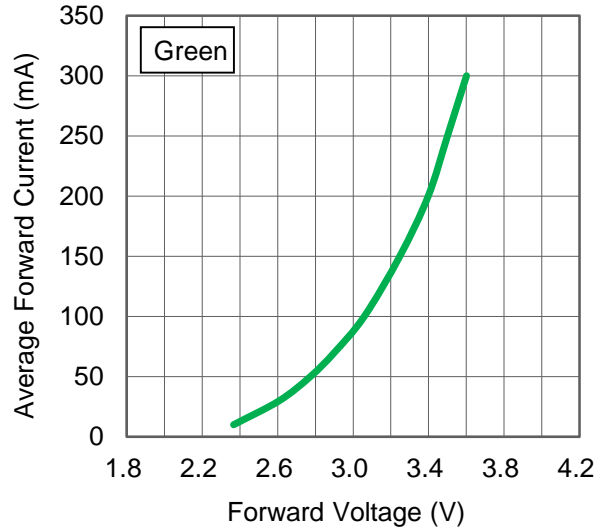
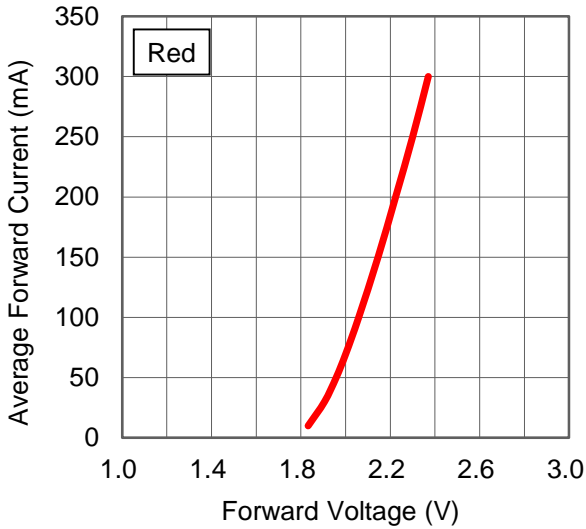

## Forward Current Characteristics, $T_j = 25^\circ\text{C}$

### 2. Forward Current vs. Normalized Relative Luminous Flux

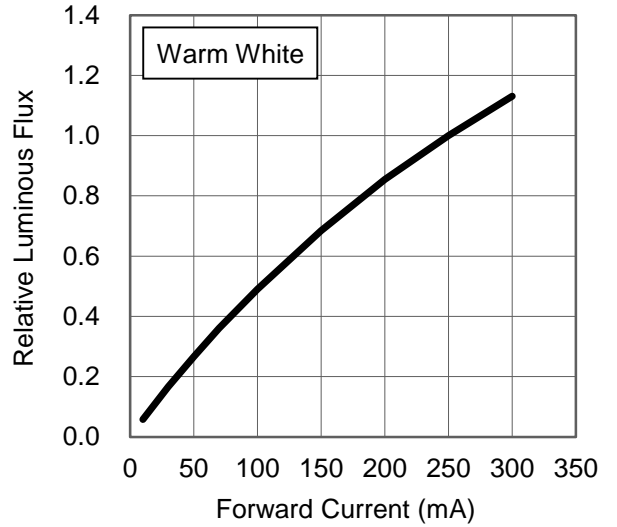
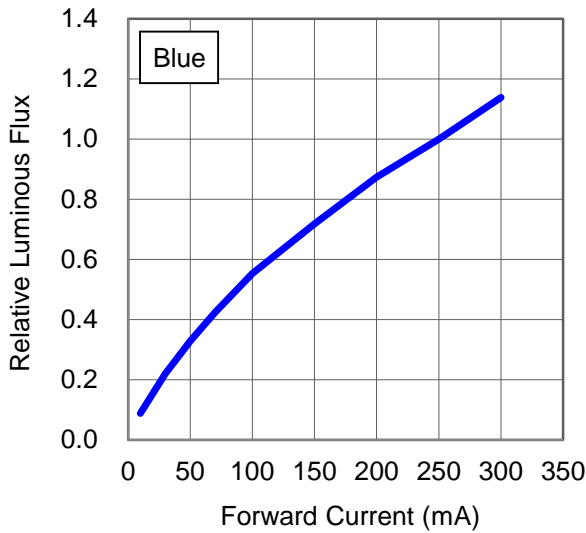
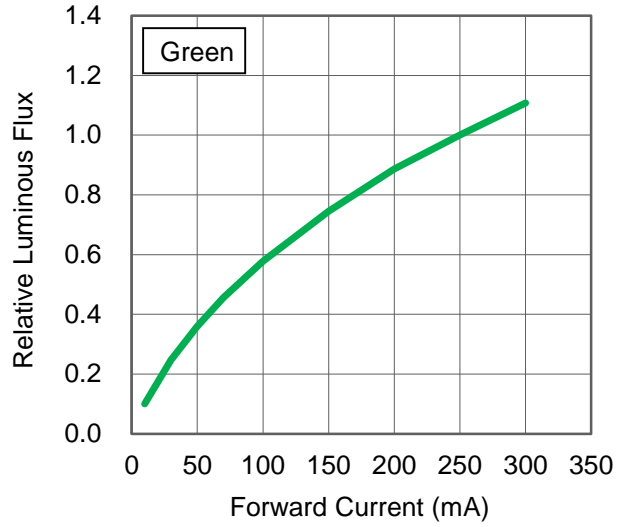
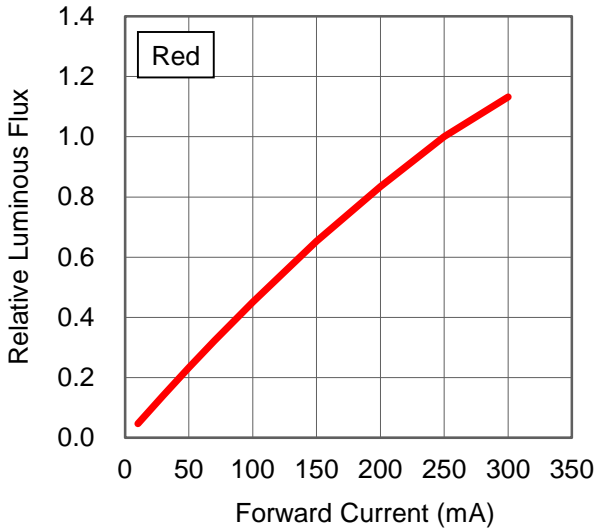

## Board Temperature vs. Maximum Forward Current

Maximum Forward Current for 4 chip operated

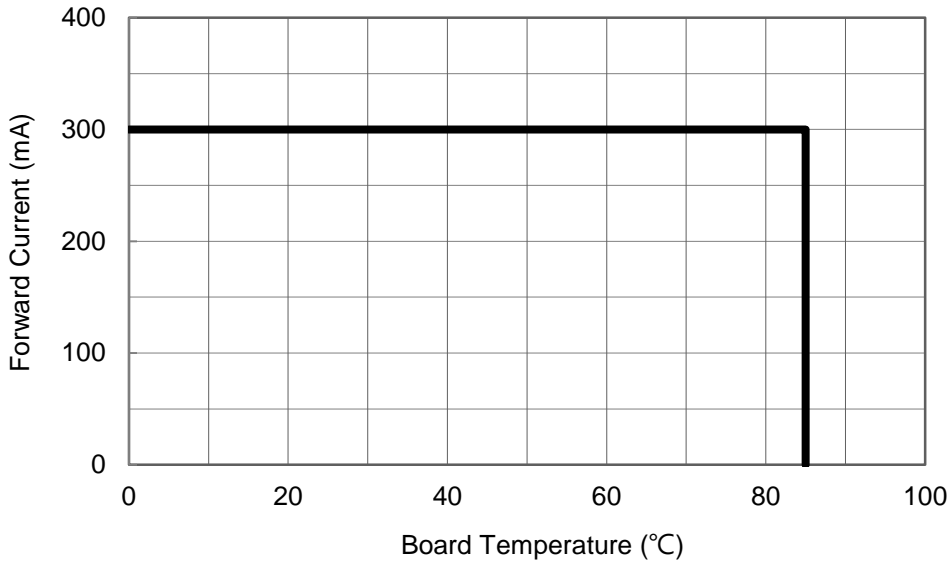

## Typical Representative Spatial Radiation Pattern

Lambertian Radiation Pattern

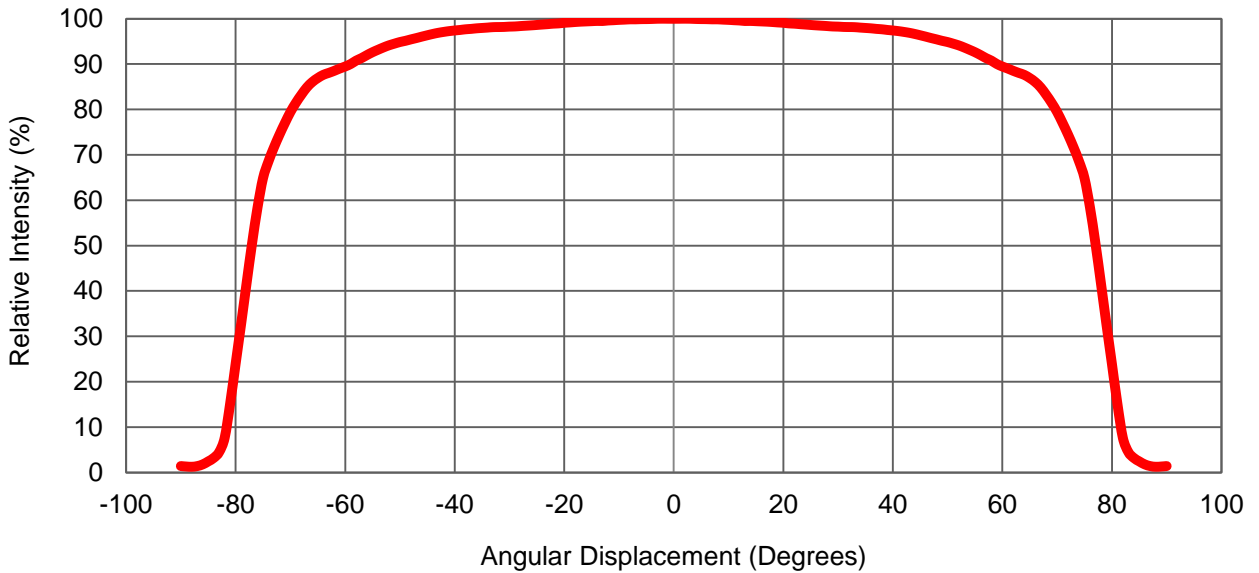

## Moisture Sensitivity Level – JEDEC Level 1

Level	Floor Life		Soak Requirements			
			Standard		Accelerated Environment	
	Time	Conditions	Time (hours)	Conditions	Time (hours)	Conditions
1	Unlimited	≤30°C / 85% RH	168 +5/-0	85°C / 85% RH	NA	NA

- The standard soak time includes a default value of 24 hours for semiconductor manufacture's exposure time (MET) between bake and bag and includes the maximum time allowed out of the bag at the distributor's facility.
- Table below presents the moisture sensitivity level definitions per IPC/JEDEC's J-STD-020C.

Level	Floor Life		Soak Requirements			
			Standard		Accelerated Environment	
	Time	Conditions	Time (hours)	Conditions	Time (hours)	Conditions
1	Unlimited	≤30°C / 85% RH	168 +5/-0	85°C / 85% RH	NA	NA
2	1 year	≤30°C / 60% RH	168 +5/-0	85°C / 60% RH	NA	NA
2a	4 weeks	≤30°C / 60% RH	696 +5/-0	30°C / 60% RH	120 +1/-0	60°C / 60% RH
3	168 hours	≤30°C / 60% RH	192 +5/-0	30°C / 60% RH	40 +1/-0	60°C / 60% RH
4	72 hours	≤30°C / 60% RH	96 +2/-0	30°C / 60% RH	20 +0.5/-0	60°C / 60% RH
5	48 hours	≤30°C / 60% RH	72 +2/-0	30°C / 60% RH	15 +0.5/-0	60°C / 60% RH
5a	24 hours	≤30°C / 60% RH	48 +2/-0	30°C / 60% RH	10 +0.5/-0	60°C / 60% RH
6	Time on Label (TOL)	≤30°C / 60% RH	Time on Label (TOL)	30°C / 60% RH	NA	NA

## Qualification Reliability Testing

Stress Test	Stress Conditions	Stress Duration	Failure Criteria
Room Temperature Operating Life (RTOL)	25°C, $I_F = \text{max DC}$ (Note 1)	1000 hours	Note 2
Wet High Temperature Storage Life (WHTSL)	85°C/85%RH, non-operating	1000 hours	Note 2
High Temperature Storage Life (HTSL)	110°C, non-operating	1000 hours	Note 2
Low Temperature Storage Life (LTSL)	-40°C, non-operating	1000 hours	Note 2
Non-operating Temperature Cycle (TMCL)	-40°C to 120°C, 30 min. dwell, <5 min. transfer	200 cycles	Note 2
Mechanical Shock	1500 G, 0.5 msec. pulse, 5 shocks each 6 axis		Note 3
Natural Drop	On concrete from 1.2 m, 3X		Note 3
Variable Vibration Frequency	10-2000-10 Hz, log or linear sweep rate, 20 G about 1 min., 1.5 mm, 3X/axis		Note 3
Solder Heat Resistance (SHR)	260°C ± 5°C, 10 sec.		Note 3
Solderability	Steam age for 16 hrs., then solder dip at 260°C for 5 sec.		Solder coverage on lead

Notes:

1. Depending on the maximum derating curve.
2. Criteria for judging failure

Item	Test Condition	Criteria for Judgement	
		Min.	Max.
Forward Voltage ( $V_F$ )	$I_F = \text{max DC}$	--	Initial Level x 1.1
Luminous Flux or Radiometric Power ( $\Phi_V$ )	$I_F = \text{max DC}$	Initial Level x 0.7	--
Reverse Current ( $I_R$ )	$V_R = 5V$	--	50 $\mu A$

\* The test is performed after the LED is cooled down to the room temperature.

3. A failure is an LED that is open or shorted.

## Recommended Solder Pad Design

### Solder Pad

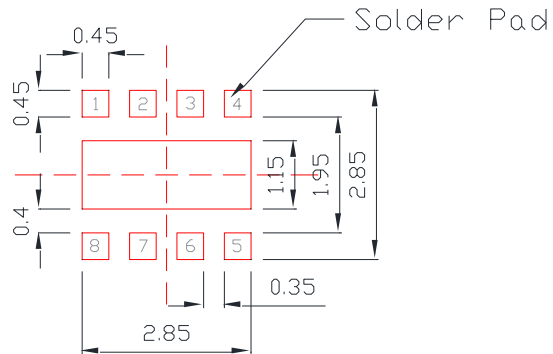

### Solder Resist

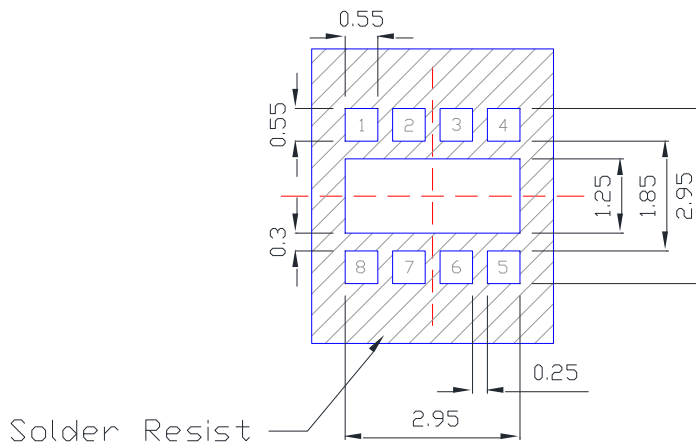

### Solder Stencil

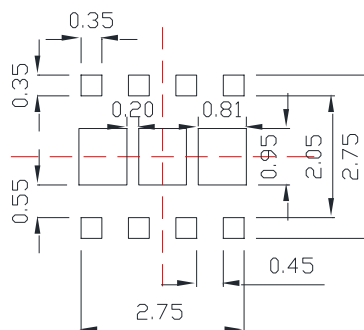

- All dimensions are in millimeters.
- Electrical isolation is required between Slug and Solder Pad.
- Recommended solder stencil thickness is 0.08mm

## Reflow Soldering Condition

Profile Feature	Sn-Pb Eutectic Assembly	Pb-Free Assembly
Average Ramp-Up Rate ( $T_{Smax}$ to $T_p$ )	3°C / second max.	3°C / second max.
Preheat <ul style="list-style-type: none"> <li>– Temperature Min (<math>T_{Smin}</math>)</li> <li>– Temperature Max (<math>T_{Smax}</math>)</li> <li>– Time (<math>t_{Smin}</math> to <math>t_{Smax}</math>)</li> </ul>	100°C 150°C 60-120 seconds	150°C 200°C 60-180 seconds
Time maintained above: <ul style="list-style-type: none"> <li>– Temperature (<math>T_L</math>)</li> <li>– Time (<math>t_L</math>)</li> </ul>	183°C 60-150 seconds	217°C 60-150 seconds
Peak/Classification Temperature ( $T_p$ )	240°C	260°C
Time Within 5°C of Actual Peak Temperature ( $t_p$ )	10-30 seconds	20-40 seconds
Ramp-Down Rate	6°C/second max.	6°C/second max.
Time 25°C to Peak Temperature	6 minutes max.	8 minutes max.

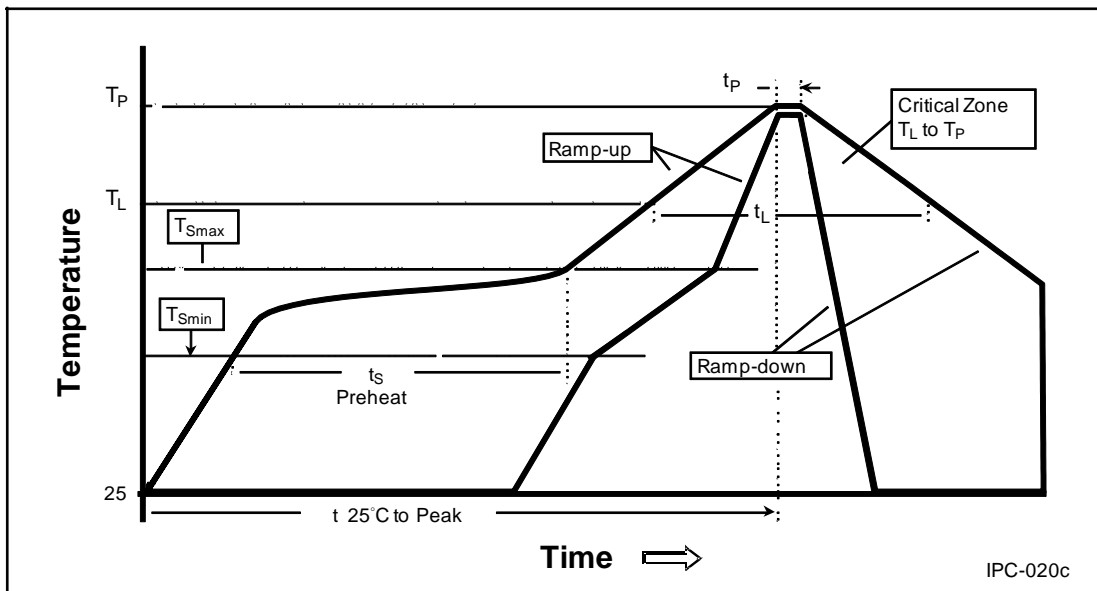

- We recommend using the M705-S101-S4 solder paste from SMIC (Senju Metal Industry Co., Ltd.) for lead-free soldering.
- Do not use solder pastes with post reflow flux residue > 47%. (58Bi-42Sn eutectic alloy, etc) This kind of solder pastes may cause a reliability problem to LED.
- All temperatures refer to topside of the package, measured on the package body surface.
- Repairing should not be done after the LEDs have been soldered. When repairing is unavoidable, a double-head soldering iron should be used. It should be confirmed beforehand whether the characteristics of the LEDs will or will not be damaged by repairing.
- Reflow soldering should not be done more than three times.
- When soldering, do not put stress on the LEDs during heating.
- After soldering, do not warp the circuit board.

## Emitter Reel Packaging

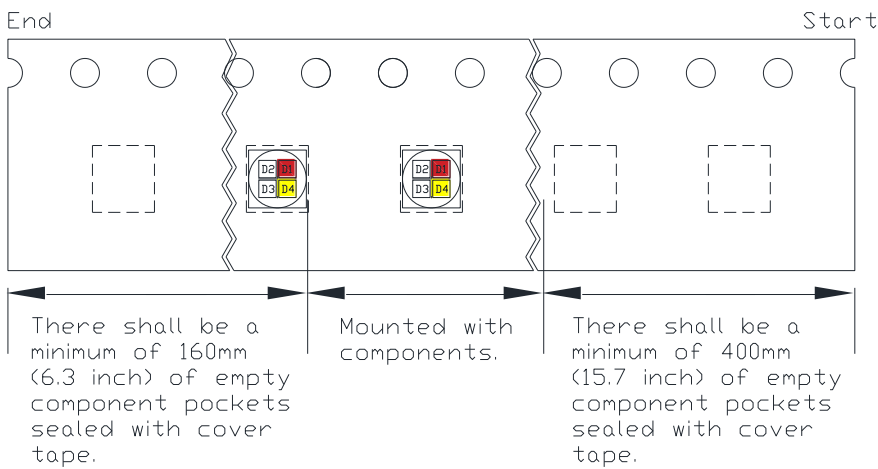
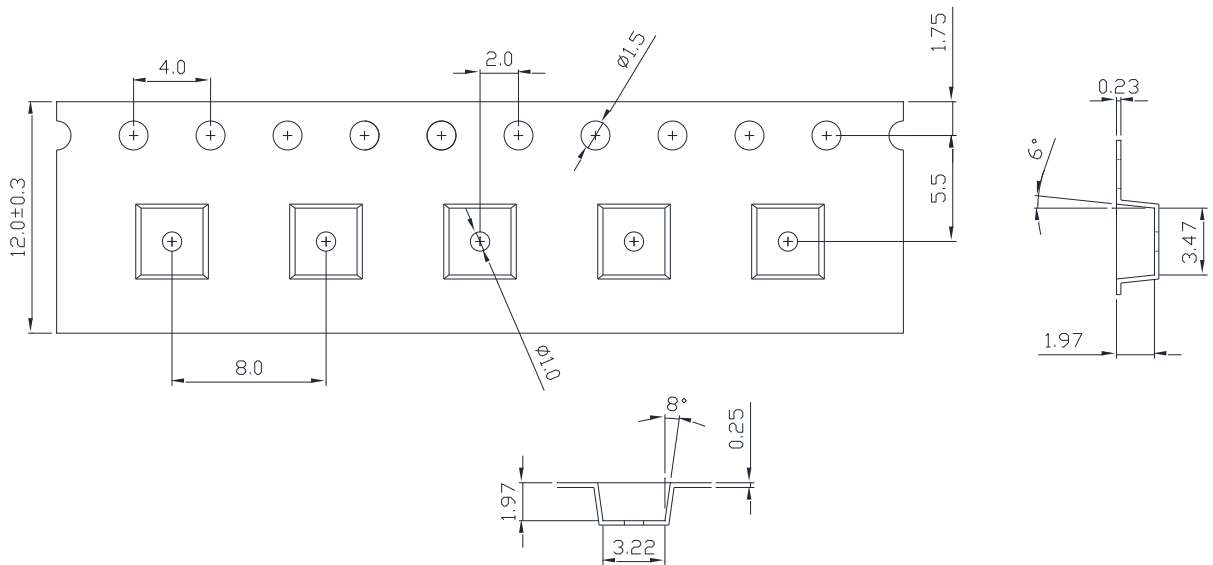

### Notes:

1. Drawing not to scale.
2. All dimensions are in millimeters.
3. Unless otherwise indicated, tolerances are  $\pm 0.10$ mm.



## Emitter Reel Packaging

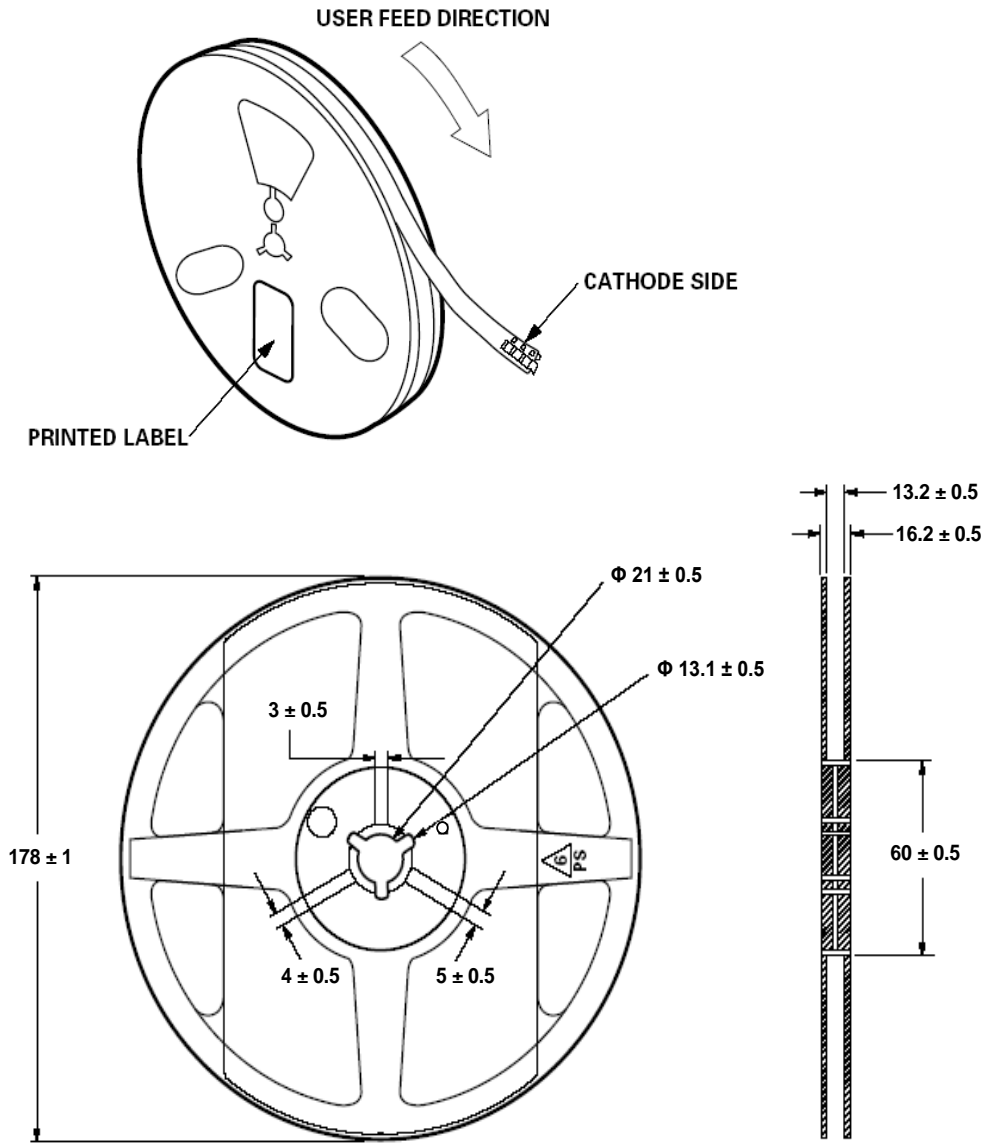

Notes:

1. Empty component pockets sealed with top cover tape.
2. 250, 500 and 1000 pieces per reel.
3. Drawing not to scale.
4. All dimensions are in millimeters.

## Precaution for Use

- We recommend using the M705-S101-S4 solder paste from SMIC (Senju Metal Industry Co., Ltd.) for lead-free soldering.
- Do not use solder pastes with post reflow flux residue > 47%. (58Bi-42Sn eutectic alloy, etc) This kind of solder pastes may cause a reliability problem to LED.
- Electric Static Discharge (ESD) Protection  
The LEDs are **STATIC SENSITIVE** device. ESD protection or surge voltages shall be considered and taken care in the initial design stage, and whole production process. The following protection is recommended:  
(1) A wrist band or an anti-electrostatic glove shall be used when handling the LEDs.  
(2) All devices, equipment and machinery must be properly grounded.
- Any mechanical force or any excess vibration shall not be accepted to apply during cooling process to normal temperature after soldering.
- Please avoid rapid cooling after soldering.
- Components should not be mounted on warped direction of PCB.
- Repairing should not be done after the LEDs have been soldered. When repairing is unavoidable, a heat plate should be used. It should be confirmed beforehand whether the characteristics of the LEDs will or will not be damaged by repairing.
- This device should not be used in any type of fluid such as water, oil, organic solvent and etc. When cleaning is required, isopropyl alcohol should be used.
- When the LEDs are illuminating, operating current should be decided after considering the package maximum temperature.
- The appearance, specifications and flux bin of the product may be modified for improvement without notice. Please refer to the below website for the latest datasheets.  
<http://www.prolightopto.com/>

## Handling of Lens LEDs

Notes for handling of lens LEDs

- Please do not use a force of over 1kgf impact or pressure on the lens, otherwise it will cause a catastrophic failure.
- The LEDs should only be picked up by making contact with the sides of the LED body.
- Avoid touching the lens especially by sharp tools such as Tweezers.
- Avoid leaving fingerprints on the lens.
- Please store the LEDs away from dusty areas or seal the product against dust.
- Please do not mold over the lens with another resin. (epoxy, urethane, etc)

