

1. Scope of Application

These specifications are applied to the chip type LED lamp , model CL-L400-MC1L1-A-T

2. Part code

CL - L400 - MC1L1 - A - T

Series

L400 : White power LED for general lighting.

Special Specifications

M : General Color Rendering Index Typ. 83 Type.

Watt Class

C1 : 1 watt package.

Lighting color

L1 : ANSI C78,377-2008 Correlated Color Temperature 3000(K)
MacAdam ellipse 3step

Shipping mode

Non-coded : Bulk
T : Taping (standard)

Symbol	CITILED
Name	CL-L400-MC1L1-A
CITIZEN ELECTRONICS CO., LTD. JAPAN	

3. Outline drawing

Unit : mm
Tolerance : ±0.1mm

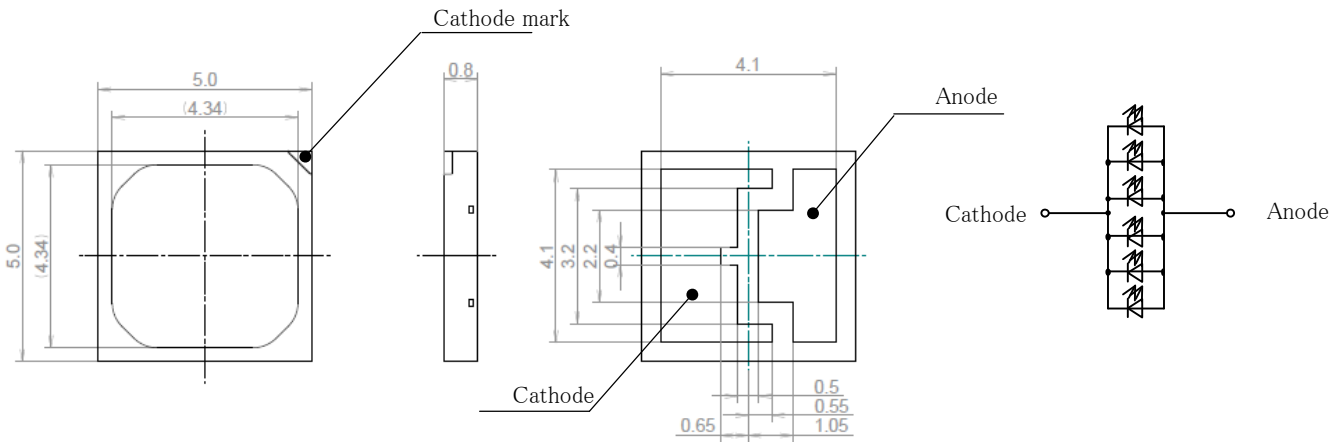

4. Performance

(1) Absolute Maximum Rating

Parameter	Symbol	Rating Value	Unit
Power Dissipation	P_D	2.0	W
Forward Current	I_F	600	mA
Forward Pulse Current	I_{FP}	720	mA
Reverse Voltage	V_R	5	V
Operating Temperature	T_{OP}	-30 ~ +85	C
Storage Temperature	T_{ST}	-40 ~ +100	C
Junction Temperature	$T_{j_{Max}}$	120	C

*1 Forward Current : Duty≤1/10 , Pulse Width≤10msec

*2 D.C. Current : $T_j = T_s + R_j \cdot s \times P_D$

Pulse Current : $T_j = T_s + R_j \cdot s \times P_w$ (Power Dissipation / one-Pulse) × duty

T_s : Temperature of solder terminal

Symbol	CITILED
Name	CL-L400-MC1L1-A
CITIZEN ELECTRONICS CO., LTD. JAPAN	

(2) Electro-optical Characteristics

(Ts=25 C)

Parameter	Symbol	Condition	Min.	Typ.	Max.	Unit
Forward Voltage	V_F	$I_F=350mA$	2.80	3.10	3.40	V
Luminous Flux	Φ_v	$I_F=350mA$	80	106	-	lm
Luminous Flux	Φ_v	$I_F=480mA$	-	(140)	-	lm
General Color Rendering Index	Ra	$I_F=350mA$	80	83	-	-
Thermal Resistance	R_{j-s}	Junction-solder	-	9.0	-	C/W

Chromaticity coordinates

Condition : $I_F=350mA$ $T_s=25C$

Color rank	x	y	
L1	Center	0.4338	0.4030
	a	0.4147	0.3814
	b	0.4299	0.4165
	c	0.4562	0.4260
	d	0.4373	0.3893

*MacAdam ellipse 3 step from center point.

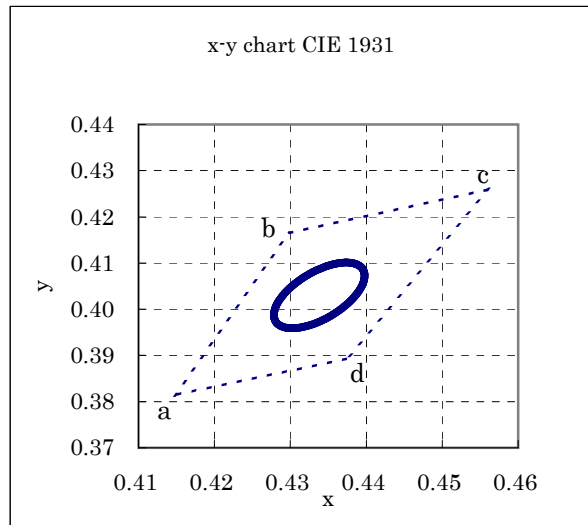

Ranking (Condition : $I_F=350mA$, $T_s=25 C$)

Parameter	Symbol	Rank	Min.	Max.	Unit
Forward Voltage	V_F	Q	2.80	3.00	V
		R	3.00	3.20	
		S	3.20	3.40	
Luminous Flux	Φ_v	C	80	133	lm

Note: The tolerance of measurement at our tester is $V_F \pm 3\%$, $\Phi_v \pm 10\%$, Chromaticity(x,y) ± 0.005 .

Symbol	CITILED
Name	CL-L400-MC1L1-A
CITIZEN ELECTRONICS CO., LTD. JAPAN	

5. Characteristics

•Forward Current vs. Forward Voltage

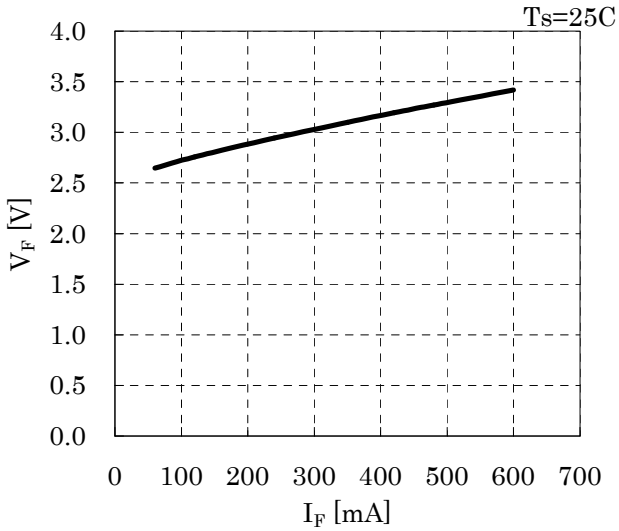

•Forward Current vs. Relative Luminous Flux

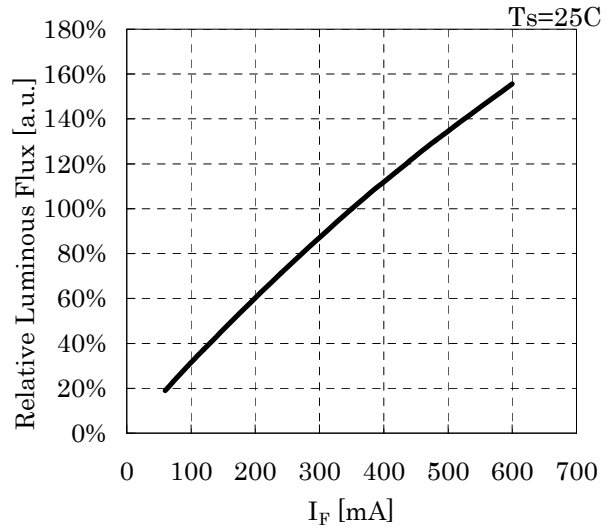

•Forward Current vs. Chromaticity Coordinate

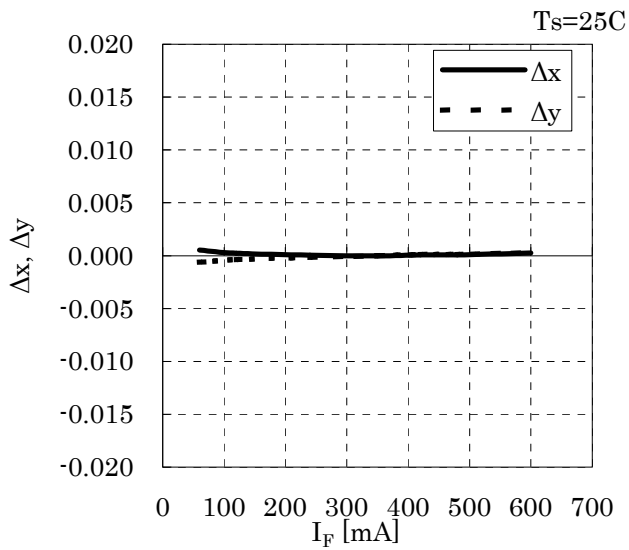

•Solder Temperature vs. Chromaticity Coordinate

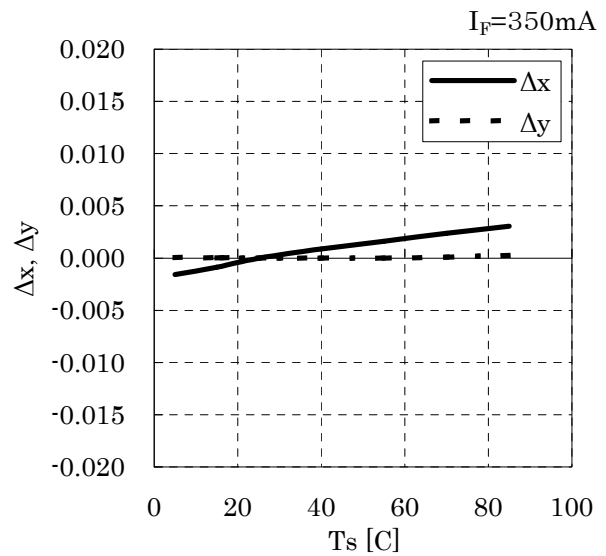

Symbol	CITILED
Name	CL-L400-MC1L1-A
CITIZEN ELECTRONICS CO., LTD. JAPAN	

• Solder Temperature vs. Forward Voltage

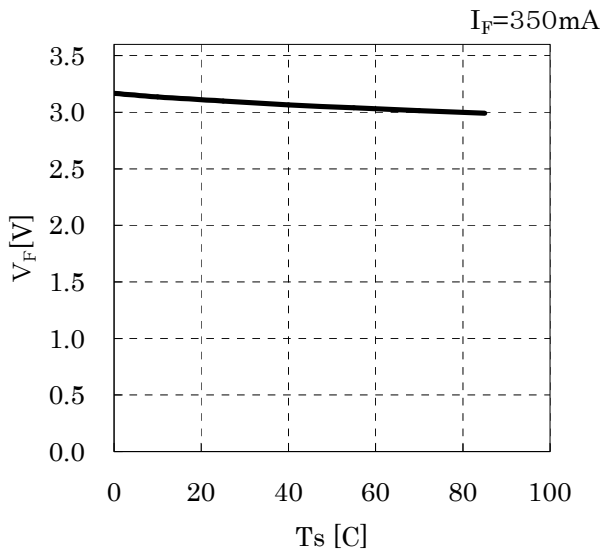

• Solder Temperature vs. Relative Luminous Flux

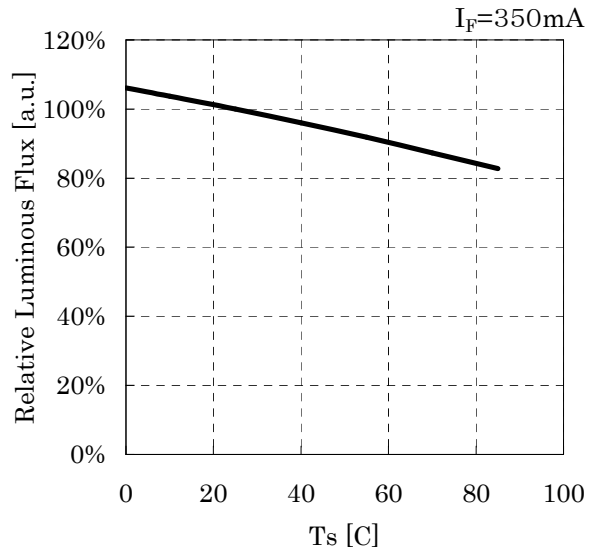

• Solder Temperature vs. Allowable Forward Current • Spectrum

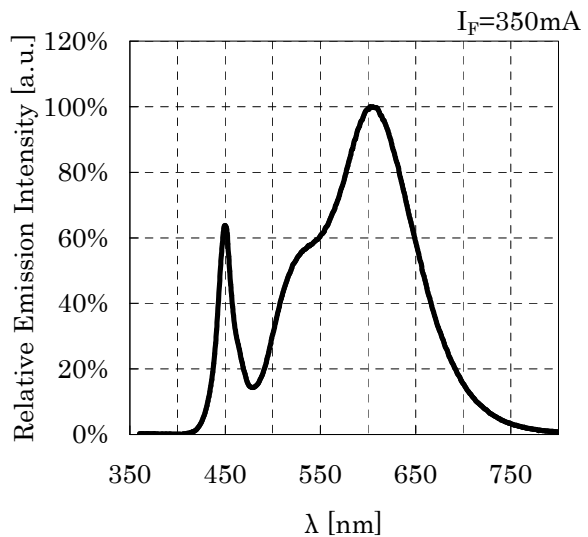
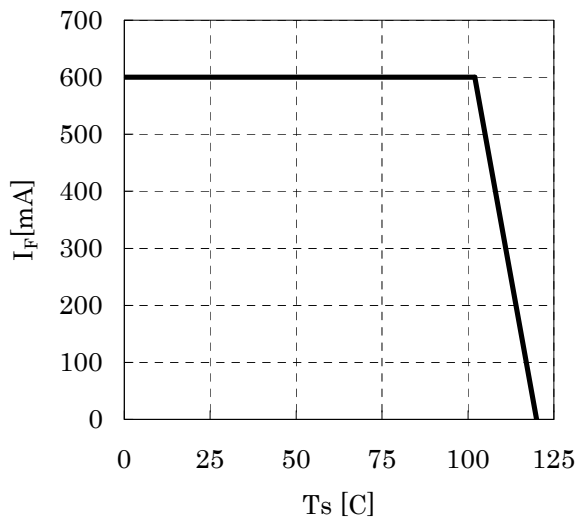

• Directive Characteristics

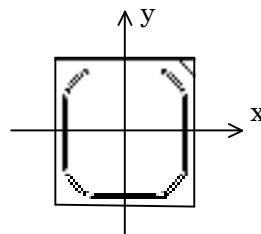
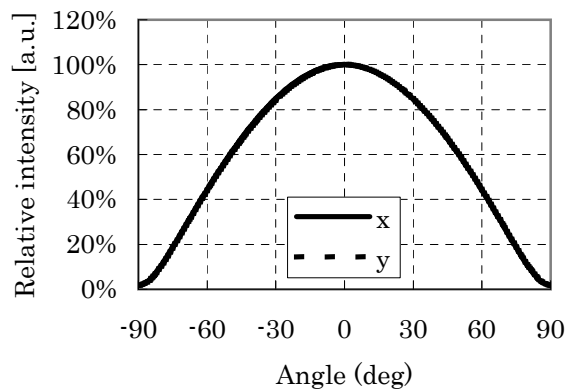

Symbol	CITILED
Name	CL-L400-MC1L1-A
CITIZEN ELECTRONICS CO., LTD. JAPAN	

6. Reliability

(1) Details of the tests

Test Item	Test Condition
Continuous Operation Test	Ta=25 C, I _F =350 mA× 1000 hours
Low Temperature Storage Test	Ta=-40 C × 1000 hours
High Temperature Storage Test	Ta=100 C × 1000 hours
Moisture-proof Test	Ta=60 C, 90 %RH for 1000 hours
Thermal Shock Test	-40 C × 30 minutes – 100 C × 30 minutes, 100 cycle
Solder Heat Resistance Test	Recommended temperature profile (reflow soldering) × 2, (2nd test must be started after the samples are stabilized thermally.)

(2) Judgment Criteria of Failure for Reliability Test (Ta=25 C)

Measuring Item	Symbol	Measuring Condition	Judgment Criteria for Failure
Forward Voltage	V _F	I _F =350mA	> U × 1.2
Total Luminous Flux	Φ _V	I _F =350mA	< S × 0.7

U defines the upper limit of the specified characteristics. S defines the initial value.

Note: Measurement shall be taken between 2 hours and 24 hours, and the test pieces should be returned to the normal ambient conditions after the completion of each test.

Symbol	CITILED
Name	CL-L400-MC1L1-A
CITIZEN ELECTRONICS CO., LTD. JAPAN	

7. Taping Specifications (in accordance with JIS standard)

(1) Shape and dimensions of Reel

Unit:mm

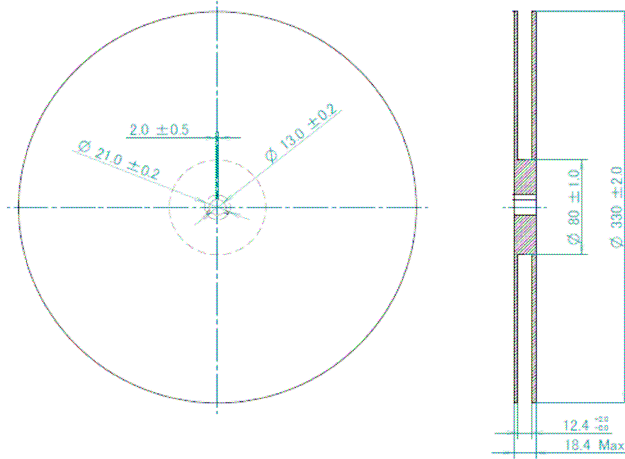

(2) Dimensions of Tape

Unit:mm

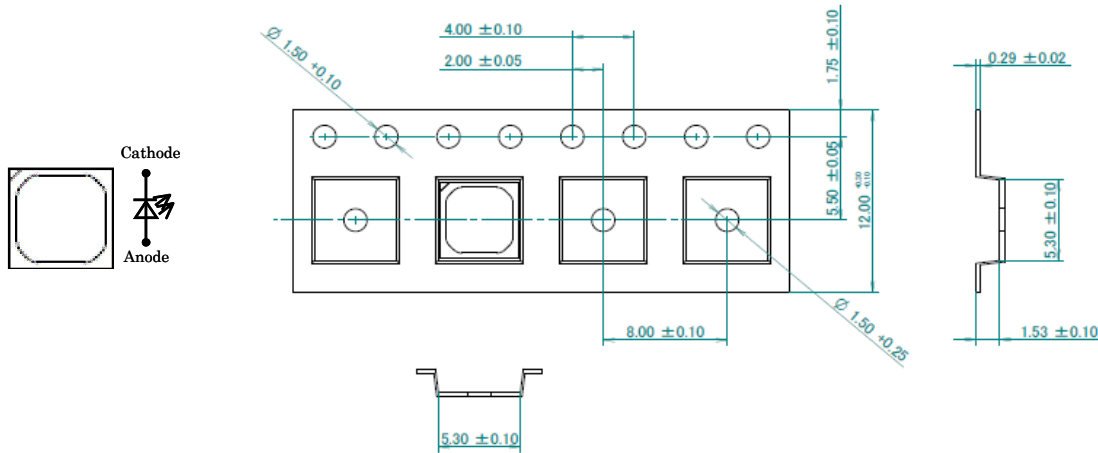

(3) Configuration of Tape

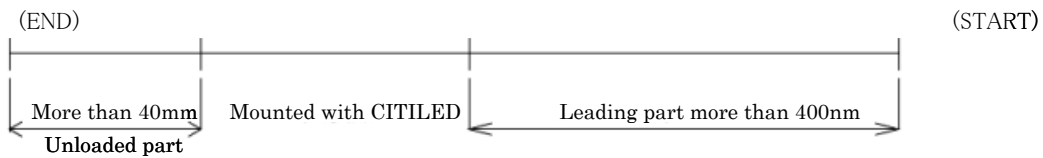

(4) Quantity : 4000 pcs/reel

Symbol	CITILED
Name	CL-L400-MC1L1-A
CITIZEN ELECTRONICS CO., LTD. JAPAN	

8. Packing Specifications

8-1. Moisture-proof Packing

To prevent moisture absorption during transportation and storage, reels are packed in aluminum envelopes which contain a desiccant with a humidity indicator.

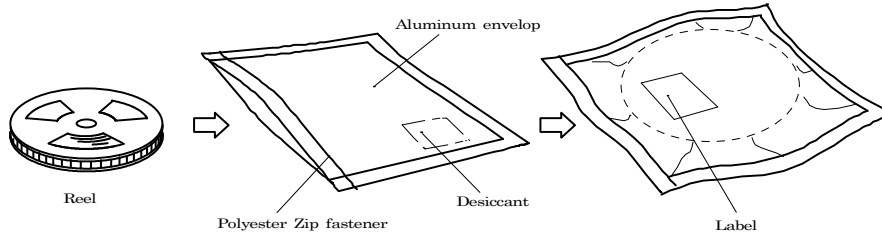

8-2. Storage

To prevent moisture absorption, it is strongly recommended that reels (in bulk or taped) should be stored in the dry box (or the desiccator) with a desiccant as the appropriate storage place. If not, the following is recommended.

Temperature : 5~30C
Humidity : 60%RH max.

The devices should be mounted within 168H (7days) after unpacking.

If you store the unpacked reels, please store them in the dry box or seal them into the envelop again.

8-3. Other (storage and using conditions)

This device contain silver plated electrode. So, when being exposed to enviroment which contains corrosive gases, the silver plating becomes tarnished. Tarnished plating may lead to poor solderbility and degradation of optical characteristics.

Please DO NOT expose this device to corrosive atomosphere anytime (during storage, or after mount)
Please take care the above when designing your product.

Symbol	CITILED
Name	CL-L400-MC1L1-A
CITIZEN ELECTRONICS CO., LTD. JAPAN	

9. Precautions

9-1 Handling precaution

- (1). Avoid the application of any stress to the encapsulant.
- (2). Avoid any contact by a sharp metal nail or other materials with the encapsul

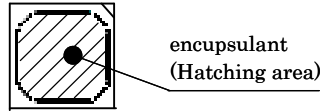

(3). Pick and Place

Recommend condition : nozzle inner radius $\geq \phi 4.4\text{mm}$
 Avoid direct contact to the encapsulant with the nozzle.

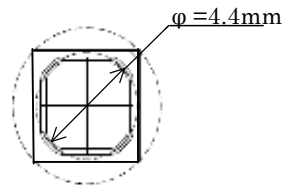

ex : pick up area

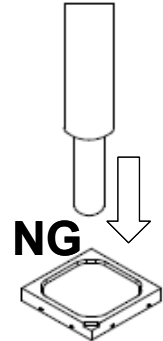

Bad ex : narrow nozzle

(4). PCB handling

Bending the circuit board with soldered LEDs may cause breakage of LEDs.
 Please take care to bow, twist, and warp the PCB.



9-2. Lighting at a low current

A minimum current value of lighting of all dice is 30mA.
 When a minimal current is applied, LED dice may look different in their brightness due to the individual difference of the LED element, and it is not a failed product.

9-3. Handling of static electricity

- These products are sensitive to static electricity charge.
 Please take measures to prevent any static electricity being produced such as the wearing of a wristband or anti-static gloves when handling this product.
- All devices, equipment and machinery must be properly grounded. It is recommended that precautions be taken against surge voltage to the equipment that mounts the LEDs.
- When inspecting the final products in which LEDs were assembled, it is recommended to check whether the assembled LEDs are damaged by static electricity or not.
- It is easy to find static-damaged LEDs by a light-on test.

<Light-on test criterion>

Condition	Judgmental criterion
$I_F=6\text{mA}/\text{PKG}$	No-lighting die in package is unacceptable

Symbol	CITILED
Name	CL-L400-MC1L1-A
CITIZEN ELECTRONICS CO., LTD. JAPAN	

9-4. Designing precaution

- A constant current circuit is recommended as a drive circuit.
When using two or more LED packages, connect current limiting resistor in series on each path is recommended.

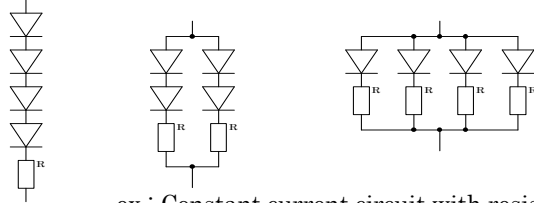

- Please design a circuit that prevents any reverse voltage (excess current) from being applied to this product instantaneously when the circuit is ON or OFF.
- CL-L400 has small electrode at the side of package.
Please take care about shortage with conductive rubbish.

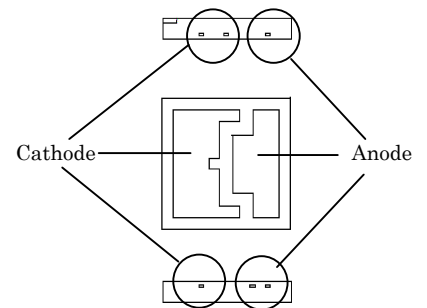

fig : small electrode

9-5. Soldering

(1) Lead free soldering

- 1) Following soldering paste is recommended

Melting temperature : 216 ~ 220C.

Composition : Sn 3.5Ag 0.75Cu

- 2) The temperature profile at the top surface of the parts is recommended as shown below.

- 3) It is requested that products should be handled after their temperature has dropped down to the normal room temperature

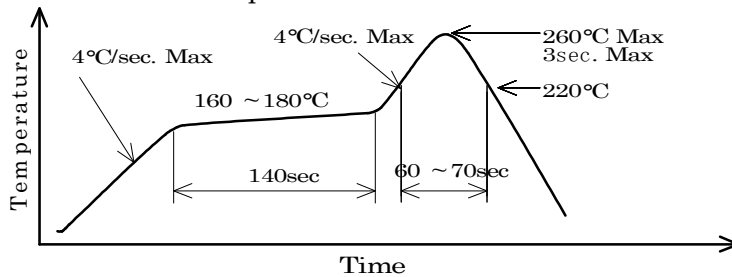

(2) Recommended soldering pattern

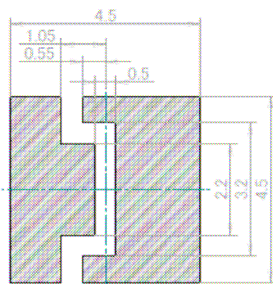

- Mountability and solderability need to be optimized with actual conditions such as amount of solder, reflow temperature applied in the process.

Symbol	CITILED
Name	CL-L400-MC1L1-A
CITIZEN ELECTRONICS CO., LTD. JAPAN	

9-6. Heat generation

- As this product is designed with consideration of the heat release property of module, a heat release design is required to use this product efficiently.
Please ensure that heat generation is not in excess of the absolute maximum rating.
(Refer to 4-1 Performance)
 - Factors responsible for an increase in temperature include heat generation attributed to ambient temperature conditions or power dissipation. Thus, drive conditions should be taken into consideration, depending on ambient temperature (Ta).
- * Citizen Electronics cannot guarantee if usage exceeds this recommended conditions.
Please use it after sufficient verification is carried out on your own risk if necessary.

9-7. Eye Safety

- The International Electrical Commission (IEC) published in 2006 IEC 62471 *"2006 Photobiological safety of lamps and lamp systems"* which includes LEDs within its scope. When sorting single LEDs according to IEC 62471, most LEDs can be classified as belonging to either Exempt Group or Risk Group 1.
- Optical characteristics of LEDs such as radiant flux, spectrum and light distribution are factors that affect the risk group determination of the LED, and especially a high-power LED, that emits light containing blue wavelengths, may have properties equivalent to those of Risk Group 2.
- Great care should be taken when directly viewing an LED that is driven at high current, has multiple uses as a module or when focusing the light with optical instruments, as these actions may greatly increase the hazard to your eyes.
- In addition, LED sources that were included within the scope of IEC 60825-1 / Edition 1.2 "laser safety standard", published 2001 were removed from the scope of the IEC 60825-1 / Edition 2.0 revised 2007.
- However, keep in mind that some countries and regions have adopted standards based on the IEC laser safety standard IEC 60825-1:2001 which includes LEDs within its scope.

9-7. Other

This product complies with RoHS directives.

Symbol	CITILED
Name	CL-L400-MC1L1-A
CITIZEN ELECTRONICS CO., LTD. JAPAN	

9. Precautions with regard to product use

1. This document is provided for reference purposes only so that CITIZEN ELECTRONICS' products are used as intended. CITIZEN ELECTRONICS neither makes warranties or representations with respect to the accuracy or completeness of the information contained in this document nor grants any license to any intellectual property rights or any any other rights of CITIZEN ELECTRONICS or any third party with respect to the information in this document.
2. All information included in this document such as product data, diagrams, charts, is current as of the date this document is issued.
Such information, however, is subject to change without any prior notice.
Before purchasing or using any CITIZEN ELECTRONICS' products listed in this document, please confirm the latest product information with a CITIZEN ELECTRONICS' sales office, and formal specifications must be exchanged and signed by both parties prior to mass production.
3. CITIZEN ELECTRONICS has used reasonable care in compiling the information included in this document, but CITIZEN ELECTRONICS assumes no liability whatsoever for any damages incurred as a result of errors or omissions in the information included in this document.
4. Absent a written signed agreement, except as provided in the relevant terms and conditions of sale for product, and to the maximum extent allowable by law, CITIZEN ELECTRONICS assumes no liability whatsoever, including without limitation, indirect, consequential, special, or incidental damages or loss, including without limitation, loss of profits, loss of opportunities, business interruption and loss of data, and disclaims any and all express or implied warranties and conditions related to sale, use of product, or information, including warranties or conditions of merchantability, fitness for a particular purpose, accuracy of information, or no infringement.
5. Though CITIZEN ELECTRONICS works continually to improve products' quality and reliability, products can malfunction or fail. Customers are responsible for complying with safety standards and for providing adequate designs and safeguards to minimize risk and avoid situations in which a malfunction or failure of a product could cause loss of human life, bodily injury or damage to property, including data loss or corruption.
In addition, customers are also responsible for determining the appropriateness of use of any information contained in this document such as application cases not only with evaluating by their own but also by the entire system.
CITIZEN ELECTRONICS assumes no liability for customers' product design or applications.
6. Please contact CITIZEN ELECTRONICS' sales office if you have any questions regarding the information contained in this document, or if you have any other inquiries.

Symbol	CITLED
Name	CL-L400-MC1L1-A
CITIZEN ELECTRONICS CO., LTD. JAPAN	