



**ProLight PACL-115FxL-xCGN
115W COB Light-Engine LEDs
Technical Datasheet
Version: 1.1**

ProLight Opto ® ProEngine Series

Features

- High flux density of lighting source
- Good color uniformity
- RoHS compliant
- Energy Star binning structure, neutral white and warm white with 2 steps guarantee.
- More energy efficient than incandescent and most halogen lamps
- No UV
- Long lifetime
- 5 year warranty

Main Applications

- Stadium light
- Street light
- High Bay
- Spot light
- Flood light
- Low Bay

Introduction

·The input power is 115 Watt, the multi-chip ultra high power ProEngine Series delivers never before seen luminous flux output from a single emitter. The superficial illuminating nature of ProEngine makes them the preference in High Bay, typical applications include, Flood light, Spot light, Stadium light, Low Bay and Street light.

Emitter Mechanical Dimensions

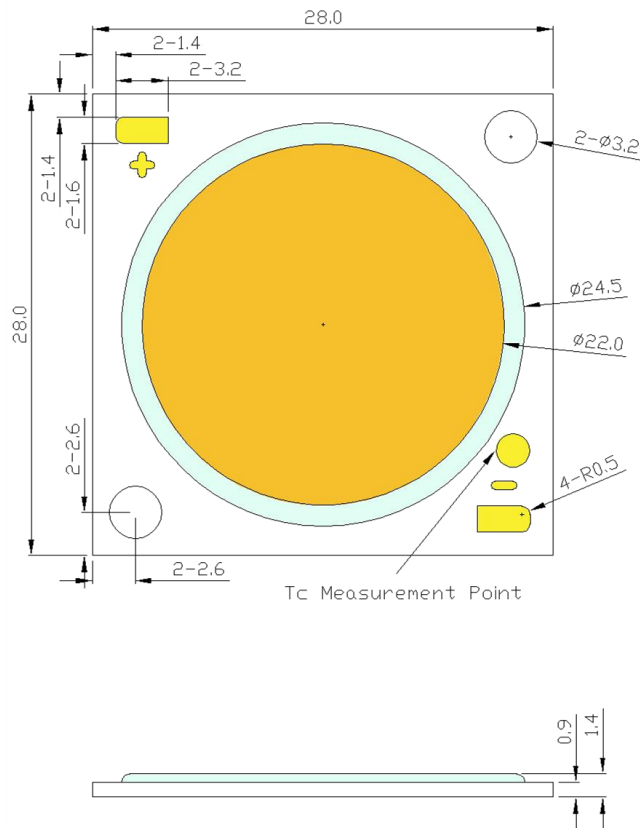

Notes:

1. Slots in aluminum-core PCB for M3 mounting screw.
2. Solder pads are labeled "+" and "-" to denote positive and negative, respectively.
3. Drawing not to scale.
4. All dimensions are in millimeters.
5. Unless otherwise indicated, tolerances are ± 0.30 mm.
6. **Please do not use a force of over 0.3kgf impact or pressure on the lens of the LED, otherwise it will cause a catastrophic failure.**

*The appearance and specifications of the product may be modified for improvement without notice.

Flux Characteristics, $T_c = 25^\circ\text{C}$

Radiation Pattern	Color	Part Number COB	DC Forward Current (mA)	Luminous Flux Min.	Φ_v (lm) Typ.	CRI Min.	R9 Min.
Lambertian	White	PACL-115FWL-ACGN	1440*	7200	8450	70	-
			2880	12750	14960		
	Neutral White	PACL-115FNL-ACGN	1440*	7100	8260	70	-
			2880	12570	14620		
	Warm White	PACL-115FVL-ACGN	1440*	6700	7870	70	-
			2880	11860	13930		
	White	PACL-115FWL-BCGN	1440*	7000	8150	80	0
			2880	12390	14430		
	Neutral White	PACL-115FNL-BCGN	1440*	6900	8050	80	0
			2880	12210	14250		
	Warm White	PACL-115FVL-BCGN	1440*	6600	7650	80	0
			2880	11680	13540		
	White	PACL-115FWL-DCGN	1440*	5760	6640	90	50
			2880	10160	11760		
	Neutral White	PACL-115FNL-DCGN	1440*	5360	6480	90	50
			2880	9440	11440		
	Warm White	PACL-115FVL-DCGN	1440*	5200	6320	90	50
			2880	9280	11120		
Neutral White	PACL-115FNL-ECGN	1440*	5200	6080	95	90	
		2880	9120	10720			
Warm White	PACL-115FVL-ECGN	1440*	4480	5440	95	90	
		2880	7920	9600			

- The mark "*" indicated product is tested and binned at the specified drive current.
- ProLight maintains a tolerance of $\pm 7\%$ on flux and power measurements.
- ProLight maintains a tolerance of ± 2 on CRI measurements.
- Please do not drive at rated current more than 1 second without proper heat sink.

Electrical Characteristics at 1440mA, T_c = 25°C

Color	Forward Voltage V _F (V)			Thermal Resistance Junction to Board (°C/W)
	Min.	Typ.	Max.	
White	33.7	36.0	38.3	0.39
Neutral White	33.7	36.0	38.3	0.39
Warm White	33.7	36.0	38.3	0.39

- ProLight maintains a tolerance of ± 1V for Voltage measurements.

Optical Characteristics at 1440mA, T_c = 25°C

Color	Bin Code	Color Temperature CCT			Total included Angle (degrees) θ _{0.90V}	Viewing Angle (degrees) 2 θ _{1/2}
		Min.	Typ.	Max.		
White	V0	4840 K	5000 K	5230 K	160	120
	W0	5400 K	5700 K	5910 K	160	120
	X0	6250 K	6500 K	6840 K	160	120
Neutral White	S0	3890 K	4000 K	4080 K	160	120
	M0	2660 K	2700 K	2790 K	160	120
Warm White	N0	2970 K	3000 K	3110 K	160	120
	Q0	3380 K	3500 K	3550 K	160	120

- ProLight maintains a tolerance of ± 5% for CCT measurements.

Supply Specifications

Part Number	CRI	Color Bin Code						
		V0	W0	X0	S0	M0	N0	Q0
PACL-115Fxl-ACGN	70	V			V	V		
PACL-115Fxl-BCGN	80	V	V	V	V	V	V	V
PACL-115Fxl-DCGN	90	V			V	V	V	V
PACL-115Fxl-ECGN	95				V	V	V	

Electro-Optical Characteristics, $T_c = 25^\circ\text{C}$

I_F (mA)	V_F (V)	Power (W)	PACL-115FWL-ACGN		PACL-115FNL-ACGN		PACL-115FVL-ACGN	
			Flux (lm)	lm/W	Flux (lm)	lm/W	Flux (lm)	lm/W
960	34.63	33.24	6280	188.9	6140	184.7	5850	176.0
1440*	36.00	51.84	8450	163.0	8260	159.3	7870	151.8
1920	37.23	71.48	10620	148.6	10380	145.2	9890	138.4
2400	38.42	92.21	12790	138.7	12500	135.6	11910	129.2
2880	39.53	113.85	14960	131.4	14620	128.4	13930	122.4
I_F (mA)	V_F (V)	Power (W)	PACL-115FWL-BCGN		PACL-115FNL-BCGN		PACL-115FVL-BCGN	
			Flux (lm)	lm/W	Flux (lm)	lm/W	Flux (lm)	lm/W
960	34.63	33.24	6057	182.2	5983	180.0	5687	171.1
1440*	36.00	51.84	8150	157.2	8050	155.3	7650	147.6
1920	37.23	71.48	10243	143.3	10117	141.5	9613	134.5
2400	38.42	92.21	12337	133.8	12183	132.1	11577	125.5
2880	39.53	113.85	14430	126.7	14250	125.2	13540	118.9
I_F (mA)	V_F (V)	Power (W)	PACL-115FWL-DCGN		PACL-115FNL-DCGN		PACL-115FVL-DCGN	
			Flux (lm)	lm/W	Flux (lm)	lm/W	Flux (lm)	lm/W
960	34.63	33.24	4933	148.4	4827	145.2	4720	142.0
1440*	36.00	51.84	6640	128.1	6480	125.0	6320	121.9
1920	37.23	71.48	8347	116.8	8133	113.8	7920	110.8
2400	38.42	92.21	10053	109.0	9787	106.1	9520	103.2
2880	39.53	113.85	11760	103.3	11440	100.5	11120	97.7
I_F (mA)	V_F (V)	Power (W)	PACL-115FNL-ECGN		PACL-115FVL-ECGN			
			Flux (lm)	lm/W	Flux (lm)	lm/W		
960	34.63	33.24	4533	136.4	4053	121.9		
1440*	36.00	51.84	6080	117.3	5440	104.9		
1920	37.23	71.48	7627	106.7	6827	95.5		
2400	38.42	92.21	9173	99.5	8213	89.1		
2880	39.53	113.85	10720	94.2	9600	84.3		

● All values are reference only.

Absolute Maximum Ratings

Parameter	White/Neutral White/Warm White
Max DC Forward Current (mA)	2880
Max Voltage at 1440mA	42
Peak Pulsed Forward Current (mA)	4320 (less than 1/10 duty cycle@1KHz)
ESD Sensitivity (HBM per MIL-STD-883E Method 3015.7)	±2000V
LED Junction Temperature	120°C
Operating Board Temperature at Maximum DC Forward Current	-40°C - 90°C
Storage Temperature	-40°C - 120°C
Reverse Voltage	Not designed to be driven in reverse bias

Color Bin

White Binning Structure Graphical Representation

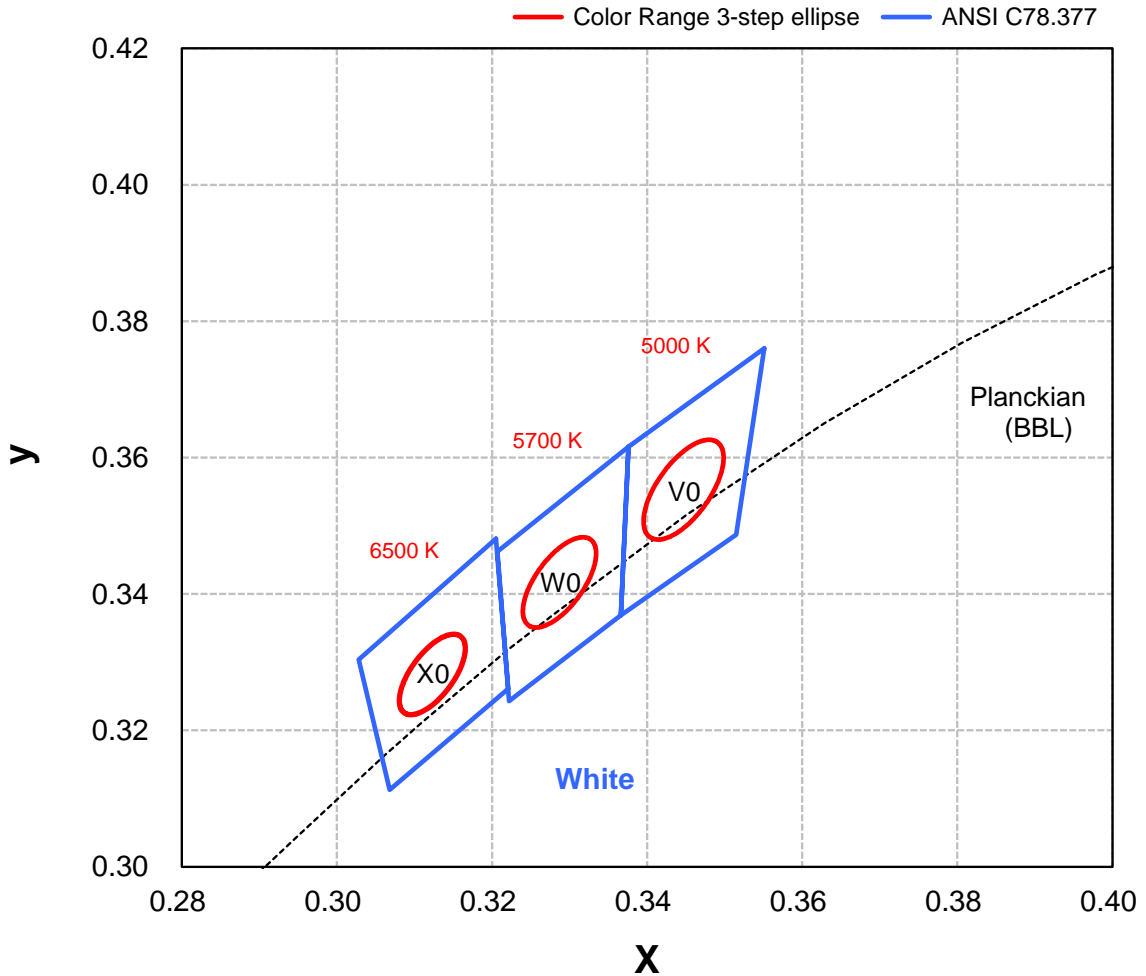

White Bin Structure

Bin Code	Center	Oval parameter	Typ. CCT (K)	Bin Code	Center	Oval parameter	Typ. CCT (K)
V0	x	a	5000	X0	x	a	6500
	y	b			y	B	
		e°				e°	
W0	x	a	5700				
	y	B					
		e°					

- Color range stay within MacAdam “3-step” ellipse from the chromaticity center.
- The chromaticity center refers to ANSI C78.377.
- Tolerance on each color bin (x , y) is ± 0.005

Color Bin

Neutral White Binning Structure Graphical Representation

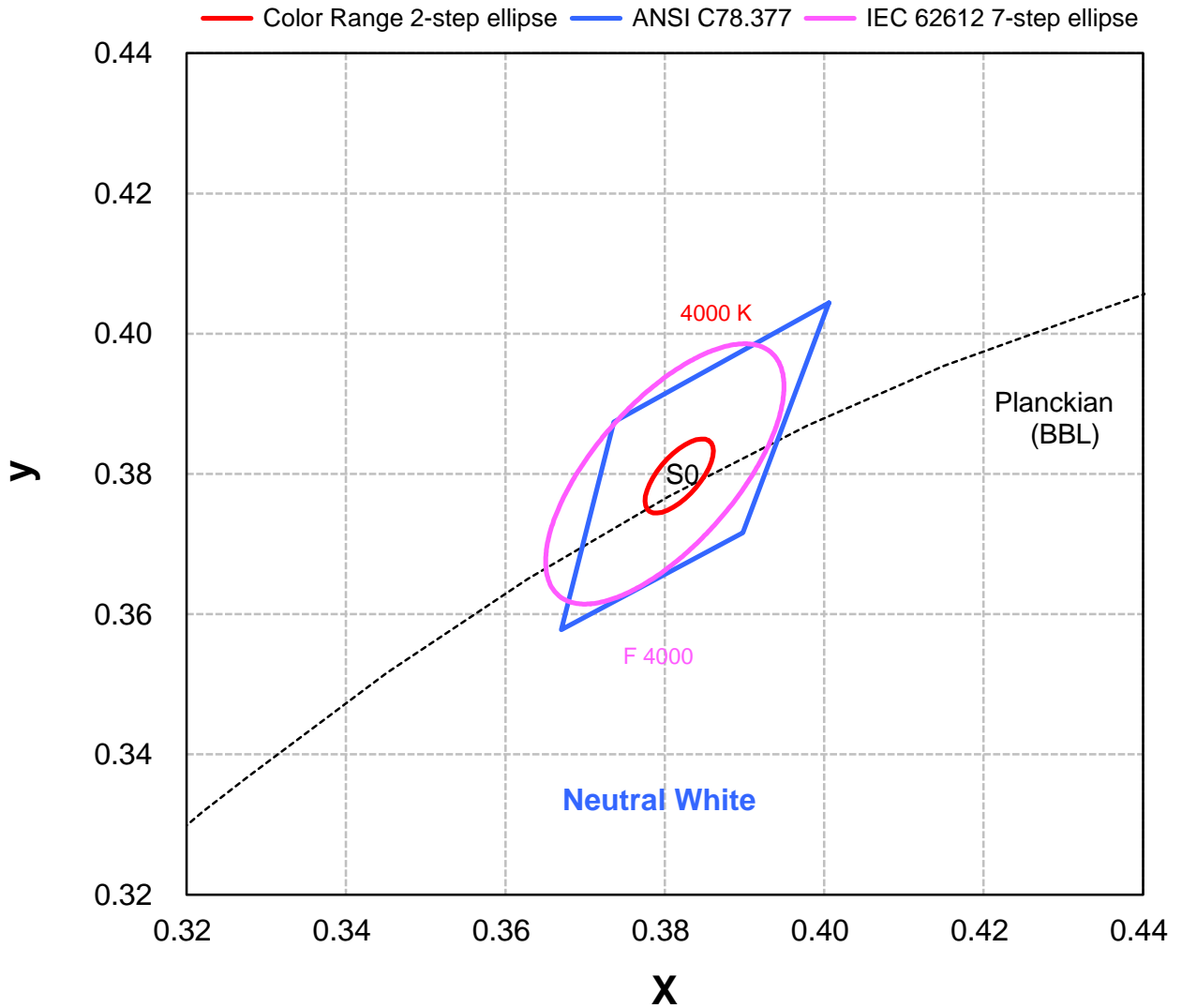

Neutral White Bin Structure

Bin Code	Center	Oval parameter	Typ. CCT (K)
S0	x	0.3818	4000
	y	0.3797	
	a	0.00626	
	b	0.00268	
		e°	53.72

- Color range stay within MacAdam "2-step" ellipse from the chromaticity center.
- The chromaticity center refers to ANSI C78.377.
- Tolerance on each color bin (x , y) is ± 0.005

Color Bin

Warm White Binning Structure Graphical Representation

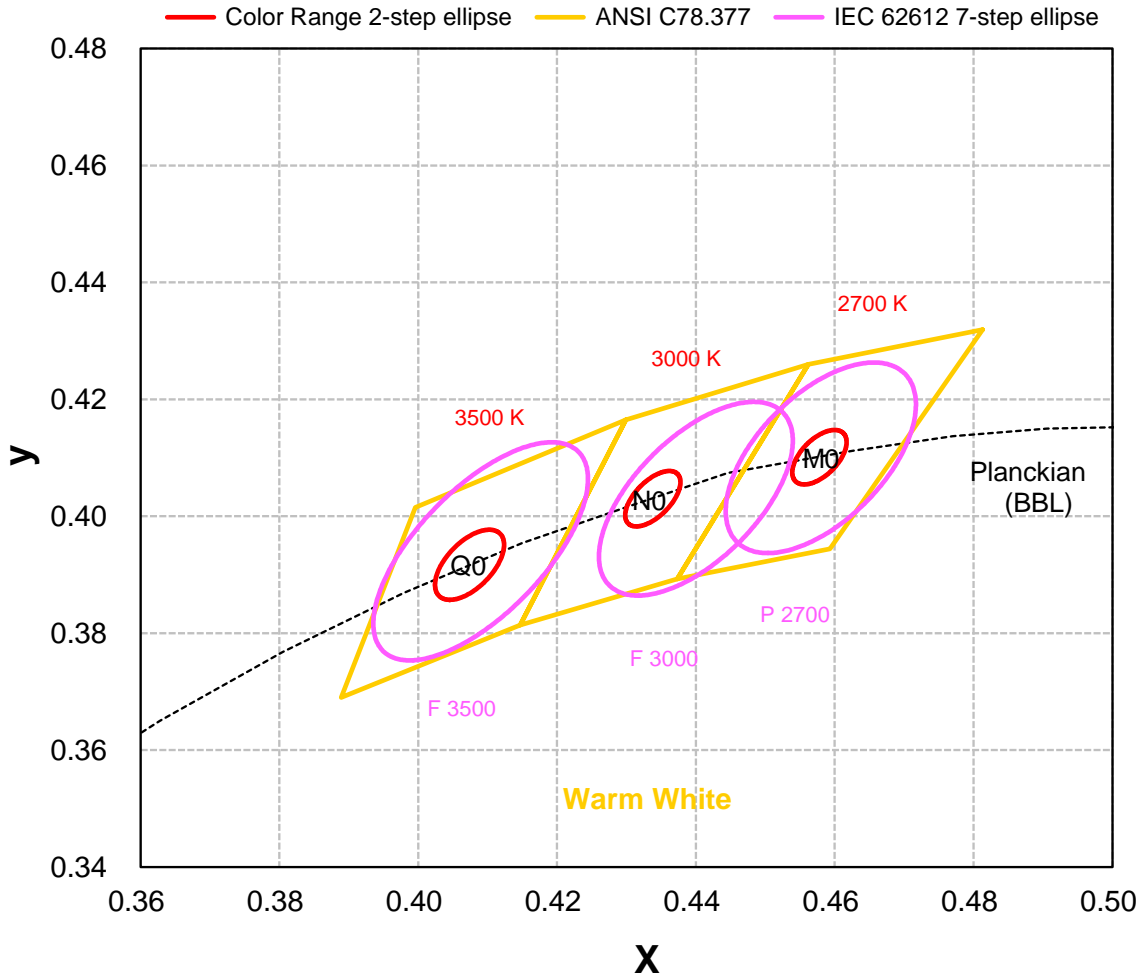

Warm White Bin Structure

Bin Code	Center	Oval parameter	Typ. CCT (K)	Bin Code	Center	Oval parameter	Typ. CCT (K)
M0	x	a	2700	Q0	x	a	3500
	y	b			y	b	
		e°				e°	
N0	x	a	3000				
	y	b					
		e°					

- Color range stay within MacAdam “2-step” ellipse from the chromaticity center.
- The chromaticity center refers to ANSI C78.377.
- Tolerance on each color bin (x , y) is ± 0.005

Color Spectrum, $T_c = 25^\circ\text{C}$

1. PACL-115FWL-ACGN 、 PACL-115FNL-ACGN 、 PACL-115FVL-ACGN

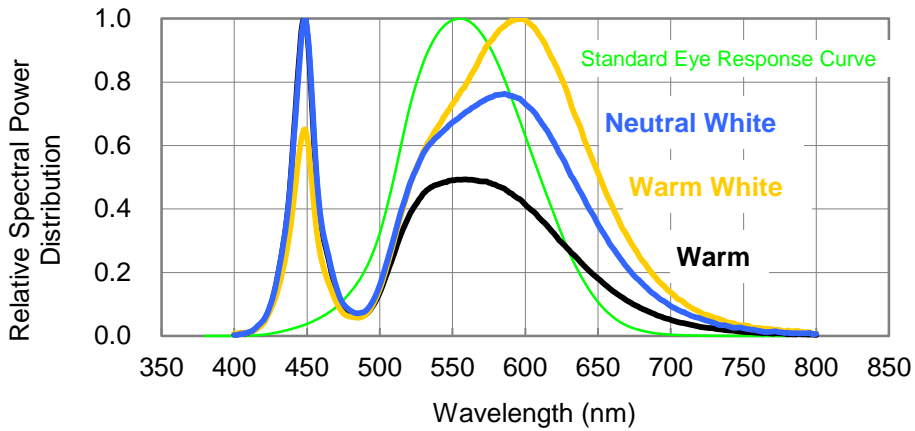

2. PACL-115FWL-BCGN 、 PACL-115FNL-BCGN 、 PACL-115FVL-BCGN

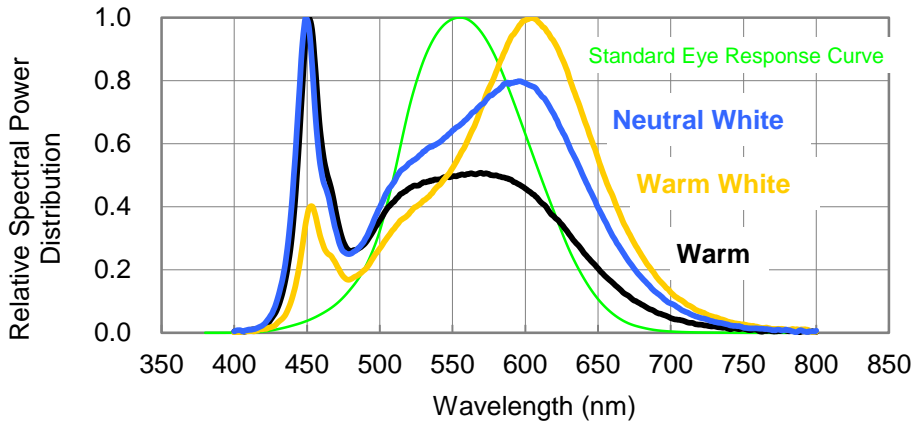

Color Spectrum, $T_c = 25^\circ\text{C}$

3. PACL-115FWL-DCGN、PACL-115FNL-DCGN、PACL-115FVL-DCGN

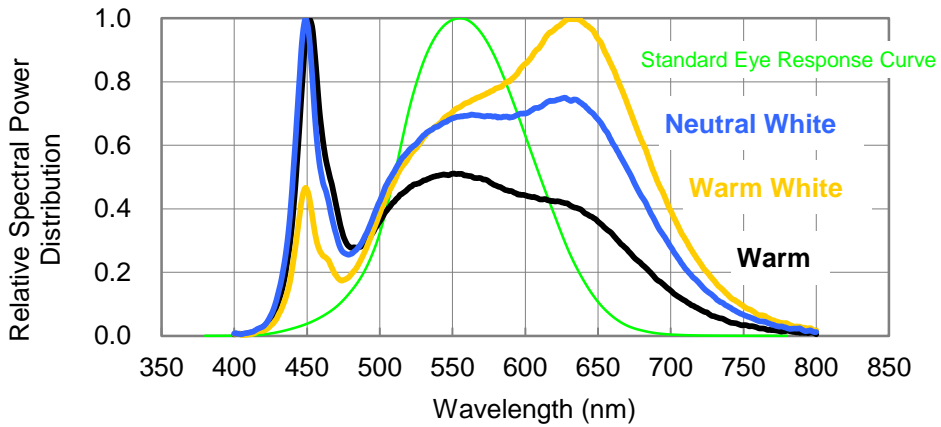

4. PACL-115FNL-ECGN、PACL-115FVL-ECGN

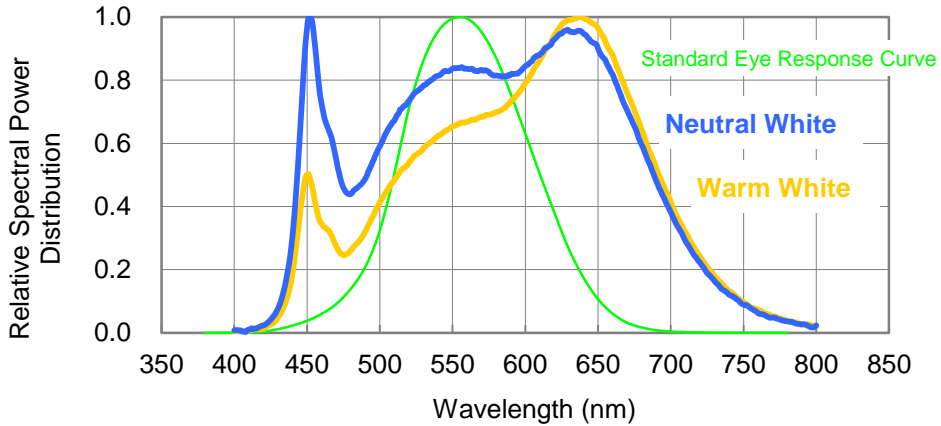

Case Temperature Relative Characteristics

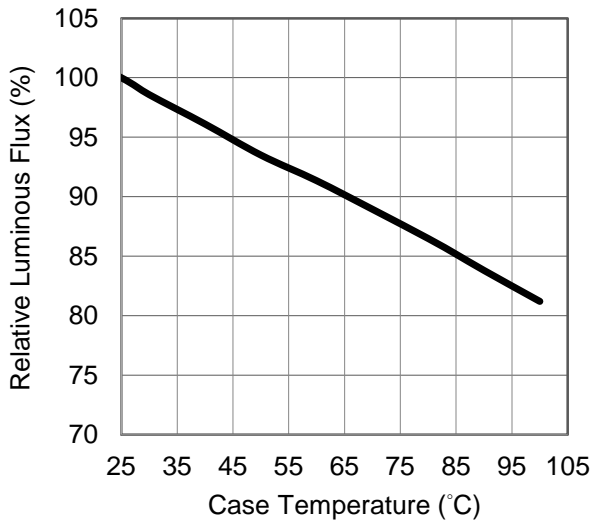

Fig 1. Case Temperature vs. Relative Luminous Flux at 1440mA.

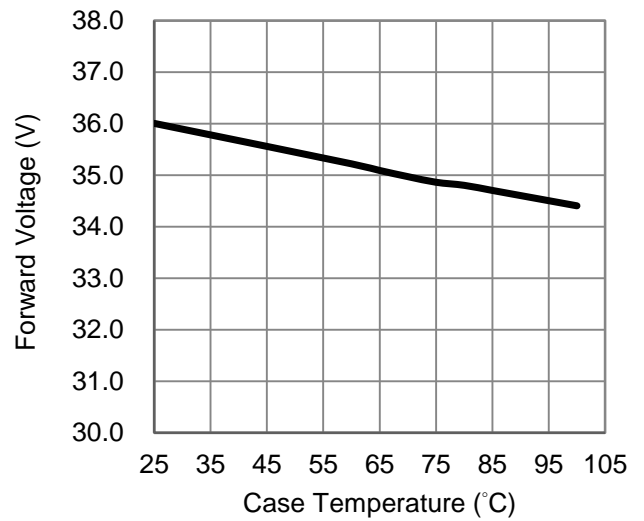

Fig 2. Case Temperature vs. Forward Voltage at 1440mA.

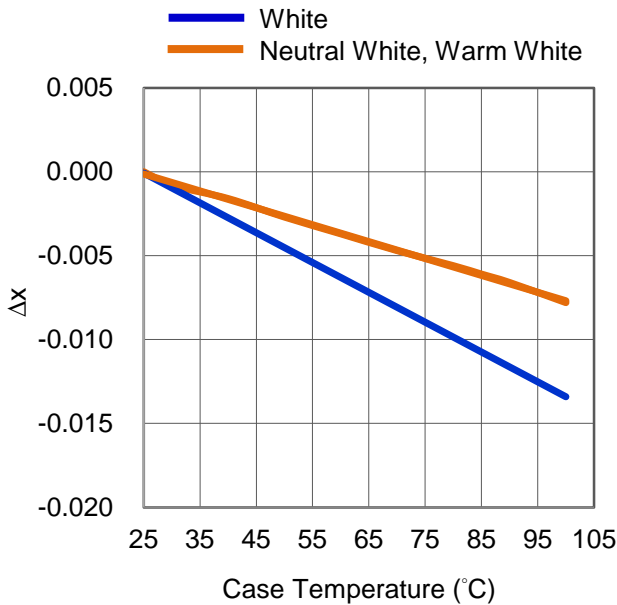

Fig 3. Case Temperature vs. Chromaticity Coordinate Δx at 1440mA.

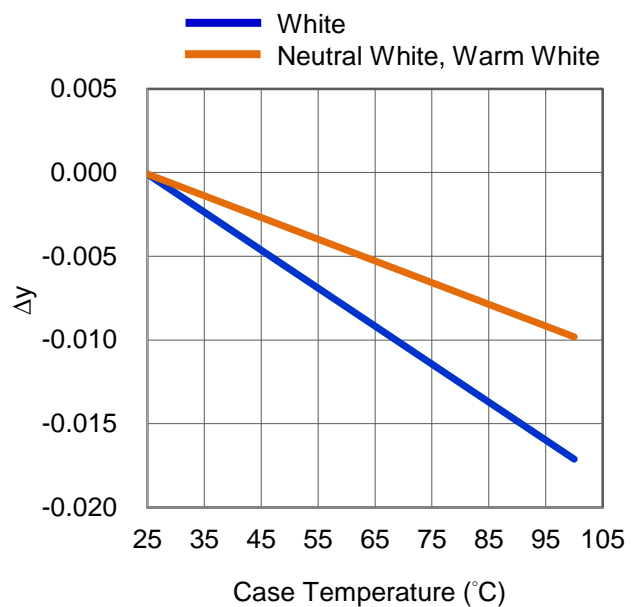

Fig 4. Case Temperature vs. Chromaticity Coordinate Δy at 1440mA.

Forward Current Relative Characteristics

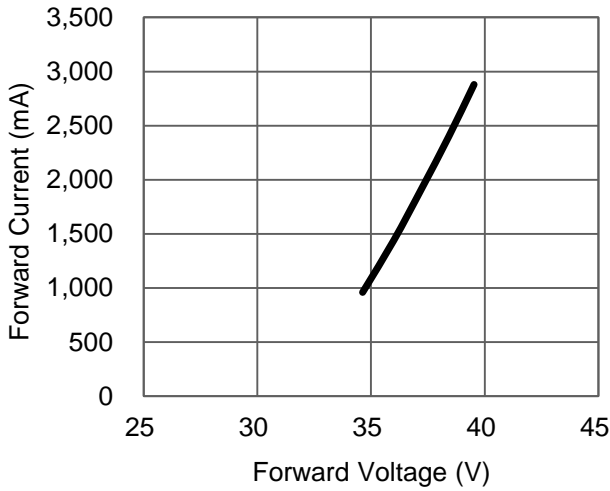

Fig 5. Forward Current vs. Forward Voltage at $T_C=25^\circ\text{C}$.

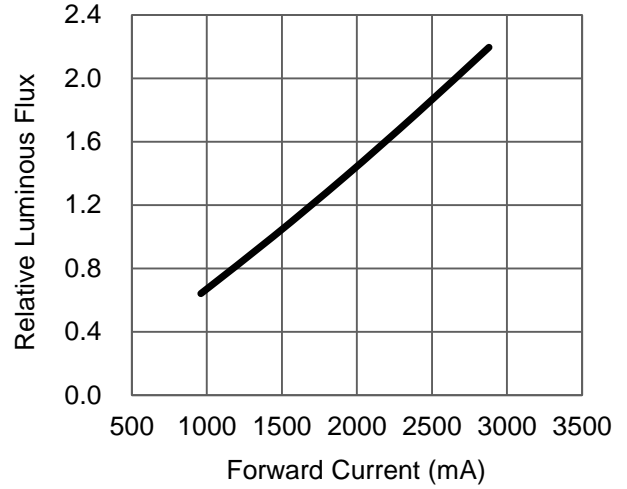

Fig 6. Forward Current vs. Relative Luminous Flux at $T_C=25^\circ\text{C}$.

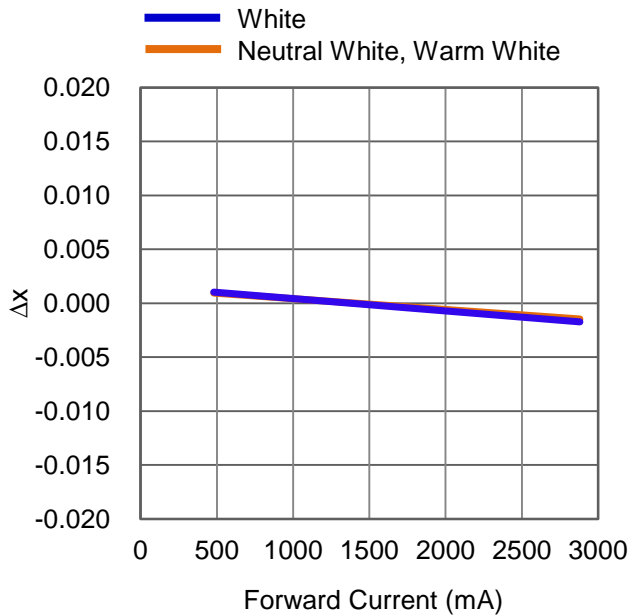

Fig 7. Forward Current vs. Chromaticity Coordinate Δx at $T_C=25^\circ\text{C}$.

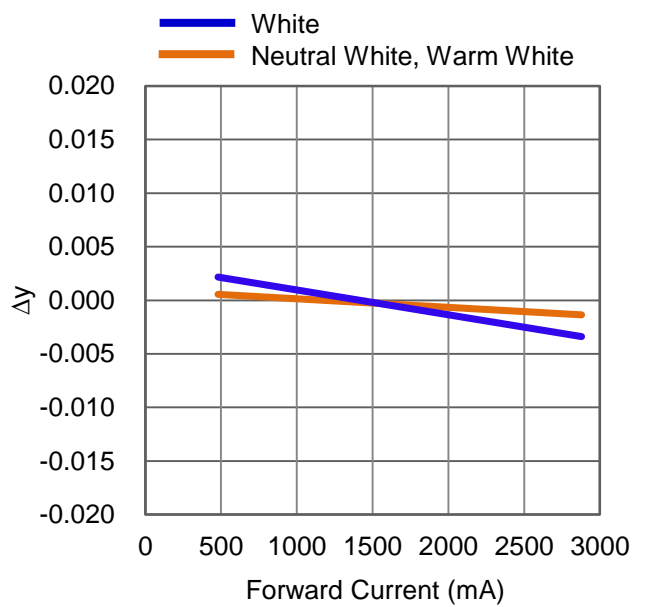

Fig 8. Forward Current vs. Chromaticity Coordinate Δy at $T_C=25^\circ\text{C}$.

Case Temperature vs. Junction Temperature Characteristics

T _c (°C)	T _j (°C)	
	1440 (mA)	2880 (mA)
0	20	45
10	30	55
20	40	65
30	50	75
40	60	85
50	70	95
60	80	105
70	90	115
80	100	125
90	110	-

Fig 9. Case Temperature vs. Junction Temperature at 1440 · 2880mA.

Color Coordinate vs. Forward Current, $T_c = 25^\circ\text{C}$

White Binning Graphical Representation

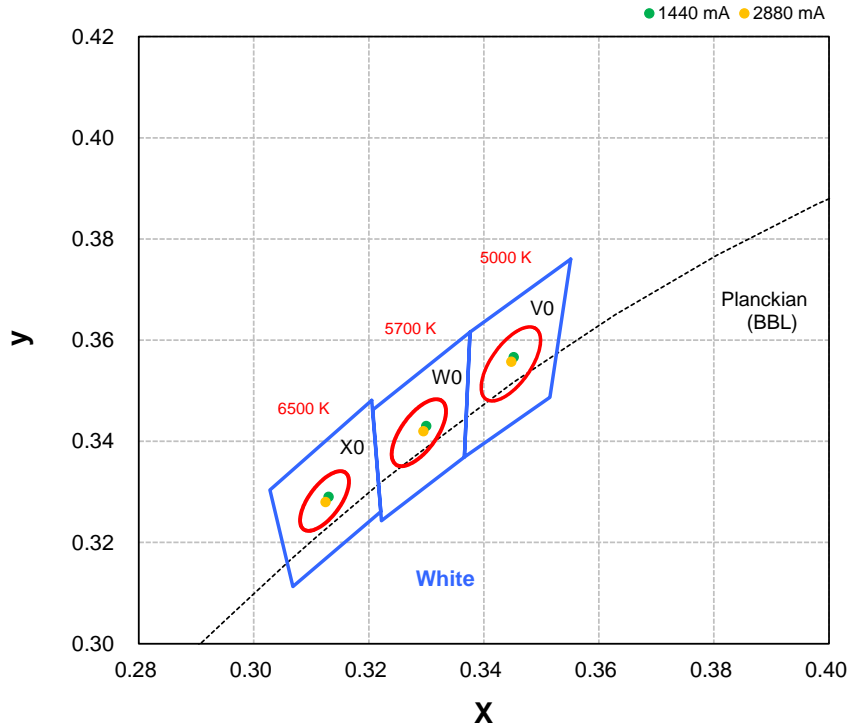

Neutral White Binning Graphical Representation

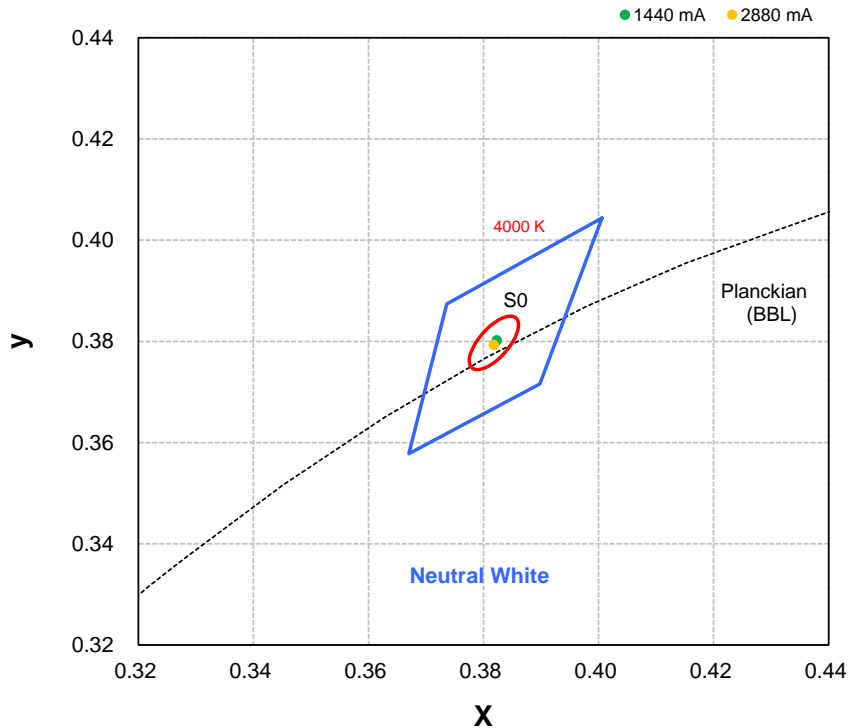

Color Coordinate vs. Forward Current, $T_c = 25^\circ\text{C}$

Warm White Binning Graphical Representation

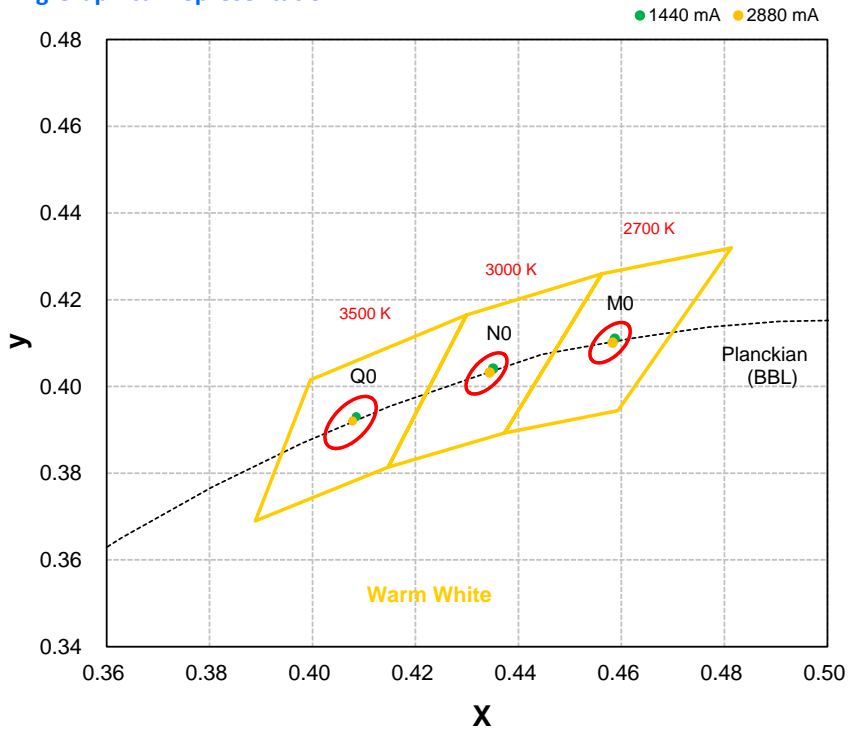

Typical Representative Spatial Radiation Pattern

Lambertian Radiation Pattern

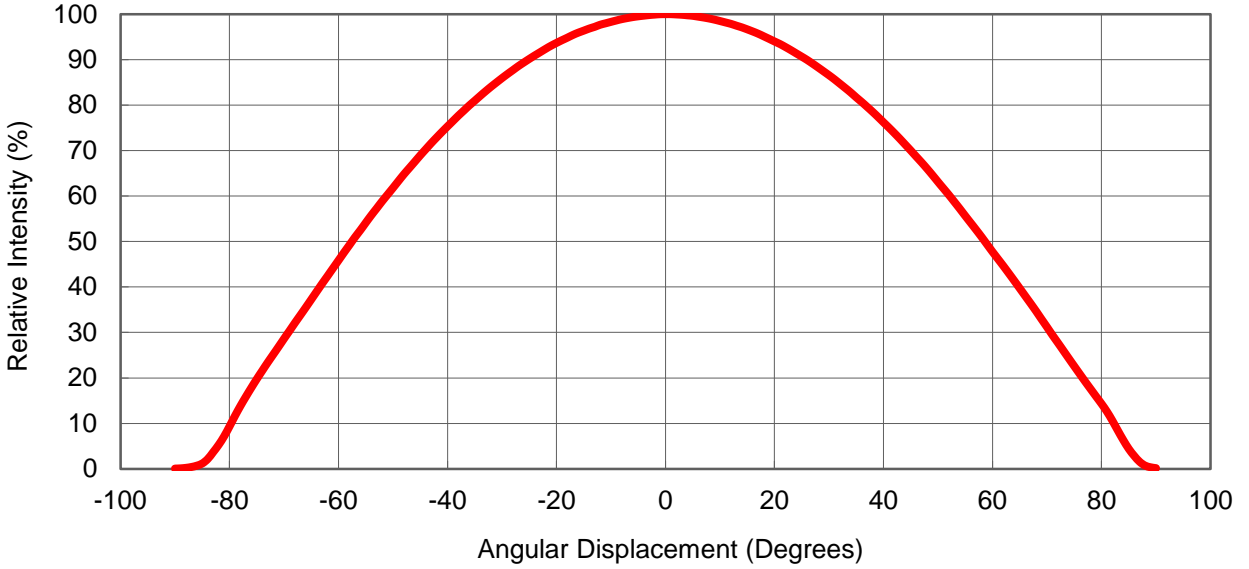

Polar Radiation Pattern

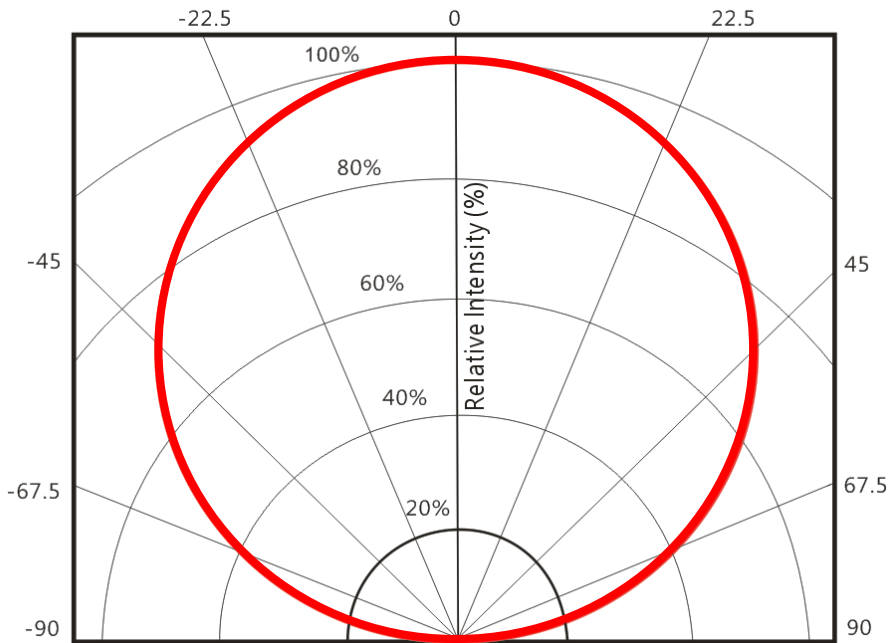

Packing Specifications

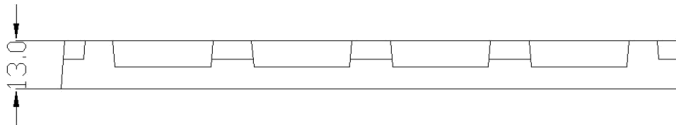
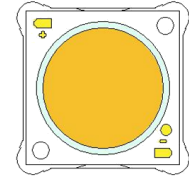
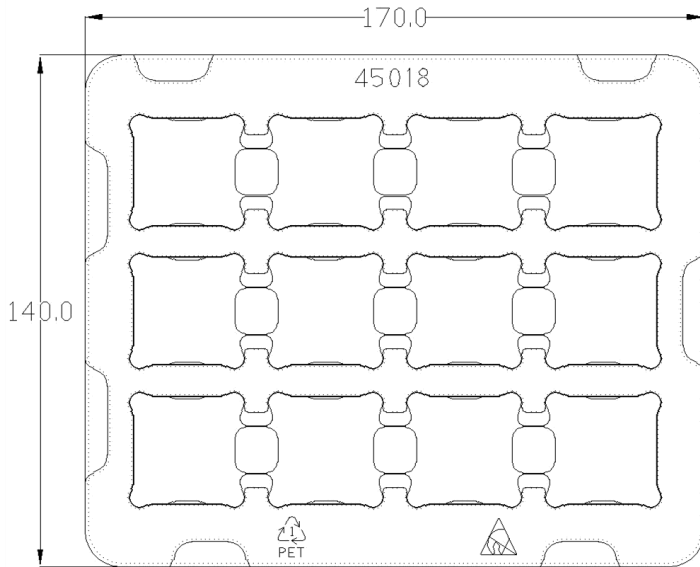

Product 12 pcs/tray

Notes:

1. Drawing not to scale.
2. All dimensions are in millimeters.
3. Unless otherwise indicated, tolerances are $\pm 0.20\text{mm}$.

Assembly note

Regarding the high power density of LED Array, it is strongly recommend to use thermal grease and screws.

In order to reduce thermal resistance at assembly, it is necessary to use TIM (thermal interface Material) uniformly and tighten screws on heatsink, otherwise the bad thermal resistance may cause the packages **burned out**.

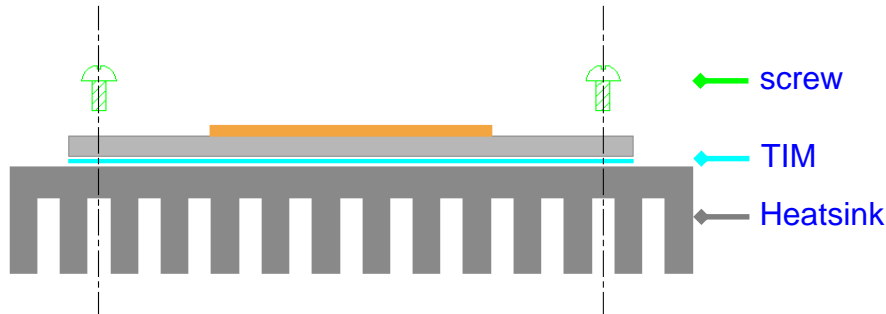

Fig 10. Reference assembly as fixing with screws

Limited Warranty : COB Light Engine Series

This limited warranty is provided by ProLight Opto described below (“Seller”) to you as the original purchaser of the LED lighting product that is identified on Seller’s invoice reflecting its original purchase (the “Product”). We warrant the identification as such on the invoice, will be free of defects in material and workmanship for a period of five (5) YEARS from the date of original purchase. This limited warranty excludes field labor and service charges related to the repair or replacement of the Product. Seller’s aggregate liability with respect to a defective product shall in any event be limited to the monies paid to seller for that defective product. The determination of whether the Product is defective shall be made by Seller in its sole discretion with consideration given to the overall performance of the Product. This limited warranty cannot be transferred to subsequent purchasers of the Product, provided that such Product is resold in new condition and in its original packaging. This limited warranty is void if the product is not used for the purpose for which it is designed.

Recommended Soldering Condition

- Please use lead free and “no clean ” solders.
- Soldering shall be implemented using a soldering tip at a temperature lower than 350 °C, and shall be finished within 3.5 seconds for each pad.
- During the soldering process, put the LEDs on materials whose conductivity is poor enough not to radiate heat of soldering.
- Properly solder tin wires before soldering them to LEDs.
- Avoid touching the silicone lens with the soldering iron.
- Please prevent flux from touching to the silicone lens.
- Please solder evenly on each pad.
- Contacts number of a soldering tip should be within twice for each pad.
- Next process of soldering should be carried out after the LEDs have return to ambient temperature.

*ProLight cannot guarantee if usage exceeds these recommended conditions.

Please use it after sufficient verification is carried out on your own risk if absolutely necessary.

Precaution for Use

- The modules light output are intense enough to cause injury to human eyes if viewed directly. Precautions must be taken to avoid looking directly at the modules with unprotected eyes.
- The modules are sensitive to electrostatic discharge. Appropriate ESD protection measures must be taken when working with the modules. Non-compliance with ESD protection measures may lead to damage or destruction of the product.
- Chemical solvents or cleaning agents must not be used to clean the modules. Mechanical stress on the Emitters must be avoided. It is best to use a soft brush, damp cloth or low-pressure compressed air.
- The products should be stored away from direct light in dry location.
- The appearance, specifications and flux bin of the product may be modified for improvement without notice. Please refer to the below website for the latest datasheets.
<http://www.prolightopto.com/>

Handling of Silicone Lens LEDs

Notes for handling of silicone lens LEDs

- Please do not use a force of over 0.3kgf impact or pressure on the silicone lens, otherwise it will cause a catastrophic failure.
- Avoid touching the silicone lens and the optical area of the COB Array especially by sharp tools such as Tweezers
- Avoid touching the silicone lens especially by sharp tools such as Tweezers.
- Avoid leaving fingerprints on the silicone lens.
- Please store the LEDs away from dusty areas or seal the product against dust.
- Please do not mold over the silicone lens with another resin. (epoxy, urethane, etc)

