

ProLight PACE-28FxL-xC4P
28W COB Light-Engine LEDs
Technical Datasheet
Version: 1.4

ProLight Opto ® ProEngine Series

Features

- High flux density of lighting source
- Good color uniformity
- RoHS compliant
- Energy Star binning structure, neutral white and warm white with 2 steps guarantee.
- More energy efficient than incandescent and most halogen lamps
- No UV
- Long lifetime
- 5 year warranty

Main Applications

- Par lighting
- LED Bulb
- Ceiling lighting
- Spot lighting
- Down lighting

Introduction

·The input power is 28 Watt, the multi-chip ultra high power ProEngine Series delivers never before seen luminous flux output from a single emitter. The superficial illuminating nature of ProEngine makes them the preference in Par lighting, typical applications include commercial down lighting, LED bulb, accent lighting, ceiling lighting and spot lighting.

Emitter Mechanical Dimensions

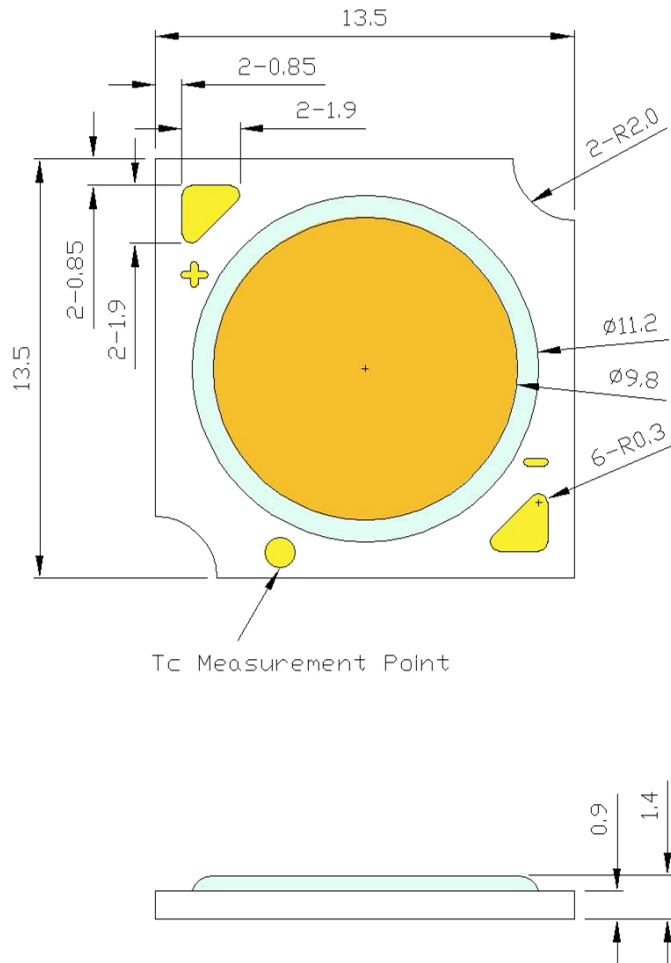

Notes:

1. Slots in aluminum-core PCB for M3 mounting screw.
2. Solder pads are labeled "+" and "-" to denote positive and negative, respectively.
3. Drawing not to scale.
4. All dimensions are in millimeters.
5. Unless otherwise indicated, tolerances are ± 0.30 mm.
6. **Please do not use a force of over 0.3kgf impact or pressure on the lens of the LED, otherwise it will cause a catastrophic failure.**

*The appearance and specifications of the product may be modified for improvement without notice.

Flux Characteristics, $T_c = 25^\circ\text{C}$

Radiation Pattern	Color	Part Number COB	DC Forward Current (mA)		Luminous Flux Φ_v (lm)		CRI Minimum
			Minimum	Typical	Minimum	Typical	
Lambertian	White	PACE-28FWL-BC4P	360*	1710	1910	80	
			720	3040	3380		
	Neutral White	PACE-28FNL-BC4P	360*	1680	1880	80	
			720	2980	3330		
	Warm White	PACE-28FVL-BC4P	360*	1530	1790	80	
			720	2720	3170		
		PACE-28FVL-DC4P	360*	1300	1520	90	
			720	2310	2700		

- The mark "*" indicated product is tested and binned at the specified drive current.
- ProLight maintains a tolerance of $\pm 7\%$ on flux and power measurements.
- ProLight maintains a tolerance of ± 2 on CRI measurements.
- Please do not drive at rated current more than 1 second without proper heat sink.

Electrical Characteristics at 360mA, $T_c = 25^\circ\text{C}$

Color	Forward Voltage V_F (V)			Thermal Resistance Junction to Board ($^\circ\text{C}/\text{W}$)
	Min.	Typ.	Max.	
White	33.7	36.0	38.3	1.4
Neutral White	33.7	36.0	38.3	1.4
Warm White	33.7	36.0	38.3	1.4

- ProLight maintains a tolerance of $\pm 1\text{V}$ for Voltage measurements.

Optical Characteristics at 360mA, $T_c = 25^\circ\text{C}$

Color	Bin Code	Color Temperature CCT			Total included Angle (degrees) $\theta_{0.90V}$	Viewing Angle (degrees) $2\theta_{1/2}$
		Min.	Typ.	Max.		
White	V0	4740 K	5000 K	5310 K	160	120
	W0	5310 K	5700 K	6010 K	160	120
Neutral White	S0	3900 K	4000 K	4070 K	160	120
	M0	2670 K	2700 K	2770 K	160	120
Warm White	NC	2890 K	2940 K	2990 K	160	120
	N0	2990 K	3000 K	3090 K	160	120

- ProLight maintains a tolerance of $\pm 5\%$ for CCT measurements.

Electro-Optical Characteristics, $T_c = 25^\circ\text{C}$

I_F (mA)	V_F (V)	Power (W)	PACE-28FWL-BC4P		PACE-28FNL-BC4P	
			Flux (lm)	lm/W	Flux (lm)	lm/W
240	34.63	8.31	1329	159.9	1308	157.4
360*	36.00	12.96	1910	147.4	1880	145.1
480	37.23	17.87	2440	136.5	2402	134.4
600	38.42	23.05	2937	127.4	2890	125.4
720	39.53	28.46	3385	118.9	3332	117.1

I_F (mA)	V_F (V)	Power (W)	PACE-28FVL-BC4P		PACE-28FVL-DC4P	
			Flux (lm)	lm/W	Flux (lm)	lm/W
240	34.63	8.31	1246	149.9	1058	127.3
360*	36.00	12.96	1790	138.1	1520	117.3
480	37.23	17.87	2287	128.0	1942	108.7
600	38.42	23.05	2752	119.4	2337	101.4
720	39.53	28.46	3172	111.5	2694	94.7

● All values are reference only.

Absolute Maximum Ratings

Parameter	White/Neutral White/Warm White
Max DC Forward Current (mA)	720
Peak Pulsed Forward Current (mA)	1080 (less than 1/10 duty cycle@1KHz)
ESD Sensitivity (HBM per MIL-STD-883E Method 3015.7)	$\pm 2000\text{V}$
LED Junction Temperature	120°C
Operating Board Temperature at Maximum DC Forward Current	$-40^\circ\text{C} - 90^\circ\text{C}$
Storage Temperature	$-40^\circ\text{C} - 120^\circ\text{C}$
Reverse Voltage	Not designed to be driven in reverse bias

Color Bin

White Binning Structure Graphical Representation

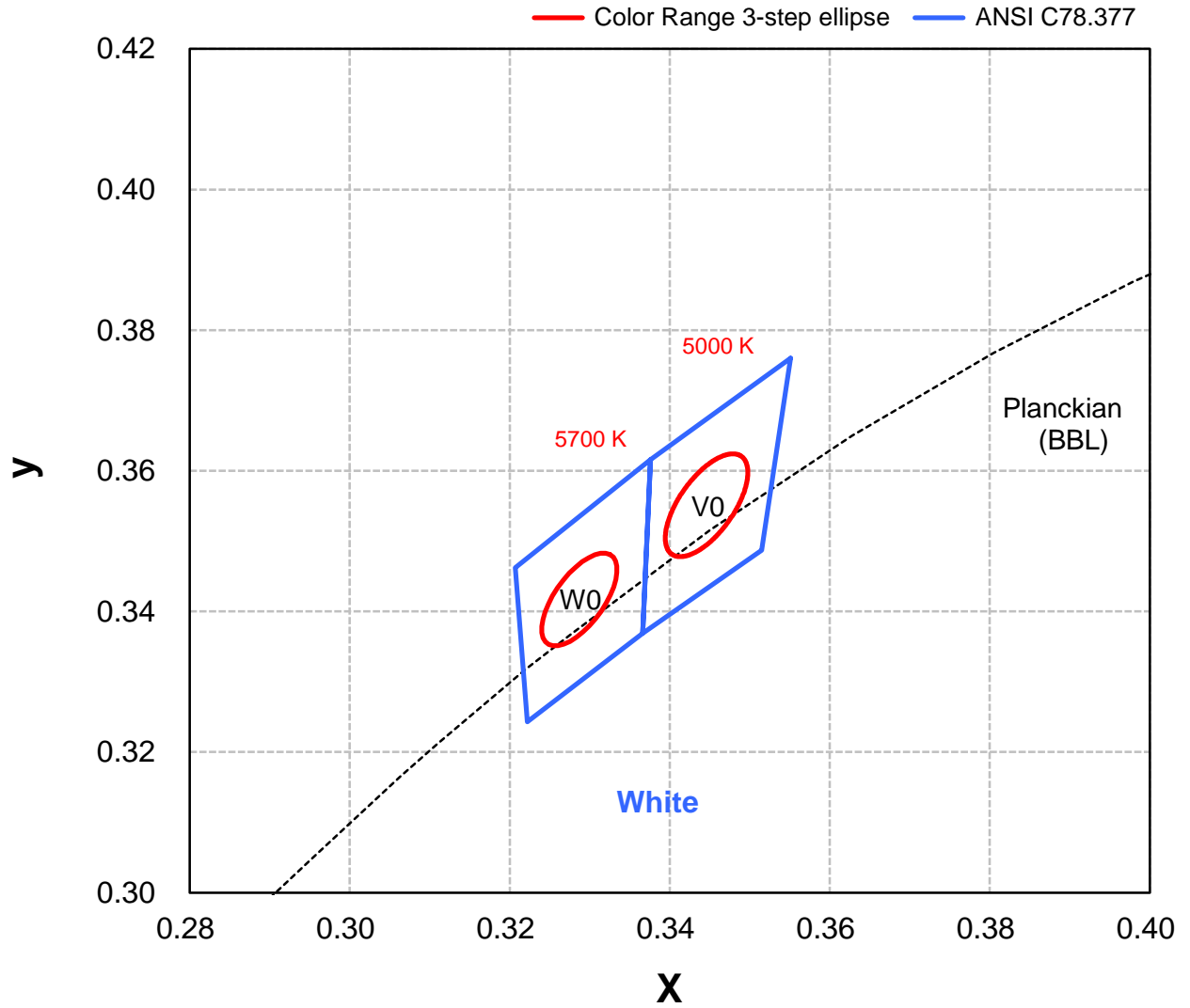

White Bin Structure

Bin Code	Center	Oval parameter	Typ. CCT (K)	Bin Code	Center	Oval parameter	Typ. CCT (K)
V0	x	a 0.00822	5000	W0	x	a 0.00745	5700
	y	b 0.00354			y	b 0.00320	
	e° 59.62	y			e° 59.09		

- Color range stay within MacAdam "3-step" ellipse from the chromaticity center.
- The chromaticity center refers to ANSI C78.377.
- Tolerance on each color bin (x , y) is ± 0.005

Color Bin

Neutral White Binning Structure Graphical Representation

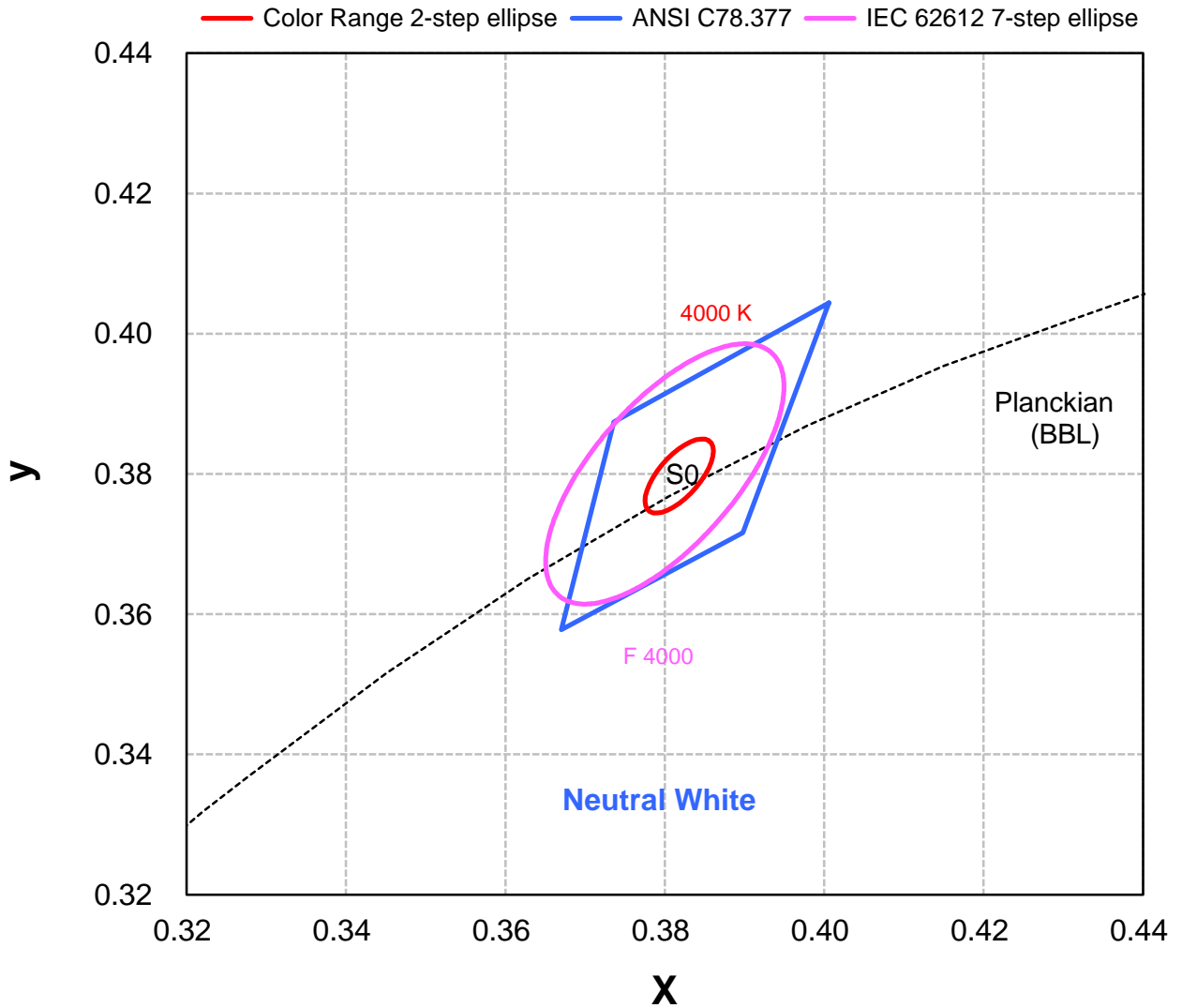

Neutral White Bin Structure

Bin Code	Center	Oval parameter	Typ. CCT (K)
S0	x	0.3818	4000
	y	0.3797	
	a	0.00626	
	b	0.00268	
		e°	53.72

- Color range stay within MacAdam "2-step" ellipse from the chromaticity center.
- The chromaticity center refers to ANSI C78.377.
- Tolerance on each color bin (x , y) is ± 0.005

Color Bin

Warm White Binning Structure Graphical Representation

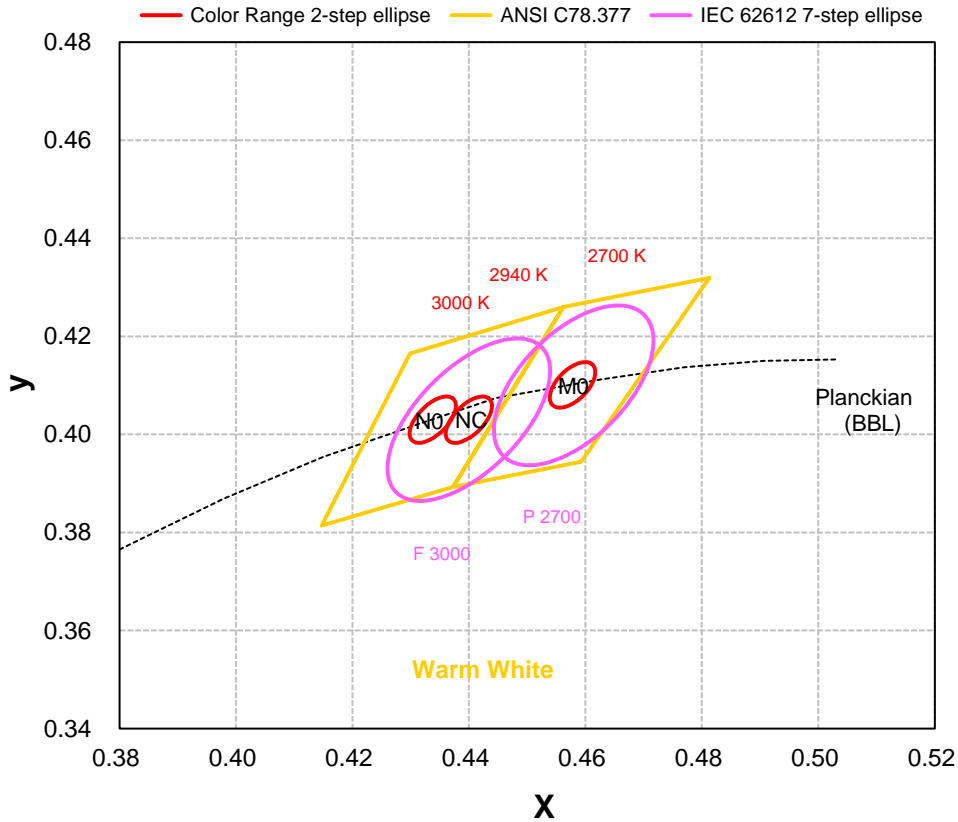

Warm White Bin Structure

Bin Code	Center	Oval parameter	Typ. CCT (K)	Bin Code	Center	Oval parameter	Typ. CCT (K)
M0	x 0.4578 y 0.4101	a 0.0054 b 0.0028 e° 53.70	2700	N0	x 0.4338 y 0.4030	a 0.00556 b 0.00272 e° 53.22	3000

- Color range stay within MacAdam “2-step” ellipse from the chromaticity center.
- The chromaticity center refers to ANSI C78.377.
- Tolerance on each color bin (x , y) is ± 0.005

Bin Code	Center	Oval parameter	Typ. CCT (K)
NC	x 0.4400 y 0.4030	a 0.00556 b 0.00272 e° 53.02	2940

- Color range stay within MacAdam “2-step” ellipse from the chromaticity center.
- The chromaticity center refers to IEC 62612.
- Tolerance on each color bin (x , y) is ± 0.005

Color Spectrum, $T_c = 25^\circ\text{C}$

1. White

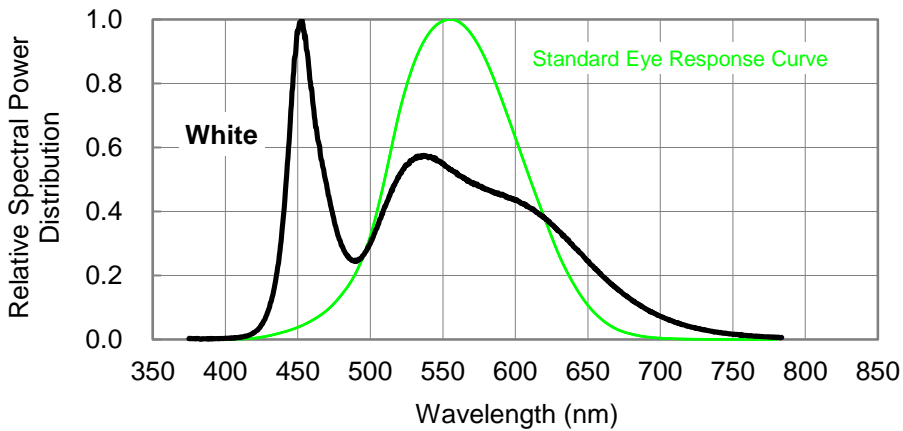

2. Neutral White

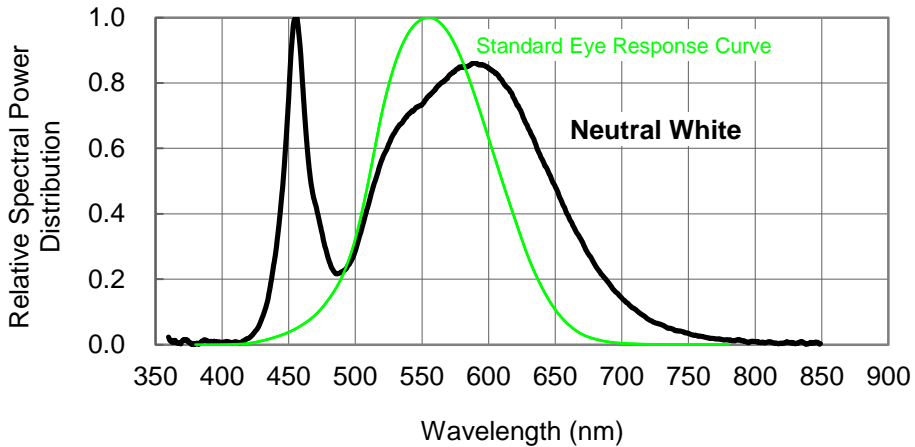

3. Warm White

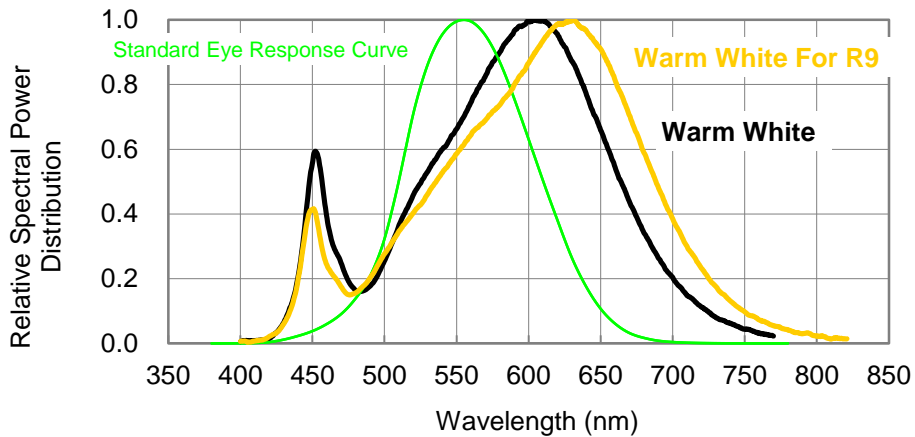

Case Temperature Relative Characteristics

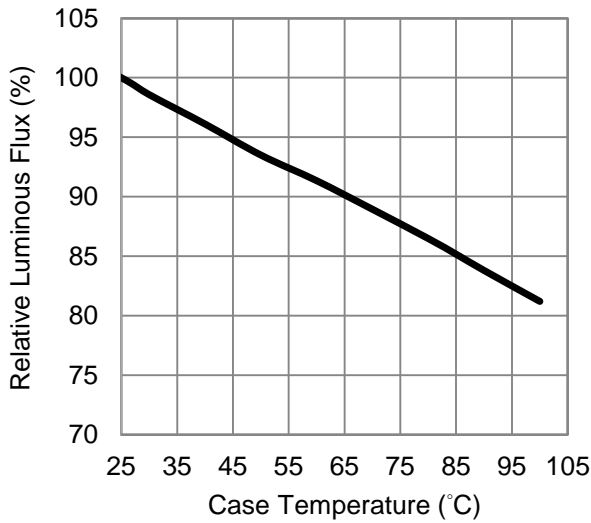

Fig 1. Case Temperature vs. Relative Luminous Flux at 360mA.

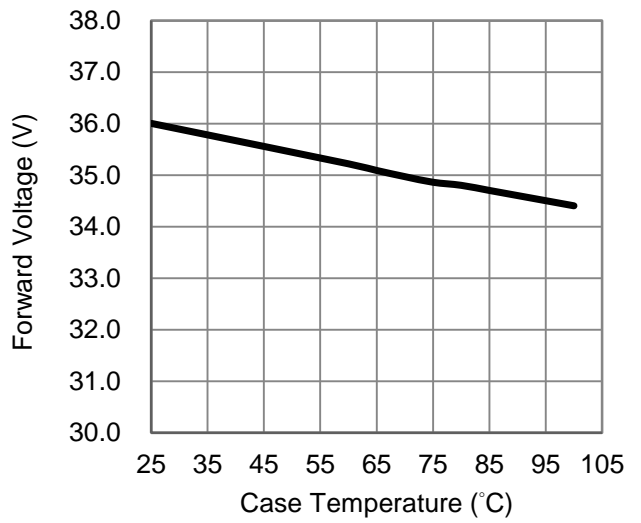

Fig 2. Case Temperature vs. Forward Voltage at 360mA.

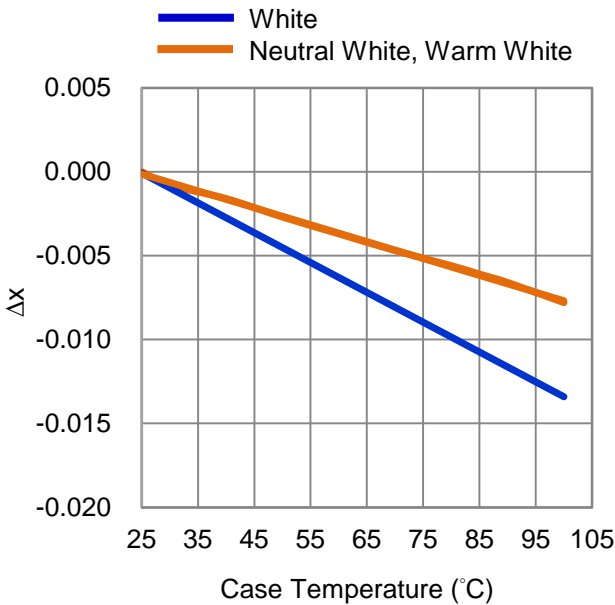

Fig 3. Case Temperature vs. Chromaticity Coordinate Δx at 360mA.

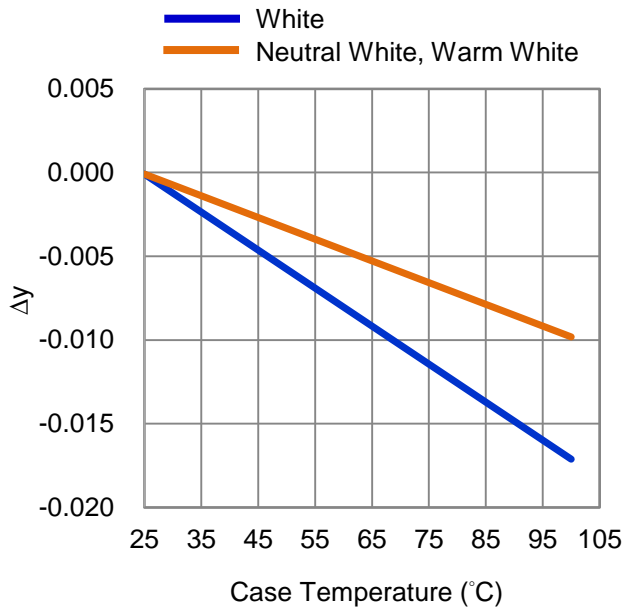

Fig 4. Case Temperature vs. Chromaticity Coordinate Δy at 360mA.

Forward Current Relative Characteristics

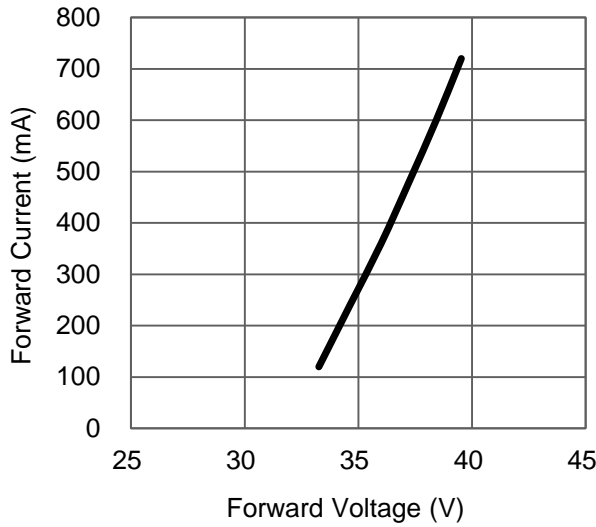

Fig 5. Forward Current vs. Forward Voltage at $T_C=25^\circ\text{C}$.

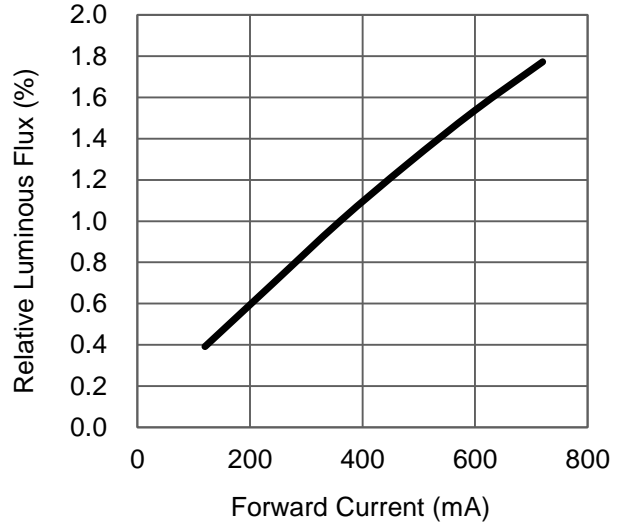

Fig 6. Forward Current vs. Relative Luminous Flux at $T_C=25^\circ\text{C}$.

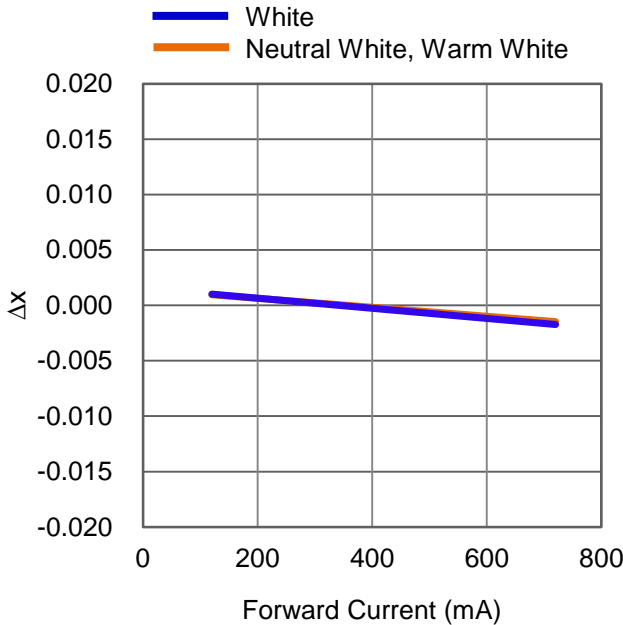

Fig 7. Forward Current vs. Chromaticity Coordinate Δx at $T_C=25^\circ\text{C}$.

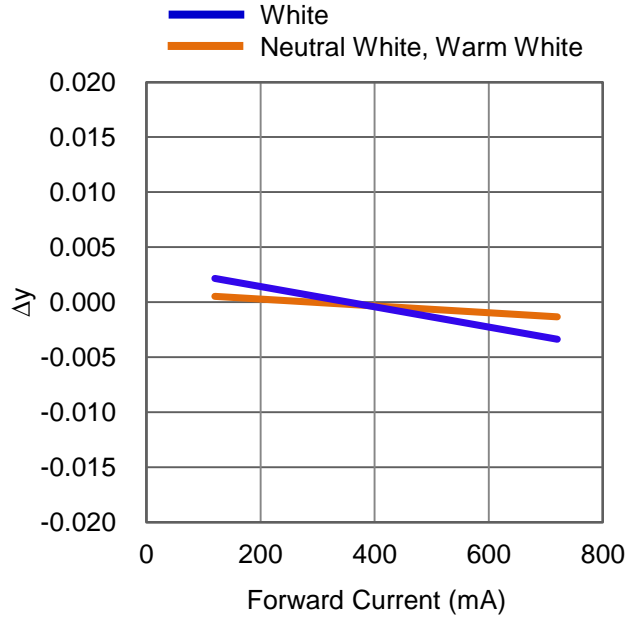

Fig 8. Forward Current vs. Chromaticity Coordinate Δy at $T_C=25^\circ\text{C}$.

Case Temperature vs. Junction Temperature Characteristics

T _c (°C)	T _j (°C)	
	360 (mA)	720 (mA)
0	18	40
5	23	45
10	28	50
15	33	55
20	38	60
25	43	65
30	48	70
35	53	75
40	58	80
45	63	85
50	68	90
55	73	95
60	78	100
65	83	105
70	88	110
75	93	115
80	98	120

Fig 9. Case Temperature vs. Junction Temperature at 360 ~ 720mA.

Color Coordinate vs. Forward Current, $T_c = 25^\circ\text{C}$

White Binning Graphical Representation

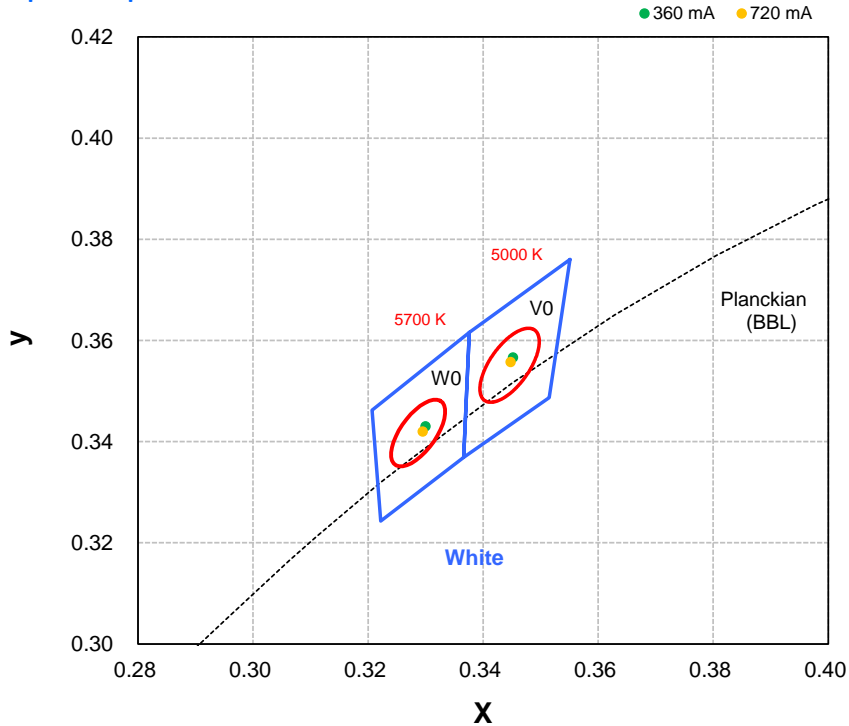

Neutral White Binning Graphical Representation

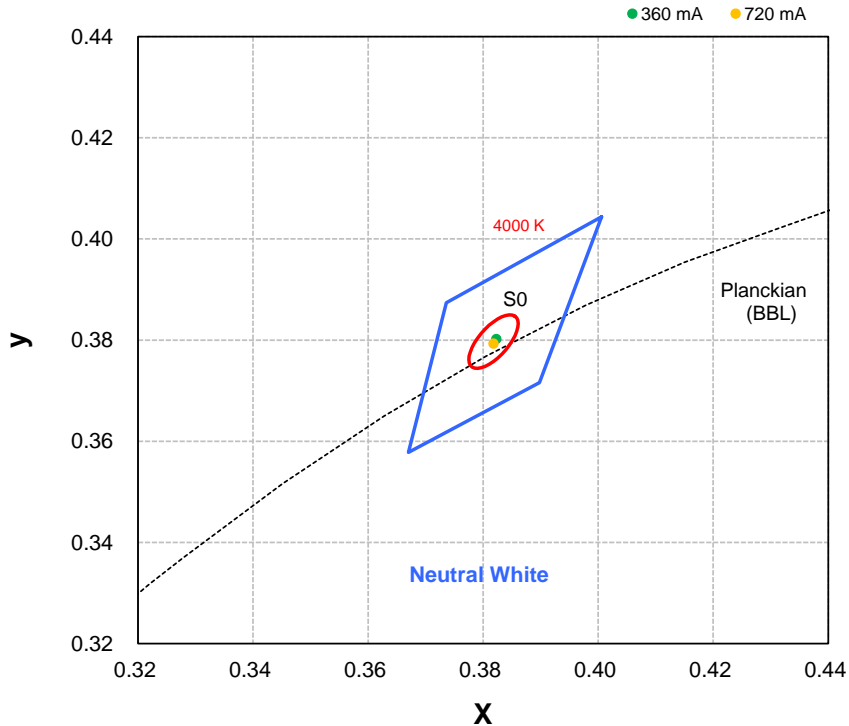

Color Coordinate vs. Forward Current, $T_c = 25^\circ\text{C}$

Warm White Binning Graphical Representation

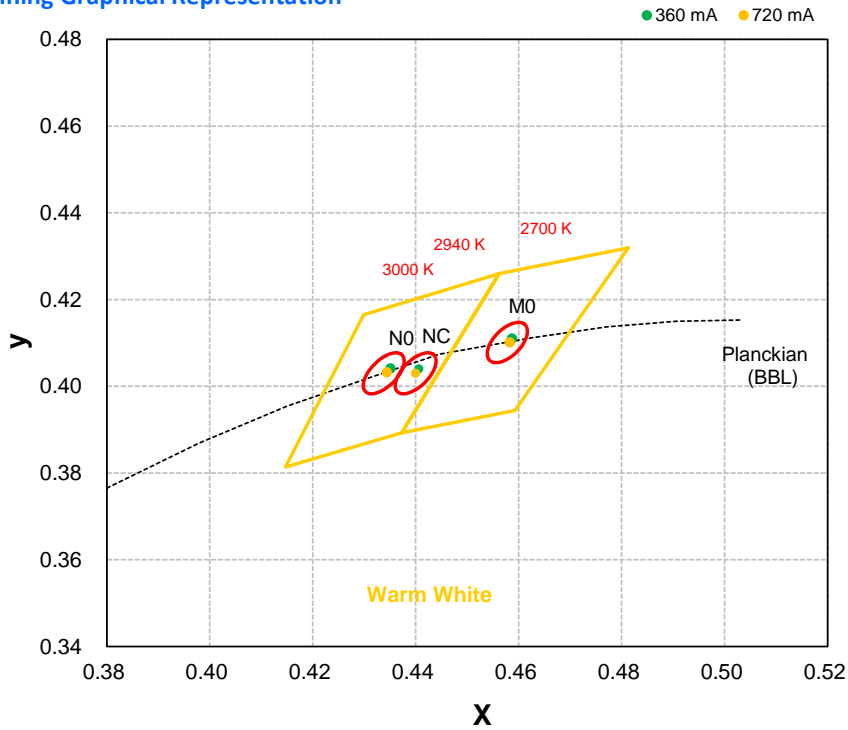

Typical Representative Spatial Radiation Pattern

Lambertian Radiation Pattern

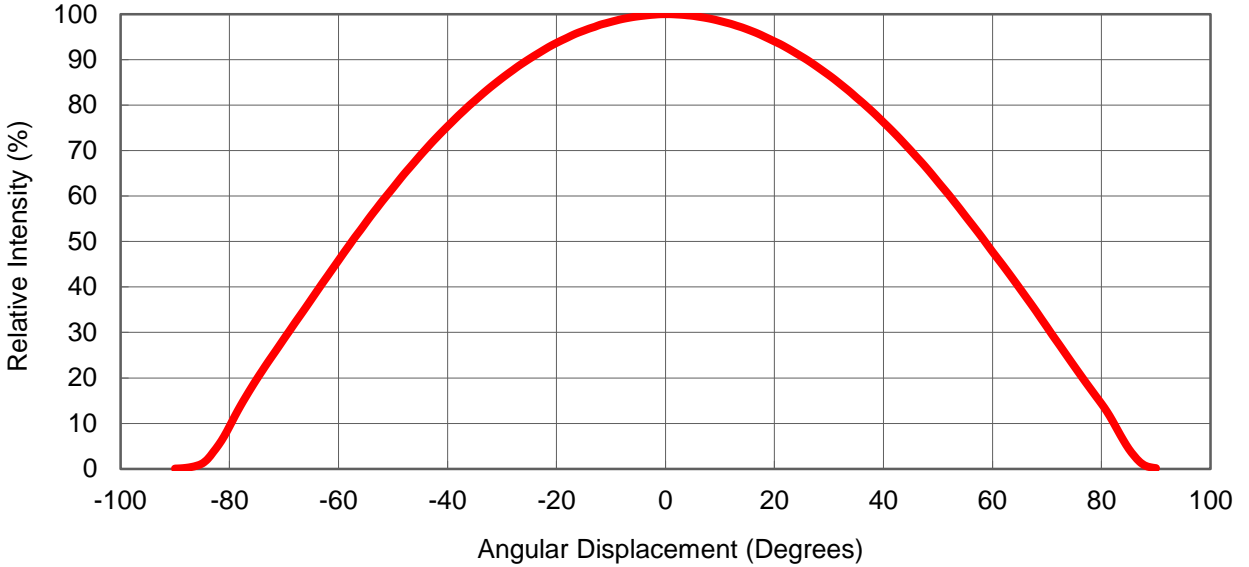

Polar Radiation Pattern

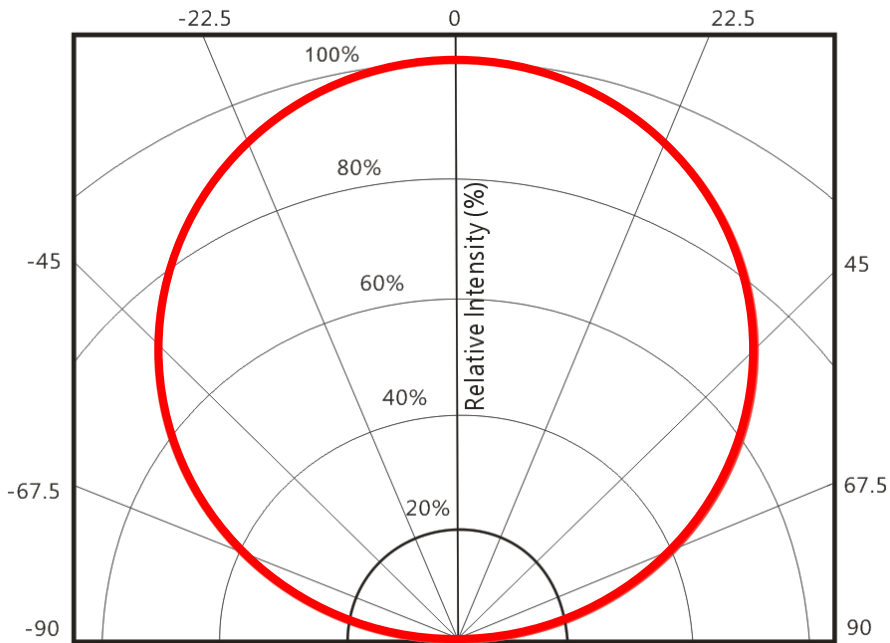

Packing Specifications

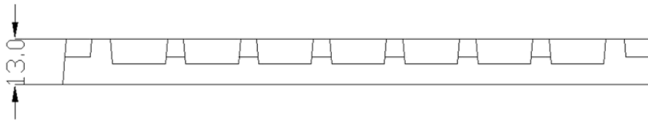
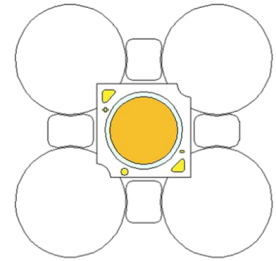
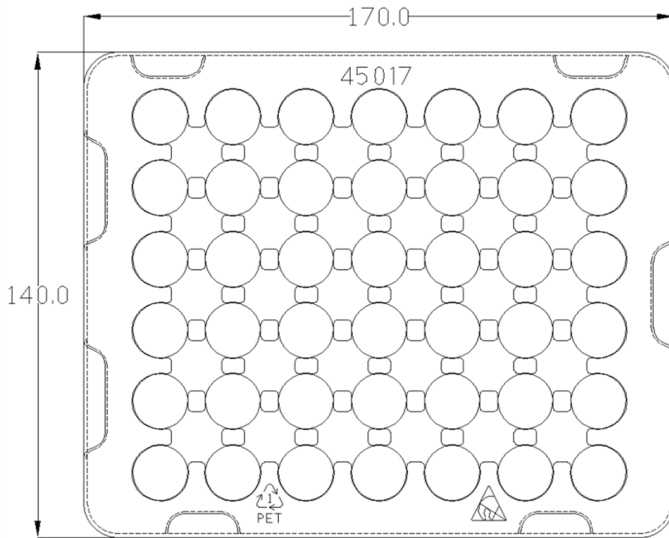

Product 30 pcs/tray

Notes:

1. Drawing not to scale.
2. All dimensions are in millimeters.
3. Unless otherwise indicated, tolerances are $\pm 0.20\text{mm}$.

Assembly note

Regarding the high power density of LED Array, it is strongly recommend to use thermal grease and screws.

In order to reduce thermal resistance at assembly, it is necessary to use TIM (thermal interface Material) uniformly and tighten screws on heatsink, otherwise the bad thermal resistance may cause the packages **burned out**.

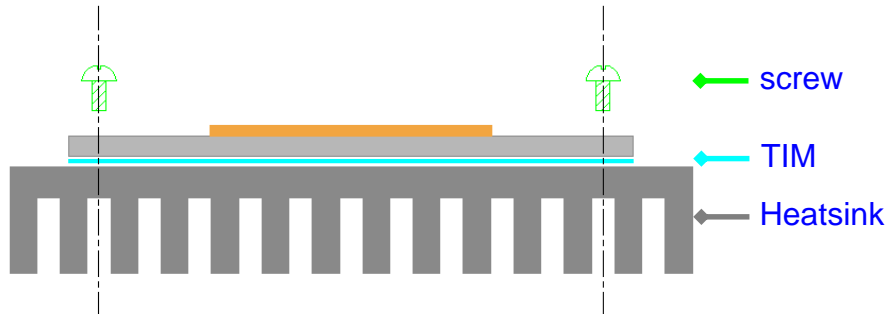

Fig 10. Reference assembly as fixing with screws

Limited Warranty : COB Light Engine Series

This limited warranty is provided by ProLight Opto described below (“Seller”) to you as the original purchaser of the LED lighting product that is identified on Seller’s invoice reflecting its original purchase (the “Product”). We warrant the identification as such on the invoice, will be free of defects in material and workmanship for a period of five (5) YEARS from the date of original purchase. This limited warranty excludes field labor and service charges related to the repair or replacement of the Product. Seller’s aggregate liability with respect to a defective product shall in any event be limited to the monies paid to seller for that defective product. The determination of whether the Product is defective shall be made by Seller in its sole discretion with consideration given to the overall performance of the Product. This limited warranty cannot be transferred to subsequent purchasers of the Product, provided that such Product is resold in new condition and in its original packaging. This limited warranty is void if the product is not used for the purpose for which it is designed.

Recommended Soldering Condition

- Please use lead free and “no clean ” solders.
- Soldering shall be implemented using a soldering tip at a temperature lower than 350 °C, and shall be finished within 3.5 seconds for each pad.
- During the soldering process, put the LEDs on materials whose conductivity is poor enough not to radiate heat of soldering.
- Properly solder tin wires before soldering them to LEDs.
- Avoid touching the silicone lens with the soldering iron.
- Please prevent flux from touching to the silicone lens.
- Please solder evenly on each pad.
- Contacts number of a soldering tip should be within twice for each pad.
- Next process of soldering should be carried out after the LEDs have return to ambient temperature.

*ProLight cannot guarantee if usage exceeds these recommended conditions.

Please use it after sufficient verification is carried out on your own risk if absolutely necessary.

Precaution for Use

- The modules light output are intense enough to cause injury to human eyes if viewed directly. Precautions must be taken to avoid looking directly at the modules with unprotected eyes.
- The modules are sensitive to electrostatic discharge. Appropriate ESD protection measures must be taken when working with the modules. Non-compliance with ESD protection measures may lead to damage or destruction of the product.
- Chemical solvents or cleaning agents must not be used to clean the modules. Mechanical stress on the Emitters must be avoided. It is best to use a soft brush, damp cloth or low-pressure compressed air.
- The products should be stored away from direct light in dry location.
- The appearance, specifications and flux bin of the product may be modified for improvement without notice. Please refer to the below website for the latest datasheets.
<http://www.prolightopto.com/>

Handling of Silicone Lens LEDs

Notes for handling of silicone lens LEDs

- Please do not use a force of over 0.3kgf impact or pressure on the silicone lens, otherwise it will cause a catastrophic failure.
- Avoid touching the silicone lens and the optical area of the COB Array especially by sharp tools such as Tweezers
- Avoid touching the silicone lens especially by sharp tools such as Tweezers.
- Avoid leaving fingerprints on the silicone lens.
- Please store the LEDs away from dusty areas or seal the product against dust.
- Please do not mold over the silicone lens with another resin. (epoxy, urethane, etc)

