

■ **Features**

- High-power LED
- Long lifetime operation
- Typical viewing angle : 140deg
- RoHS compliant
- Possible to attach to heat sink directly without using print circuit board.

■ **Applications**

- Indoor & outdoor lighting
- Stage lighting
- Reading lamps
- Display cases, furniture illumination, marker
- Architectural illumination
- Spotlights

■ **Outline Dimension**

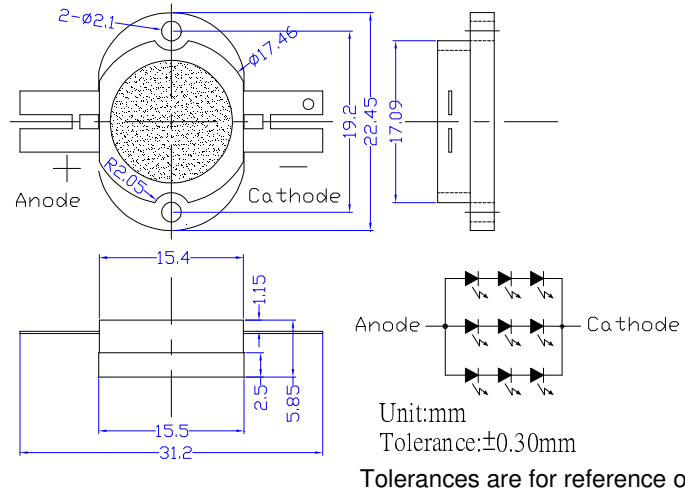

■ **Absolute Maximum Rating**

(Ta=25°C)

Item	Symbol	Value	Unit
DC Forward Current *1	I _F	600	mA
Pulse Forward Current*2	I _{FP}	1,000	mA
Reverse Voltage	V _R	15	V
Power Dissipation*1	P _D	6,840	mW
Operating Temperature	Topr	-30 ~ +85	°C
Storage Temperature	Tstg	-40~ +100	°C
Lead Soldering Temperature	Tsol	260°C /5sec	-

■ **Directivity**

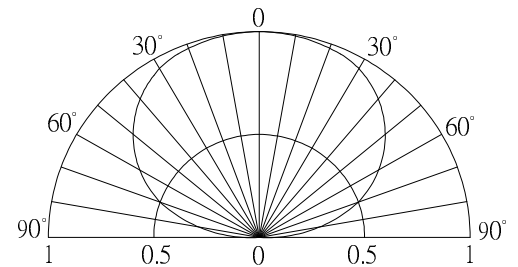

*1, Power dissipation and forward current are the value when the module temperature is set lower than the rating by using an adequate heat sink.

*2, Pulse width Max.10ms Duty ratio max 1/10

■ **Electrical -Optical Characteristics**

(Ta=25°C)

Item	Symbol	Condition	Min.	Typ.	Max.	Unit
DC Forward Voltage	V _F	I _F =500mA	8.7	10	11.4	V
DC Reverse Current	I _R	V _R =15V	-	-	30	μA
Luminous Flux	Φ _v	I _F =500mA	350	410	-	lm
Color Temperature	CCT	I _F =500mA	-	6500	-	K
Chromaticity Coordinates*	x	I _F =500mA	-	0.31	-	
	y	I _F =500mA	-	0.34	-	
50% Power Angle	2θ _{1/2}	I _F =500mA	-	140	-	deg

Note: Don't drive at rated current more than 5s without heat sink for High Power series.

* Tolerance of chromaticity coordinates is ±10% , * Tolerance of Luminous Flux is ±20%

■Heat design

The following pictures show some measurements of mounted 5W Led on the heat sink for each board A and B (See Fig 1) with using thermograph to make an observation about heat distribution. Each boards is tested at various current conditions.

As a result, LED needs larger heat sink as much as possible to reduce its own case temperature.

Fig. 1 Configuration pattern examples for board assembly

Board	LED power	Material	Surface area (mm ²)	Min.
A	5W	Al	10,300	
B	10W	Al	20,600	
C	25W	Al	51,500	
D	50W	Al	103,000	
E	100W	Al	206,000	
F	200W	Al	412,000	
G	300W	Al	618,000	

Above tested LED device is attached with adhesive sheet to the heatsink.

For reference's sake, Tj absolute maximum rating is defined at 115°C as a prerequisite on design process of 5W LED.

<Fig.2> Board A (surface area=10,300mm²)

<Fig.3> Board B (surface area=20,600mm²)

IF=200mA

IF=200mA

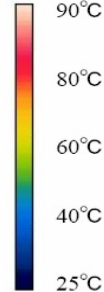
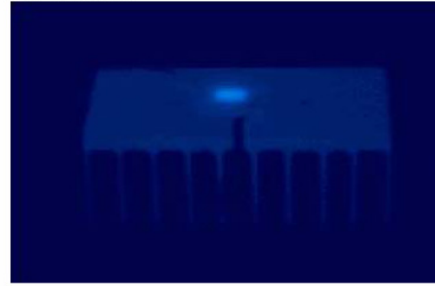
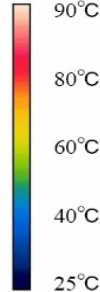
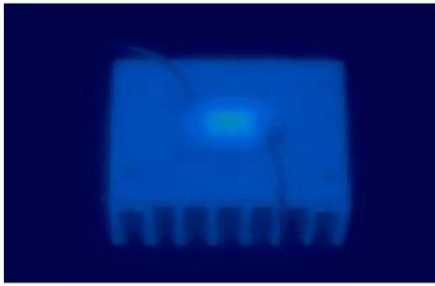

IF=400mA

IF=400mA

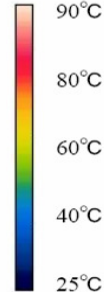
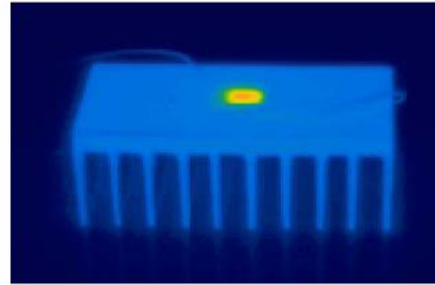
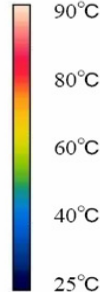
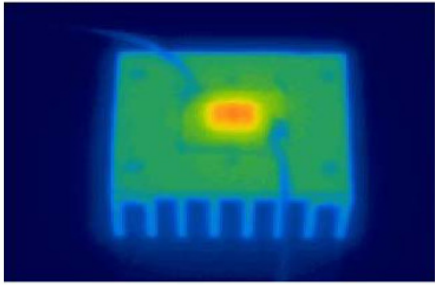

IF=600mA

IF=600mA

