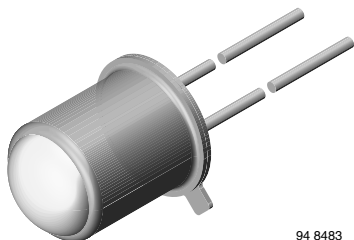


Infrared Emitting Diode, RoHS Compliant, 950 nm, GaAs



94 8483

DESCRIPTION

TSTS7100 is an infrared, 950 nm emitting diode in GaAs technology in a hermetically sealed TO-18 package with lens.

FEATURES

- Package type: leaded
- Package form: TO-18
- Dimensions (in mm): \varnothing 4.7
- Peak wavelength: $\lambda_p = 950$ nm
- High reliability
- High radiant power
- High radiant intensity
- Angle of half intensity: $\varphi = \pm 5^\circ$
- Low forward voltage
- Suitable for high pulse current operation
- Good spectral matching with Si photodetectors
- Lead (Pb)-free component in accordance with RoHS 2002/95/EC and WEEE 2002/96/EC



RoHS
COMPLIANT

APPLICATIONS

- Radiation source in near infrared range

PRODUCT SUMMARY

| COMPONENT | I_e (mW/sr) | φ (deg) | λ_p (nm) | t_r (ns) |
|-----------|---------------|-----------------|------------------|------------|
| TSTS7100 | > 10 | ± 5 | 950 | 800 |

Note

Test conditions see table "Basic Characteristics"

ORDERING INFORMATION

| ORDERING CODE | PACKAGING | REMARKS | PACKAGE FORM |
|---------------|-----------|------------------------------|--------------|
| TSTS7100 | Bulk | MOQ: 1000 pcs, 1000 pcs/bulk | TO-18 |

Note

MOQ: minimum order quantity

ABSOLUTE MAXIMUM RATINGS

| PARAMETER | TEST CONDITION | SYMBOL | VALUE | UNIT |
|-------------------------------------|---|------------|---------------|------------------|
| Reverse voltage | | V_R | 5 | V |
| Forward current | $T_{case} \leq 25^\circ\text{C}$ | I_F | 250 | mA |
| Peak forward current | $t_p/T = 0.5, t_p \leq 100 \mu\text{s}, T_{case} \leq 25^\circ\text{C}$ | I_{FM} | 500 | mA |
| Surge forward current | $t_p \leq 100 \mu\text{s}$ | I_{FSM} | 2.5 | A |
| Power dissipation | | P_V | 170 | mW |
| | $T_{case} \leq 25^\circ\text{C}$ | P_V | 500 | mW |
| Junction temperature | | T_j | 100 | $^\circ\text{C}$ |
| Storage temperature range | | T_{stg} | - 55 to + 100 | $^\circ\text{C}$ |
| Thermal resistance junction/ambient | leads not soldered | R_{thJA} | 450 | K/W |
| Thermal resistance junction/case | leads not soldered | R_{thJC} | 150 | K/W |

Note

$T_{amb} = 25^\circ\text{C}$, unless otherwise specified

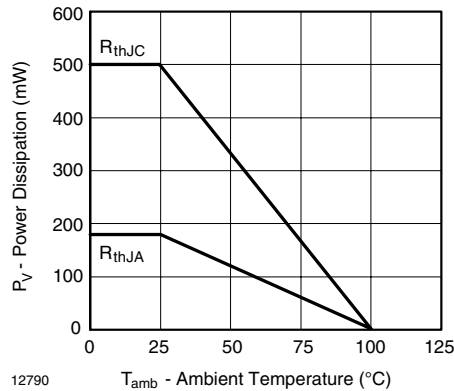


Fig. 1 - Power Dissipation Limit vs. Ambient Temperature

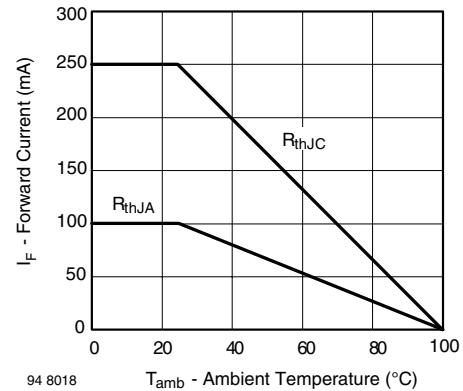


Fig. 2 - Forward Current Limit vs. Ambient Temperature

| BASIC CHARACTERISTICS | | | | | | |
|-------------------------------------|--|-----------------|------|---------|------|-------|
| PARAMETER | TEST CONDITION | SYMBOL | MIN. | TYP. | MAX. | UNIT |
| Forward voltage | $I_F = 100 \text{ mA}$, $t_p \leq 20 \text{ ms}$ | V_F | | 1.3 | 1.7 | V |
| Temperature coefficient of V_F | $I_F = 100 \text{ mA}$ | TK_{V_F} | | - 1.3 | | mV/K |
| Breakdown voltage | $I_R = 100 \text{ }\mu\text{A}$ | $V_{(BR)}$ | 5 | | | V |
| Junction capacitance | $V_R = 0 \text{ V}$, $f = 1 \text{ MHz}$, $E = 0$ | C_j | | 30 | | pF |
| Radiant intensity | $I_F = 100 \text{ mA}$, $t_p = 20 \text{ ms}$ | I_e | 10 | | 50 | mW/sr |
| Radiant power | $I_F = 100 \text{ mA}$, $t_p \leq 20 \text{ ms}$ | ϕ_e | | 7 | | mW |
| Temperature coefficient of ϕ_e | $I_F = 100 \text{ mA}$ | TK_{ϕ_e} | | - 0.8 | | %/K |
| Angle of half intensity | | φ | | ± 5 | | deg |
| Peak wavelength | $I_F = 100 \text{ mA}$ | λ_p | | 950 | | nm |
| Spectral bandwidth | $I_F = 100 \text{ mA}$ | $\Delta\lambda$ | | 50 | | nm |
| Rise time | $I_F = 100 \text{ mA}$ | t_r | | 800 | | ns |
| | $I_F = 1.5 \text{ A}$, $t_p/T = 0.01$, $t_p \leq 10 \text{ }\mu\text{s}$ | t_r | | 400 | | ns |
| Virtual source diameter | | d | | 1.5 | | mm |

Note
 $T_{amb} = 25 \text{ }^\circ\text{C}$, unless otherwise specified

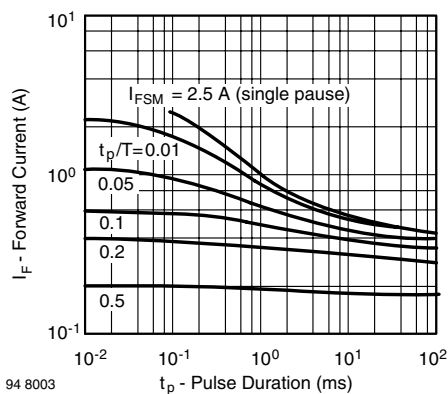
BASIC CHARACTERISTICS
 $T_{amb} = 25 \text{ }^\circ\text{C}$, unless otherwise specified


Fig. 3 - Pulse Forward Current vs. Pulse Duration

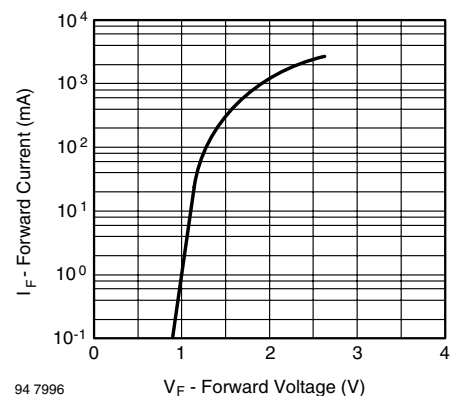


Fig. 4 - Forward Current vs. Forward Voltage

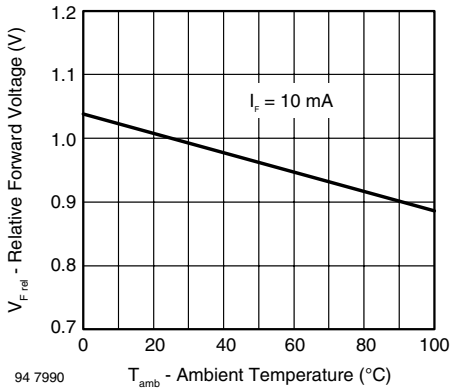


Fig. 5 - Relative Forward Voltage vs. Ambient Temperature

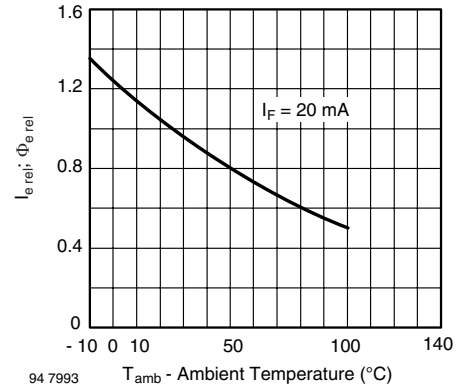


Fig. 8 - Rel. Radiant Intensity/Power vs. Ambient Temperature

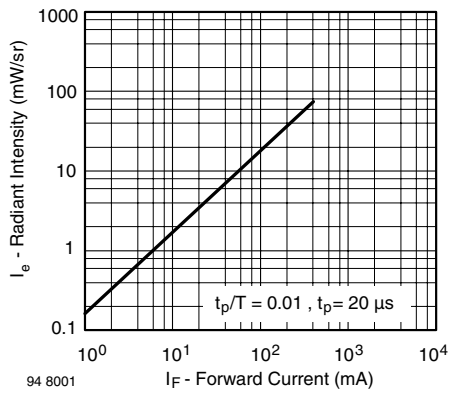


Fig. 6 - Radiant Intensity vs. Forward Current

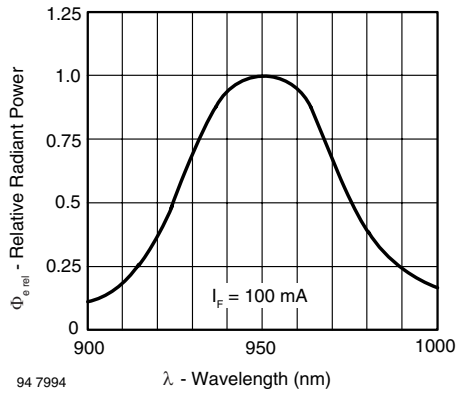


Fig. 9 - Relative Radiant Power vs. Wavelength

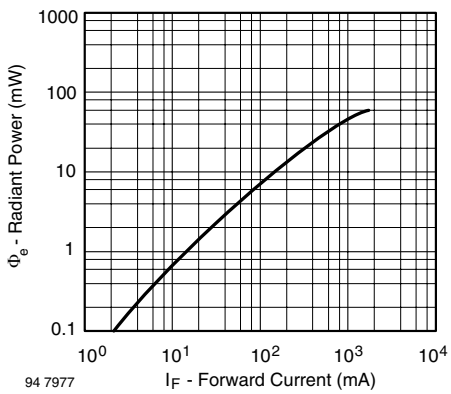


Fig. 7 - Radiant Power vs. Forward Current

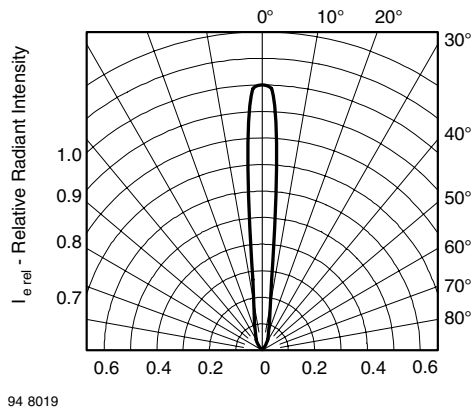
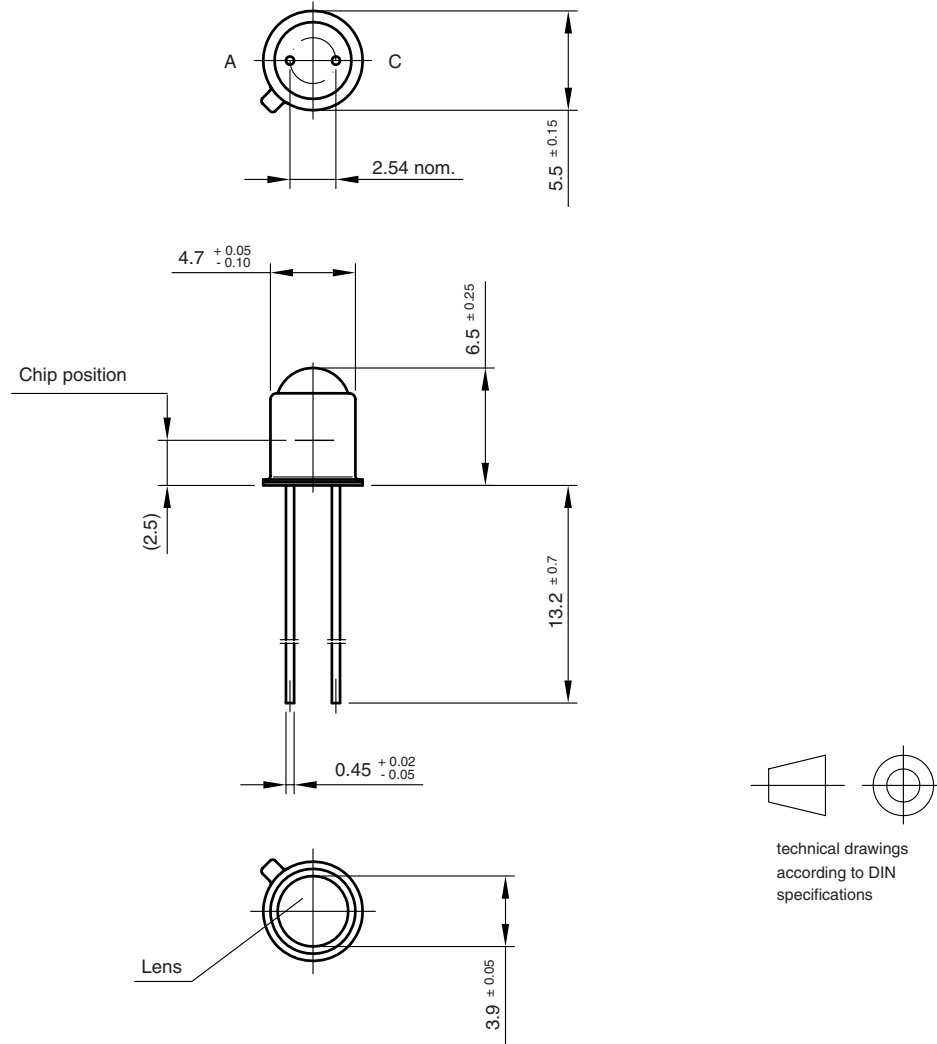


Fig. 10 - Relative Radiant Intensity vs. Angular Displacement



PACKAGE DIMENSIONS in millimeters



Drawing-No.: 6.503-5002.02-4

Issue: 1; 24.08.98

14486



Disclaimer

ALL PRODUCT, PRODUCT SPECIFICATIONS AND DATA ARE SUBJECT TO CHANGE WITHOUT NOTICE TO IMPROVE RELIABILITY, FUNCTION OR DESIGN OR OTHERWISE.

Vishay Intertechnology, Inc., its affiliates, agents, and employees, and all persons acting on its or their behalf (collectively, "Vishay"), disclaim any and all liability for any errors, inaccuracies or incompleteness contained in any datasheet or in any other disclosure relating to any product.

Vishay makes no warranty, representation or guarantee regarding the suitability of the products for any particular purpose or the continuing production of any product. To the maximum extent permitted by applicable law, Vishay disclaims (i) any and all liability arising out of the application or use of any product, (ii) any and all liability, including without limitation special, consequential or incidental damages, and (iii) any and all implied warranties, including warranties of fitness for particular purpose, non-infringement and merchantability.

Statements regarding the suitability of products for certain types of applications are based on Vishay's knowledge of typical requirements that are often placed on Vishay products in generic applications. Such statements are not binding statements about the suitability of products for a particular application. It is the customer's responsibility to validate that a particular product with the properties described in the product specification is suitable for use in a particular application. Parameters provided in datasheets and / or specifications may vary in different applications and performance may vary over time. All operating parameters, including typical parameters, must be validated for each customer application by the customer's technical experts. Product specifications do not expand or otherwise modify Vishay's terms and conditions of purchase, including but not limited to the warranty expressed therein.

Except as expressly indicated in writing, Vishay products are not designed for use in medical, life-saving, or life-sustaining applications or for any other application in which the failure of the Vishay product could result in personal injury or death. Customers using or selling Vishay products not expressly indicated for use in such applications do so at their own risk. Please contact authorized Vishay personnel to obtain written terms and conditions regarding products designed for such applications.

No license, express or implied, by estoppel or otherwise, to any intellectual property rights is granted by this document or by any conduct of Vishay. Product names and markings noted herein may be trademarks of their respective owners.