

# MOC205M, MOC206M, MOC207M, MOC208M

## Small Outline Optocouplers Transistor Output

### Features

- U.L. recognized (File #E90700, Volume 2)
- VDE recognized (File #136616)  
(add option "V" for VDE approval, i.e, MOC205VM)
- Closely matched current transfer ratios
- Convenient plastic SOIC-8 surface mountable package style
- Minimum  $BV_{CEO}$  of 70 Volts guaranteed
- Standard SOIC-8 footprint, with 0.050" lead spacing
- Compatible with dual wave, vapor phase and IR reflow soldering
- High input-output isolation of 2500  $V_{AC(rms)}$  guaranteed

### Applications

- Feedback control circuits
- Interfacing and coupling systems of different potentials and impedances
- General purpose switching circuits
- Monitor and detection circuits

### Description

These devices consist of a gallium arsenide infrared emitting diode optically coupled to a monolithic silicon phototransistor detector, in a surface mountable, small outline, plastic package. They are ideally suited for high density applications, and eliminate the need for through-the-board mounting.

### Schematic

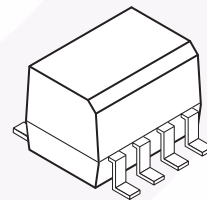
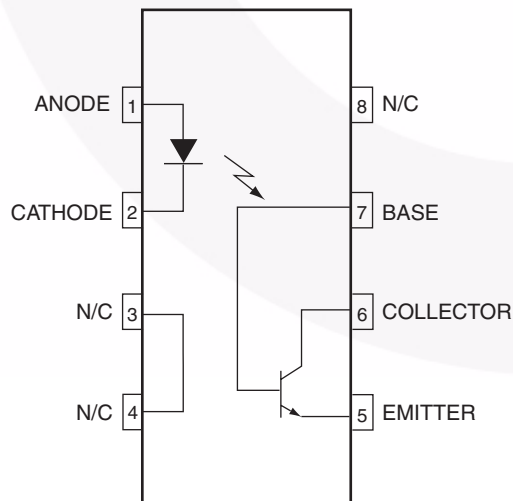

**Absolute Maximum Ratings** ( $T_A = 25^\circ\text{C}$  Unless otherwise specified)

Stresses exceeding the absolute maximum ratings may damage the device. The device may not function or be operable above the recommended operating conditions and stressing the parts to these levels is not recommended. In addition, extended exposure to stresses above the recommended operating conditions may affect device reliability. The absolute maximum ratings are stress ratings only.

Symbol	Rating	Value	Unit
<b>EMITTER</b>			
$I_F$	Forward Current – Continuous	60	mA
$I_F$ (pk)	Forward Current – Peak (PW = 100 $\mu$ s, 120pps)	1.0	A
$V_R$	Reverse Voltage	6.0	V
$P_D$	LED Power Dissipation @ $T_A = 25^\circ\text{C}$ Derate above $25^\circ\text{C}$	90	mW
		0.8	mW/ $^\circ\text{C}$
<b>DETECTOR</b>			
$V_{CEO}$	Collector-Emitter Voltage	70	V
$V_{ECO}$	Emitter-Collector Voltage	7.0	V
$V_{CBO}$	Collector-Base Voltage	70	V
$I_C$	Collector Current-Continuous	150	mA
$P_D$	Detector Power Dissipation @ $T_A = 25^\circ\text{C}$ Derate above $25^\circ\text{C}$	150	mW
		1.76	mW/ $^\circ\text{C}$
<b>TOTAL DEVICE</b>			
$V_{ISO}$	Input-Output Isolation Voltage (f = 60Hz, t = 1 min.) <sup>(1)(2)(3)</sup>	2500	Vac(rms)
$P_D$	Total Device Power Dissipation @ $T_A = 25^\circ\text{C}$ Derate above $25^\circ\text{C}$	250	mW
		2.94	mW/ $^\circ\text{C}$
$T_A$	Ambient Operating Temperature Range	-40 to +100	$^\circ\text{C}$
$T_{stg}$	Storage Temperature Range	-40 to +150	$^\circ\text{C}$

**Notes:**

1. Isolation Surge Voltage,  $V_{ISO}$ , is an internal device dielectric breakdown rating.
2. For this test, Pins 1 and 2 are common and Pins 5, 6 and 7 are common.
3.  $V_{ISO}$  rating of 2500  $V_{AC(rms)}$  for t = 1 min. is equivalent to a rating of 3,000  $V_{AC(rms)}$  for t = 1 sec.

**Electrical Characteristics** ( $T_A = 25^\circ\text{C}$  unless otherwise specified)

Symbol	Parameter	Test Conditions	Min.	Typ.*	Max.	Unit
<b>EMITTER</b>						
$V_F$	Input Forward Voltage	$I_F = 10\text{mA}$		1.15	1.5	V
$I_R$	Reverse Leakage Current	$V_R = 6.0\text{V}$		0.001	100	$\mu\text{A}$
$C_{IN}$	Input Capacitance			18		pF
<b>DETECTOR</b>						
$I_{CEO1}$ $I_{CEO2}$	Collector-Emitter Dark Current	$V_{CE} = 10\text{V}, T_A = 25^\circ\text{C}$ $V_{CE} = 10\text{V}, T_A = 100^\circ\text{C}$		1.0 1.0	50	nA $\mu\text{A}$
$BV_{CEO}$	Collector-Emitter Breakdown Voltage	$I_C = 100\mu\text{A}$	70	100		V
$BV_{ECO}$	Emitter-Collector Breakdown Voltage	$I_E = 100\mu\text{A}$	7.0	10		V
$C_{CE}$	Collector-Emitter Capacitance	$f = 1.0\text{ MHz}, V_{CE} = 0$		7.0		pF
<b>COUPLED</b>						
CTR	Collector-Output Current <sup>(4)</sup> MOC205M MOC206M MOC207M MOC208M1	$I_F = 10\text{mA}, V_{CE} = 10\text{V}$	40 63 100 40		80 125 200 125	%
$V_{ISO}$	Isolation Surge Voltage <sup>(1)(2)(3)</sup>	$f = 60\text{ Hz AC Peak}, t = 1\text{ min.}$	2500			Vac(rms)
$R_{ISO}$	Isolation Resistance <sup>(2)</sup>	$V = 500\text{V}$	$10^{11}$			$\Omega$
$V_{CE(sat)}$	Collector-Emitter Saturation Voltage	$I_C = 2\text{mA}, I_F = 10\text{mA}$			0.4	V
$C_{ISO}$	Isolation Capacitance <sup>(2)</sup>	$V = 0\text{V}, f = 1\text{MHz}$		0.2		pF
$t_{on}$	Turn-On Time	$I_C = 2.0\text{mA}, V_{CC} = 10\text{V},$ $R_L = 100\Omega$ (Fig. 6)		7.5		$\mu\text{s}$
$t_{off}$	Turn-Off Time	$I_C = 2.0\text{mA}, V_{CC} = 10\text{V},$ $R_L = 100\Omega$ (Fig. 6)		5.7		$\mu\text{s}$
$t_r$	Rise Time	$I_C = 2.0\text{mA}, V_{CC} = 10\text{V},$ $R_L = 100\Omega$ (Fig. 6)		3.2		$\mu\text{s}$
$t_f$	Fall Time	$I_C = 2.0\text{ mA}, V_{CC} = 10\text{V},$ $R_L = 100\Omega$ (Fig. 6)		4.7		$\mu\text{s}$

\*Typical values at  $T_A = 25^\circ\text{C}$ **Notes:**

1. Isolation Surge Voltage,  $V_{ISO}$ , is an internal device dielectric breakdown rating.
2. For this test, Pins 1 and 2 are common and Pins 5, 6 and 7 are common.
3.  $V_{ISO}$  rating of 2500  $V_{AC(rms)}$  for  $t = 1\text{ min.}$  is equivalent to a rating of 3,000  $V_{AC(rms)}$  for  $t = 1\text{ sec.}$
4. Current Transfer Ratio (CTR) =  $I_C/I_F \times 100\%$ .

## Typical Performance Curves

**Fig. 1 LED Forward Voltage vs. Forward Current**

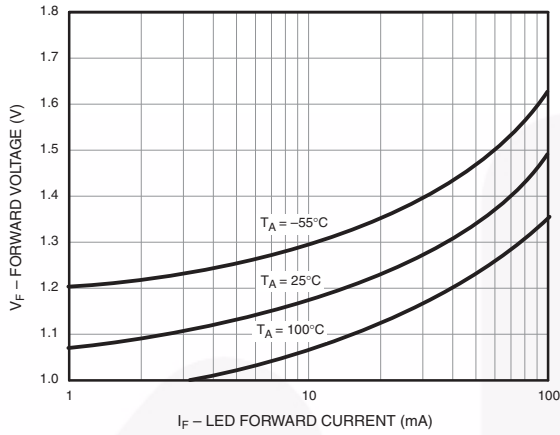

**Fig. 2 Output Current vs. Input Current**

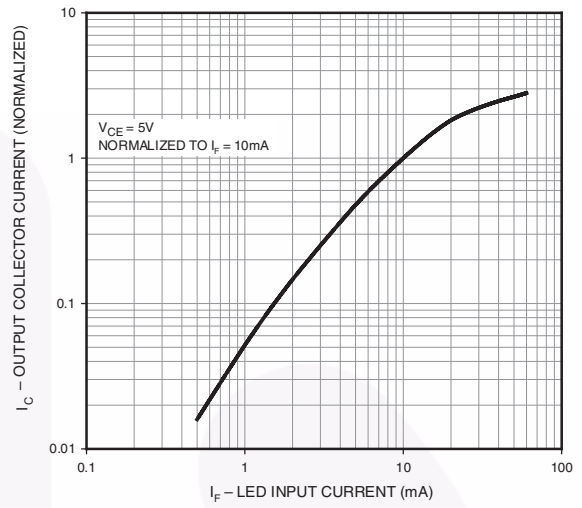

**Fig. 3 Output Current vs. Ambient Temperature**

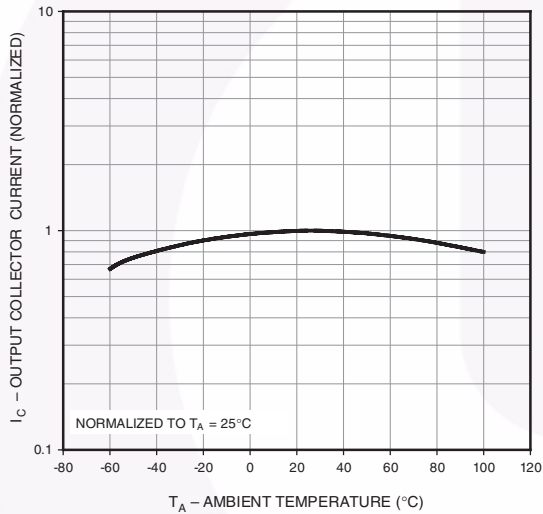

**Fig. 4 Output Current vs. Collector-Emitter Voltage**

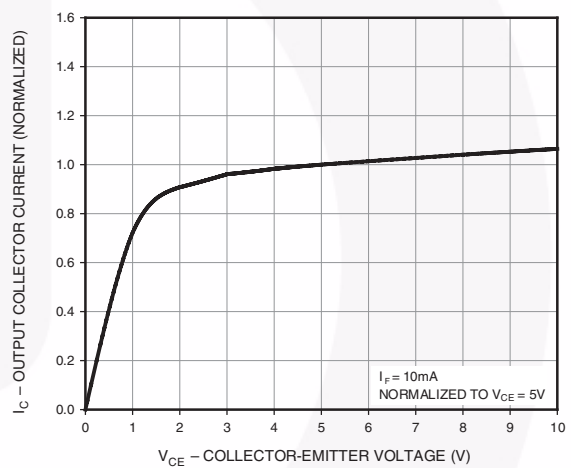

**Fig. 5 Dark Current vs. Ambient Temperature**

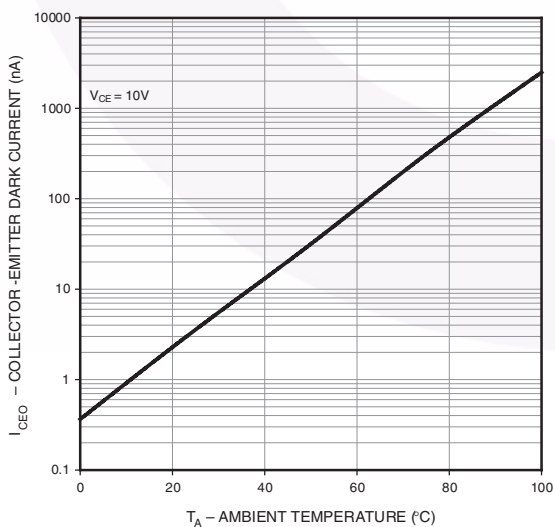

**Fig. 6 CTR vs. RBE (Unsaturated)**

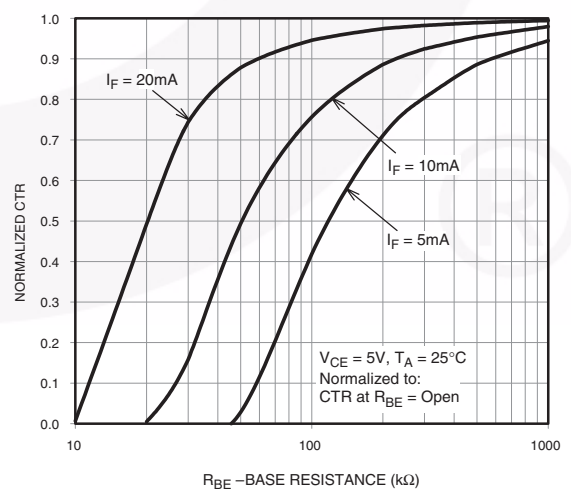

Typical Performance Curves (Continued)

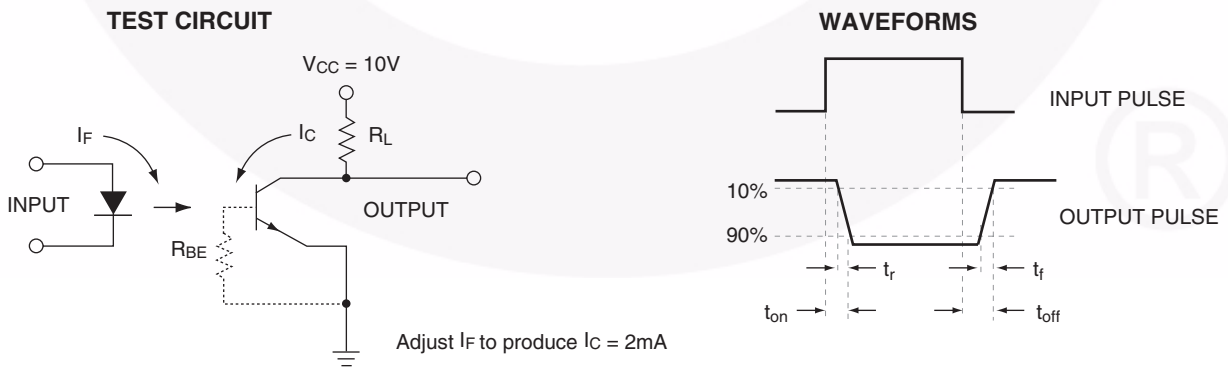
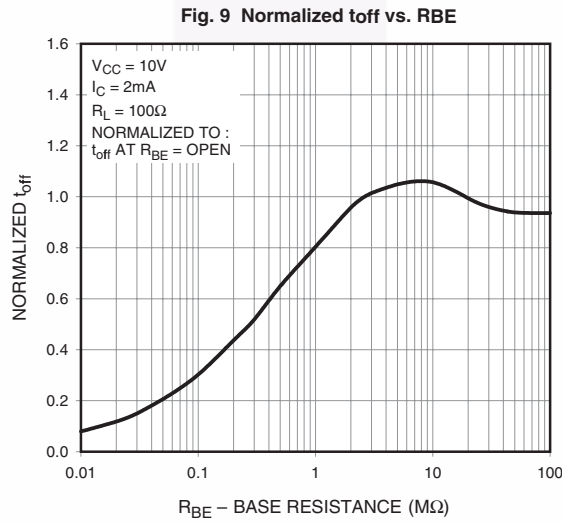
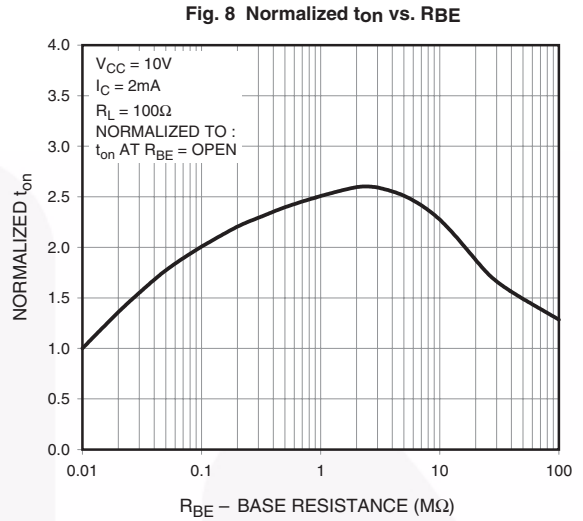
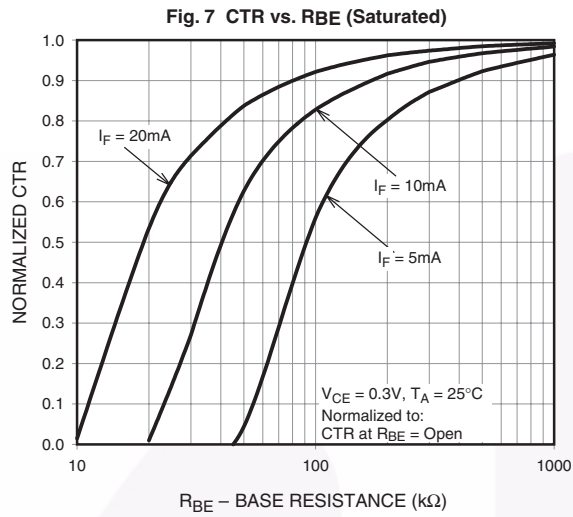
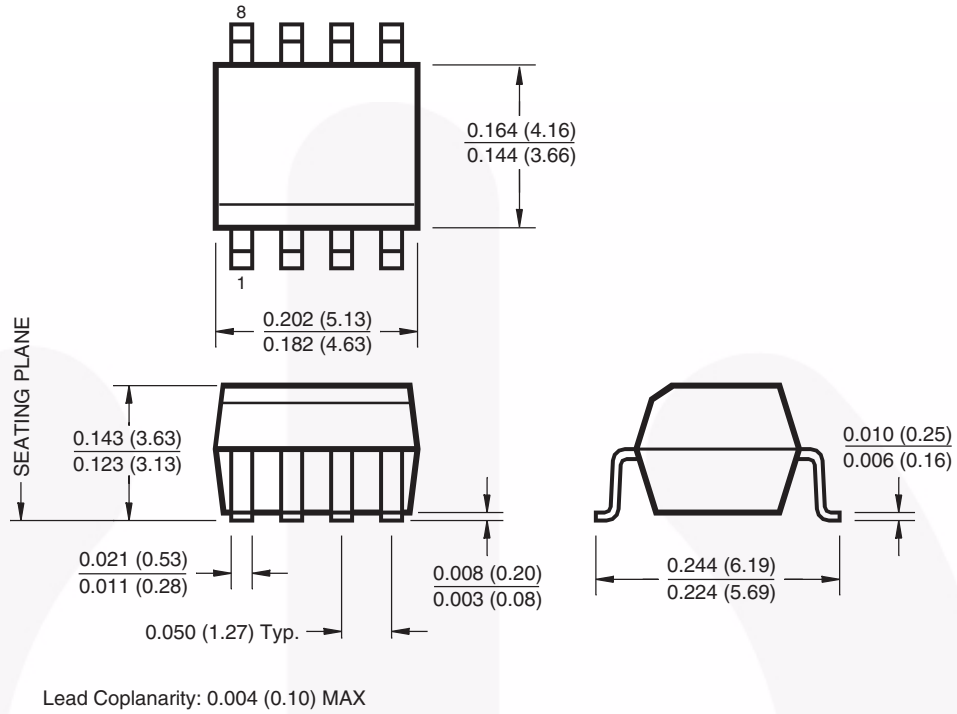

Figure 10. Switching Time Test Circuit and Waveforms

## Package Dimensions

### 8-pin SOIC Surface Mount



### Recommended Pad Layout

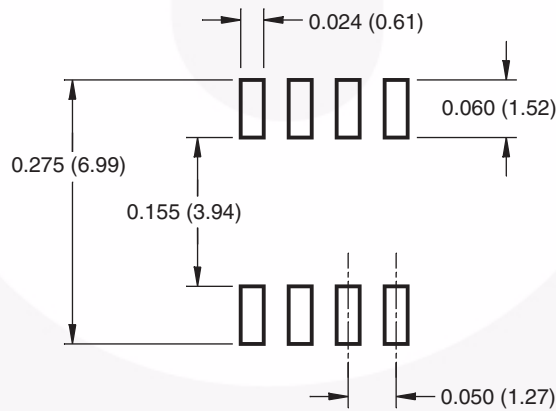

Dimensions in inches (mm).

Package drawings are provided as a service to customers considering Fairchild components. Drawings may change in any manner without notice. Please note the revision and/or date on the drawing and contact a Fairchild Semiconductor representative to verify or obtain the most recent revision. Package specifications do not expand the terms of Fairchild's worldwide terms and conditions, specifically the warranty therein, which covers Fairchild products.

Always visit Fairchild Semiconductor's online packaging area for the most recent package drawings:

<http://www.fairchildsemi.com/packaging/>

### Ordering Information

Option	Order Entry Identifier	Description
V	V	VDE 0884
R2	R2	Tape and reel (2500 units per reel)
R2V	R2V	VDE 0884, Tape and reel (2500 units per reel)

### Marking Information

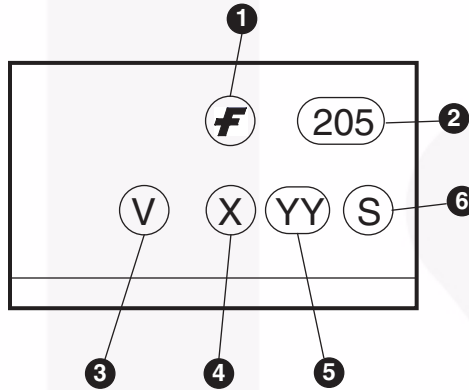

#### Definitions

1	Fairchild logo
2	Device number
3	VDE mark (Note: Only appears on parts ordered with VDE option – See order entry table)
4	One digit year code, e.g., '8'
5	Two digit work week ranging from '01' to '53'
6	Assembly package code

### Carrier Tape Specifications

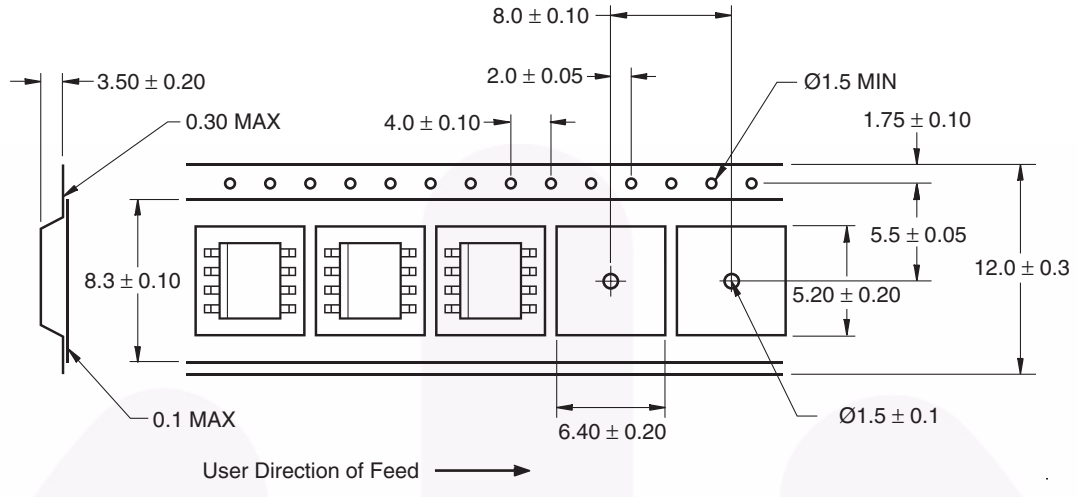



## Reflow Profile

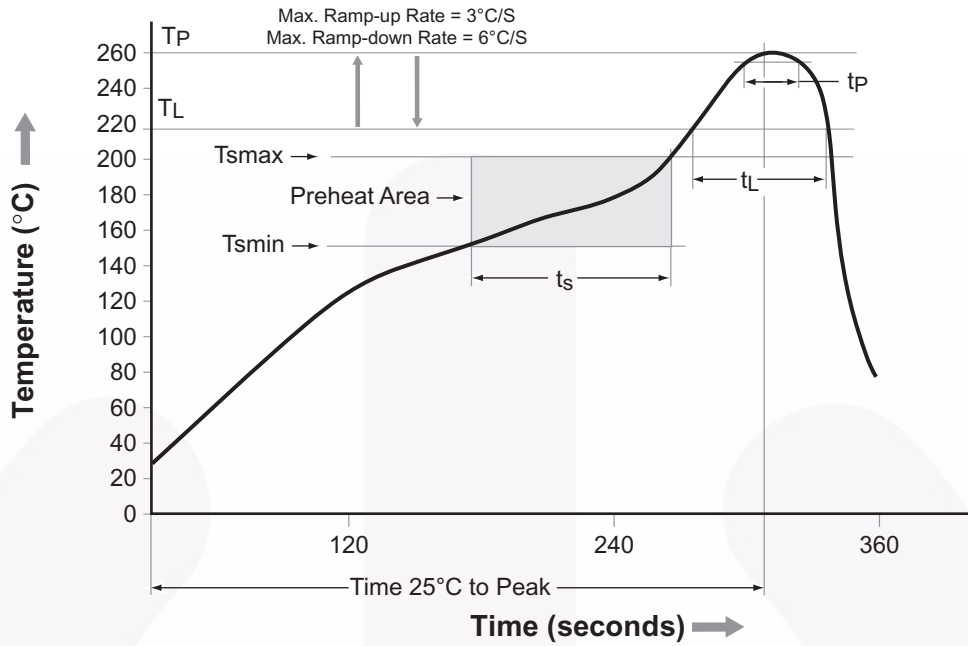



Profile Feature	Pb-Free Assembly Profile
Temperature Min. (T <sub>smín</sub> )	150°C
Temperature Max. (T <sub>smáx</sub> )	200°C
Time (t <sub>s</sub> ) from (T <sub>smín</sub> to T <sub>smáx</sub> )	60–120 seconds
Ramp-up Rate (t <sub>L</sub> to t <sub>p</sub> )	3°C/second max.
Liquidous Temperature (T <sub>L</sub> )	217°C
Time (t <sub>L</sub> ) Maintained Above (T <sub>L</sub> )	60–150 seconds
Peak Body Package Temperature	260°C +0°C / -5°C
Time (t <sub>p</sub> ) within 5°C of 260°C	30 seconds
Ramp-down Rate (T <sub>p</sub> to T <sub>L</sub> )	6°C/second max.
Time 25°C to Peak Temperature	8 minutes max.



**TRADEMARKS**

The following includes registered and unregistered trademarks and service marks, owned by Fairchild Semiconductor and/or its global subsidiaries, and is not intended to be an exhaustive list of all such trademarks.

- |   |                        |   |   |
|---|------------------------|---|---|
| Auto-SPM™   | F-PFS™                 | PowerTrench®  | The Power Franchise®  |
| Build it Now™   | FRFET®                 | PowerXS™  | the power franchise   |
| CorePLUS™   | Global Power Resource™ | Programmable Active Droop™  | QFET™   |
| CorePOWER™  | Green FPS™             | Quiet Series™   | TinyBoost™  |
| CROSSVOLT™  | Green FPS™ e-Series™   | QST™  | TinyBuck™   |
| CTL™  | Gmax™                  | RapidConfigure™   | TinyLogic®  |
| Current Transfer Logic™   | GTO™                   |   | TINYOPTO™   |
| EcoSPARK®   | IntelliMAX™            |  | TinyPower™  |
| EfficientMax™   | ISOPLANAR™             | Saving our world, 1mW/W/kW at a time™   | TinyPWM™  |
| EZSWITCH™*  | MegaBuck™              | SmartMax™   | TinyWire™   |
|  | MICROCOUPLER™          | SMART START™  | TriFault Detect™  |
|  | MicroFET™              | SPM®  | TRUECURRENT™*   |
| Fairchild®  | MicroPak™              | STEALTH™  | μSerDes™  |
| Fairchild Semiconductor®  | MillerDrive™           | SuperFET™   |  |
| FACT Quiet Series™  | MotionMax™             | SuperSOT™-3   | UHC®  |
| FACT®   | Motion-SPM™            | SuperSOT™-6   | Ultra FRFET™  |
| FAST®   | OPTOLOGIC®             | SuperSOT™-8   | UniFET™   |
| FAST®   | OPTOPLANAR®            | SupreMOS™   | VCX™  |
| FastvCore™  |                        | SyncFET™  | VisualMax™  |
| FETBench™   | PDP SPM™               | Sync-Lock™  | XS™   |
| FlashWriter®*   | Power-SPM™             |  |   |
| FPS™  |                        |   |   |

\* Trademarks of System General Corporation, used under license by Fairchild Semiconductor.

**DISCLAIMER**

FAIRCHILD SEMICONDUCTOR RESERVES THE RIGHT TO MAKE CHANGES WITHOUT FURTHER NOTICE TO ANY PRODUCTS HEREIN TO IMPROVE RELIABILITY, FUNCTION, OR DESIGN. FAIRCHILD DOES NOT ASSUME ANY LIABILITY ARISING OUT OF THE APPLICATION OR USE OF ANY PRODUCT OR CIRCUIT DESCRIBED HEREIN; NEITHER DOES IT CONVEY ANY LICENSE UNDER ITS PATENT RIGHTS, NOR THE RIGHTS OF OTHERS. THESE SPECIFICATIONS DO NOT EXPAND THE TERMS OF FAIRCHILD'S WORLDWIDE TERMS AND CONDITIONS, SPECIFICALLY THE WARRANTY THEREIN, WHICH COVERS THESE PRODUCTS.

**LIFE SUPPORT POLICY**

FAIRCHILD'S PRODUCTS ARE NOT AUTHORIZED FOR USE AS CRITICAL COMPONENTS IN LIFE SUPPORT DEVICES OR SYSTEMS WITHOUT THE EXPRESS WRITTEN APPROVAL OF FAIRCHILD SEMICONDUCTOR CORPORATION.

As used herein:

1. Life support devices or systems are devices or systems which, (a) are intended for surgical implant into the body or (b) support or sustain life, and (c) whose failure to perform when properly used in accordance with instructions for use provided in the labeling, can be reasonably expected to result in a significant injury of the user.
2. A critical component in any component of a life support, device, or system whose failure to perform can be reasonably expected to cause the failure of the life support device or system, or to affect its safety or effectiveness.

**ANTI-COUNTERFEITING POLICY**

Fairchild Semiconductor Corporation's Anti-Counterfeiting Policy. Fairchild's Anti-Counterfeiting Policy is also stated on our external website, [www.fairchildsemi.com](http://www.fairchildsemi.com), under Sales Support.

Counterfeiting of semiconductor parts is a growing problem in the industry. All manufacturers of semiconductor products are experiencing counterfeiting of their parts. Customers who inadvertently purchase counterfeit parts experience many problems such as loss of brand reputation, substandard performance, failed applications, and increased cost of production and manufacturing delays. Fairchild is taking strong measures to protect ourselves and our customers from the proliferation of counterfeit parts. Fairchild strongly encourages customers to purchase Fairchild parts either directly from Fairchild or from Authorized Fairchild Distributors who are listed by country on our web page cited above. Products customers buy either from Fairchild directly or from Authorized Fairchild Distributors are genuine parts, have full traceability, meet Fairchild's quality standards for handling and storage and provide access to Fairchild's full range of up-to-date technical and product information. Fairchild and our Authorized Distributors will stand behind all warranties and will appropriately address any warranty issues that may arise. Fairchild will not provide any warranty coverage or other assistance for parts bought from Unauthorized Sources. Fairchild is committed to combat this global problem and encourage our customers to do their part in stopping this practice by buying direct or from authorized distributors.

**PRODUCT STATUS DEFINITIONS**

**Definition of Terms**

Datasheet Identification	Product Status	Definition
Advance Information	Formative / In Design	Datasheet contains the design specifications for product development. Specifications may change in any manner without notice.
Preliminary	First Production	Datasheet contains preliminary data; supplementary data will be published at a later date. Fairchild Semiconductor reserves the right to make changes at any time without notice to improve design.
No Identification Needed	Full Production	Datasheet contains final specifications. Fairchild Semiconductor reserves the right to make changes at any time without notice to improve the design.
Obsolete	Not In Production	Datasheet contains specifications on a product that is discontinued by Fairchild Semiconductor. The datasheet is for reference information only.

Rev. 140