

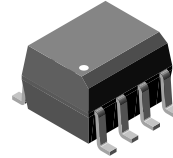

## Optocoupler, Phototransistor Output, With Base Connection in SOIC-8 package

### Features

- High  $BV_{CEO}$ , 70 V
- Isolation Test Voltage, 3000  $V_{RMS}$
- Industry Standard SOIC-8A Surface Mountable Package
- Compatible with Dual Wave, Vapor Phase and IR Reflow Soldering
- Lead (Pb)-free component
- Component in accordance to RoHS 2002/95/EC and WEEE 2002/96/EC



1179002

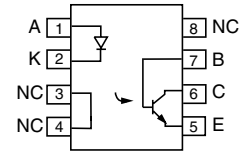

### Agency Approvals

- UL1577, File No. E52744 System Code Y
- DIN EN 60747-5-2 (VDE0884)  
DIN EN 60747-5-5 pending  
Available with Option 1

A specified minimum and maximum CTR allows a narrow tolerance in the electrical design of the adjacent circuits. The high  $BV_{CEO}$  of 70 V gives a higher safety margin compared to the industry standard 30 V.

### Description

The IL205AT/ IL206AT/ IL207AT/ IL208AT are optically coupled pairs with a Gallium Arsenide infrared LED and a silicon NPN phototransistor. Signal information, including a DC level, can be transmitted by the device while maintaining a high degree of electrical isolation between input and output. This family comes in a standard SOIC-8A small outline package for surface mounting which makes them ideally suited for high density application with limited space. In addition to eliminating through-hole requirements, this package conforms to standards for surface mounted devices.

### Order Information

Part	Remarks
IL205AT	CTR 40 - 80 %, SOIC-8
IL206AT	CTR 63 - 125 %, SOIC-8
IL207AT	CTR 100 - 200 %, SOIC-8
IL208AT	CTR 160 - 320 %, SOIC-8

Available on Tape and Reel only.

For additional information on the available options refer to Option Information.

### Absolute Maximum Ratings

$T_{amb} = 25\text{ }^{\circ}\text{C}$ , unless otherwise specified

Stresses in excess of the absolute Maximum Ratings can cause permanent damage to the device. Functional operation of the device is not implied at these or any other conditions in excess of those given in the operational sections of this document. Exposure to absolute Maximum Rating for extended periods of the time can adversely affect reliability.

### Input

Parameter	Test condition	Symbol	Value	Unit
Peak reverse voltage		$V_R$	6.0	V
Forward continuous current		$I_F$	60	mA
Power dissipation		$P_{diss}$	90	mW
Derate linearly from 25 $^{\circ}\text{C}$			1.2	mW/ $^{\circ}\text{C}$

### Output

Parameter	Test condition	Symbol	Value	Unit
Collector-emitter breakdown voltage		$BV_{CEO}$	70	V
Emitter-collector breakdown voltage		$BV_{ECO}$	7.0	V
Collector-base breakdown voltage		$BV_{CBO}$	70	V
$I_{CMAX DC}$		$I_{CMAX DC}$	50	mA
$I_{CMAX}$	$t < 1.0 \text{ ms}$	$I_{CMAX}$	100	mA
Power dissipation		$P_{diss}$	150	mW
Derate linearly from 25 °C			2.0	mW/°C

### Coupler

Parameter	Test condition	Symbol	Value	Unit
Total package dissipation (LED + detector)		$P_{tot}$	240	mW
Derate linearly from 25 °C			3.3	mW/°C
Operating temperature		$T_{amb}$	- 55 to + 100	°C
Storage temperature		$T_{stg}$	- 55 to + 150	°C
Soldering time	at 260 °C		10	s

### Electrical Characteristics

$T_{amb} = 25 \text{ °C}$ , unless otherwise specified

Minimum and maximum values are testing requirements. Typical values are characteristics of the device and are the result of engineering evaluation. Typical values are for information only and are not part of the testing requirements.

### Input

Parameter	Test condition	Symbol	Min	Typ.	Max	Unit
Forward voltage	$I_F = 10 \text{ mA}$	$V_F$		1.3	1.5	V
Reverse current	$V_R = 6.0 \text{ V}$	$I_R$		0.1	100	μA
Capacitance	$V_R = 0 \text{ V}$	$C_O$		13		pF

### Output

Parameter	Test condition	Symbol	Min	Typ.	Max	Unit
Collector-emitter breakdown voltage	$I_C = 100 \text{ μA}$	$BV_{CEO}$	70			V
Emitter-collector breakdown voltage	$I_E = 100 \text{ μA}$	$BV_{ECO}$	7.0	10		V
Collector-emitter leakage current	$V_{CE} = 10 \text{ V}$	$I_{CEO}$		5.0	50	nA

### Coupler

Parameter	Test condition	Symbol	Min	Typ.	Max	Unit
Saturation voltage, collector-emitter	$I_C = 2.0 \text{ mA}$ , $I_F = 10 \text{ mA}$	$V_{CEsat}$			0.4	V
Isolation test voltage		$V_{ISO}$	3000			$V_{RMS}$
Equivalent DC, isolation voltage			3535			VDC
Capacitance (input-output)		$C_{IO}$		0.5		pF
Resistance, input to output		$R_{IO}$		100		Ω



## Current Transfer Ratio

Parameter	Test condition	Part	Symbol	Min	Typ.	Max	Unit
Current Transfer Ratio	$I_F = 10 \text{ mA}, V_{CE} = 5.0 \text{ V}$	IL205AT	CTR	40		80	%
		IL206AT	CTR	63		125	%
		IL207AT	CTR	100		200	%
		IL208AT	CTR	100		320	%
	$I_F = 1.0 \text{ mA}, V_{CE} = 5.0 \text{ V}$	IL205AT	CTR	13	25		%
		IL206AT	CTR	22	40		%
		IL207AT	CTR	34	60		%
		IL208AT	CTR	56	95		%

## Switching Characteristics

Parameter	Test condition	Symbol	Min	Typ.	Max	Unit
Switching time	$I_C = 2 \text{ mA}, R_L = 100 \Omega, V_{CC} = 10 \text{ V}$	$t_{on}, t_{off}$		3.0		$\mu\text{s}$

## Typical Characteristics ( $T_{amb} = 25^\circ\text{C}$ unless otherwise specified)

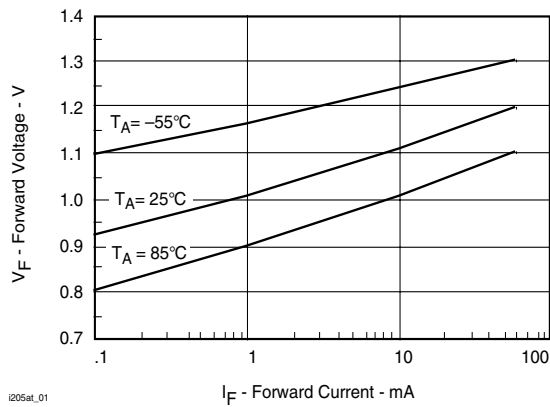

Figure 1. Forward Voltage vs. Forward Current

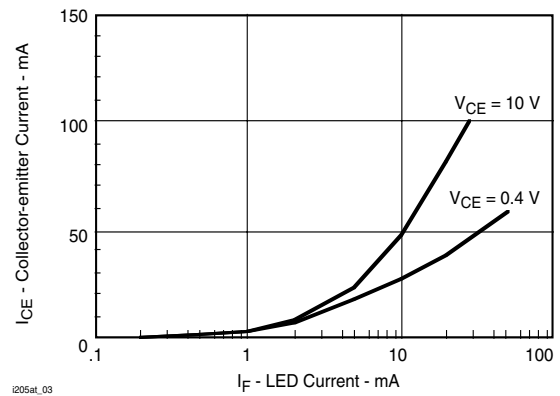

Figure 3. Collector-Emitter Current vs. LED Current

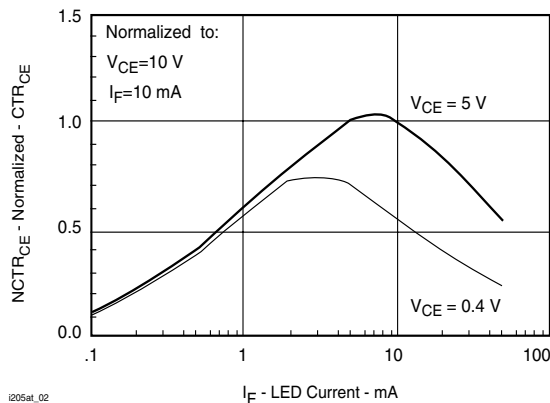

Figure 2. Normalized Non-saturated and Saturated  $CTR_{CE}$  vs. LED Current

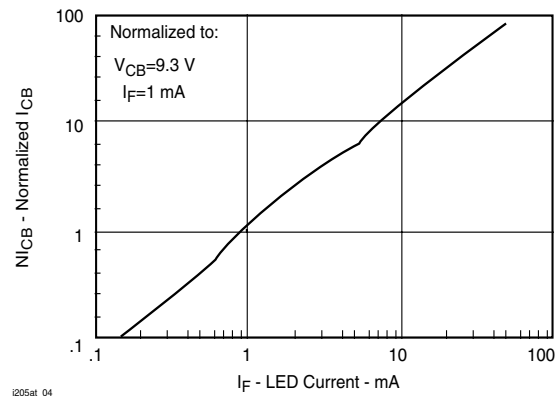

Figure 4. Normalized Collector-Base Photocurrent vs. LED Current

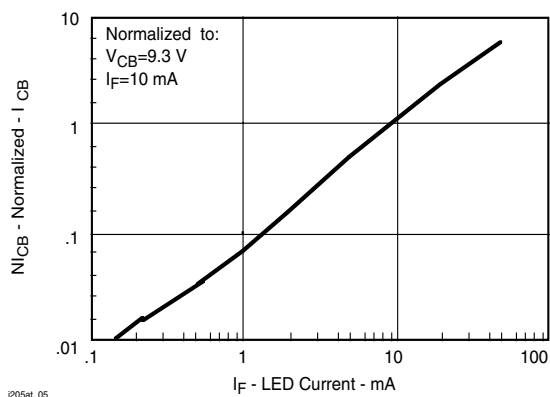

Figure 5. Normalized Collector-Base Photocurrent vs. LED Current

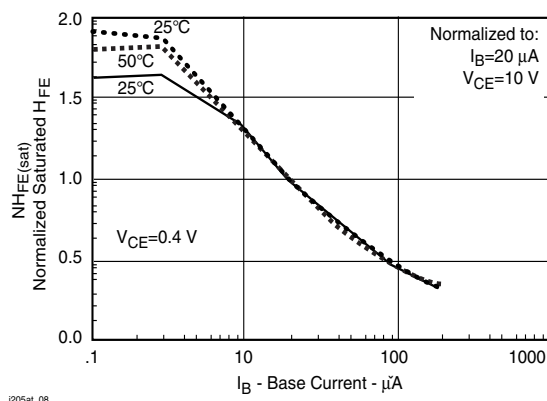

Figure 8. Base Current vs.  $I_F$  and HFE

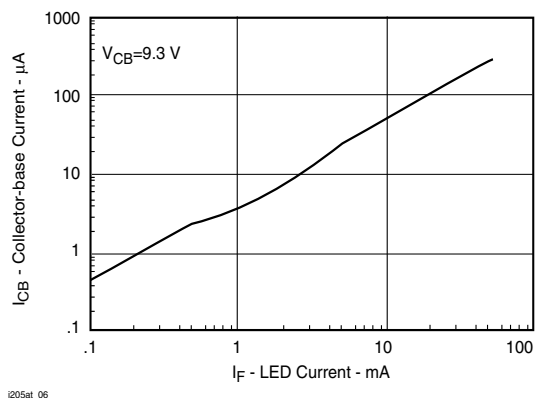

Figure 6. Collector-Emitter Photocurrent vs. LED Current

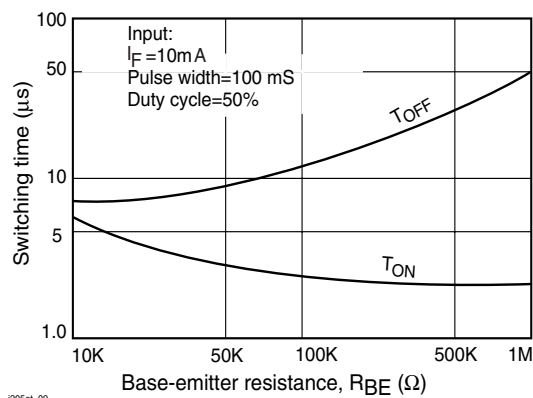

Figure 9. Typical Switching Characteristics vs. Base Resistance (Saturated Operation)

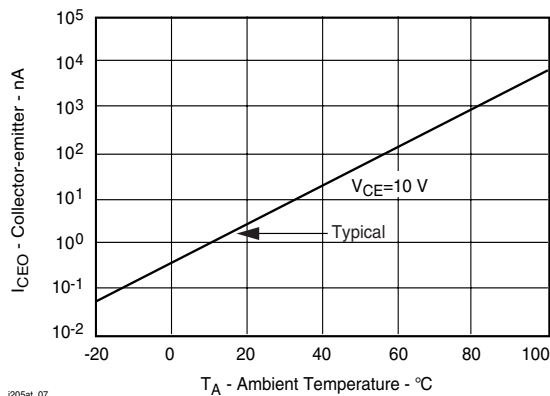
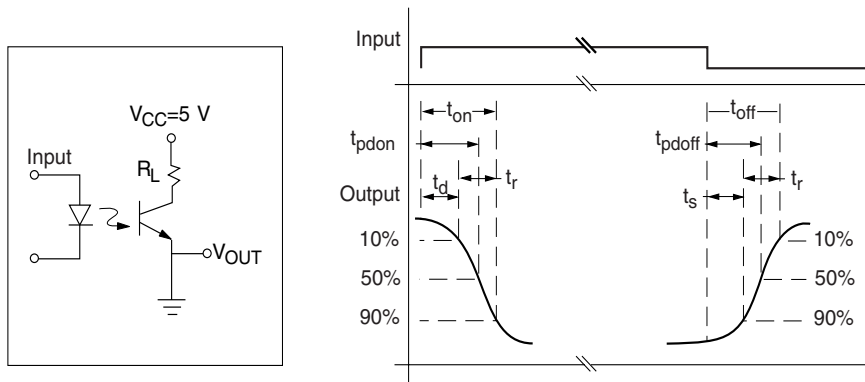

Figure 7. Collector-Emitter Photocurrent vs. LED Current



i205at\_11

Figure 10. Switching Test Circuit

## Package Dimensions in Inches (mm)

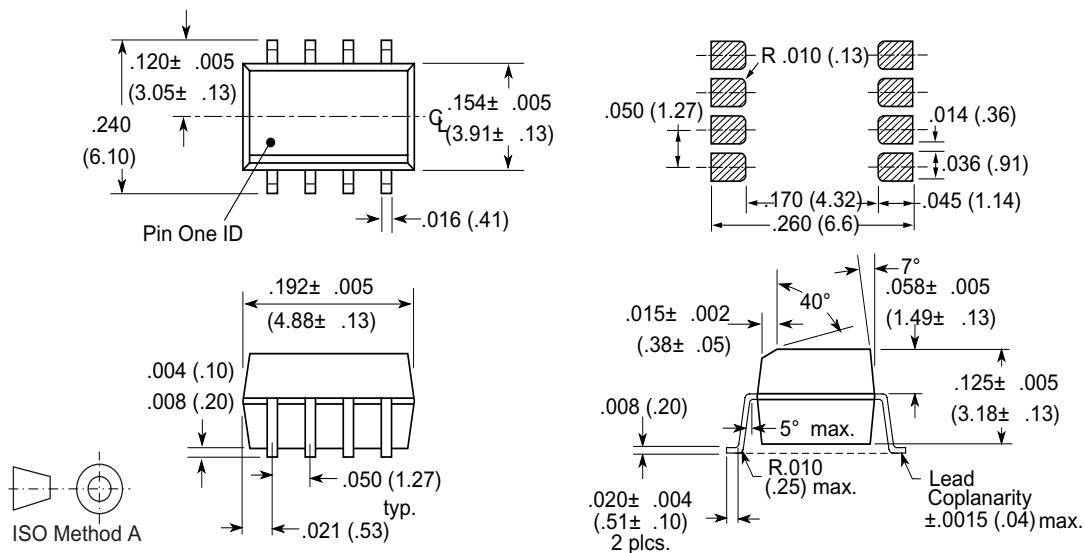

i178003

### Ozone Depleting Substances Policy Statement

It is the policy of Vishay Semiconductor GmbH to

1. Meet all present and future national and international statutory requirements.
2. Regularly and continuously improve the performance of our products, processes, distribution and operating systems with respect to their impact on the health and safety of our employees and the public, as well as their impact on the environment.

It is particular concern to control or eliminate releases of those substances into the atmosphere which are known as ozone depleting substances (ODSs).

The Montreal Protocol (1987) and its London Amendments (1990) intend to severely restrict the use of ODSs and forbid their use within the next ten years. Various national and international initiatives are pressing for an earlier ban on these substances.

Vishay Semiconductor GmbH has been able to use its policy of continuous improvements to eliminate the use of ODSs listed in the following documents.

1. Annex A, B and list of transitional substances of the Montreal Protocol and the London Amendments respectively
2. Class I and II ozone depleting substances in the Clean Air Act Amendments of 1990 by the Environmental Protection Agency (EPA) in the USA
3. Council Decision 88/540/EEC and 91/690/EEC Annex A, B and C (transitional substances) respectively.

Vishay Semiconductor GmbH can certify that our semiconductors are not manufactured with ozone depleting substances and do not contain such substances.

We reserve the right to make changes to improve technical design  
and may do so without further notice.

Parameters can vary in different applications. All operating parameters must be validated for each customer application by the customer. Should the buyer use Vishay Semiconductors products for any unintended or unauthorized application, the buyer shall indemnify Vishay Semiconductors against all claims, costs, damages, and expenses, arising out of, directly or indirectly, any claim of personal damage, injury or death associated with such unintended or unauthorized use.

Vishay Semiconductor GmbH, P.O.B. 3535, D-74025 Heilbronn, Germany



---

**Notice**

Specifications of the products displayed herein are subject to change without notice. Vishay Intertechnology, Inc., or anyone on its behalf, assumes no responsibility or liability for any errors or inaccuracies.

Information contained herein is intended to provide a product description only. No license, express or implied, by estoppel or otherwise, to any intellectual property rights is granted by this document. Except as provided in Vishay's terms and conditions of sale for such products, Vishay assumes no liability whatsoever, and disclaims any express or implied warranty, relating to sale and/or use of Vishay products including liability or warranties relating to fitness for a particular purpose, merchantability, or infringement of any patent, copyright, or other intellectual property right.

The products shown herein are not designed for use in medical, life-saving, or life-sustaining applications. Customers using or selling these products for use in such applications do so at their own risk and agree to fully indemnify Vishay for any damages resulting from such improper use or sale.