

4N25X, 4N26X, 4N27X, 4N28X  
4N25, 4N26, 4N27, 4N28



**OPTICALLY COUPLED  
ISOLATOR  
PHOTOTRANSISTOR OUTPUT**

**APPROVALS**

- UL recognised, File No. E91231
- 'X' SPECIFICATION APPROVALS
  - VDE 0884 in 3 available lead form :-
    - STD
    - G form
    - SMD approved to CECC 00802
  - Certified to EN60950 by the following Test Bodies :-
    - Nemko - Certificate No. P01102464
    - Fimko - Certificate No. FI18166
    - Semko - Reference No. 0202037/01-22
    - Demko - Certificate No. 311158-01
  - BSI approved - Certificate No. 8001

**DESCRIPTION**

The 4N25, 4N26, 4N27, 4N28 series of optically coupled isolators consist of infrared light emitting diode and NPN silicon photo transistor in a standard 6 pin dual in line plastic package.

**FEATURES**

- Options :-
  - 10mm lead spread - add G after part no.
  - Surface mount - add SM after part no.
  - Tape&reel - add SMT&R after part no.
- High Isolation Voltage (5.3kV<sub>RMS</sub>, 7.5kV<sub>PK</sub>)
- All electrical parameters 100% tested
- Custom electrical selections available

**APPLICATIONS**

- DC motor controllers
- Industrial systems controllers
- Measuring instruments
- Signal transmission between systems of different potentials and impedances

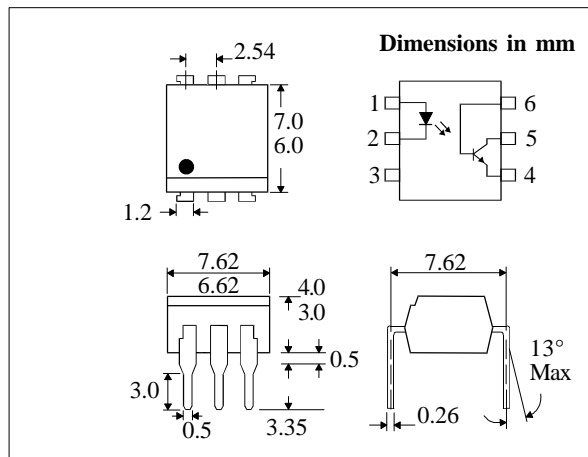
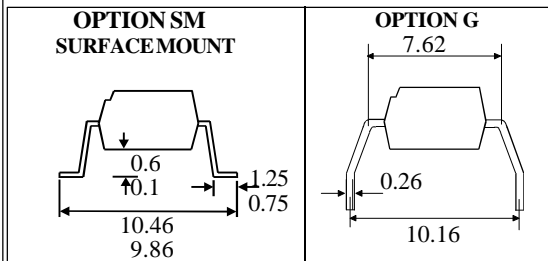

**ABSOLUTE MAXIMUM RATINGS  
(25°C unless otherwise specified)**

Storage Temperature	-55°C to + 150°C
Operating Temperature	-55°C to + 100°C
Lead Soldering Temperature (1/16 inch (1.6mm) from case for 10 secs)	260°C

**INPUT DIODE**

Forward Current	60mA
Reverse Voltage	6V
Power Dissipation	105mW

**OUTPUT TRANSISTOR**

Collector-emitter Voltage $BV_{CEO}$	30V
Collector-base Voltage $BV_{CBO}$	70V
Emitter-collector Voltage $BV_{ECO}$	6V
Power Dissipation	160mW

**POWER DISSIPATION**

Total Power Dissipation	200mW
(derate linearly 2.67mW/°C above 25°C)	

**ISOCOM COMPONENTS LTD**  
Unit 25B, Park View Road West,  
Park View Industrial Estate, Brenda Road  
Hartlepool, TS25 1YD England Tel: (01429)863609  
Fax: (01429) 863581 e-mail sales@isocom.co.uk  
<http://www.isocom.com>

**ELECTRICAL CHARACTERISTICS (  $T_A = 25^\circ\text{C}$  Unless otherwise noted )**

PARAMETER		MIN	TYP	MAX	UNITS	TEST CONDITION
Input	Forward Voltage ( $V_F$ )		1.2	1.5	V	$I_F = 10\text{mA}$
	Reverse Current ( $I_R$ )			10	$\mu\text{A}$	$V_R = 6\text{V}$
Output	Collector-emitter Breakdown ( $BV_{CEO}$ ) ( Note 2 )	30			V	$I_C = 1\text{mA}$
	Collector-base Breakdown ( $BV_{CBO}$ )	70			V	$I_C = 100\mu\text{A}$
	Emitter-collector Breakdown ( $BV_{ECO}$ )	6			V	$I_E = 100\mu\text{A}$
	Collector-emitter Dark Current ( $I_{CEO}$ )			50	nA	$V_{CE} = 10\text{V}$
	Collector-base Dark Current ( $I_{CBO}$ )			20	nA	$V_{CE} = 10\text{V}$
Coupled	Current Transfer Ratio (CTR) 4N25, 4N26	20			%	$10\text{mA } I_F, 10\text{V } V_{CE}$
	4N27, 4N28	10			%	$10\text{mA } I_F, 10\text{V } V_{CE}$
	Collector-emitter Saturation Voltage $V_{CE(SAT)}$			0.5	V	$50\text{mA } I_F, 2\text{mA } I_C$
	Input to Output Isolation Voltage $V_{ISO}$	5300			$V_{RMS}$	See note 1
		7500			$V_{PK}$	See note 1
	Input-output Isolation Resistance $R_{ISO}$	$5 \times 10^{10}$			$\Omega$	$V_{IO} = 500\text{V}$ (note 1)
	Turn-on Time $t_{on}$		4		$\mu\text{s}$	$V_{CC} = 10\text{V},$ $I_F = 10\text{mA}, R_L = 100\Omega$ ( FIG 1 )
Turn-off Time $t_{off}$		3		$\mu\text{s}$		
Output Rise Time $t_r$		2		$\mu\text{s}$		
Output Fall Time $t_f$		2		$\mu\text{s}$		

- Note 1 Measured with input leads shorted together and output leads shorted together.  
 Note 2 Special Selections are available on request. Please consult the factory.

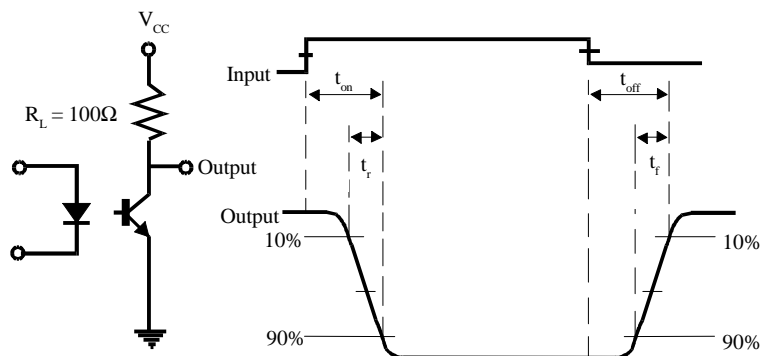
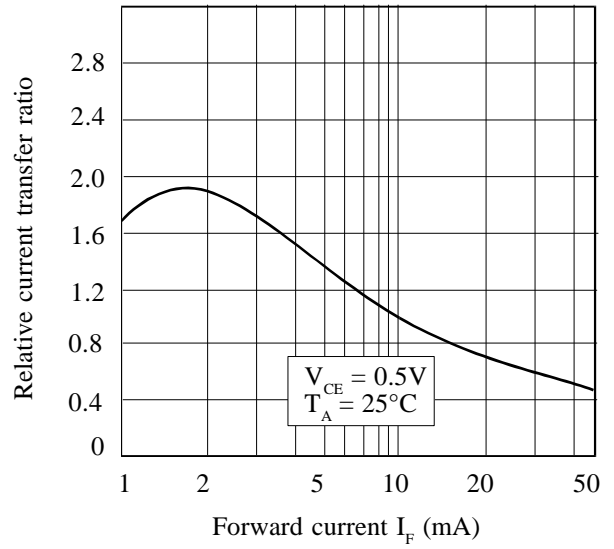

**FIG 1**

**Collector Power Dissipation vs. Ambient Temperature**



**Relative Current Transfer Ratio vs. Forward Current**



**Forward Current vs. Ambient Temperature**

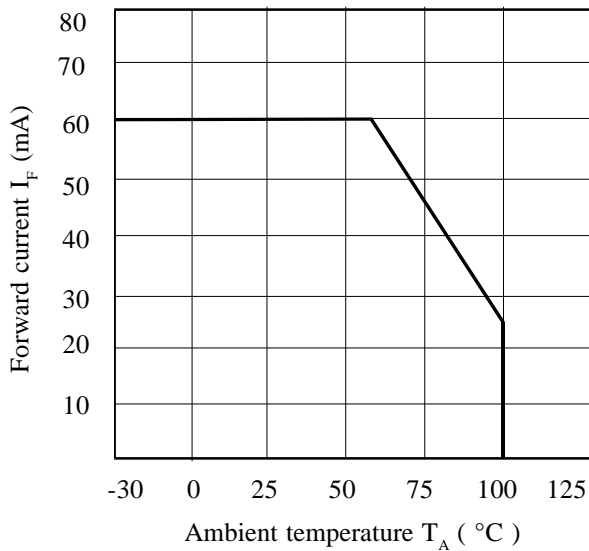

**Relative Current Transfer Ratio vs. Forward Current**

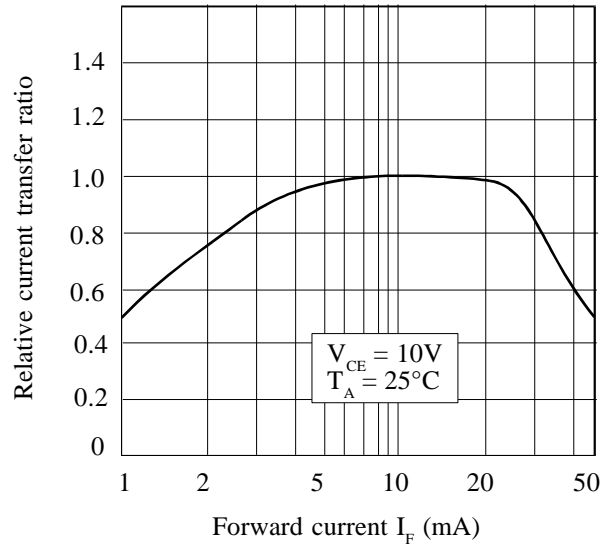

**Relative Current Transfer Ratio vs. Ambient Temperature**

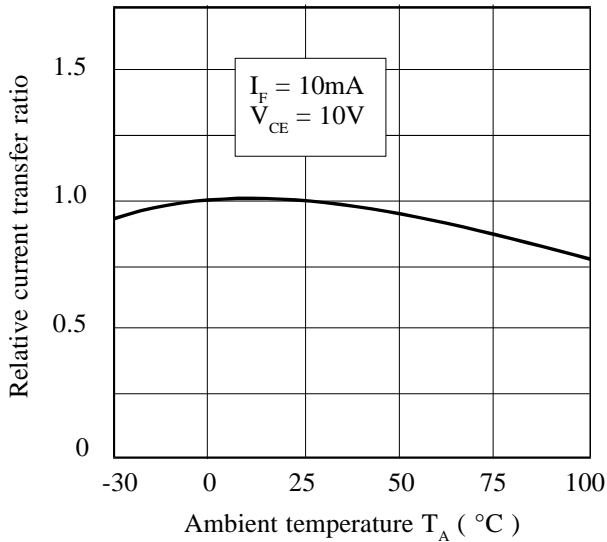

**Collector-emitter Saturation Voltage vs. Ambient Temperature**

