



RAYSTAR

曜凌光電股份有限公司

住址: 42878 台中市大雅区科雅路 25 號 5F WEB: <http://www.Raystar-Optronics.com>
5F., No.25, Keya Rd., Daya Dist., Taichung E-mail: sales@raystar-optronics.com
City 428, Taiwan Tel:886-4-2565-0761 Fax : 886-4-2565-0760

RFK1010G-AAW-LNG

SPECIFICATION

CUSTOMER:

APPROVED BY	
PCB VERSION	
DATE	

FOR CUSTOMER USE ONLY

SALES BY	APPROVED BY	CHECKED BY	PREPARED BY

Release DATE:

Revision History

VERSION	DATE	REVISED PAGE NO.	Note
0	2016/09/13		First issue

Contents

1. Module Classification Information
2. Summary
3. General Specification
4. Interface
5. Contour Drawing
6. Absolute Maximum Ratings
7. Electrical Characteristics
8. Interface Timing Characteristics
9. Optical Characteristics
10. Reliability
11. Touch Panel Information
12. Other

1.Module Classification Information

R	F	K	101	0G	-	A	A	W	-	L	N	G
1	2	3	4	5	-	6	7	8	-	9	10	11

Item	Description	
1	R : Raystar Optronics Inc.	
2	Display Type : F→TFT Type, J→ Custom TFT	
3	Solution: A: 128x160 B:320x234 C:320x240 D:480x234 E:480x272 F:800x480 G:640x480 H:1024x600 I:320x480 J:240x320 K:1280x800 L:240x400 M:1024x768 N:128x128 O:480x800 P:640x320 Q:800x600 S:480x128 T:800x320	
4	Display Size : 10.1" TFT	
5	Version Code.	
6	Model Type: A : TFT LCD E : TFT+FR+CONTROL BOARD J : TFT+FR+A/D BOARD N : TFT+FR+A/D BOARD+CONTROL BOARD S : TFT+FR+POWER BOARD (DC TO DC) 1 : TFT+CONTROL BOARD	6 : TFT+FR H : TFT+D/V BOARD I : TFT+FR+D/V BOARD B : TFT+POWER BD
7	Polarizer Type, Temperature range, View direction	I→Transmissive, W. T, 6:00 ; C→Transmissive, N. T, 6:00 L→Transmissive, W.T,12:00 ; F→Transmissive, N.T,12:00 Y→Transmissive,W.T, IPS TFT ; A→Transmissive, N.T, IPS TFT Z→Transmissive, W.T, O-TFT R→Transmissive, Super W.T, O-TFT N→Transmissive, Super W.T, 6:00; Q→Transmissive, Super W.T, 12:00 V→Transmissive, Super W.T, VA TFT
8	Backlight	W : LED, White H : LED, High Light White F : CCFL, White
9	Driver Method	D: Digital A: Analog L : LVDS M:MIPI
10	Interface	N : without control board A : 8Bit B : 16Bit S:SPI Interface R: RS232 U:USB I: I2C
11	TS	N : Without TS S : resistive touch panel C : capacitive touch panel capacitive touch panel (G-F-F) G : capacitive touch panel(G-G)

2.Summary

This technical specification applies to 10.1' color TFT-LCD panel. The 10.1' color TFT-LCD panel is designed for camcorder, digital camera application and other electronic products which require high quality flat panel displays. This module follows RoHS.

3.General Specifications

- Screen Diagonal: 10.1 inch
- Number of Pixels: 1280 x 3(RGB) x 800 dots
- Module dimension: 257.96 x 168.6 x 5.575 mm
- Active area: 216.96 (H) x 135.6(V) mm
- Pixel pitch: 0.1695 × 0.1695 mm
- Display Mode: Normally Black
- Pixel Arrangement: R.G.B. Vertical Stripe
- Backlight Type: LED, Normally White
- CTP FW Version: 50
- Electrical Interface (Logic): LVDS
- With /Without TP: With CTP
- Surface: Glare

*Color tone slight changed by temperature and driving voltage.

4.Interface

4.1. Interface Connector

A 40pin connector is used for the module electronics interface. The recommended model is F62240-H1210B manufactured by Vigorconn.

Pin No.	Symbol	I/O	Function	Remark
1	VCOM	P	Common Voltage	
2	VDD	P	Power Supply	
3	VDD	P	Power Supply	
4	NC	-	No connection	
5	NC	-	No connection	
6	NC	-	No connection	
7	GND	P	Ground	
8	Rxin0-	I	-LVDS Differential Data Input	R0-R5,G0
9	Rxin0+	I	+LVDS Differential Data Input	
10	GND	P	Ground	
11	Rxin1-	I	-LVDS Differential Data Input	G1G5,B0,B1
12	Rxin1+	I	+LVDS Differential Data Input	
13	GND	P	Ground	
14	Rxin2-	I	-LVDS Differential Data Input	B2-B5,HS,VS, DE
15	Rxin2+	I	+LVDS Differential Data Input	
16	GND	P	Ground	
17	RxCLK-	I	-LVDS Differential Clock Input	LVDS CLK
18	RxCLK+	I	+LVDS Differential Clock Input	
19	GND	P	Ground	
20	Rxin3-	I	-LVDS Differential Data Input	R6,R7,G6,G7, B6,B7
21	Rxin3+	I	+LVDS Differential Data Input	
22	GND	P	Ground	
23	NC	-	No connection	
24	NC	-	No connection	
25	GND	P	Ground	
26	NC	-	No connection	
27	LED_PWM	O	CABC controller signal output for backlight	Note2
28	NC	-	No connection	
29	AVDD	P	No connection	

30	GND	P	Ground	
31	LED-	P	LED Cathode	
32	LED+	P	LED Cathode	
33	NC	-	No connection	
34	NC	-	No connection	
35	VGL	P	Gate OFF Voltage	
36	NC	-	No connection	
37	CABC_EN	I	CABC Enable Input	Note1
38	VGH	P	Gate ON Voltage	
39	LED+	P	LED Anode	
40	LED+	P	LED Anode	

I: input, O: output, P: Power

Note1: The setting of CABC function are as follows.

Pin	Enable	Disable
CABC_EN	High Voltage	Low Voltage or open

Note2: LED_PWM is used to adjust backlight brightness.



4.2. CTP PIN Definition

Pin	Symbol	Function	Remark
1	SDA	I2C data input and output	
2	SCL	I2C clock input	
3	/RST	External Reset, Low is active	
4	/INT	External interrupt to the host	
5	VDDT	Power Supply : +3.3V	
6	VSS	Ground for analog circuit	

5. Contour Drawing

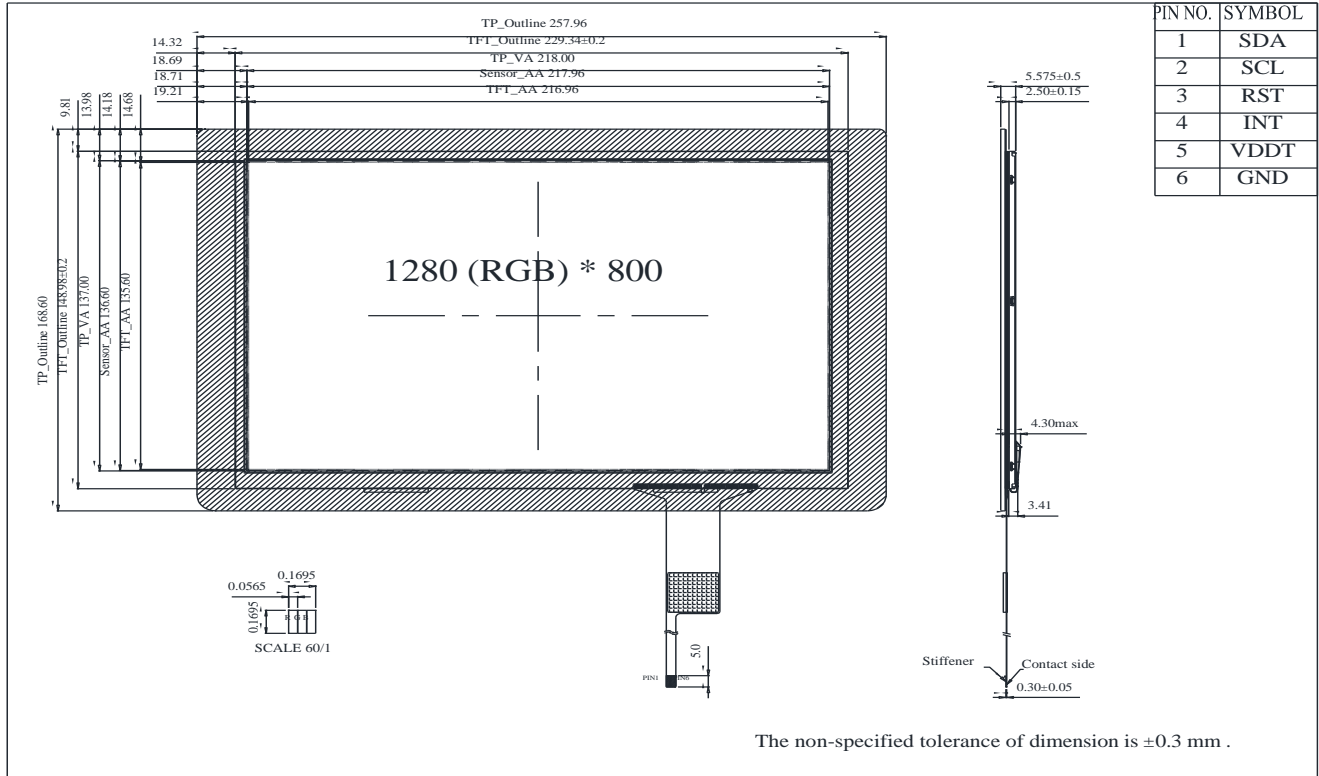

PIN NO.	SYMBOL	PIN NO.	SYMBOL
1	VCOM	21	Rxin3+
2	VDD	22	GND
3	VDD	23	NC
4	NC	24	NC
5	NC	25	GND
6	NC	26	NC
7	GND	27	LED_PWM
8	Rxin0-	28	NC
9	Rxin0+	29	AVDD
10	GND	30	GND
11	Rxin1-	31	LED-
12	Rxin1+	32	LED-
13	GND	33	NC
14	Rxin2-	34	NC
15	Rxin2+	35	VGL
16	GND	36	NC
17	RxCLK-	37	CABC_EN
18	RxCLK+	38	VGH
19	GND	39	LED+
20	Rxin3-	40	LED+

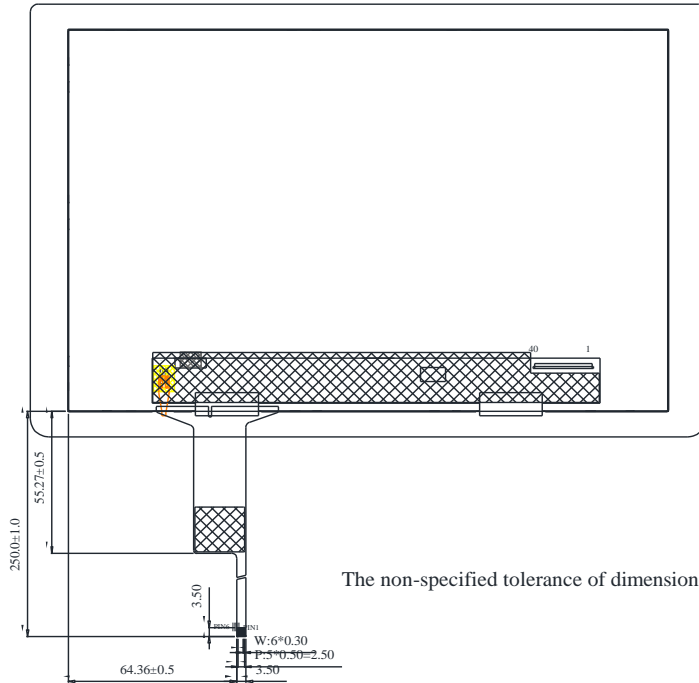

6. Absolute Maximum Ratings

Item	Symbol	Min	Typ	Max	Unit
Operating Temperature	TOP	0	—	+50	°C
Storage Temperature	TST	-20	—	+60	°C

Note: Device is subject to be damaged permanently if stresses beyond those absolute maximum ratings listed above

1. Temp. $\leq 60^{\circ}\text{C}$, 90% RH MAX. Temp. $> 60^{\circ}\text{C}$, Absolute humidity shall be less than 90% RH at 60°C

7. Electrical Characteristics

7.1. Typical Operation Conditions

(Note 1)

Item	Symbol	Values			Unit	Remark
		Min.	Typ.	MAX.		
Power voltage	VDD	2.3	2.5	2.7	V	Note 2
	VDDT	2.8	—	3.3	V	
	AVDD	8.0	8.2	8.4	V	
	VGH	21.7	22	22.3	V	
	VGL	-7.3	-7	-6.7	V	
Input signal voltage	TOP	2.7	3.0	3.3	V	Note 4
Input logic high voltage	TST	0.8VDD	-	3.6	V	Note 3
Input logic low voltage		0	-	0.2VDD	V	

Note 1: Be sure to apply VDD and VGL to the LCD first, and then apply VGH.

Note 2: VDD setting should match the signals output voltage (refer to Note 3) of customer's system board.

Note 4: Typical VCOM is only a reference value, it must be optimized according to each LCM. Be sure to use VR.

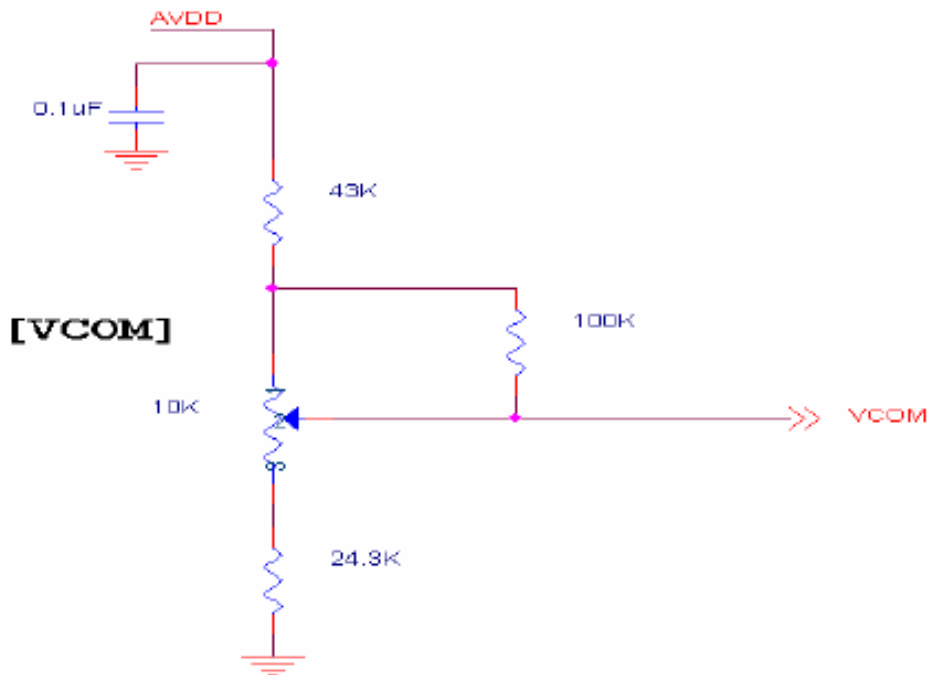

7.2. Current Consumption

Item	Symbol	Values			Unit	Remark
		Min.	Typ.	MAX.		
Current for Driver	IGH	-	705	750	uA	VGH =22V
	IGL	-	705	750	uA	VGL = -7V
	IVDD	-	95	120	mA	VDD =2.5V
	IAVDD	-	45	70	mA	AVDD=8.2V

7.3. Power Sequence

a. Power on:

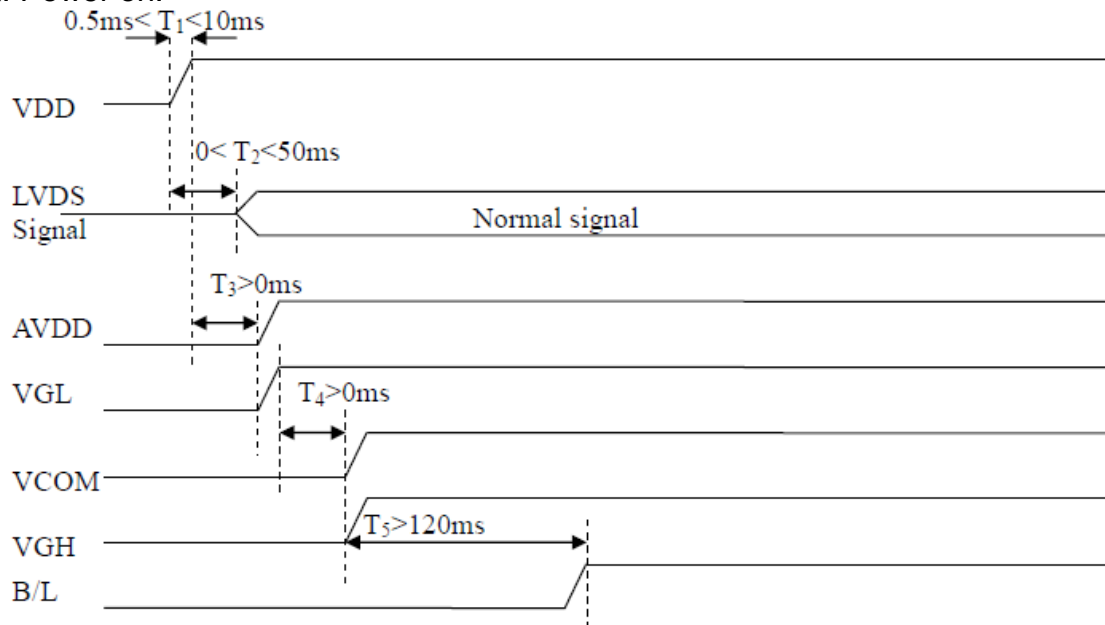

b. Power off:

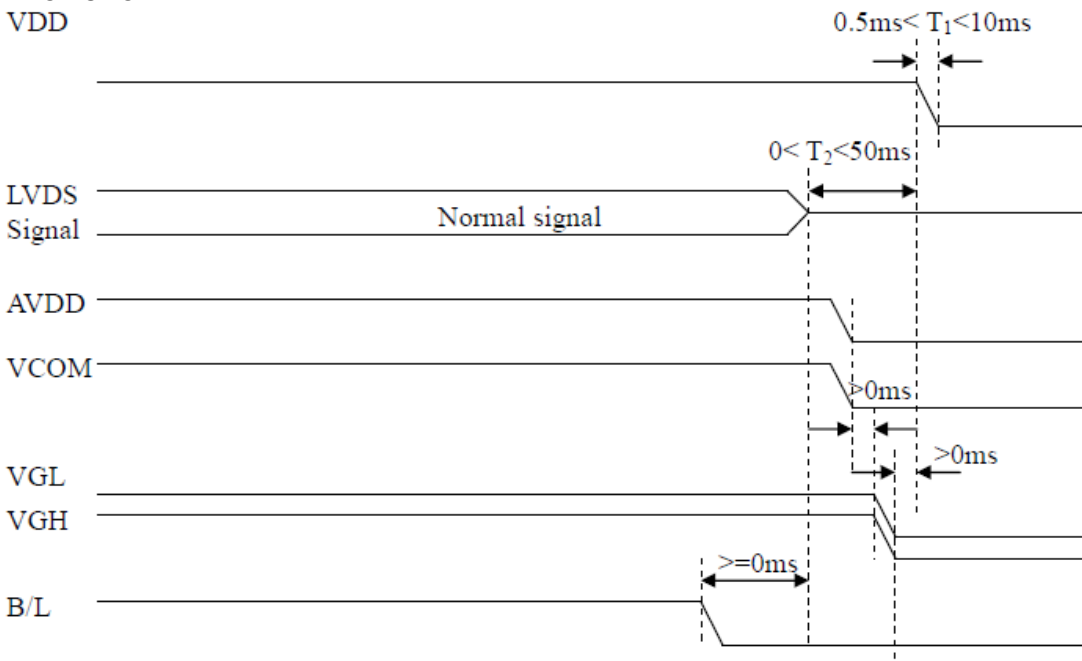

7.4. Backlight Characteristics

Parameter	Symbol	Min.	Typ.	Max.	Unit	Remark
Supply voltage of white LED backlight	VL	8.6	9.6	10.2	V	Note 1
Current for LED backlight	IL	—	220	—	mA	
LED life time	-	50000	-	-	Hr	Note 1

Note 1 : There are 1 Groups LED

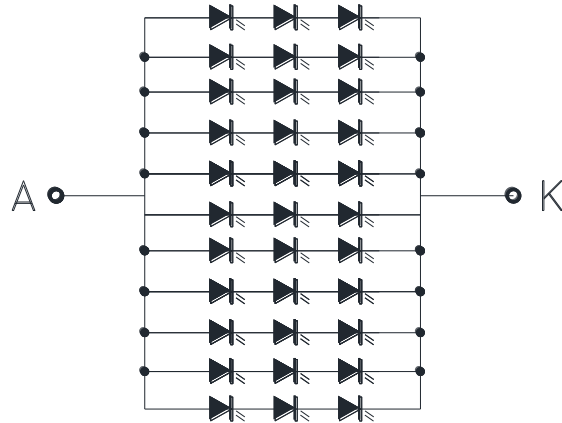

Note 2 : $T_a = 25\text{ }^\circ\text{C}$

Note 3 : Brightness to be decreased to 50% of the initial value

Note 4 : The single LED lamp case

8.LVDS Signal Timing Characteristics

8.1. AC Electrical Characteristics

Parameter	Symbol	Values			Unit	Remark
		Min.	Typ.	MAX.		
LVDS Differential input high Threshold voltage	RxVTH	-	-	+100	mV	RXVCM=1.2 V
LVDS Differential input low Threshold voltage	RxVTL	-100	-	-	mV	
LVDS Differential input common mode voltage	RxVCM	0.7	-	1.6	V	
LVDS Differential voltage	VID	200	-	600	mV	

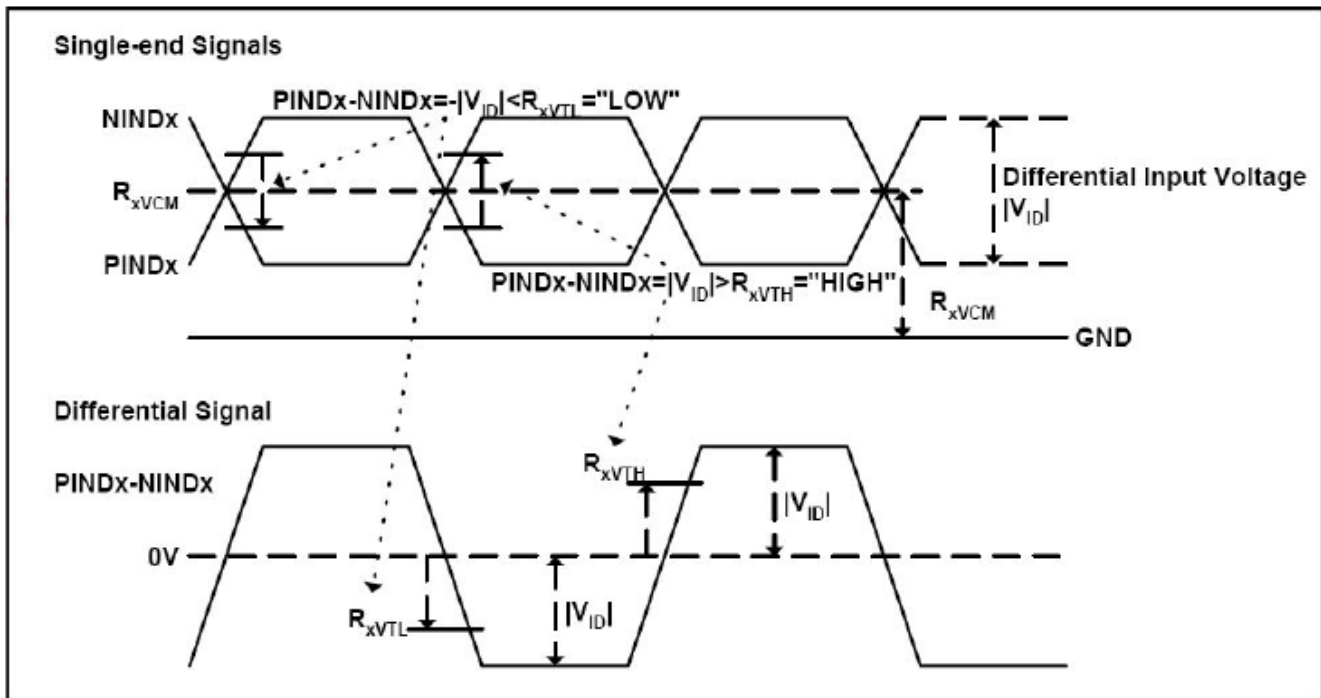

8.2. Timing Table

Parameter	Symbol	Value			Unit	Remark
		Min.	Typ.	Max.		
Clock Frequency	1/Tc	68.9	71.1	73.4	Mhz	Frame rate =60Hz
Horizontal display area	thd	1280			Tc	
HS period time	th	1410	1440	1470	Tc	
HS Width +Back Porch +Front Porch	t _{HW} + t _{HBP} +t _{HFP}	60	160	190	Tc	
Vertical display area	tvd	800			tH	
VS period time	tv	815	823	833	tH	
VS Width +Back Porch +Front Porch	t _{VW} + t _{VBP} +t _{VFP}	15	23	33	tH	

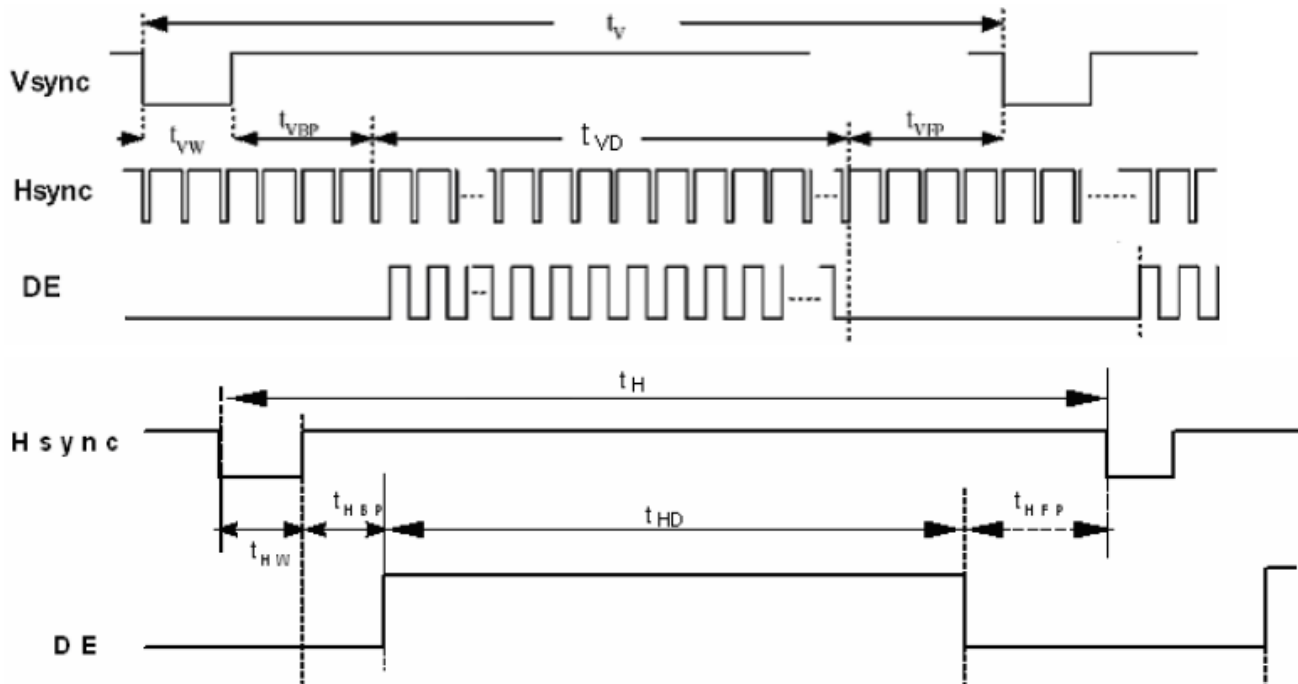

8.3. LVDS Data Input Format

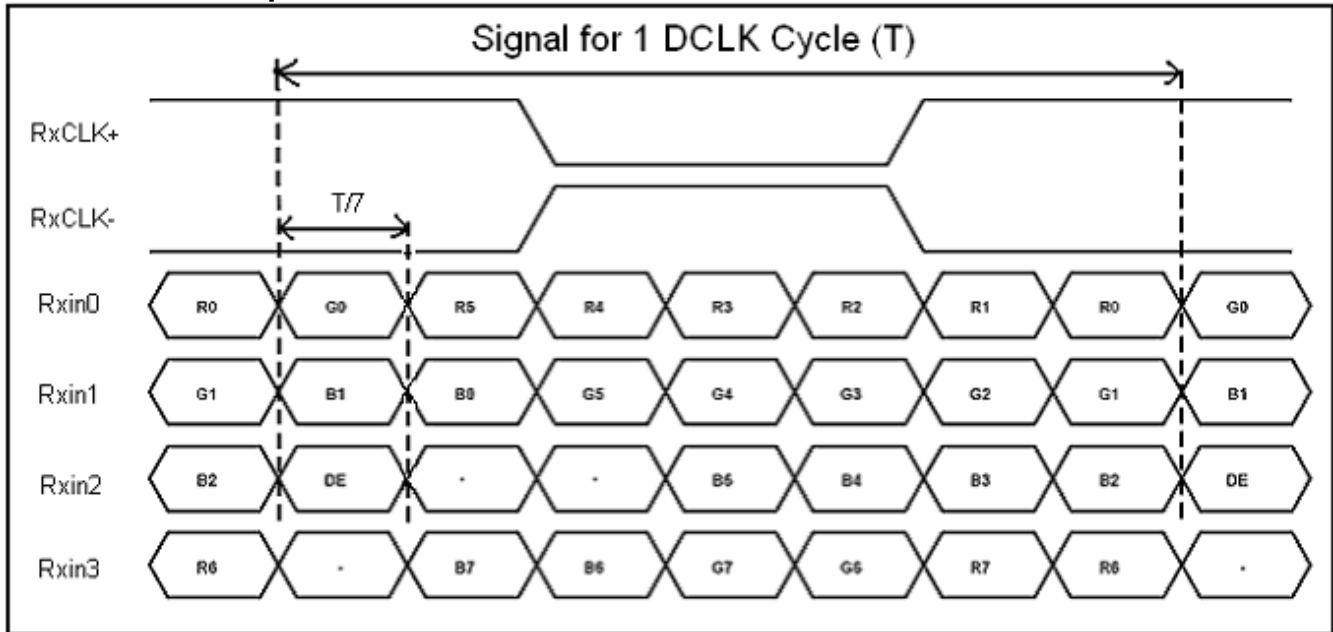

9. Optical Characteristics

Item	Symbol	Condition.	Min	Typ.	Max.	Unit	Remark	
Response time	T_r	$\theta=0^\circ, \Phi=0^\circ$	-	10	20	.ms	Note 3	
	T_f		-	15	30			
Contrast ratio	CR	At optimized viewing angle	600	800	-	-	Note 4	
Color Chromaticity	White	$\theta=0^\circ, \Phi=0^\circ$	W_x	0.26	0.31	0.36	-	Note 2,5
	W_y		0.28	0.33	0.38	-		
Viewing angle (Gray Scale Inversion Direction)	Hor.	$CR \geq 10$	θ_R	75	85	-	Deg.	Note 1
			θ_L	75	85	-		
	Ver.		Φ_T	75	85	-		
			Φ_B	75	85	-		
Brightness	-	-	300	-	-	cd/m ²	Center of display	

Ta=25±2°C

Note 1: Definition of viewing angle range

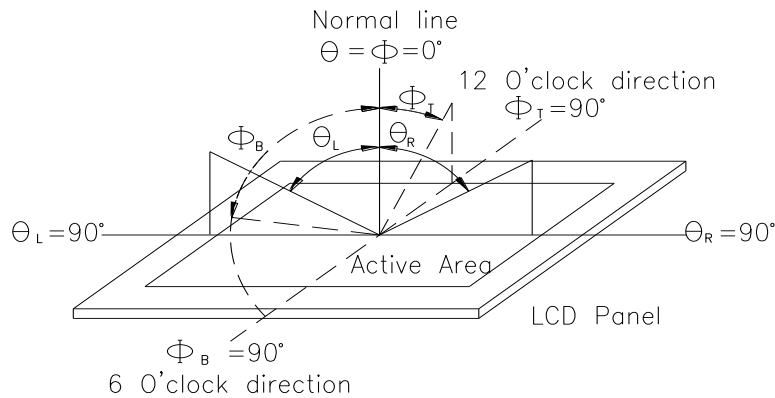

Fig. 9.1. Definition of viewing angle

Note 2: Test equipment setup:

After stabilizing and leaving the panel alone at a driven temperature for 10 minutes, the measurement should be executed. Measurement should be executed in a stable, windless, and dark room. Optical specifications are measured by Topcon BM-7 or BM-5 luminance meter 1.0° field of view at a distance of 50cm and normal direction.

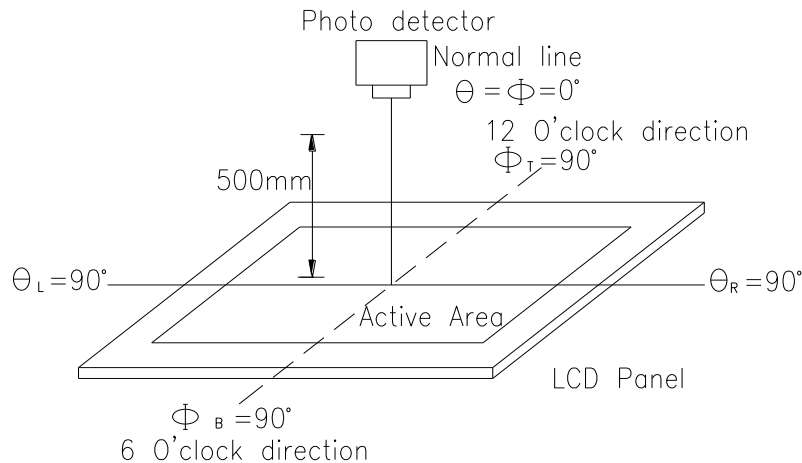
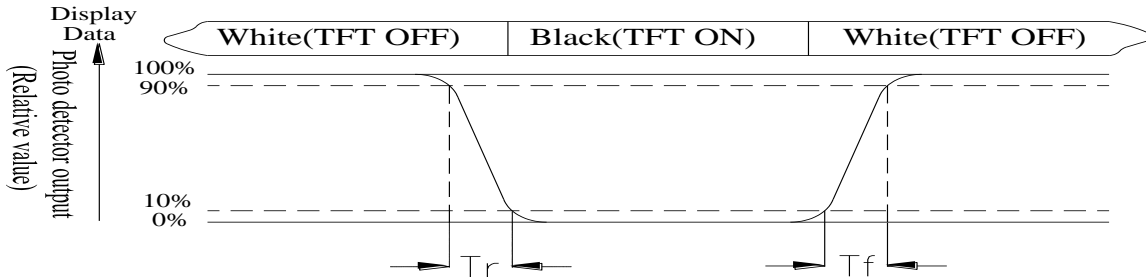

Fig. 9.2. Optical measurement system setup

Note 3: Definition of Response time:

The response time is defined as the LCD optical switching time interval between “White” state and “Black” state. Rise time, T_r , is the time between photo detector output intensity changed from 90% to 10%. And fall time, T_f , is the time between photo detector output intensity changed from 10% to 90%



Note 4: Definition of contrast ratio:

The contrast ratio is defined as the following expression.

$$\text{Contrast ratio (CR)} = \frac{\text{Luminance measured when LCD on the "White" state}}{\text{Luminance measured when LCD on the "Black" state}}$$

Note 5: White $V_i = V_{i50} \pm 1.5V$

Black $V_i = V_{i50} \pm 2.0V$

“±” means that the analog input signal swings in phase with VCOM signal.

“±” means that the analog input signal swings out of phase with VCOM signal.

The 100% transmission is defined as the transmission of LCD panel when all the input terminals of module are electrically opened.

Note 6: Definition of color chromaticity (CIE 1931)

Color coordinates measured at the center point of LCD

Note 7: Measured at the center area of the panel when all the input terminals of LCD panel are electrically opened.

10. Reliability

Content of Reliability Test (Wide temperature, 0°C~50°C)

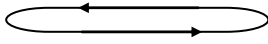
Environmental Test			
Test Item	Content of Test	Test Condition	Note
High Temperature storage	Endurance test applying the high storage temperature for a long time.	60°C 200hrs	2
Low Temperature storage	Endurance test applying the low storage temperature for a long time.	-20°C 200hrs	1,2
High Temperature Operation	Endurance test applying the electric stress (Voltage & Current) and the thermal stress to the element for a long time.	50°C 200hrs	—
Low Temperature Operation	Endurance test applying the electric stress under low temperature for a long time.	0°C 200hrs	1
High Temperature/ Humidity Operation	The module should be allowed to stand at 60 °C, 90%RH max	60°C, 90%RH 96hrs	1,2
Thermal shock resistance	<p>The sample should be allowed stand the following 10 cycles of operation</p> <p style="text-align: center;"> 0°C 25°C 50°C  30min 5min 30min 1 cycle </p>	0°C/50°C 10 cycles	—
Vibration test	Endurance test applying the vibration during transportation and using.	Total fixed amplitude : 1.5mm Vibration Frequency : 10~55Hz One cycle 60 seconds to 3 directions of X,Y,Z for Each 15 minutes	3
Static electricity test	Endurance test applying the electric stress to the terminal.	VS=±600V(contact), ±800v(air), RS=330Ω CS=150pF 10 times	—

Note1: No dew condensation to be observed.

Note2: The function test shall be conducted after 4 hours storage at the normal Temperature and humidity after remove from the test chamber.

Note3: The packing have to including into the vibration testing.

11.Touch Panel Information

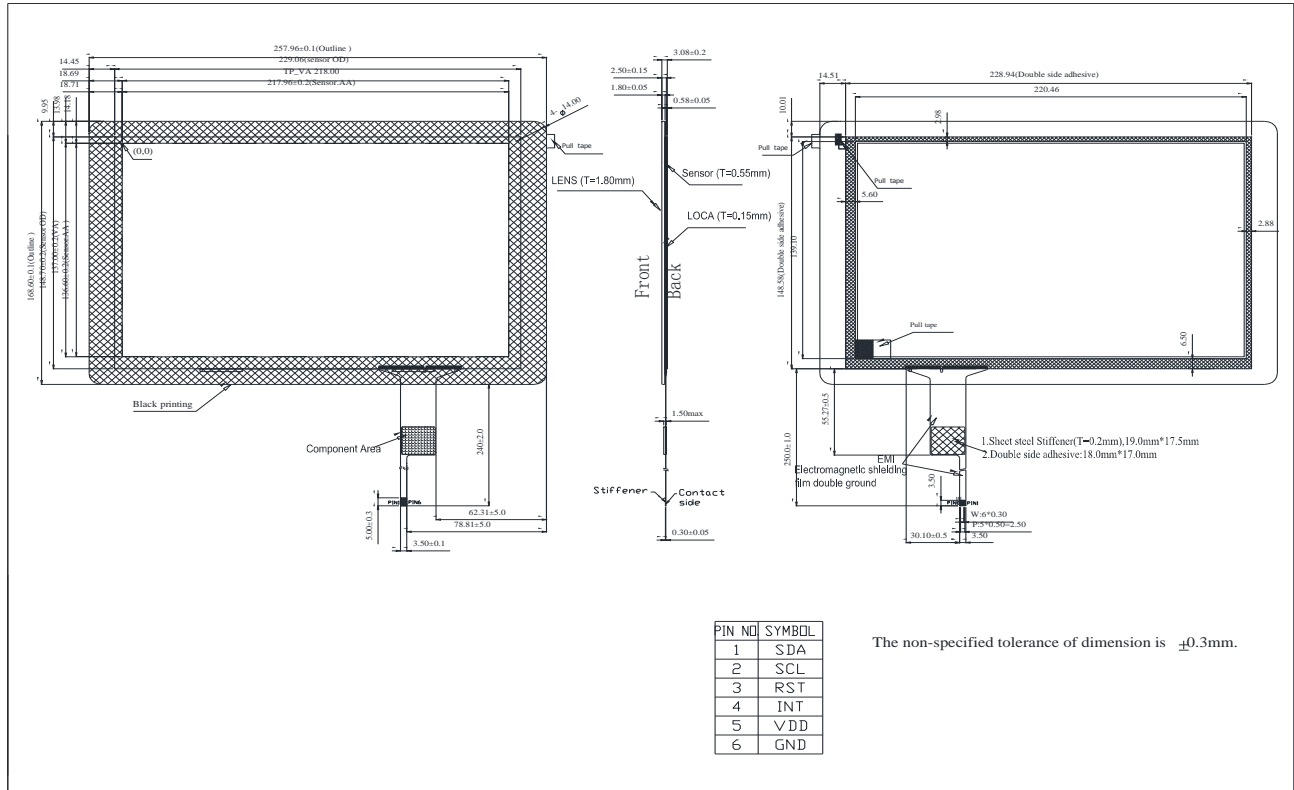

11.1. Timing for Read Operation

First, set address pointer based on the aforesaid Write Operation timing sequence. Then, resend

Start condition to perform Read addressing and read data in the registers.



Address_R: Slave address with Read control bit.

NACK: Host issues NACK after reading the last byte.

After setting Read addresses, the host can read one or more than one byte at a time. GT9110 will automatically increase the address pointer and send subsequent data in sequence.

The Stop condition (the first E signal as shown in the above diagram) after setting the address pointer is optional. However, the repeated Start condition has to be sent.

11.2. Coordinate registers

Addr	Access	bit7	bit6	bit5	bit4	bit3	bit2	bit1	bit0
0x8140	R	Product ID(first Byte, ASCII)							
0x8141	R	Product ID(second Byte, ASCII)							
0x8142	R	Product ID(third Byte, ASCII)							
0x8143	R	Product ID(forth Byte, ASCII)							
0x8144	R	Firmware version(HEX.low byte)							
0x8145	R	Firmware version (HEX.high byte)							
0x8146	R	x coordinate resolution (low byte)							
0x8147	R	x coordinate resolution (high byte)							
0x8148	R	y coordinate resolution (low byte)							
0x8149	R	y coordinate resolution (high byte)							

0x814A	R	Vendor_id(ID of the current module)				
0x814B	R	Reserved				
0x814C	R	Reserved				
0x814D	R	Reserved				
0x814E	R/W	buffer status	large detect	Reserved	HaveKey	number of touch points
0x814F	R	track id as 32 indicates HotKnot proximity detection signal				
0x8150	R	PxyOk	Reserved			
0x8151	R	PxyOk	Reserved			
0x8152	R	Reserved				
0x8153	R	Reserved				
0x8154	R	Reserved				
0x8155	R	Reserved				
0x8156	R	Reserved				
0x8157	R	pen_sta	Reserved			track id
0x8158	R	point 1 x coordinate (low byte)				
0x8159	R	point 1 x coordinate (high byte)				
0x815A	R	point 1 y coordinate (low byte)				
0x815B	R	point 1 y coordinate (high byte)				
0x815C	R	Point 1 size (low byte)				
0x815D	R	point 1 size (high byte)				
0x815E	R	Reserved				
0x815F	R	track id				
0x8160	R	point 2 x coordinate (low byte)				
0x8161	R	point 2 x coordinate (high byte)				
0x8162	R	point 2 y coordinate (low byte)				
0x8163	R	point 2 y coordinate (high byte)				
0x8164	R	point 2 size (low byte)				
0x8165	R	point 2 size (high byte)				
0x8166	R	Reserved				
0x8167	R	track id				
0x8168	R	point 3 x coordinate (low byte)				
0x8169	R	point 3 x coordinate (high byte)				
0x816A	R	point 3 y coordinate (low byte)				
0x816B	R	point 3 y coordinate (high byte)				
0x816C	R	point 3 size (low byte)				
0x816D	R	point 3 size (high byte)				
0x816E	R	Reserved				
0x816F	R	track id				
0x8170	R	point 4 x coordinate (low byte)				
0x8171	R	point 4 x coordinate (high byte)				
0x8172	R	point 4 y coordinate (low byte)				

0x8173	R	point 4 y coordinate (high byte)
0x8174	R	point 4 size (low byte)
0x8175	R	point 4 size (high byte)
0x8176	R	Reserved
0x8177	R	track id
0x8178	R	point 5 x coordinate (low byte)
0x8179	R	point 5 x coordinate (high byte)
0x817A	R	point 5 y coordinate (low byte)
0x817B	R	point 5 y coordinate (high byte)
0x817C	R	point 5 size (low byte)
0x817D	R	point 5 size (high byte)
0x817E	R	Reserved
0x817F	R	track id
0x8180	R	point 6 x coordinate (low byte)
0x8181	R	point 6 x coordinate (high byte)
0x8182	R	point 6 y coordinate (low byte)
0x8183	R	point 6 y coordinate (high byte)
0x8184	R	point 6 size (low byte)
0x8185	R	point 6 size (high byte)
0x8186	R	Reserved
0x8187	R	track id
0x8188	R	point 7 x coordinate (low byte)
0x8189	R	point 7 x coordinate (high byte)
0x818A	R	point 7 y coordinate (low byte)
0x818B	R	point 7 y coordinate (high byte)
0x818C	R	point 7 size (low byte)
0x818D	R	point 7 size (high byte)
0x818E	R	Reserved
0x818F	R	track id
0x8190	R	point 8 x coordinate (low byte)
0x8191	R	point 8 x coordinate (high byte)
0x8192	R	point 8 y coordinate (low byte)
0x8193	R	point 8 y coordinate (high byte)
0x8194	R	point 8 size (low byte)
0x8195	R	point 8 size (high byte)
0x8196	R	Reserved
0x8197	R	track id
0x8198	R	point 9 x coordinate (low byte)
0x8199	R	point 9 x coordinate (high byte)
0x819A	R	point 9 y coordinate (low byte)
0x819B	R	point 9 y coordinate (high byte)

0x819C	R	point 9 size (low byte)
0x819D	R	point 9 size (high byte)
0x819E	R	Reserved
0x819F	R	track id
0x81A0	R	point 10 x coordinate (low byte)
0x81A1	R	point 10 x coordinate (high byte)
0x81A2	R	point 10 y coordinate (low byte)
0x81A3	R	point 10 y coordinate (high byte)
0x81A4	R	point 10 size (low byte)
0x81A5	R	point 10 size (high byte)
0x81A6	R	Reserved
0x81A7	R	KeyValue

11.3. I2C protocol

3.3V ,400BPS ,pull high 2K ohm

Parameter	Symbol	Min.	Max.	Unit
SCL low period	t_{lo}	0.9	-	US
SCL high period	t_{hi}	0.8	-	US
SCL setup time for START condition	t_{st1}	0.4	-	US
SCL setup time for STOP condition	t_{st3}	0.4	-	US
SCL hold time for START condition	t_{hd1}	0.3	-	US
SDA setup time	t_{st2}	0.4	-	US
SDA hold time	t_{hd2}	0.4	-	US

LCM Sample Estimate Feedback Sheet		
Module Number : _____		
1 、 <u>Panel Specification</u> :		
1. Panel Type :	<input type="checkbox"/> Pass	<input type="checkbox"/> NG , _____
2. View Direction :	<input type="checkbox"/> Pass	<input type="checkbox"/> NG , _____
3. Numbers of Dots :	<input type="checkbox"/> Pass	<input type="checkbox"/> NG , _____
4. View Area :	<input type="checkbox"/> Pass	<input type="checkbox"/> NG , _____
5. Active Area :	<input type="checkbox"/> Pass	<input type="checkbox"/> NG , _____
6. Operating Temperature :	<input type="checkbox"/> Pass	<input type="checkbox"/> NG , _____
7. Storage Temperature :	<input type="checkbox"/> Pass	<input type="checkbox"/> NG , _____
8. Others : _____		
2 、 <u>Mechanical Specification</u> :		
1. PCB Size :	<input type="checkbox"/> Pass	<input type="checkbox"/> NG , _____
2. Frame Size :	<input type="checkbox"/> Pass	<input type="checkbox"/> NG , _____
3. Material of Frame :	<input type="checkbox"/> Pass	<input type="checkbox"/> NG , _____
4. Connector Position :	<input type="checkbox"/> Pass	<input type="checkbox"/> NG , _____
5. Fix Hole Position :	<input type="checkbox"/> Pass	<input type="checkbox"/> NG , _____
6. Backlight Position :	<input type="checkbox"/> Pass	<input type="checkbox"/> NG , _____
7. Thickness of PCB :	<input type="checkbox"/> Pass	<input type="checkbox"/> NG , _____
8. Height of Frame to PCB :	<input type="checkbox"/> Pass	<input type="checkbox"/> NG , _____
9. Height of Module :	<input type="checkbox"/> Pass	<input type="checkbox"/> NG , _____
10. Others :	<input type="checkbox"/> Pass	<input type="checkbox"/> NG , _____
3 、 <u>Relative Hole Size</u> :		
1. Pitch of Connector :	<input type="checkbox"/> Pass	<input type="checkbox"/> NG , _____
2. Hole size of Connector :	<input type="checkbox"/> Pass	<input type="checkbox"/> NG , _____
3. Mounting Hole size :	<input type="checkbox"/> Pass	<input type="checkbox"/> NG , _____
4. Mounting Hole Type :	<input type="checkbox"/> Pass	<input type="checkbox"/> NG , _____
5. Others :	<input type="checkbox"/> Pass	<input type="checkbox"/> NG , _____
4 、 <u>Backlight Specification</u> :		
1. B/L Type :	<input type="checkbox"/> Pass	<input type="checkbox"/> NG , _____
2. B/L Color :	<input type="checkbox"/> Pass	<input type="checkbox"/> NG , _____
3. B/L Driving Voltage (Reference for LED Type) : <input type="checkbox"/> Pass <input type="checkbox"/> NG , _____		
4. B/L Driving Current :	<input type="checkbox"/> Pass	<input type="checkbox"/> NG , _____
5. Brightness of B/L :	<input type="checkbox"/> Pass	<input type="checkbox"/> NG , _____
6. B/L Solder Method :	<input type="checkbox"/> Pass	<input type="checkbox"/> NG , _____
7. Others :	<input type="checkbox"/> Pass	<input type="checkbox"/> NG , _____

>> **Go to page 2** <<

Module Number : _____		
5 · <u>Electronic Characteristics of Module</u> :		
1.Input Voltage :	<input type="checkbox"/> Pass	<input type="checkbox"/> NG , _____
2.Supply Current :	<input type="checkbox"/> Pass	<input type="checkbox"/> NG , _____
3.Driving Voltage for LCD :	<input type="checkbox"/> Pass	<input type="checkbox"/> NG , _____
4.Contrast for LCD :	<input type="checkbox"/> Pass	<input type="checkbox"/> NG , _____
5.B/L Driving Method :	<input type="checkbox"/> Pass	<input type="checkbox"/> NG , _____
6.Negative Voltage Output :	<input type="checkbox"/> Pass	<input type="checkbox"/> NG , _____
7.Interface Function :	<input type="checkbox"/> Pass	<input type="checkbox"/> NG , _____
8.LCD Uniformity :	<input type="checkbox"/> Pass	<input type="checkbox"/> NG , _____
9.ESD test :	<input type="checkbox"/> Pass	<input type="checkbox"/> NG , _____
10.Others :	<input type="checkbox"/> Pass	<input type="checkbox"/> NG , _____
6 · <u>Summary</u> :		
<p>Sales signature : _____</p> <p>Customer Signature : _____ Date : / / _____</p>		