



RAYSTAR

曜凌光電股份有限公司

住址: 42878 台中市大雅区科雅路 25 號 5F WEB: <http://www.Raystar-Optronics.com>
5F., No.25, Keya Rd., Daya Dist., Taichung E-mail: sales@raystar-optronics.com
City 428, Taiwan Tel:886-4-2565-0761 Fax : 886-4-2565-0760

RFF50YB-AIW-DNG

SPECIFICATION

CUSTOMER:

APPROVED BY	
PCB VERSION	
DATE	

FOR CUSTOMER USE ONLY

SALES BY	APPROVED BY	CHECKED BY	PREPARED BY

Release DATE:

Revision History

VERSION	DATE	REVISED PAGE NO.	Note
0	2015/09/11		First issue
A	2016/01/07		Modify FPC.
B	2016/01/21		Modify Static electricity test
C	2016/03/21		Modify Brightness

RAYSTAR OPTRONICS

Contents

1. Module Classification Information
2. Summary
3. General Specification
4. Interface
5. Contour Drawing
6. Absolute Maximum Ratings
7. Electrical Characteristics
8. Optical Characteristics
9. Reliability
10. Touch Panel Information
11. Other

1.Module Classification Information

R	F	F	50	YB	-	A	I	W	-	D	N	G
1	2	3	4	5	-	6	7	8	-	9	10	11

Item	Description	
1	R : Raystar Optronics Inc.	
2	Display Type : F→TFT Type, J→ Custom TFT	
3	Solution: A: 128x160 B:320x234 C:320x240 D:480x234 E:480x272 F:800x480 G:640x480 H:1024x600 I:320x480 J:240x320 K:1280x800 L:240x400 M:1024x768 N:128x128 O:480x800 P:640x320 Q:800x600 S:480x128 T:800x320	
4	Display Size : 5.0" TFT	
5	Version Code.	
6	Model Type: A : TFT LCD E : TFT+FR+CONTROL BOARD J : TFT+FR+A/D BOARD N : TFT+FR+A/D BOARD+CONTROL BOARD S : TFT+FR+POWER BOARD (DC TO DC) 1 : TFT+CONTROL BOARD	6 : TFT+FR H : TFT+D/V BOARD I : TFT+FR+D/V BOARD B : TFT+POWER BD
7	Polarizer Type, Temperature range, View direction	I→Transmissive, W. T, 6:00 ; C→Transmissive, N. T, 6:00 L→Transmissive, W.T,12:00 ; F→Transmissive, N.T,12:00 Y→Transmissive,W.T, IPS TFT ; A→Transmissive, N.T, IPS TFT Z→Transmissive, W.T, O-TFT R→Transmissive, Super W.T, O-TFT N→Transmissive, Super W.T, 6:00; Q→Transmissive, Super W.T, 12:00 V→Transmissive, Super W.T, VA TFT
8	Backlight	W : LED, White H : LED, High Light White F : CCFL, White
9	Driver Method	D: Digital A: Analog L : LVDS M:MIPI
10	Interface	N : without control board A : 8Bit B : 16Bit S:SPI Interface R: RS232 U:USB I: I2C
11	TS	N : Without TS S : resistive touch panel C : capacitive touch panel capacitive touch panel (G-F-F) G : capacitive touch panel(G-G)

2.Summary

This technical specification applies to 5.0' color TFT-LCD panel. The 5.0' color TFT-LCD panel is designed for camcorder, digital camera application and other electronic products which require high quality flat panel displays. This module follows RoHS.

RAYSTAR OPTRONICS

3.General Specifications

- Size: 5.0 inch
- Dot Matrix: 800 × 3(RGB) × 480 dots
- Module dimension: 120.7(W) × 75.8(H) × 4.58 (D) mm
- Active area: 108 (W) × 64.8(H) mm
- Dot pitch: 0.045(W) × 0.135(H) mm
- LCD type: TFT, Normally White, Transmissive
- View Direction: 12 o'clock
- Gray Scale Inversion Direction: 6 o'clock
- Backlight Type: LED ,Normally White
- With /Without TP: With CTP
- Surface: Glare

*Color tone slight changed by temperature and driving voltage.

4.Interface

4.1. LCM PIN Definition

FPC connector is used for electronics interface. The recommended model is FH19SC-40S-0.5SH (05) manufactured by HIROSE.

No.	Symbol	I/O	Function
1	VLED-	P	Power for LED backlight cathode
2	VLED+	P	Power for LED backlight anode
3	GND	P	Power ground
4	VDD	P	Power voltage
5	R0	I	Red data (LSB)
6	R1	I	Red data
7	R2	I	Red data
8	R3	I	Red data
9	R4	I	Red data
10	R5	I	Red data
11	R6	I	Red data
12	R7	I	Red data (MSB)
13	G0	I	Green data (LSB)
14	G1	I	Green data
15	G2	I	Green data
16	G3	I	Green data
17	G4	I	Green data
18	G5	I	Green data
19	G6	I	Green data
20	G7	I	Green data (MSB)
21	B0	I	Blue data (LSB)
22	B1	I	Blue data
23	B2	I	Blue data
24	B3	I	Blue data
25	B4	I	Blue data
26	B5	I	Blue data
27	B6	I	Blue data
28	B7	I	Blue data (MSB)
29	GND	P	Power ground
30	DCLK	I	Pixel clock
31	DISP	I	Display on/ off
32	HSYNC	I	Horizontal sync signal
33	VSYNC	I	Vertical sync signal
34	DE	I	Data enable
35	NC	-	No connect

36	GND	P	Power ground
37	NC	-	No connect
38	NC	-	No connect
39	NC	-	No connect
40	NC	-	No connect

Note: I: input, O: output t, P: Power

4.2. CTP PIN Definition

Pin	Symbol	Function	Remark
1	VSS	Ground for analog circuit	
2	VDDT	Power Supply : +3.0V	
3	SCL	I2C clock input	
4	NC	No connect	
5	SDA	I2C data input and output	
6	NC	No connect	
7	/RST	External Reset, Low is active	
8	/WAKE	External interrupt from the host	
9	/INT	External interrupt to the host	
10	VSS	Ground for analog circuit	

5. Contour Drawing

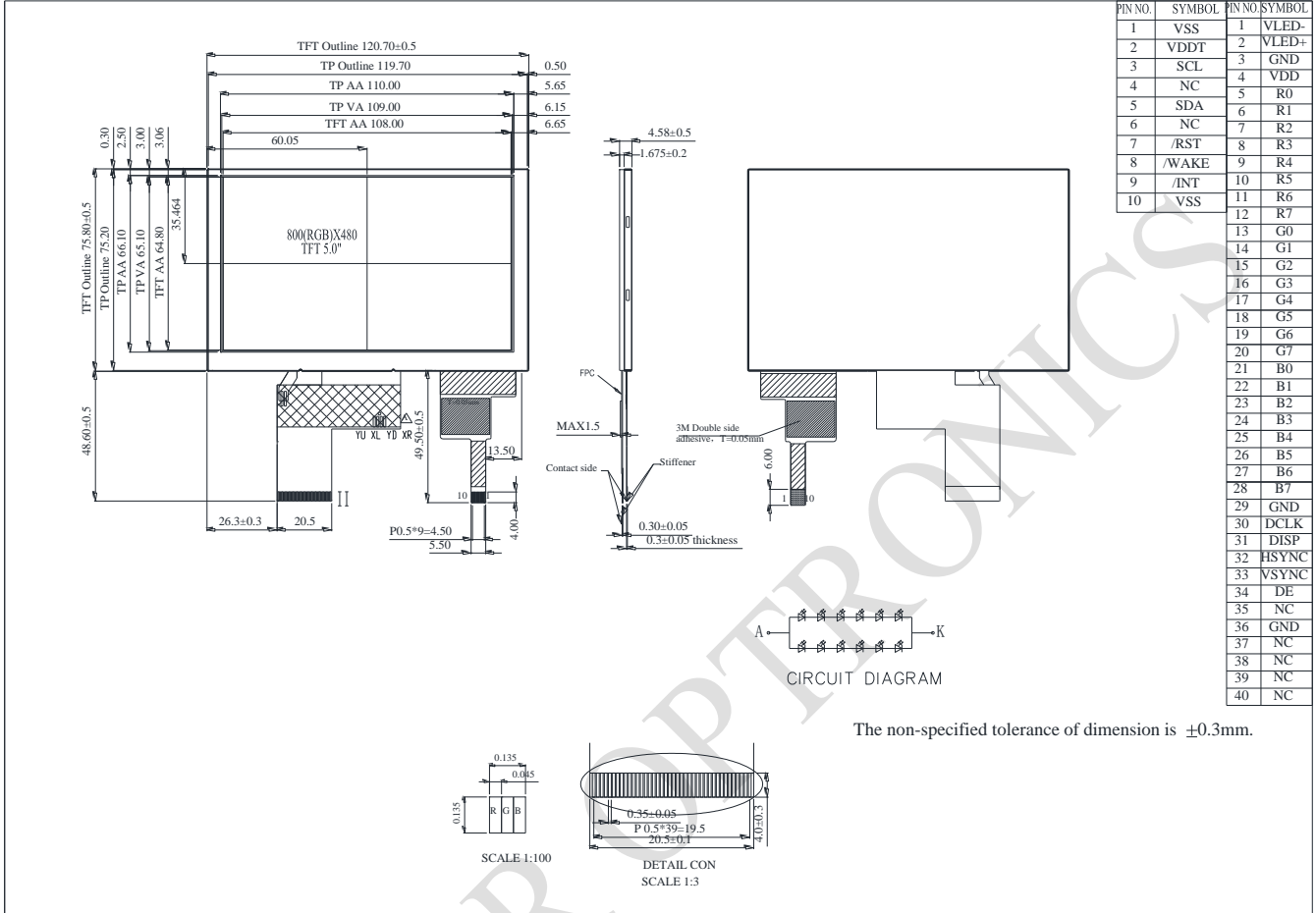

PIN NO.	SYMBOL	PIN NO.	SYMBOL
1	VSS	1	VLED-
2	VDDT	2	VLED+
3	SCL	3	GND
4	NC	4	VDD
5	SDA	5	R0
6	NC	6	R1
7	/RST	7	R2
8	/WAKE	8	R3
9	/INT	9	R4
10	VSS	10	R5
		11	R6
		12	R7
		13	G0
		14	G1
		15	G2
		16	G3
		17	G4
		18	G5
		19	G6
		20	G7
		21	B0
		22	B1
		23	B2
		24	B3
		25	B4
		26	B5
		27	B6
		28	B7
		29	GND
		30	DCLK
		31	DISP
		32	HSYNC
		33	VSYNC
		34	DE
		35	NC
		36	GND
		37	NC
		38	NC
		39	NC
		40	NC

The non-specified tolerance of dimension is ±0.3mm.

6. Absolute Maximum Ratings

Item	Symbol	Min	Typ	Max	Unit
Operating Temperature	TOP	-20	—	+70	°C
Storage Temperature	TST	-30	—	+80	°C

Note: Device is subject to be damaged permanently if stresses beyond those absolute maximum ratings listed above

- Temp. $\leq 60^{\circ}\text{C}$, 90% RH MAX. Temp. $> 60^{\circ}\text{C}$, Absolute humidity shall be less than 90% RH at 60°C

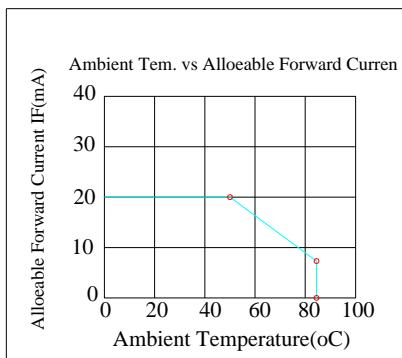

7. Electrical Characteristics

7.1. Typical Operation Conditions

Item	Symbol	Values			Unit	Remark
		Min.	Typ	Max.		
Power voltage	VDD	3.0	3.3	3.6	V	Note 2
Current for Driver	IVDD	-	17	25	mA	
Input logic high voltage	VIH	0.8 VDD	-	VDD	V	Note 3
Input logic low voltage	VIL	0	-	0.2 VDD	V	

7.2. Backlight driving conditions (12 White Chips)

Parameter	Symbol	Min.	Typ.	Max.	Unit	Note
Supply voltage of white LED backlight	VL	17.4	19.8	21	V	Note 1
Curt for LED backlight	IL	30	40	50	mA	
Luminance (on the module surface, BM-7)		400	450	-	cd/m ²	
LED life time	-	20,000	-	-	Hr	Note 2

Note 1: The LED Supply Voltage is defined by the number of LED at Ta=25°C and L =40mA.

Note 2: The “LED life time” is defined as the module brightness decrease to 50% original brightness at Ta=25°C and IL =40mA. The LED lifetime could be decreased if operating IL is larger than 40mA.

LED CIRCUIT

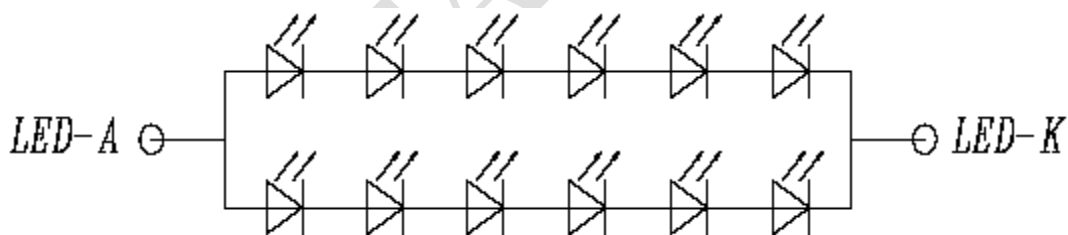

7.3. Power Sequence

To prevent the device damage from latch up, the power ON/OFF sequence shown below must be followed.

Power ON: VDD, DGND_ VDDA, AGND _ V1 to V14

Power OFF: V1 to V14 _ VDDA, AGND_ VDD, DGND

In order to prevent ILI6122 from power ON reset fail, the rising time (tPOR) of the digital power supply VDD should be maintained within given specifications. The power ON/OFF timing sequence is illustrated as below:

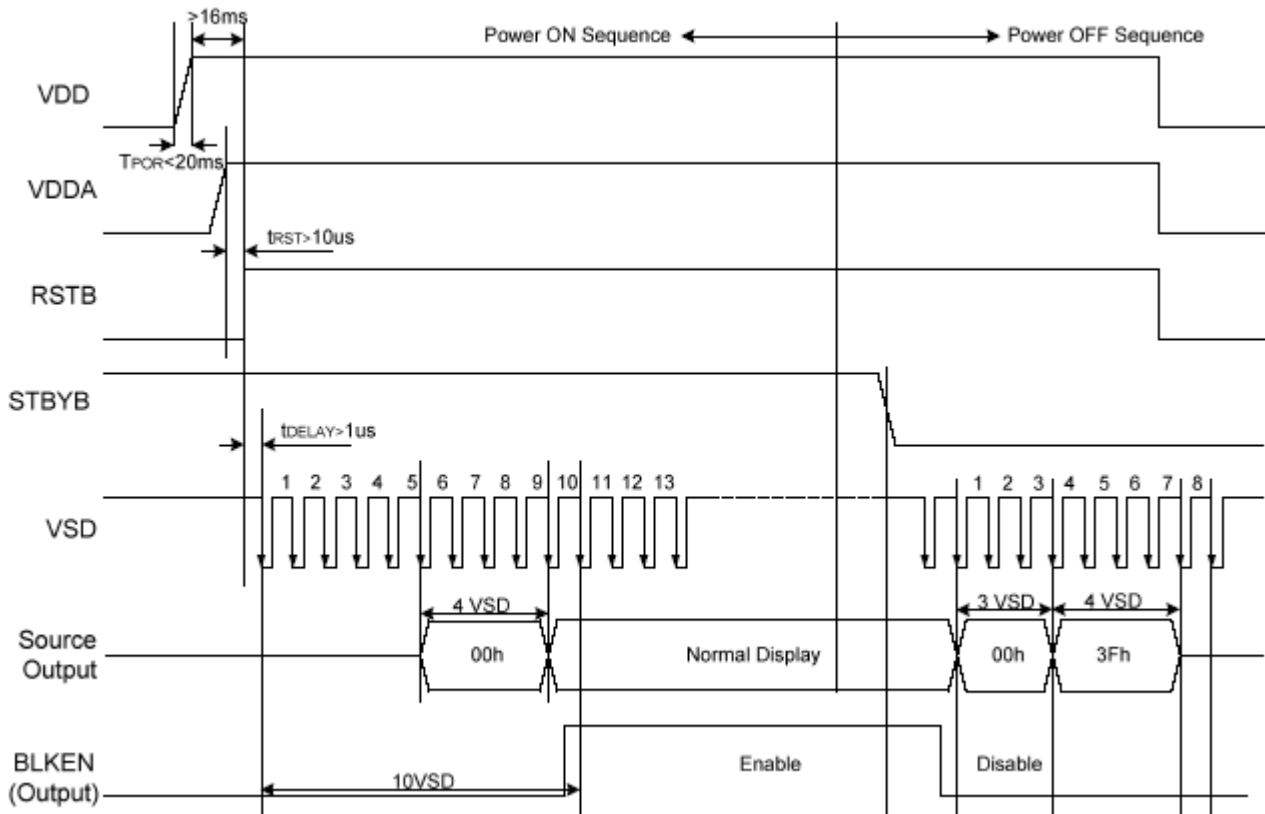

Note: For prevent anormal operation, t_{RST} must be longer than 10us during Power ON sequence.

RAYSTAR

7.4. Timing Characteristic

AC Electrical Characteristics

Parameter	Symbol	Spec			Unit	Conditions
		Min.	Typ.	Max.		
VDD Power ON slew rate	tPOR	--	--	20	ms	0V ~ 0.9VDD
RSTB pulse width	tRST	10	--	--	us	CLKIN=50MHz
CLKIN cycle time	tCPH	20	--	--	ns	
CLKIN pulse duty	tCWH	40	50	60	%	
VSD setup time	tVST	8	--	--	ns	
VSD hold time	tVHD	8	--	--	ns	
HSD setup time	tHST	8	--	--	ns	
HSD hold time	tHHD	8	--	--	ns	
Data setup time	tDST	8	--	--	ns	D0[7:0], D1[7:0], D2[7:0] to CLKIN
Data hold time	tDHD	8	--	--	ns	D0[7:0], D1[7:0], D2[7:0] to CLKIN
DE setup time	tEST	8	--	--	ns	
DE hold time	tEHD	8	--	--	ns	
Output stable time	tSST	--	--	6	us	10% to 90% target voltage. CL=120pF, R=10KW
CLKIN frequency	fCLK	--	40	50	MHz	VDD=3.0 ~ 3.6V
CLKIN cycle time	tCLK	20	25	--	ns	
CLKIN pulse duty	tCWH	40	50	60	%	TCLK
Time from HSD to Source output	tHSO	--	20	--	CLKIN	
Time from HSD to LD	tHLD	--	20	--	CLKIN	Note (2)
Time from HSD to STV	tHSTV	--	2	--	CLKIN	
Time from HSD to CKV	tHCKV	--	20	--	CLKIN	
Time from HSD to OEV	tHOEV	--	4	--	CLKIN	
LD pulse width	tWLD	--	10	--	CLKIN	Note (2)
CKV pulse width	tWCKV	--	66	--	CLKIN	
OEV pulse width	tWOEV	--	74	--	CLKIN	

Note: (1) VDD=3.0 ~ 3.6V, VDDA=6.5~13.5V, DGND=AGND=0V, Ta=-20~+85°C

(2) The contents of the data register are transferred to the latch circuit at the rising edge of LD. Then the gray scale voltage is output from the device at the falling edge of LD.

(3) Output loading condition :

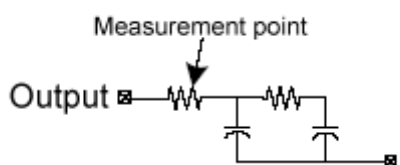

Input Clock and Data Timing Diagram

DE Mode (MODE='1')

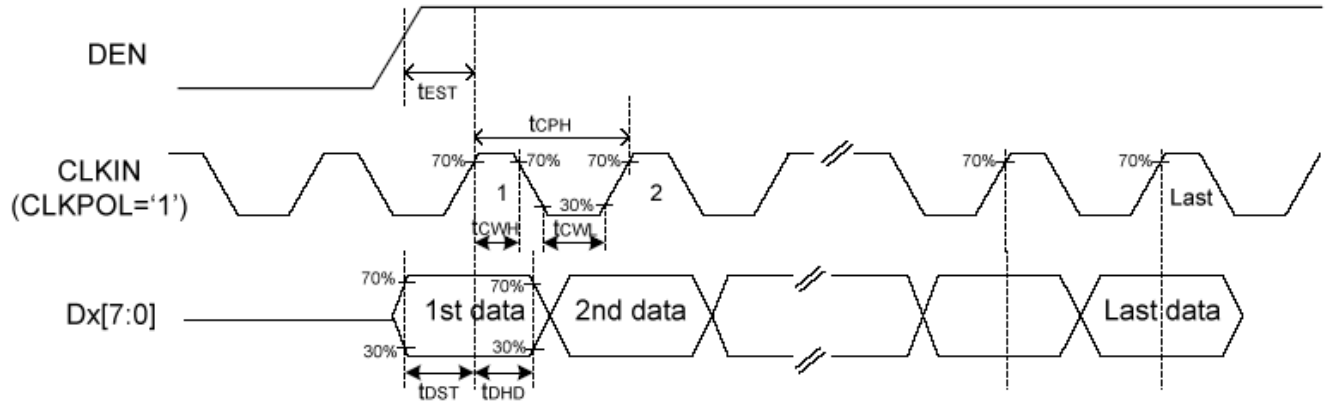

Source Output timing Diagram (Cascade)

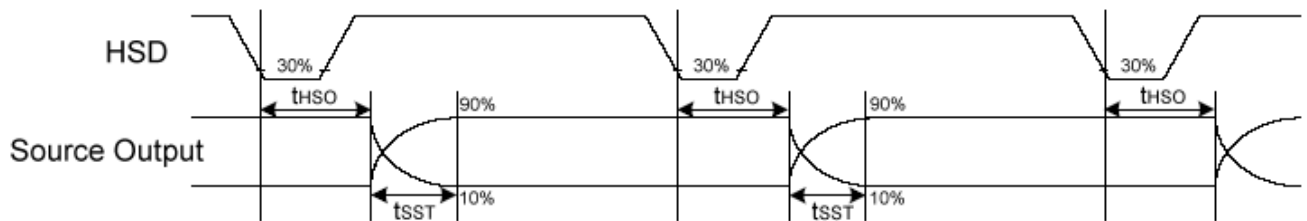

SYNC Mode (MODE='0')

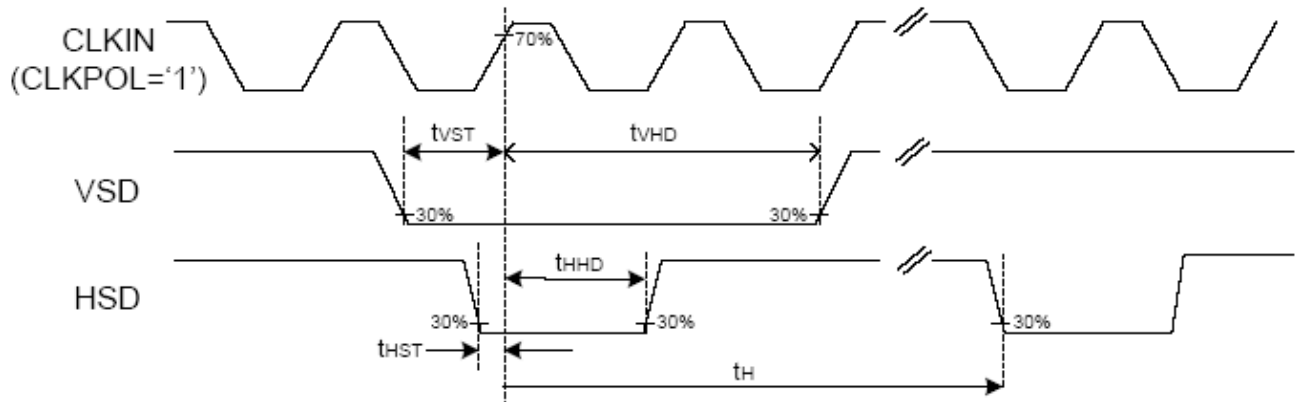

Timing

Horizontal Input Timing						
Parameter	Symbol	Value			Unit	
		Min.	Typ.	Max.		
Horizontal display area	tHD	--	800	--	CLKIN	
CLKIN frequency	fCLK	--	33.3	50	MHz	
1 Horizontal line period	tH	862	1056	1200	CLKIN	
HSD pulse width	tHPW	Min.	--	1	--	CLKIN
		Typ.	--	--	--	CLKIN
		Max.	--	40	--	CLKIN
HSD back porch	SYNC	tHBP	46	46	46	CLKIN
HSD front porch	SYNC	tHFP	16	210	354	CLKIN

Vertical Input Timing					
Parameter	Symbol	Value			Unit
		Min.	Typ.	Max.	
Vertical display area	tVD	--	480	--	HSD
VSD period time	tV	510	525	650	HSD
VSD pulse width	tVPW	1	--	20	HSD
VSD back porch	tVBP	23	23	23	HSD
VSD front porch	tVFP	7	22	147	HSD

Parameter	Symbol	Spec			Unit	Conditions
		Min.	Typ.	Max.		
SCL period	TCK	60	--	--	ns	
SCL high width	TCKH	30	--	--	ns	
SCL low width	TCKL	30	--	--	ns	
Data setup time	TSU1	12	--	--	ns	
Data hold time	THD1	12	--	--	ns	
CSX to SCL setup time	TCS	20	--	--	ns	
CSX to SDA hold time	TCE	20	--	--	ns	
CSX high pulse width	TCD	50	--	--	ns	

Data Input Format

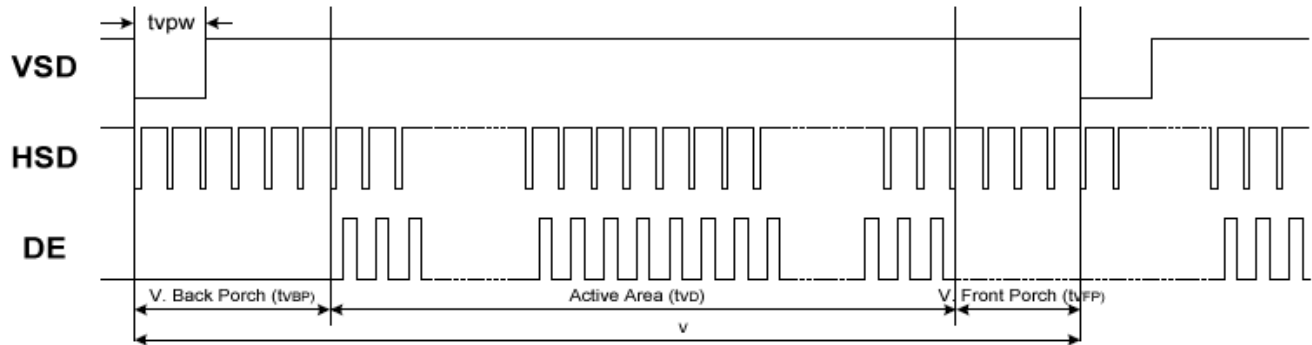
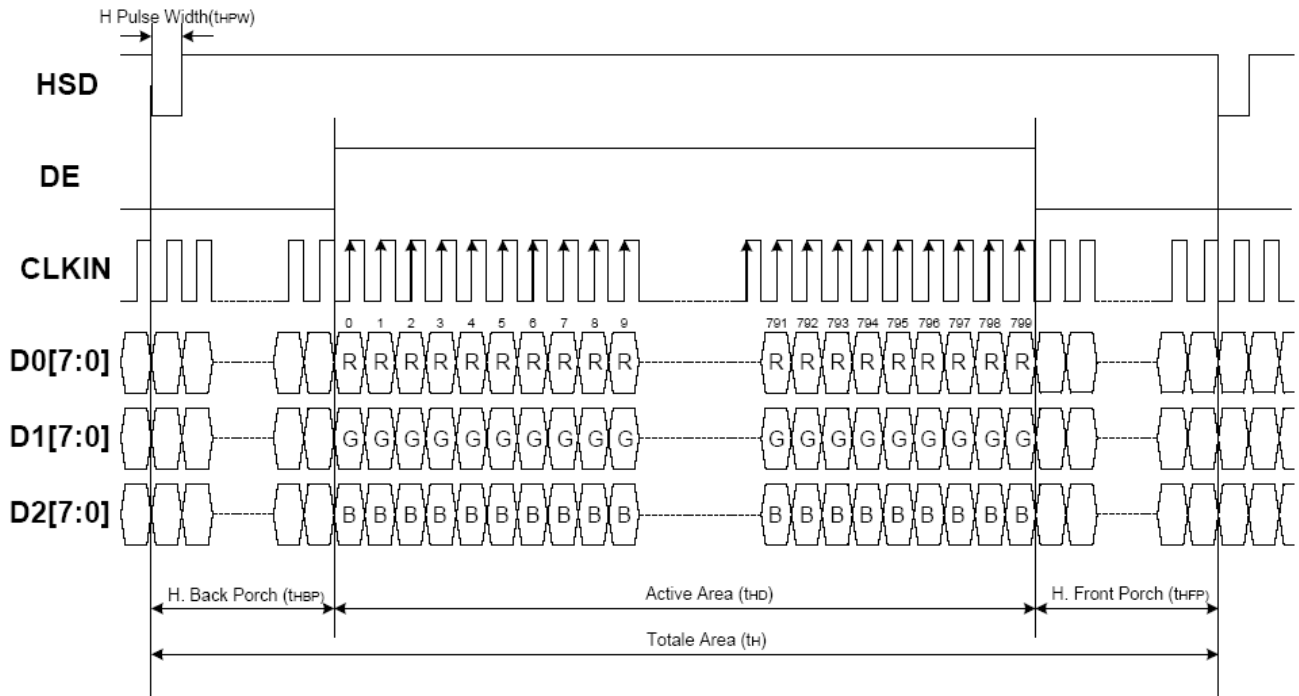

SPI Timing

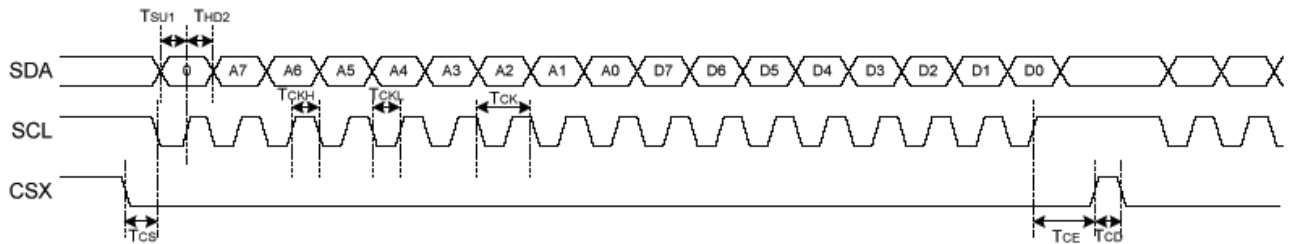

8. Optical Characteristics

Item	Symbol	Condition.	Min	Typ.	Max.	Unit	Remark	
Response time	Tr	$\theta=0^\circ$ 、 $\phi=0^\circ$	-	10	20	.ms	Note 3,5	
	Tf		-	10	20	.ms		
Contrast ratio	CR	At optimized viewing angle	500	700	-	-	Note 4,5	
Color Chromaticity	White	Wx	$\theta=0^\circ$ 、 $\phi=0$	0.26	0.31	0.36	Note 2,6,7	
		Wy		0.28	0.33	0.38		
Viewing angle	Hor.	θ_R	$CR \geq 10$	60	70	-	Deg.	Note 1
		θ_L		60	70	-		
	Ver.	ϕ_T		40	50	-		
		ϕ_B		60	70	-		
Brightness	-	-	250	300	-	cd/ m ²	Center of display	

Ta=25±2℃

Note 1: Definition of viewing angle range

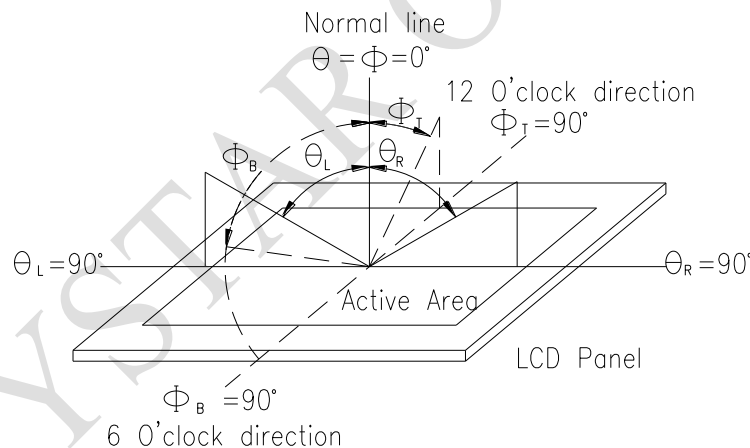

Fig. 8.1. Definition of viewing angle

Note 2: Test equipment setup:

After stabilizing and leaving the panel alone at a driven temperature for 10 minutes, the measurement should be executed. Measurement should be executed in a stable, windless, and dark room. Optical specifications are measured by Topcon BM-7or BM-5 luminance meter 1.0° field of view at a distance of 50cm and normal direction.

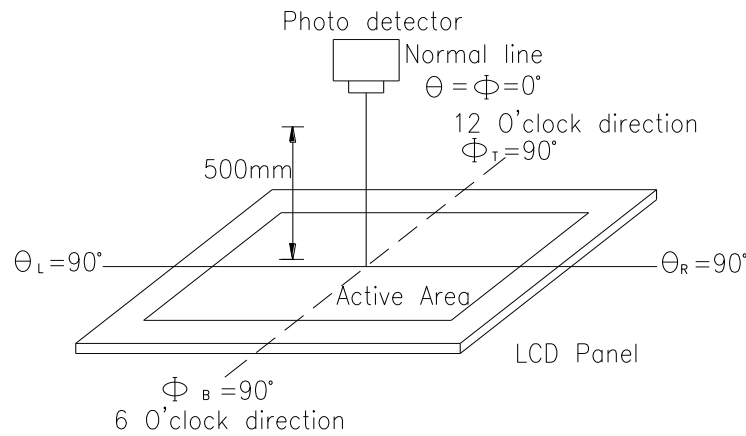
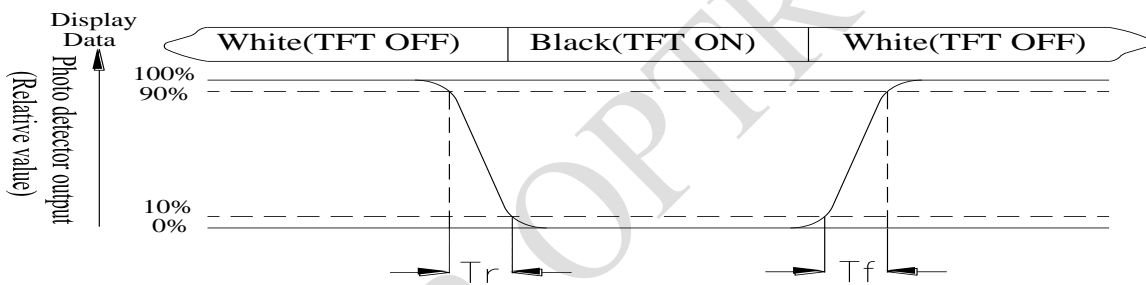

Fig. 8.2. Optical measurement system setup

Note 3: Definition of Response time:

The response time is defined as the LCD optical switching time interval between “White” state and “Black” state. Rise time, T_r , is the time between photo detector output intensity changed from 90% to 10%. And fall time, T_f , is the time between photo detector output intensity changed from 10% to 90%



Note 4: Definition of contrast ratio:

The contrast ratio is defined as the following expression.

$$\text{Contrast ratio (CR)} = \frac{\text{Luminance measured when LCD on the "White" state}}{\text{Luminance measured when LCD on the "Black" state}}$$

Note 5: White $V_i = V_{i50} \pm 1.5V$

Black $V_i = V_{i50} \pm 2.0V$

“±” means that the analog input signal swings in phase with VCOM signal.

“±” means that the analog input signal swings out of phase with VCOM signal.

The 100% transmission is defined as the transmission of LCD panel when all the input terminals of module are electrically opened.

Note 6: Definition of color chromaticity (CIE 1931)

Color coordinates measured at the center point of LCD

Note 7: Measured at the center area of the panel when all the input terminals of LCD panel are electrically opened.

9. Reliability

Content of Reliability Test (Wide temperature, -20°C~70°C)

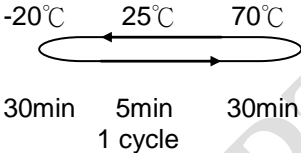
Environmental Test			
Test Item	Content of Test	Test Condition	Note
High Temperature storage	Endurance test applying the high storage temperature for a long time.	80°C 200hrs	2
Low Temperature storage	Endurance test applying the low storage temperature for a long time.	-30°C 200hrs	1,2
High Temperature Operation	Endurance test applying the electric stress (Voltage & Current) and the thermal stress to the element for a long time.	70°C 200hrs	—
Low Temperature Operation	Endurance test applying the electric stress under low temperature for a long time.	-20°C 200hrs	1
High Temperature/ Humidity Operation	The module should be allowed to stand at 60°C,90%RH max	60°C,90%RH 96hrs	1,2
Thermal shock resistance	The sample should be allowed stand the following 10 cycles of operation <div style="text-align: center;">  <p>-20°C 25°C 70°C</p> <p>30min 5min 30min</p> <p>1 cycle</p> </div>	-20°C/70°C 10 cycles	—
Vibration test	Endurance test applying the vibration during transportation and using.	Total fixed amplitude : 3 15mm Vibration Frequency : 10~55Hz One cycle 60 seconds to 3 directions of X,Y,Z for Each 15 minutes	3
Static electricity test	Endurance test applying the electric stress to the terminal.	VS=±600V(contact) ,±800v(air), RS=330Ω CS=150pF 10 times	—

Note1: No dew condensation to be observed.

Note2: The function test shall be conducted after 4 hours storage at the normal Temperature and humidity after remove from the test chamber.

Note3: The packing have to including into the vibration testing.

10.Touch Panel Information

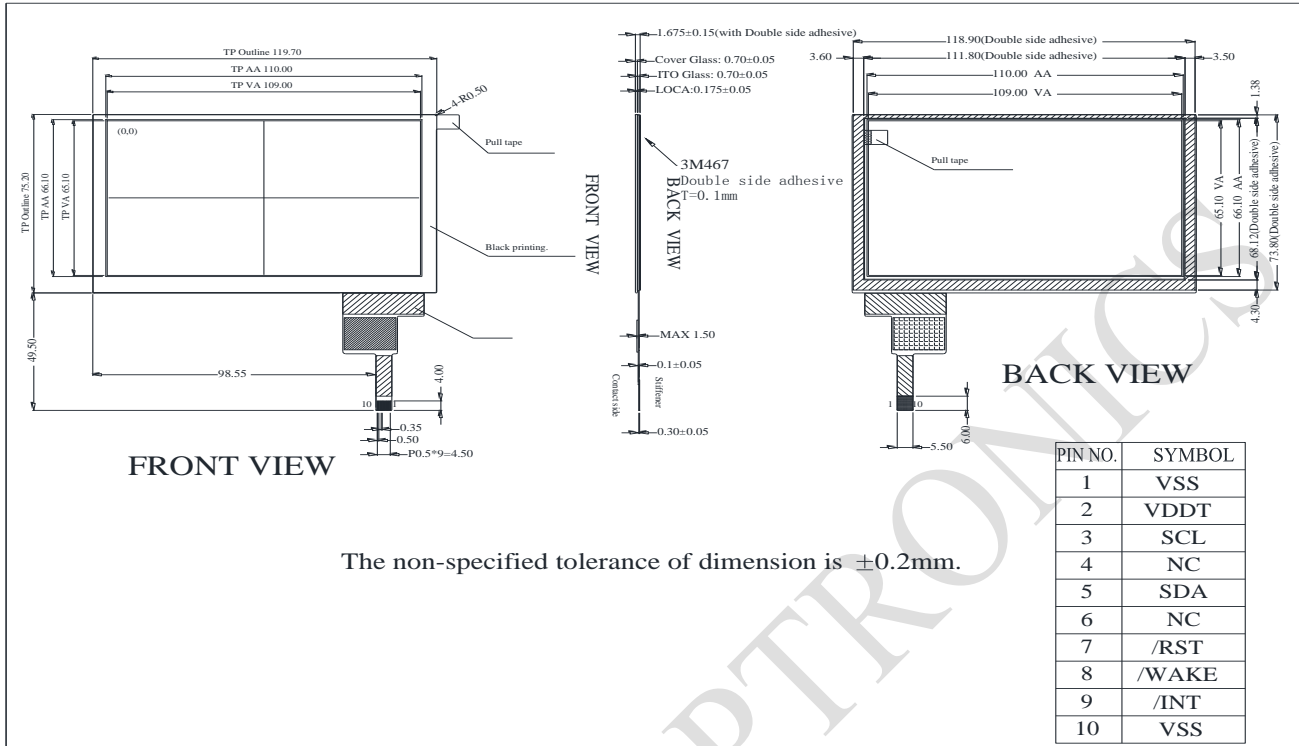

10.1. CTP I2C Timing:

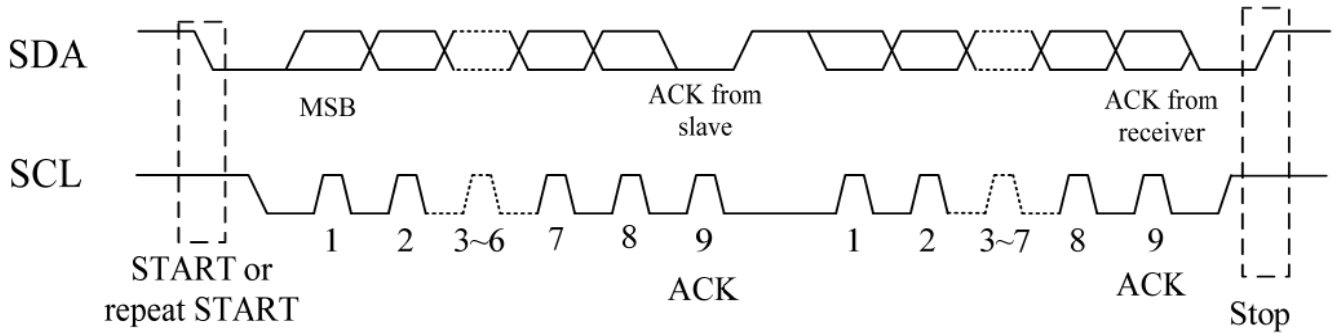

I2C Serial Data Transfer Format

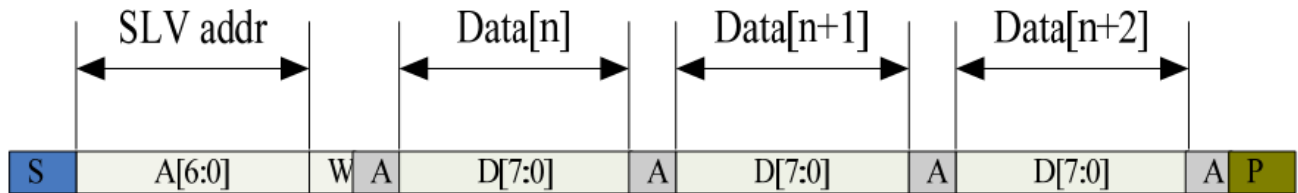

I2C master write, slave read

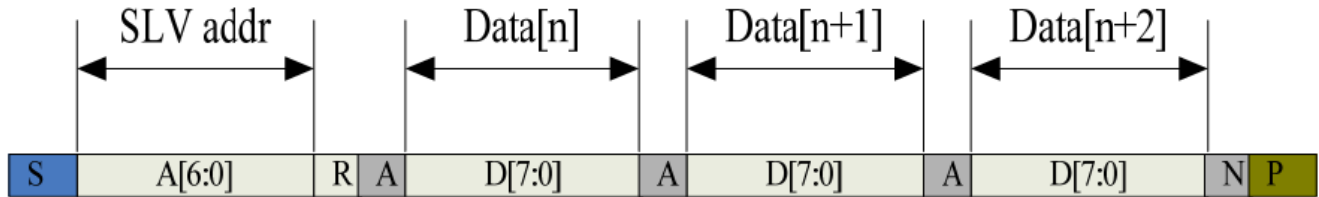

I2C master read, slave write

Mnemonics	Description
S	12C Start or 12C Restart
A[6:0]	Slave address A[6:4]:3'b011 A[3:0]:data bits are identical to those of 12CCON[7:4]register
W	1'b0:Write
R	1'b1:Read
A(N)	ACK(NACK)
P	STOP :the indication of the end of a packet(if this bit is missing, S will indicate the end of the current packet and beginning of the next packet)

Lists the meanings of the mnemonics used in the above figures

Parameter	Unit	Min	Max
SCL frequency	KHz	0	400
Bus free time between a STOP and START condition	us	4.7	\
Hold time (repeated) START condition	us	4.0	\
Data setup time	ns	250	\
Setup time for a repeated START condition	us	4.7	\
Setup time for STOP condition	us	4.0	\

Interface Timing Characteristics

AS FOR STANDARD CTPM, HOST NEED TO USE BOTH INTERRUPT CONTROL SIGNAL AND SERIAL DATA INTERFACE TO GET THE TOUCH DATA.

HERE IS THE TIMING TO GET TOUCH DATA.

10.2. WRITE BYTES TO I2C SLAVE

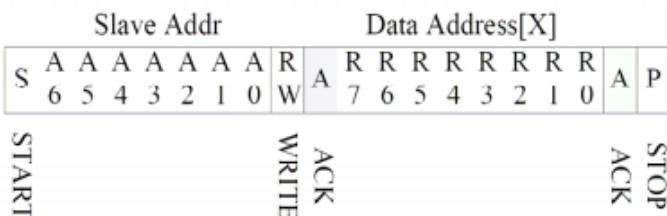
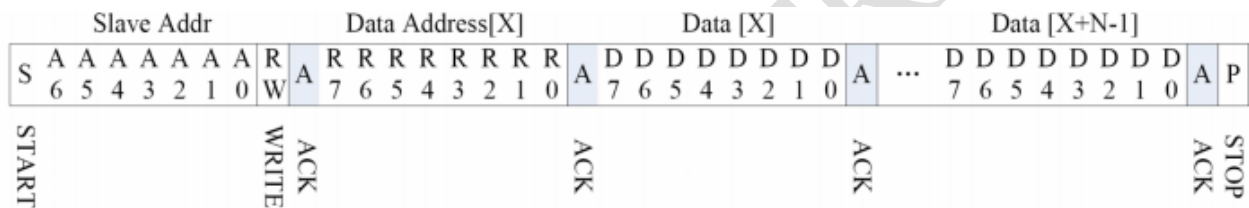

READ X BYTES FROM I2C SLAVE

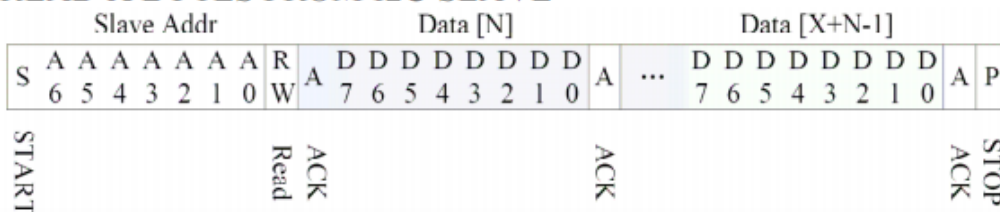

AS FOR STANDARD CTPM, HOST NEED TO USE BOTH INTERRUPT CONTROL SIGNAL AND SERIAL DATA INTERFACE TO GET THE TOUCH DATA, HERE IS THE TIMING TO GET TOUCH DATA.

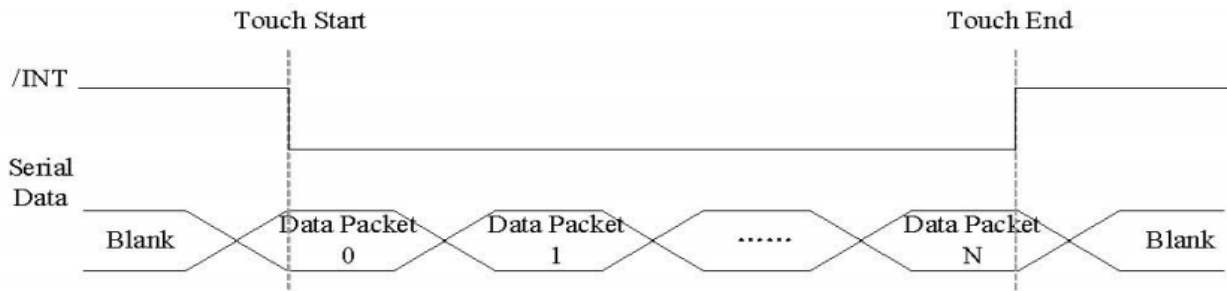

Address: 0x38

TOUCH DATA READ PROTOCOL

NAME	VALUE	DESCRIPTION
START CH	0X00	START COMMAND FOR CTPM TOUCH DATA PACKET,HOST MUST SEND CTPM A START CH COMMAND BEFORE READ TOUCH DATA
1st READ BYTE ~ LAST READ BYTE		TOUCH DATA PACKET SENT BY CTPM,EACH BYTE HAS 8-BIT DATA ,A TOUCH DATA PACKET CONSISTS OF N BYTE

A DATA PACKET STARTS WITH A HEADER AND ENDS WITH CRC CODE,AS FOR 5 POINTS DATA PACKET,THE LENGTH OF THE PACKET IS ALWAYS 26 BYTES IN SPITE OF ACTUAL TOUCH POINTS.

Address	Name	Bit7	Bit6	Bit5	Bit4	Bit3	Bit2	Bit1	Bit0	Host Access
00h	Devide__Mode		Device Model[2:0]							RW
01h	Gest__ID	Gesture ID[7:0]								R
02h	TD__Status					Number of touch points[3:0]			R	
03h	Touch1__XH	1 st Event Flag				1 st Touch X Position[11:8]			R	
04h	Touch1__XL	1 st Touch X Position[7:0]								R
05h	Touch1__YH	1 st Touch ID[3:0]					1 st Touch Y Position[11:8]			R
06h	Touch1__YL	1 st Touch Y Position[7:0]								R
09h	Touch2__XH	2 nd Event Flag				2 nd Touch X Position[11:8]			R	
0Ah	Touch2__XL	2 nd Touch X Position[7:0]								R

0Bh	Touch2__YH	2nd Touch ID[3:0]	2ndTouch Y Position[11:8]	R
0Ch	Touch2__YL	2nd Touch Y Position[7:0]		R

0Fh	Touch3__XH	3rdEvent Flag		3rdTouch X Position[11:8]	R
10h	Touch3__XL	3rd Touch X Position[7:0]			R
11h	Touch3__YH	3rdTouch ID[3:0]		3rdTouch Y Position[11:8]	R
12h	Touch3__YL	3rd Touch Y Position[7:0]			R
15h	Touch4__XH	4thEvent Flag		4thTouch X Position[11:8]	R
16h	Touch4__XL	4th Touch X Position[7:0]			R
17h	Touch4__YH	4thTouch ID[3:0]		4thTouch Y Position[11:8]	R
18h	Touch4__YL	4th Touch Y Position[7:0]			R
1Bh	Touch5__XH	5thEvent Flag		5thTouch X Position[11:8]	R
1Ch	Touch5__XL	5th Touch X Position[7:0]			R
1Dh	Touch5__YH	5thTouch ID[3:0]		5thTouch Y Position[11:8]	R
1Eh	Touch5__YL	5th Touch Y Position[7:0]			R

LCM Sample Estimate Feedback Sheet

Module Number : _____

1 、 Panel Specification :

1. Panel Type :	<input type="checkbox"/> Pass	<input type="checkbox"/> NG , _____
2. View Direction :	<input type="checkbox"/> Pass	<input type="checkbox"/> NG , _____
3. Numbers of Dots :	<input type="checkbox"/> Pass	<input type="checkbox"/> NG , _____
4. View Area :	<input type="checkbox"/> Pass	<input type="checkbox"/> NG , _____
5. Active Area :	<input type="checkbox"/> Pass	<input type="checkbox"/> NG , _____
6. Operating Temperature :	<input type="checkbox"/> Pass	<input type="checkbox"/> NG , _____
7. Storage Temperature :	<input type="checkbox"/> Pass	<input type="checkbox"/> NG , _____
8. Others :	_____	

2 、 Mechanical Specification :

1. PCB Size :	<input type="checkbox"/> Pass	<input type="checkbox"/> NG , _____
2. Frame Size :	<input type="checkbox"/> Pass	<input type="checkbox"/> NG , _____
3. Material of Frame :	<input type="checkbox"/> Pass	<input type="checkbox"/> NG , _____
4. Connector Position :	<input type="checkbox"/> Pass	<input type="checkbox"/> NG , _____
5. Fix Hole Position :	<input type="checkbox"/> Pass	<input type="checkbox"/> NG , _____
6. Backlight Position :	<input type="checkbox"/> Pass	<input type="checkbox"/> NG , _____
7. Thickness of PCB :	<input type="checkbox"/> Pass	<input type="checkbox"/> NG , _____
8. Height of Frame to PCB :	<input type="checkbox"/> Pass	<input type="checkbox"/> NG , _____
9. Height of Module :	<input type="checkbox"/> Pass	<input type="checkbox"/> NG , _____
10. Others :	<input type="checkbox"/> Pass	<input type="checkbox"/> NG , _____

3 、 Relative Hole Size :

1. Pitch of Connector :	<input type="checkbox"/> Pass	<input type="checkbox"/> NG , _____
2. Hole size of Connector :	<input type="checkbox"/> Pass	<input type="checkbox"/> NG , _____
3. Mounting Hole size :	<input type="checkbox"/> Pass	<input type="checkbox"/> NG , _____
4. Mounting Hole Type :	<input type="checkbox"/> Pass	<input type="checkbox"/> NG , _____
5. Others :	<input type="checkbox"/> Pass	<input type="checkbox"/> NG , _____

4 、 Backlight Specification :

1. B/L Type :	<input type="checkbox"/> Pass	<input type="checkbox"/> NG , _____
2. B/L Color :	<input type="checkbox"/> Pass	<input type="checkbox"/> NG , _____
3. B/L Driving Voltage (Reference for LED Type) :	<input type="checkbox"/> Pass	<input type="checkbox"/> NG , _____
4. B/L Driving Current :	<input type="checkbox"/> Pass	<input type="checkbox"/> NG , _____
5. Brightness of B/L :	<input type="checkbox"/> Pass	<input type="checkbox"/> NG , _____
6. B/L Solder Method :	<input type="checkbox"/> Pass	<input type="checkbox"/> NG , _____
7. Others :	<input type="checkbox"/> Pass	<input type="checkbox"/> NG , _____

>> **Go to page 2** <<

Module Number : _____		
5 · <u>Electronic Characteristics of Module</u> :		
1.Input Voltage :	<input type="checkbox"/> Pass	<input type="checkbox"/> NG , _____
2.Supply Current :	<input type="checkbox"/> Pass	<input type="checkbox"/> NG , _____
3.Driving Voltage for LCD :	<input type="checkbox"/> Pass	<input type="checkbox"/> NG , _____
4.Contrast for LCD :	<input type="checkbox"/> Pass	<input type="checkbox"/> NG , _____
5.B/L Driving Method :	<input type="checkbox"/> Pass	<input type="checkbox"/> NG , _____
6.Negative Voltage Output :	<input type="checkbox"/> Pass	<input type="checkbox"/> NG , _____
7.Interface Function :	<input type="checkbox"/> Pass	<input type="checkbox"/> NG , _____
8.LCD Uniformity :	<input type="checkbox"/> Pass	<input type="checkbox"/> NG , _____
9.ESD test :	<input type="checkbox"/> Pass	<input type="checkbox"/> NG , _____
10.Others :	<input type="checkbox"/> Pass	<input type="checkbox"/> NG , _____
6 · <u>Summary</u> :		
<p style="text-align: right;">Sales signature : _____</p> <p style="text-align: right;">Customer Signature : _____ <u>Date</u> : / / _____</p>		