

# RFE43BE-ALW-DNN

---

---

## SPECIFICATION

CUSTOMER:

APPROVED BY	
PCB VERSION	
DATE	

FOR CUSTOMER USE ONLY

SALES BY	APPROVED BY	CHECKED BY	PREPARED BY

Release DATE:

---

---

## Revision History

VERSION	DATE	REVISED PAGE NO.	Note
0	2018/05/03		First issue

# Contents

1. Module Classification Information
2. Summary
3. General Specification
4. Interface
5. Contour Drawing
6. Block Diagram
7. Absolute Maximum Ratings
8. Electrical Characteristics
9. Interface Timing
10. Optical Characteristics
11. Reliability
12. Other





---

## 2.Summary

TFT 4.3” is a TN transmissive type color active matrix TFT liquid crystal display that use amorphous silicon TFT as switching devices. This module is a composed of a TFT\_LCD module, It is usually designed for industrial application and this module follows RoHs,

---

## 3.General Specifications

- Size: 4.3 inch
- Dot Matrix: 480 RGB(H) x 272(V) dots
- Module dimension: 105.5 x 67.2x 2.9 (Typ.) mm
- Active area: 95.04(H) x 53.85(V) mm
- Dot pitch: 0.198(H) x 0.198(V) mm
- LCD type: TFT, Normally White, Transmissive
- View Direction: 6 o'clock
- Gray Scale Inversion Direction: 12 o'clock
- Aspect Ratio: 16:9
- Backlight Type: Normally White
- With /Without TP: Without TP
- Surface: Anti-Glare

\*Color tone slight changed by temperature and driving voltage.

## 4.Interface

### 4.1. LCM PIN Definition

No.	Symbol	Description
1	VBL-	Backlight LED Cathode
2	VBL+	Backlight LED Anode.
3	GND	System Ground
4	VCC	Power supply for logic operation
5~12	R0~R7	Data bus
13~20	G0~G7	Data bus
21~28	B0~B7	Data bus
29	GND	System Ground
30	CLK	Pixel clock signal
31	DISP	Display on/off control
32	HSYNC	Horizontal Sync signal
33	VSYNC	Vrtical Sync signal
34	DEN	Data Enable
35	NC	No connect
36	GND	System Ground
37	NC	No connect
38	NC	No connect
39	NC	No connect
40	NC	No connect



# 5. Contour Drawing

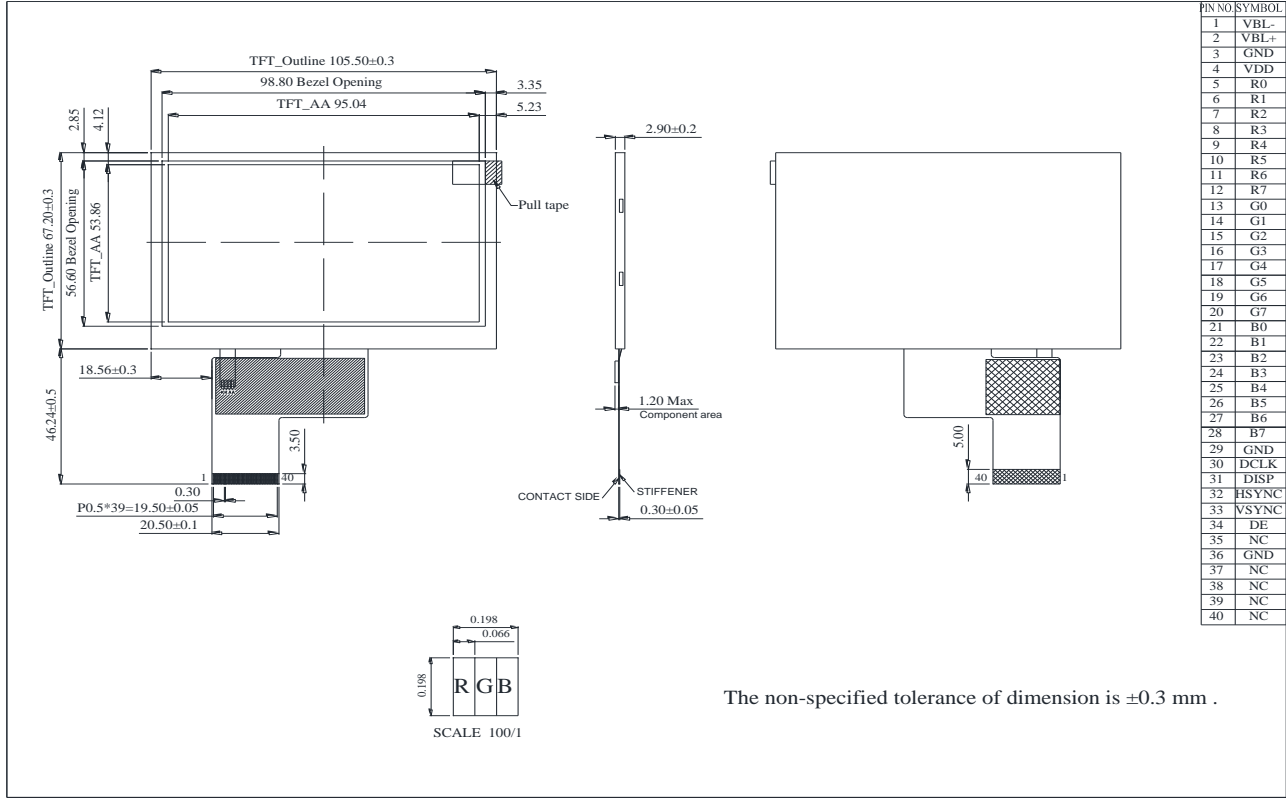

## 6. Block Diagram

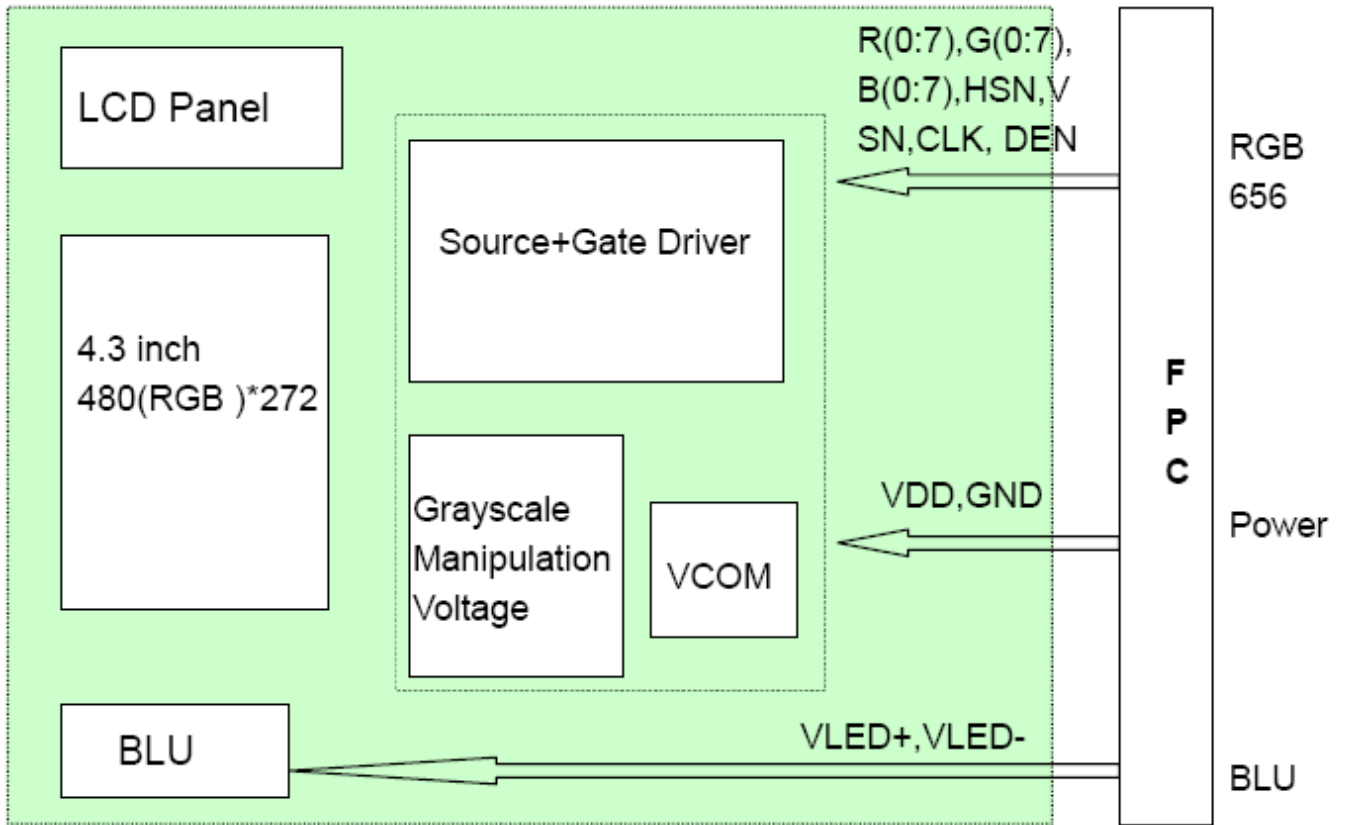

---

---

## 7. Absolute Maximum Ratings

Item	Symbol	Min	Typ	Max	Unit
Operating Temperature	TOP	-20	—	+70	°C
Storage Temperature	TST	-30	—	+80	°C

Note: Device is subject to be damaged permanently if stresses beyond those absolute maximum ratings listed above

1. Temp.  $\leq 60^{\circ}\text{C}$ , 90% RH MAX. Temp.  $> 60^{\circ}\text{C}$ , Absolute humidity shall be less than 90% RH at  $60^{\circ}\text{C}$

## 8. Electrical Characteristics

### 8.1. Driving TFT LCD Panel

Ta = 25 °C

Item	Symbol	MIN	TYP	MAX	Unit	Remark
Supply Voltage	VDD	3.0	3.3	3.6	V	
Input Signal Voltage	Low Level	VIL	GND	-	0.3x VDD	V
	High Level	VIH	0.7x VDD	-	VDD	V
Output Signal Voltage	Low Level	VIL	-	-	0.2x VDD	V
	High Level	VIH	0.8x VDD	-	VDD	V
(Panel + LSI) Power Consumption	Black Mode (60Hz)	-	74		nW	
	Standby	-	50	-	uW	

### 8.2. Driving Backlight

Item	Symbol	MIN	TYP	MAX	Unit	Remark
Forward Current	IF	-	40	50	mA	
Forward Voltage	VF	-	16	16.5	V	
Backlight Power consumption	WBL	-	0.64	0.825	W	
LED Life Time		-	25,000	-	Hr	Note 2,3,4

Note 1: Each LED : IF =20 mA, VF =3.2V.

Note 2: Optical performance should be evaluated at Ta=25°C only.

Note 3: If LED is driven by high current, high ambient temperature & humidity condition. The life time of LED will be reduced. Operating life means brightness goes down to 50% initial brightness. Typical operating life time is estimated data.

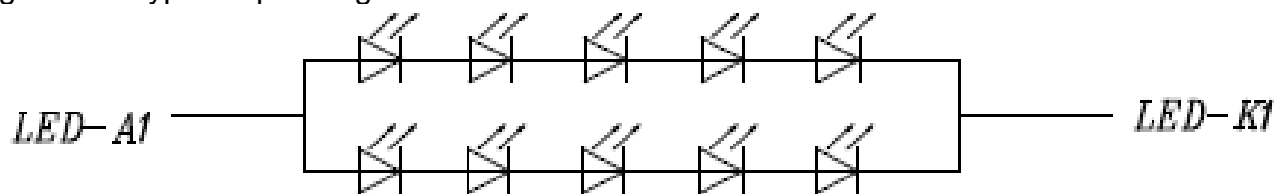

Figure: LED connection of backlight

## 9.Interface Timing

### 9.1. Input Setup Timing Setting

#### Input Setup Timing Parameter Setting

Item	Symbol	Min.	Typ.	Max.	Unit	Conditions
System operation timing						
VDD power source slew time	TPOR	-	-	20	ms	From 0V to 99% VDD
GRB pulse width	tRSTW	10	50	-	us	R=10Kohm, C=1uF
Input/ Output timing						
CLK pulse duty	Tcw	40	50	60	%	
Hsync width	Thw	1	-	-	DCLK	
Hsync period	Th	55	60	65	us	
Vsync setup time	Tvst	12	-	-	ns	
Vsync hold time	Tvhd	12	-	-	ns	
Hsync setup time	Thst	12	-	-	ns	
Hsync hold time	Thhd	12	-	-	ns	
Data setup time	Tdsu	12	-	-	ns	
Data hold time	Tdhhd	12	-	-	ns	
DE setup time	Tdest	10	-	-	ns	
DE hold time	Tdehd	10	-	-	ns	
SD output stable time	Tst	-	-	12	us	Output settled within +20mV Loading = 6.8k+28.2pF.
GD output rise and fall time	Tgst	-	-	6	us	Output settled (5%~95%), Loading = 4.7k+29.8pF
3-wire serial communication						
Delay between CSB and Vsync	Tcv	1			us	
CS input setup time	Ts0	50			ns	
Serial data input setup time	Ts1	50			ns	
CS input hold time	Th0	50			ns	
Serial data input hold time	Th1	50			ns	
SCL pulse high width	Twh1	50			ns	
SCL pulse low width	Twl1	50			ns	
CS pulse high width	Tw2	400			ns	

## Input Setup Timing Diagram

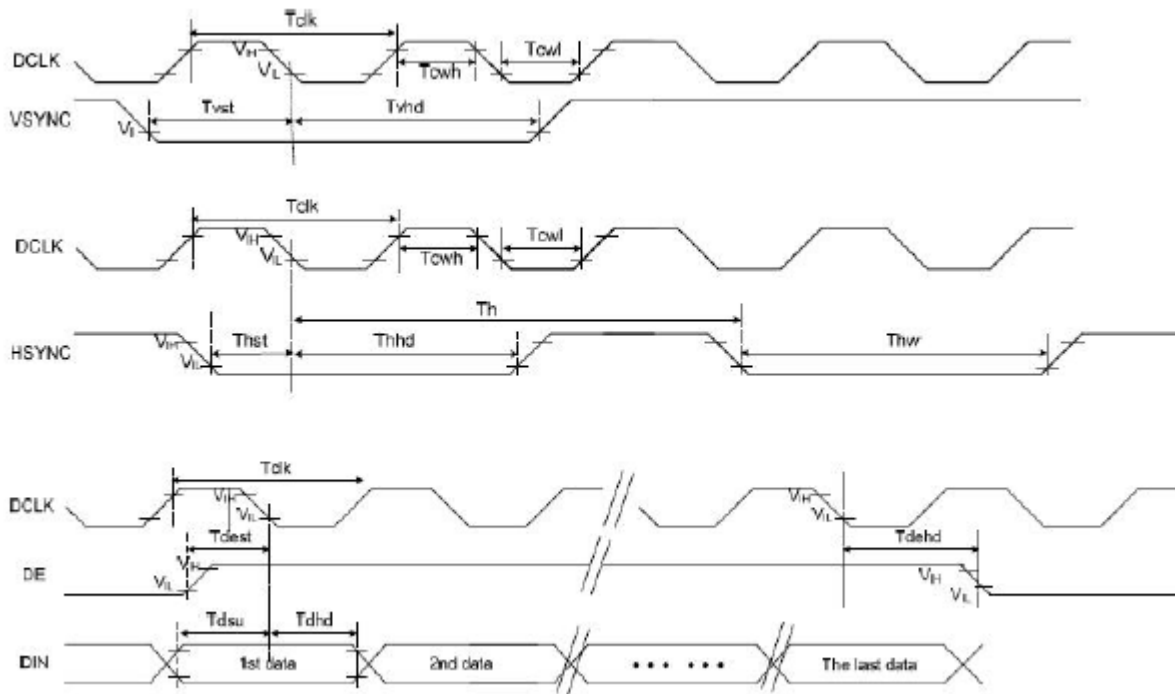

## 9.2. Data Input Format

### Data Input Timing Parameter Setting

Item	Symbol	Min.	Typ.	Max.	Unit	Remark	
DCLK Frequency	Fclk	8	9	12	MHz		
DCLK Period	Tclk	83	111	125	ns		
HSYNC	Period Time	$T_h$	485	531	598	DCLK	
	Display Period	$T_{hdisp}$		480		DCLK	
	Back Porch	$T_{hbp}$	3	43	43	DCLK	By H_Blanking setting
	Front Porch	$T_{hfp}$	2	8	75	DCLK	
	Pulse Width	$T_{hw}$	2	4	75	DCLK	
VSYNC	Period Time	$T_v$	276	292	321	H	
	Display Period	$T_{vdisp}$		272		H	
	Back Porch	$T_{vbp}$	2	12	12	H	By V_Blanking setting
	Front Porch	$T_{vfp}$	2	8	37	H	
	Pulse Width	$T_{vw}$	2	4	37	H	

Note: It is necessary to keep  $T_{vbp} = 12$  and  $T_{hbp} = 43$  in sync mode. DE mode is unnecessary to keep it.

**Data Input Timing Diagram**  
**Data Input Timing Diagram under SYNC Mode**

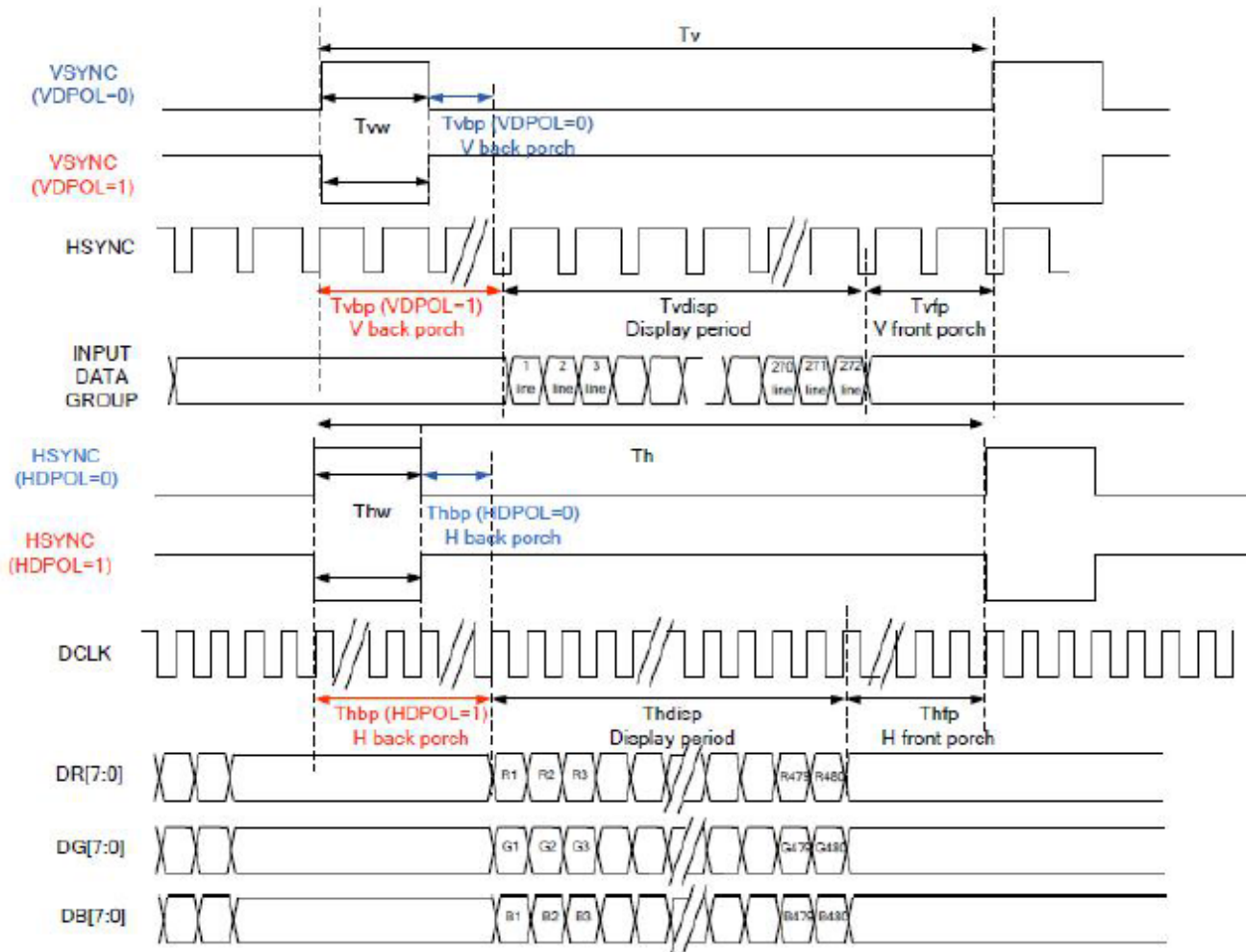

Data Input Timing Diagram under DE Mode

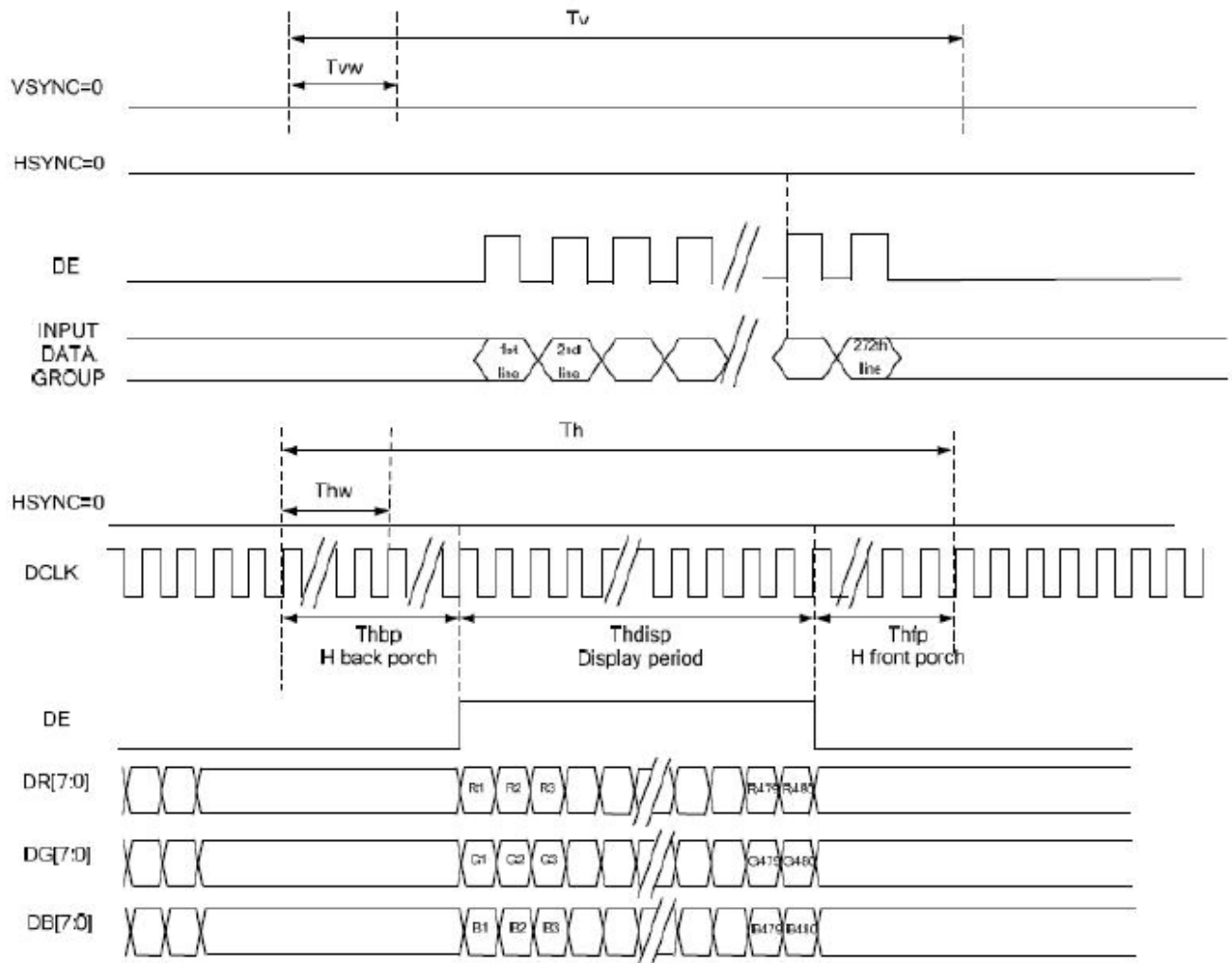



9.3. Power ON/OFF Sequence  
Power ON Sequence

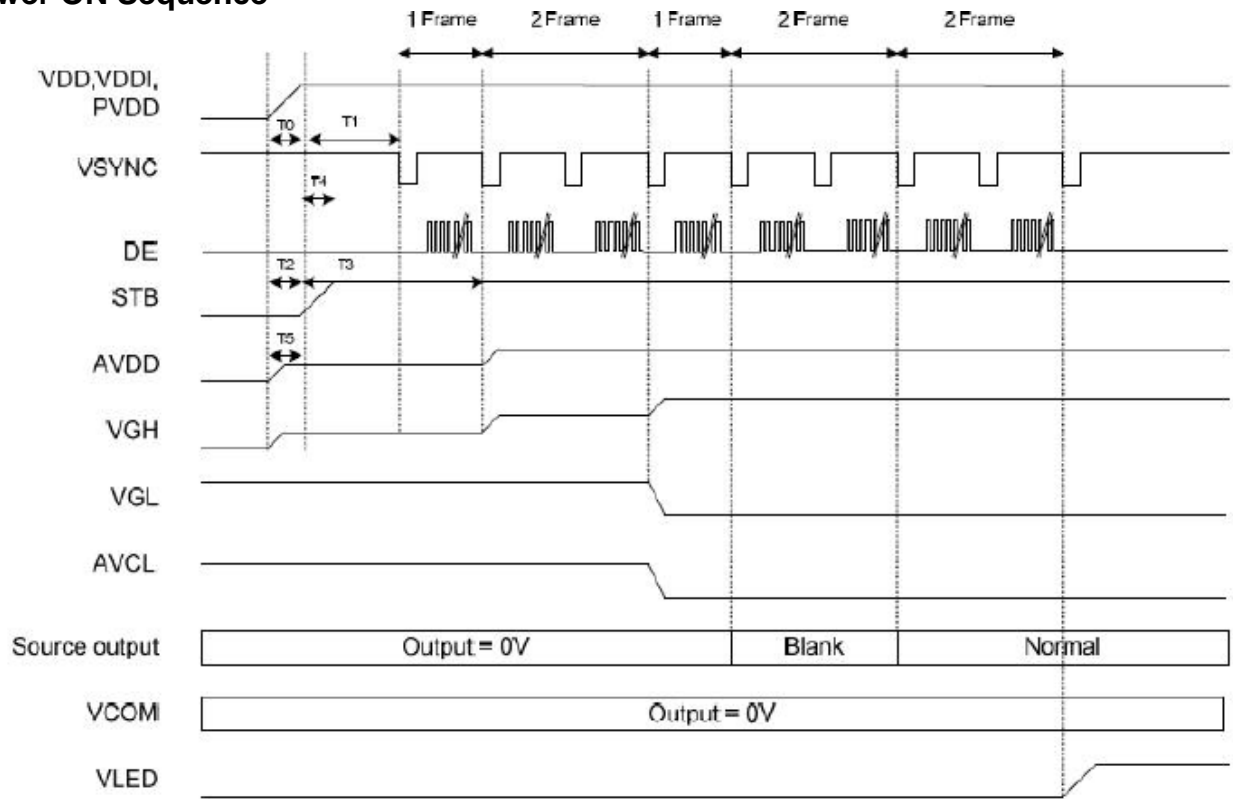

	Description	Min. Time
T0	Determined by the external power	
T1	Time from stable VDD, VDDI, PVDD set-up to the first VSYNC	T1=0
T2	Time from AVDD=0V to AVDD=3.3V	T2=T0
T3	Time from AVDD=3.3V to AVDD=6.0V	T3=T1+ (1*Frame)
T4	Time from stable VDD, VDDI, PVDD set-up to DISP asserted	T4=0
T5	Time from VGH=0V to VGH=3.3V	T5=T0

**Power OFF Sequence**

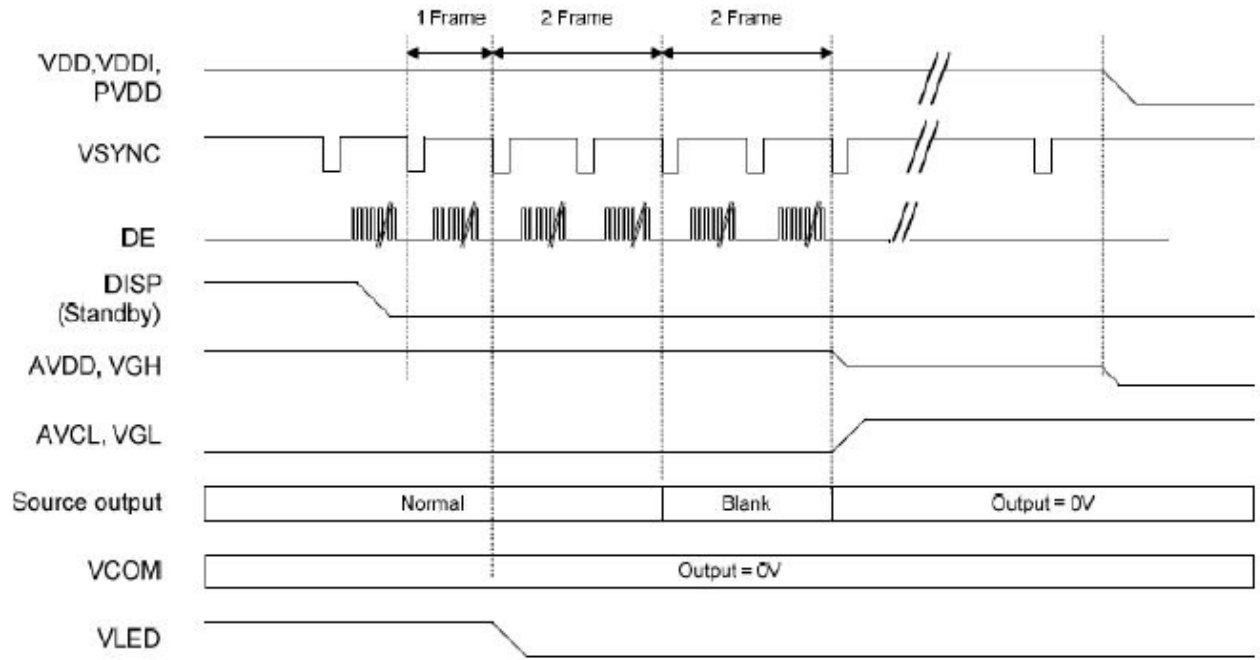

## 10. Optical Characteristics

Item	Symbol	Condition.	Min	Typ.	Max.	Unit	Remark	
Response time	Tr	$\theta=0^\circ$ 、 $\phi=0^\circ$	-	25	30	.ms	Note 3,5	
	Tf		-	25	30	.ms		
Contrast ratio	CR	At optimized viewing angle	400	500	-	-	Note 4,5	
Color Chromaticity	White	$\theta=0^\circ$ 、 $\phi=0^\circ$	Wx	0.26	0.31	0.36		Note 2,6,7
			Wy	0.28	0.33	0.38		
Viewing angle (Gray Scale Inversion Direction)	Hor.	CR $\geq$ 10	$\Theta_R$	60	70	-	Deg.	Note 1
			$\Theta_L$	60	70	-		
	Ver.		$\Phi_T$	60	70	-		
			$\Phi_B$	40	50	-		
Brightness	-	-	400	500	-	cd/ m <sup>2</sup>	Center of display	

Ta=25±2°C, IL=40mA

Note 1: Definition of viewing angle

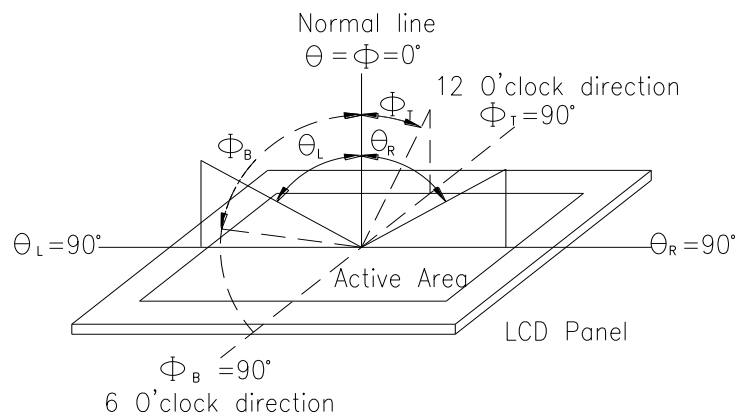

Fig.10.1. Definition of viewing angle

Note 2: Test equipment setup:

After stabilizing and leaving the panel alone at a driven temperature for 10 minutes, the measurement should be executed. Measurement should be executed in a stable, windless, and dark room. Optical specifications are measured by Topcon BM-7 or BM-5 luminance meter 1.0° field of view at a distance of 50cm and normal direction.

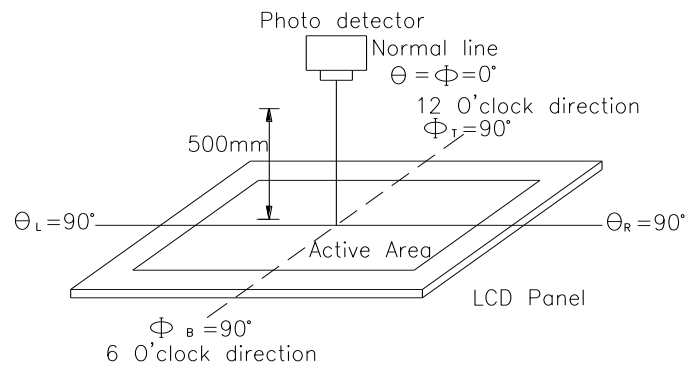
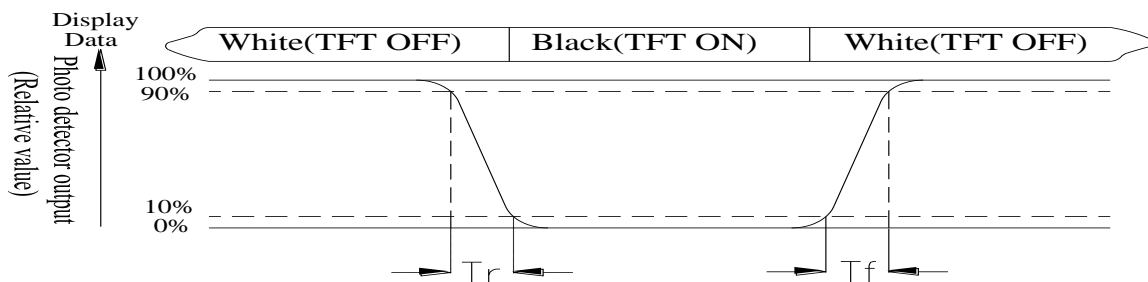

Fig. 10.2. Optical measurement system setup

**Note 3: Definition of Response time:**

The response time is defined as the LCD optical switching time interval between “White” state and “Black” state. Rise time,  $T_r$ , is the time between photo detector output intensity changed from 90% to 10%. And fall time,  $T_f$ , is the time between photo detector output intensity changed from 10% to 90%

**Note 4: Definition of contrast ratio:**

The contrast ratio is defined as the following expression.

$$\text{Contrast ratio (CR)} = \frac{\text{Luminance measured when LCD on the "White" state}}{\text{Luminance measured when LCD on the "Black" state}}$$

Note 5: White  $V_i = V_{i50} \pm 1.5V$

Black  $V_i = V_{i50} \pm 2.0V$

“±” means that the analog input signal swings in phase with VCOM signal.

“±” means that the analog input signal swings out of phase with VCOM signal.

The 100% transmission is defined as the transmission of LCD panel when all the input terminals of module are electrically opened.

Note 6: Definition of color chromaticity (CIE 1931)

Color coordinates measured at the center point of LCD

Note 7: Measured at the center area of the panel when all the input terminals of LCD panel are electrically opened.

## 11. Reliability

Content of Reliability Test (Wide temperature, -20°C~70°C)

Environmental Test			
Test Item	Content of Test	Test Condition	Note
High Temperature storage	Endurance test applying the high storage temperature for a long time.	80°C 200hrs	2
Low Temperature storage	Endurance test applying the low storage temperature for a long time.	-30°C 200hrs	1,2
High Temperature Operation	Endurance test applying the electric stress (Voltage & Current) and the thermal stress to the element for a long time.	70°C 200hrs	—
Low Temperature Operation	Endurance test applying the electric stress under low temperature for a long time.	-20°C 200hrs	1
High Temperature/ Humidity Operation	The module should be allowed to stand at 60°C, 90%RH max	60°C, 90%RH 96hrs	1,2
Thermal shock resistance (Non-operation)	The sample should be allowed stand the following 10 cycles of Non-operation <div style="text-align: center;"> <p style="margin: 0;">-30°C    25°C    80°C</p> <p style="margin: 0; text-align: center;">30min    5min    30min</p> <p style="margin: 0; text-align: center;">1 cycle</p> </div>	-30°C/80°C 10 cycles	—
Vibration test	Endurance test applying the vibration during transportation and using.	Total fixed amplitude : 1.5mm Vibration Frequency : 10~55Hz One cycle 60 seconds to 3 directions of X,Y,Z for Each 15 minutes	3
Static electricity test	Endurance test applying the electric stress to the terminal.	VS=±600V(contact) ,±800v(air), RS=330Ω CS=150pF 10 times	—

Note1: No dew condensation to be observed.

Note2: The function test shall be conducted after 4 hours storage at the normal Temperature and humidity after remove from the test chamber.

Note3: The packing have to including into the vibration testing.

<b><u>LCM Sample Estimate Feedback Sheet</u></b>		
<b>Module Number :</b> _____		
<b>1 、 <u>Panel Specification</u> :</b>		
1. Panel Type :	<input type="checkbox"/> Pass	<input type="checkbox"/> NG , _____
2. View Direction :	<input type="checkbox"/> Pass	<input type="checkbox"/> NG , _____
3. Numbers of Dots :	<input type="checkbox"/> Pass	<input type="checkbox"/> NG , _____
4. View Area :	<input type="checkbox"/> Pass	<input type="checkbox"/> NG , _____
5. Active Area :	<input type="checkbox"/> Pass	<input type="checkbox"/> NG , _____
6. Operating Temperature :	<input type="checkbox"/> Pass	<input type="checkbox"/> NG , _____
7. Storage Temperature :	<input type="checkbox"/> Pass	<input type="checkbox"/> NG , _____
8. Others : _____		
<b>2 、 <u>Mechanical Specification</u> :</b>		
1. PCB Size :	<input type="checkbox"/> Pass	<input type="checkbox"/> NG , _____
2. Frame Size :	<input type="checkbox"/> Pass	<input type="checkbox"/> NG , _____
3. Material of Frame :	<input type="checkbox"/> Pass	<input type="checkbox"/> NG , _____
4. Connector Position :	<input type="checkbox"/> Pass	<input type="checkbox"/> NG , _____
5. Fix Hole Position :	<input type="checkbox"/> Pass	<input type="checkbox"/> NG , _____
6. Backlight Position :	<input type="checkbox"/> Pass	<input type="checkbox"/> NG , _____
7. Thickness of PCB :	<input type="checkbox"/> Pass	<input type="checkbox"/> NG , _____
8. Height of Frame to PCB :	<input type="checkbox"/> Pass	<input type="checkbox"/> NG , _____
9. Height of Module :	<input type="checkbox"/> Pass	<input type="checkbox"/> NG , _____
10. Others :	<input type="checkbox"/> Pass	<input type="checkbox"/> NG , _____
<b>3 、 <u>Relative Hole Size</u> :</b>		
1. Pitch of Connector :	<input type="checkbox"/> Pass	<input type="checkbox"/> NG , _____
2. Hole size of Connector :	<input type="checkbox"/> Pass	<input type="checkbox"/> NG , _____
3. Mounting Hole size :	<input type="checkbox"/> Pass	<input type="checkbox"/> NG , _____
4. Mounting Hole Type :	<input type="checkbox"/> Pass	<input type="checkbox"/> NG , _____
5. Others :	<input type="checkbox"/> Pass	<input type="checkbox"/> NG , _____
<b>4 、 <u>Backlight Specification</u> :</b>		
1. B/L Type :	<input type="checkbox"/> Pass	<input type="checkbox"/> NG , _____
2. B/L Color :	<input type="checkbox"/> Pass	<input type="checkbox"/> NG , _____
3. B/L Driving Voltage (Reference for LED Type) : <input type="checkbox"/> Pass <input type="checkbox"/> NG , _____		
4. B/L Driving Current :	<input type="checkbox"/> Pass	<input type="checkbox"/> NG , _____
5. Brightness of B/L :	<input type="checkbox"/> Pass	<input type="checkbox"/> NG , _____
6. B/L Solder Method :	<input type="checkbox"/> Pass	<input type="checkbox"/> NG , _____
7. Others :	<input type="checkbox"/> Pass	<input type="checkbox"/> NG , _____

>> Go to page 2 <<

Module Number : \_\_\_\_\_

**5 · Electronic Characteristics of Module :**

1.Input Voltage :	<input type="checkbox"/> Pass	<input type="checkbox"/> NG , _____
2.Supply Current :	<input type="checkbox"/> Pass	<input type="checkbox"/> NG , _____
3.Driving Voltage for LCD :	<input type="checkbox"/> Pass	<input type="checkbox"/> NG , _____
4.Contrast for LCD :	<input type="checkbox"/> Pass	<input type="checkbox"/> NG , _____
5.B/L Driving Method :	<input type="checkbox"/> Pass	<input type="checkbox"/> NG , _____
6.Negative Voltage Output :	<input type="checkbox"/> Pass	<input type="checkbox"/> NG , _____
7.Interface Function :	<input type="checkbox"/> Pass	<input type="checkbox"/> NG , _____
8.LCD Uniformity :	<input type="checkbox"/> Pass	<input type="checkbox"/> NG , _____
9.ESD test :	<input type="checkbox"/> Pass	<input type="checkbox"/> NG , _____
10.Others :	<input type="checkbox"/> Pass	<input type="checkbox"/> NG , _____

**6 · Summary :**

Sales signature : \_\_\_\_\_

Customer Signature : \_\_\_\_\_

Date : / /