

PRODUCT SPECIFICATIONS

Product Name: LCD Module

Model PartNumber: HT320057B

Revision: R00

Date: 2010-1-4

Prepared By:	Reviewed By:	Approved By:
SZJ	YZL	ALJ

Customer: _____

Custoer Approved Result: OK NG

Custoer Confirmed Message: _____

Approved By: _____ Date: _____



Table of Contents

.....	1
Record of Revision.....	3
1. General Specifications	4
2. Input/Output Terminals	5
3. Absolute Maximum Ratings	6
4. Electrical Characteristics.....	7
4.1 Driving TFT LCD Panel.....	7
4.2 Driving Backlight.....	7
4.3 Block Diagram	8
5. Data input timing	9
5.1 SYNC mode.....	9
5.2 DE Mode.....	9
5.3 AC input characteristics	10
5.4 Timing Diagram	11
5.5 Power ON/OFF Sequence.....	12
6. Optical Characteristics	13
7. Environmental / Reliability Test	16
8. Mechanical Drawing	17
9. Packing Drawing	18
10. Precaution for Use of LCD Modules.....	19



1. General Specifications

Feature		Spec
Display Spec.	Size	5.7 inch
	Resolution	320(RGB) x 240
	Interface	RGB 18 bits
	Color Depth	262K
	Technology Type	a-Si
	Pixel Pitch (mm)	0.360x0.360
	Pixel Configuration	R.G.B. Vertical Stripe
	Display Mode	HT with Normally White
	Surface Treatment(Up Polarizer)	Anti-Glare(3H)
	Viewing Direction	6 o'clock
	Gray Scale Inversion Direction	12 o'clock
	LCM (W x H x D) (mm)	144.00x104.60x12.30
Mechanical Characteristics	Active Area(mm)	115.20x86.40
	With /Without TSP	Without TSP
	Weight (g)	160.00
	LED Numbers	15 LEDs

Note 1: Viewing direction for best image quality is different from TFT definition, there is a 180 degree shift.

Note 2: Requirements on Environmental Protection: Q/S0002

Note 3: LCM weight tolerance: $\pm 5\%$



2. Input/Output Terminals

2.1 CN1 pin assignment (Signal interface)

Connector type: 089H33-000100-G2-R (STARCONN)

No	Symbol	I/O	Description	Comment
1	GND	P	Ground	
2	DOTCLK	I	Dot clock. Latch data at falling edge of DOTCLK.	
3	Hsync	I	Horizontal sync signal in SYNC mode. Pull low or floating in DE mode.	
4	Vsync	I	Vertical sync signal in SYNC mode. Pull low or floating in DE mode.	
5	GND	P	Ground	
6	R0	I	Red data (LSB)	
7	R1	I	Red data	
8	R2	I	Red data	
9	R3	I	Red data	
10	R4	I	Red data	
11	R5	I	Red data (MSB)	
12	GND	P	Ground	
13	G0	I	Green data(LSB)	
14	G1	I	Green data	
15	G2	I	Green data	
16	G3	I	Green data	
17	G4	I	Green data	
18	G5	I	Green data(MSB)	
19	GND	P	Ground	
20	B0	I	Blue data(LSB)	
21	B1	I	Blue data	
22	B2	I	Blue data	
23	B3	I	Blue data	
24	B4	I	Blue data	
25	B5	I	Blue data(MSB)	
26	GND	P	Ground	
27	ENABLE	I	Data enable signal in DE mode. This pin must pull high in SYNC mode.	
28	VCC	P	Power supply	
29	VCC	P	Power supply	
30	R/L	I	Set horizontal scan direction: Low/NC: left to right; High: right to left	
31	U/D	I	Set vertical scan direction: High/NC: up to down; Low: down to up	
32	NC	-	No connection	
33	GND	P	Ground	

Note1: I/O definition:

I----Input O----Output P----Power/Ground

Note2: CN1 Matching FPC type: 33 pin, pitch: 0.5mm, height: 0.3mm.



2.2 CN2 pin assignment (Backlight interface)

Connector type: SHLP-06V-S-B (JST)

No	Symbol	I/O	Description	Comment
1	AN1	P	LED driving anode 1 (high voltage)	
2	AN2	P	LED driving anode 2 (high voltage)	
3	AN3	P	LED driving anode 3 (high voltage)	
4	CA1	P	LED driving cathode 1 (low voltage)	
5	CA2	P	LED driving cathode 2 (low voltage)	
6	CA3	P	LED driving cathode 3 (low voltage)	

Note1: CN2 Matching Connector type: SM06B-SHLS-TF (JST)

3 Absolute Maximum Ratings

3.1 Driving TFT LCD Panel

GND=0V, Ta=25°C

Item	Symbol	Min	Max	Unit	Remark
Power Voltage	VCC	-0.5	5.0	V	
Input voltage	V _{IN}	-0.5	5.0	V	Note2
Operating Temperature	Top	-20	70	°C	Note1
Storage Temperature	Tst	-30	85	°C	Note1

Note1: The parameter is for driver IC (gate driver, source driver) only.

Note2: Signals include R0~R5, G0~G5, B0~B5, DOTCLK, Hsync, Vsync, Enable, R/L, U/D.

Table 3.1 absolute maximum rating

4 Electrical Characteristics

4.1 Driving TFT LCD Panel

GND=0V, Ta=25°C

Item	Symbol	Min	Typ	Max	Unit	Remark
Supply Voltage	VCC	3.0	3.3	3.6	V	
Permissible input ripple voltage	V _{RF}	-	-	100	mVp-p	VCC=3.3V
Input Signal Voltage	Low Level	V _{IL}	0	-	0.3xVCC	R0~R5;G0~G5;B0~B5 DOTCLK; Hsync; Vsync ENABLE;R/L;U/D
	High Level	V _{IH}	0.7xVCC	-	VCC	
Common Electrode Driving Signal	VCOM	-	4.56	-	V	Note1
Current of VCC Power supply	I _{VCC}	-	145	225	mA	Note2

Note1: For different LCM, the value may have a bit of difference.

Note2: To test the current dissipation, use "all Black Pattern".

Table 4.1 LCD module electrical characteristics

4.2 Driving Backlight

Item	Symbol	Min	Typ	Max	Unit	Remark
Channel1	I _{channel 1}	-	25.0	-	mA	Note 1
Channel2	I _{channel 2}	-	25.0	-	mA	
Channel3	I _{channel 3}	-	25.0	-	mA	
Forward Voltage	V _{BL}	14.85	-	18.15	V	
Backlight Power Consumption	W _{BL}	-	1,238	-	mW	
Life Time	-	25,000	(50,000)		Hrs	Note 3

Note 1: I_F is defined for one channel LED. There are total three LED channels in back light unit

Note 2: Optical performance should be evaluated at Ta=25°C only.

Note 3: If LED is driven by high current, high ambient temperature & humidity condition. The life time of LED will be reduced. Operating life means brightness goes down to 50% initial brightness. Typical operating life time is estimated data.

Table 4.2 LED backlight characteristics

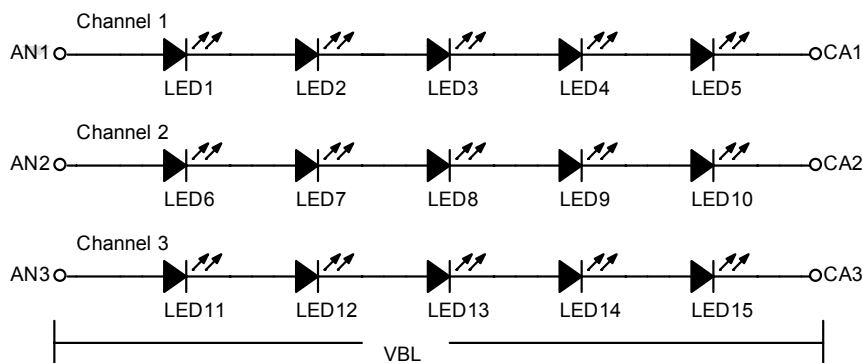
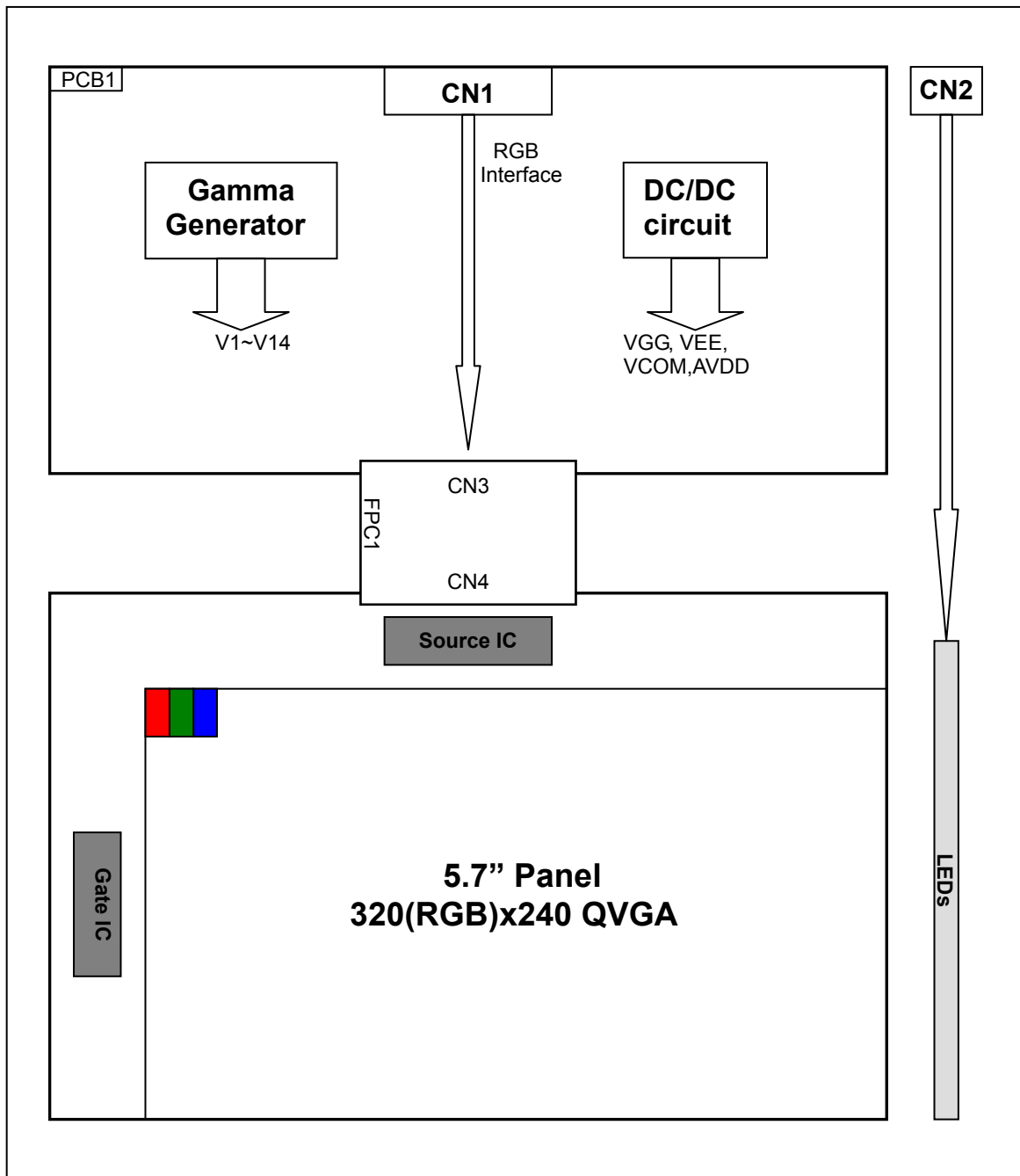

Figure 4.2 LED connection of backlight

4.3 Block Diagram





5. Data input timing

5.1 SYNC mode

Parameter	Symbol	Symbol	Min	Typ	Max	Unit
DOTCLK	DOTCLK frequency	Fclk	6.2	6.4	12.1	MHz
	DOTCLK cycle	Tclk	82.64	156.25	161.29	ns
Hsync	Horizontal display area	Thd	320	320	320	Tclk
	1 horizontal line	Th	406	408	560	Tclk
	Hsync pulse width	Thpw	1	-	-	Tclk
	Horizontal blanking	Thb	70	70	70	Tclk
	Horizontal front porch	Thfp	16	18	170	Tclk
Vsync	Frame rate	-	-	60	65	Hz
	Vertical display area	Tvd	240	240	240	Th
	Vsync period time	Tv	254	263	360	Th
	Vsync pulse width	Tvpw	1	-	-	Th
	Vsync blanking	Tvb	13	13	13	Th
	Vsync front porch	Tvfp	1	10	107	Th

Table 5.1 SYNC mode

5.2 DE mode

Description		Symbol	Min.	Typ.	Max.	Unit
DOTCLK frequency		Fclk	6.2	6.4	12.1	MHz
Horizontal section	Horizontal total	Th	406	408	560	Tclk
	H Total blank	Thb+Thfp	86	88	240	Tclk
	Valid Data Width	Thd	320	320	320	Tclk
Vertical section	Frame rate	-	-	60	65	Hz
	Vertical total	Tv	254	263	360	Th
	V total blank	Tvb+Tvfp	14	23	120	Th
	Valid Data Width	Tvd	240	240	240	Th

Note: The LCM could auto-detect which mode is working.

Table 5.2 DE mode

5.3 Timing Diagram

5.3.1 Vertical Input Timing

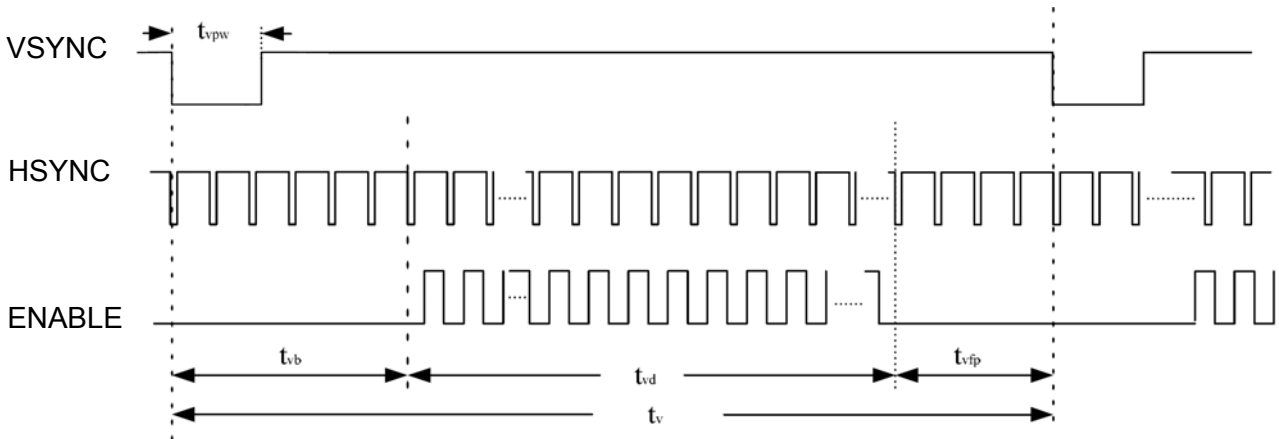

5.3.2 Horizontal Input Timing

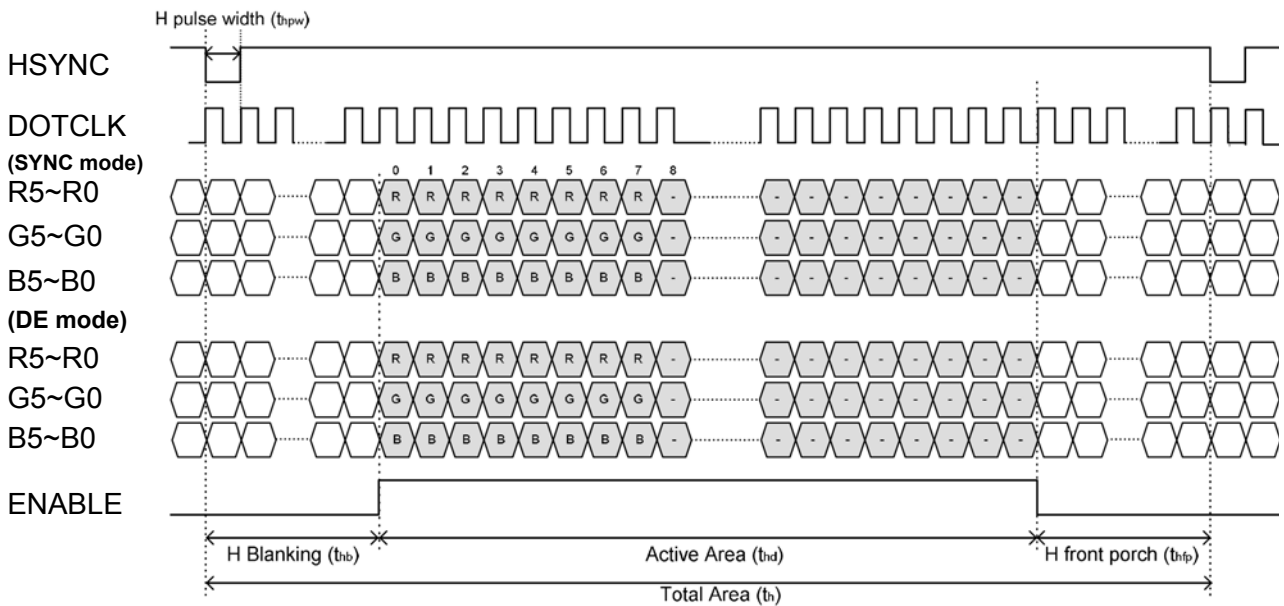



5.4 AC input characteristics

(VCC=3.3V, GND=0V, Ta=25°C)

Parameter	Symbol	Min	Typ	Max	Unit	Conditions
DOTCLK pulse duty	Tcwh	40%	50%	60%	Tclk	Tcph is DCLK cycle
VSYNC setup time	Tvst	10	-	-	ns	
VSYNC hold time	Tvhd	10	-	-	ns	
HSYNC setup time	Thst	10	-	-	ns	
HSYNC hold time	Thhd	10	-	-	ns	
Data setup time	Tdsu	10	-	-	ns	Rn, Gn, Bn to DCLK
Data hold time	Tdhd	10	-	-	ns	Rn, Gn, Bn to DCLK
Enable setup time	Tesu	10			ns	

Table 5.4 AC input characteristics

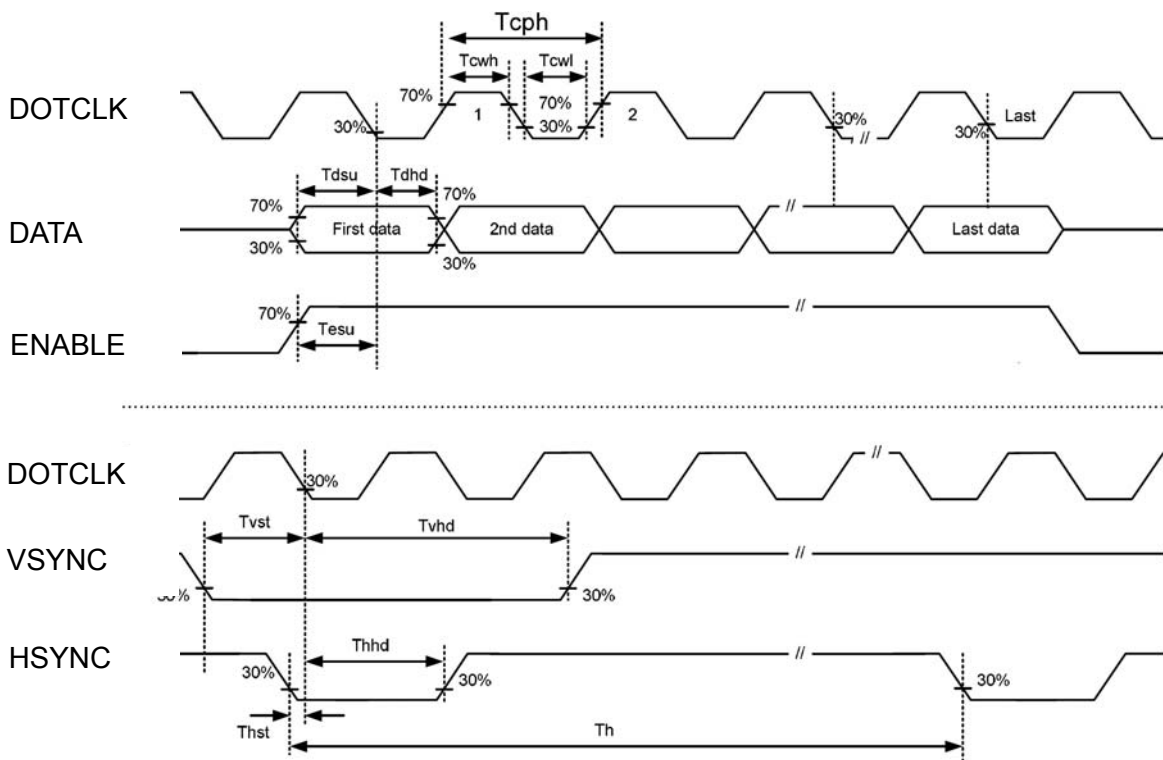
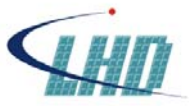

Figure 5.4 AC input characteristics



5.5 Power ON/OFF Sequence

Item	Symbol	Min	Typ	Max	Unit	Remark
VCC 3.0V to signal starting	Tp1	5	-	50	ms	
Signal starting to backlight on	Tp2	50	-	-	ms	
Signal off to VCC 3.0V	Tp3	5	-	50	ms	
Backlight off to signal off	Tp4	50	-	-	ms	

Table 5.5 Power on/off sequence

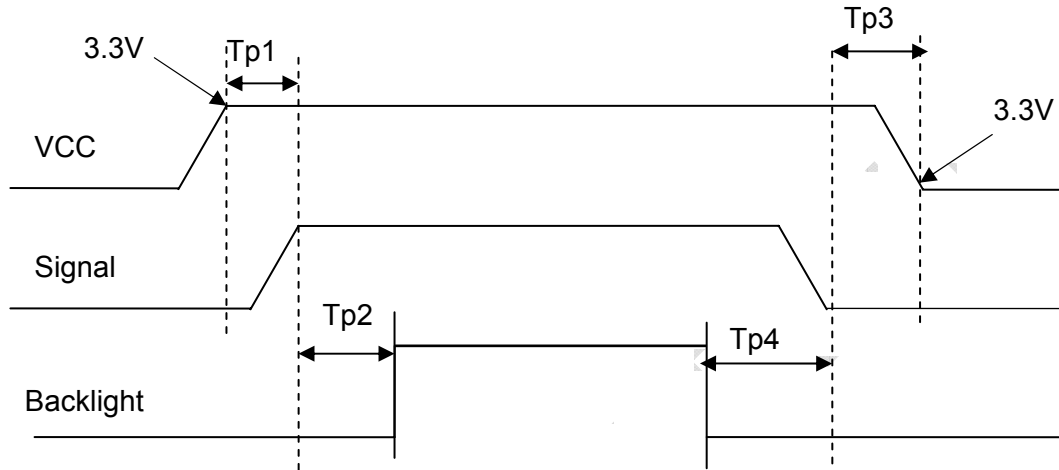

Figure 5.5 Power on/off sequence



6. Optical Characteristics

Item	Symbol	Condition	Min	Typ	Max	Unit	Remark
View Angles	θT	$CR \geq 10$	60	70	--	Degree	Note 2
	θB		50	60	--		
	θL		60	70	--		
	θR		60	70	--		
Contrast Ratio	CR	$\theta=0^\circ$	400	500	--		Note1、Note3
Response Time	T_{ON}	25°C	--	20	30	ms	Note1
	T_{OFF}						Note4
Chromaticity	White	Backlight is on	x	0.274	0.324	0.374	Note5 Note1
			y	0.279	0.362	0.379	
	Red		x	0.566	0.616	0.666	
			y	0.303	0.353	0.403	
	Green		x	0.285	0.335	0.385	
			y	0.526	0.576	0.626	
	Blue		x	0.086	0.136	0.186	
			y	0.076	0.126	0.176	
Uniformity	U		75	80	--	%	Note1、Note6
NTSC			--	50	--	%	Note 5
Luminance	L		320	400	--	cd/m ²	Note1、Note7

Test Conditions:

1. $I_F = 25mA$ (one channel), $V_F = 16.5V$, the ambient temperature is 25°C.
2. The test systems refer to Note 1 and Note 2.

Note 1: Definition of optical measurement system.

The optical characteristics should be measured in dark room. After 5 Minutes operation, the optical properties are measured at the center point of the LCD screen. All input terminals LCD panel must be ground when measuring the center area of the panel.

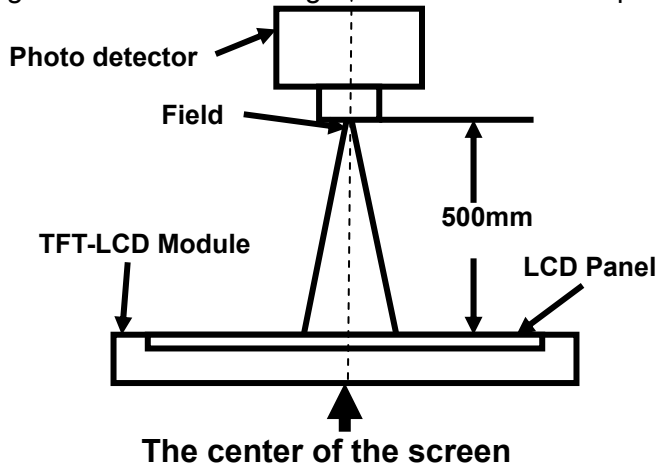

Item	Photo detector	Field
Contrast Ratio	SR-3A	1°
Luminance		
Chromaticity		
Lum Uniformity		
Response Time	BM-7A	2°

Note 2: Definition of viewing angle range and measurement system.

viewing angle is measured at the center point of the LCD by CONOSCOPE(ergo-80).

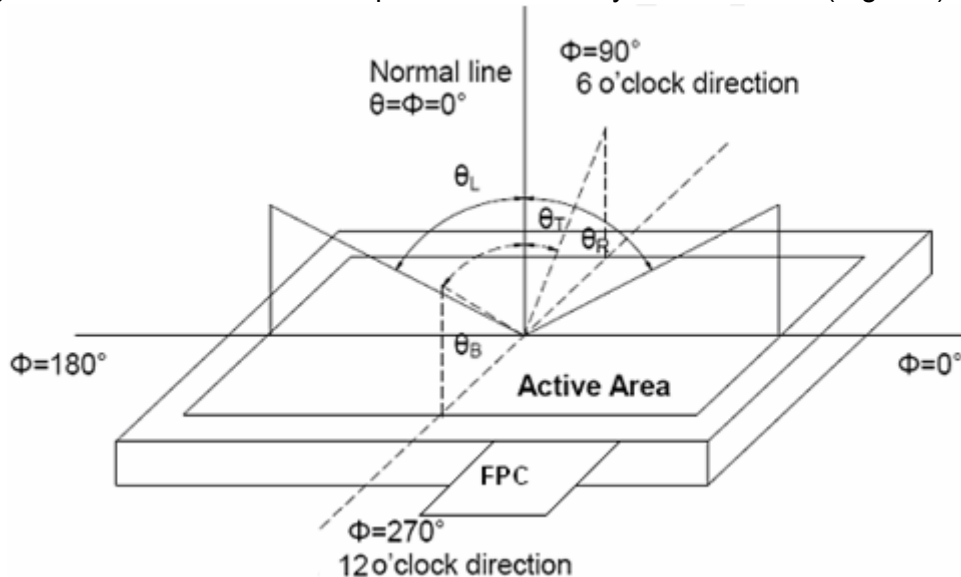

Note 3: Definition of contrast ratio

$$\text{Contrast ratio (CR)} = \frac{\text{Luminance measured when LCD is on the "White" state}}{\text{Luminance measured when LCD is on the "Black" state}}$$

“White state “: The state is that the LCD should drive by V_{white} .

“Black state”: The state is that the LCD should drive by V_{black} .

V_{white} : To be determined V_{black} : To be determined.

Note 4: Definition of Response time

The response time is defined as the LCD optical switching time interval between “White” state and “Black” state. Rise time (T_{ON}) is the time between photo detector output intensity changed from 90% to 10%. And fall time (T_{OFF}) is the time between photo detector output intensity changed from 10% to 90%.

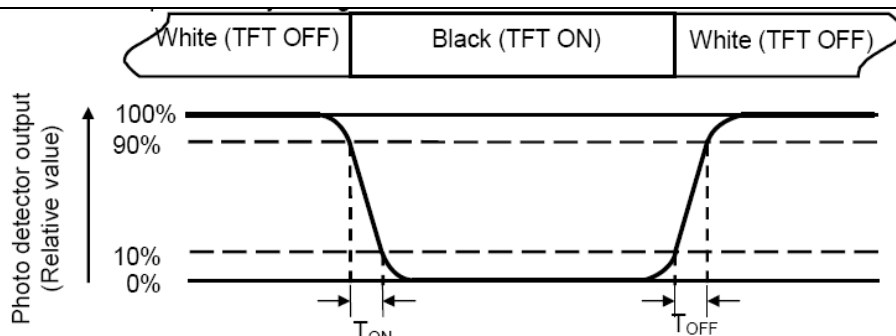

Note 5: Definition of color chromaticity (CIE1931)
 Color coordinates measured at center point of LCD.

Note 6: Definition of Luminance Uniformity

Active area is divided into 9 measuring areas (Refer Fig. 2). Every measuring point is placed at the center of each measuring area.

$$\text{Luminance Uniformity (U)} = L_{\min} / L_{\max}$$

L-----Active area length W----- Active area width

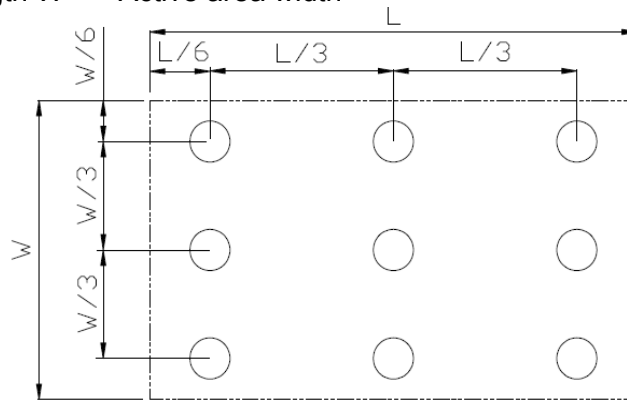

L_{\max} : The measured Maximum luminance of all measurement position.

L_{\min} : The measured Minimum luminance of all measurement position.

Note 7: Definition of Luminance:

Measure the luminance of white state at center point.



7. Environmental / Reliability Test

No	Test Item	Condition	Remarks
1	High Temperature Operation	Ts = +70°C, 240 hours	Note1 IEC60068-2-1,GB2423.2
2	Low Temperature Operation	Ta = -20°C, 240 hours	IEC60068-2-1 GB2423.1
3	High Temperature Storage	Ta = +85°C, 240 hours	IEC60068-2-1 GB2423.2
4	Low Temperature Storage	Ta = -30°C, 240 hours	IEC60068-2-1 GB2423.1
5	Storage at High Temperature and Humidity	Ta = +60°C, 90% RH max,240hours	Note2 IEC60068-2-78 GB/T2423.3
6	Thermal Shock (non-operation)	-20°C 30 min~+60°C 30 min, Change time:5min, 100 Cycle	Start with cold temperature, End with high temperature, IEC60068-2-14,GB2423.22
7	ESD	C=150pF,R=330Ω,5point/panel Air:±15Kv,5times; Contact:±8Kv,5times (Environment:15°C~35°C 30%~60%.86Kpa~106Kpa)	IEC61000-4-2 GB/T17626.2
8	Vibration Test	Frequency range:10~200Hz Stroke:1.5mm Sweep:10Hz~200Hz~10Hz 30 minutes for each direction of X.Y.Z. (1.5 hours for total)	IEC60068-2-6 GB/T2423.10
9	Mechanical Shock (Non Op)	Half Sine Wave 50G 20ms, ±X,±Y,±Z 3times for each direction	IEC60068-2-27 GB/T2423.5
10	Package Drop Test	Height:80cm, 1corner,3edges,6surfaces	IEC60068-2-32 GB/T2423.8
11	Package Vibration Test	Random Vibration: 0.015G*G/Hz for 5-200Hz, -6dB/Octave from 200-500Hz 2 hours for each direction of X,Y,Z (6 hours for total)	IEC60068-2-34 GB/T2423.11

Note1: Ts is the temperature of panel's surface.

Note2: Ta is the ambient temperature of samples.

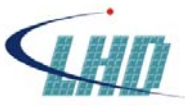

8. Mechanical Drawing

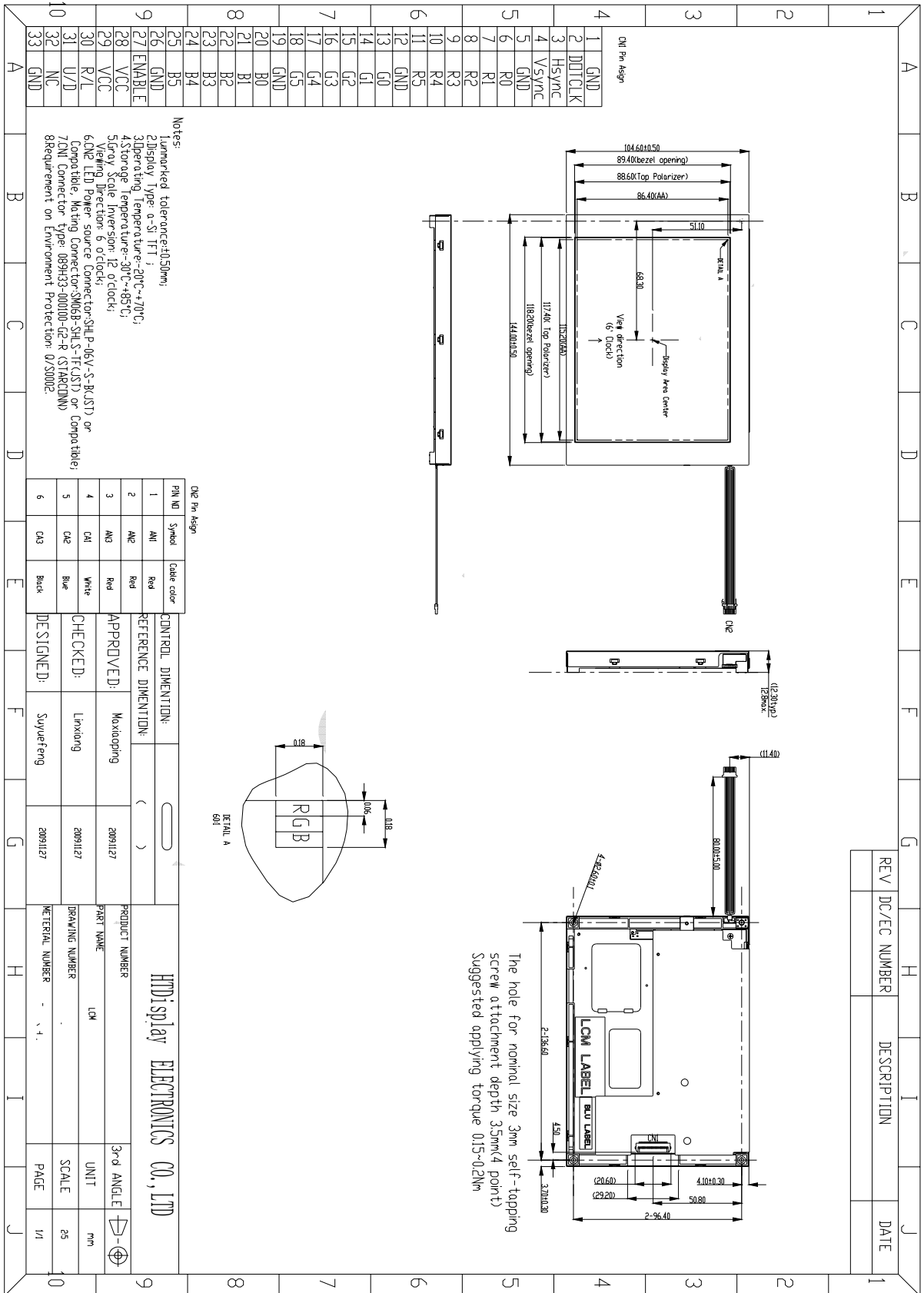

REV	DC/EC NUMBER	DESCRIPTION	DATE

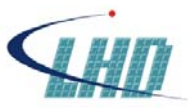

9. Packing Drawing

No	Item	Model(Material)	Dimensions (mm)	Unit Weight (Kg)	Quantity	Remark
1	LCM module	HT320057B	144X104.6X12.3	0.160	40	
2	Partition_1	Corrugated paper	513X333X215	1.388	1	
3	Anti-static Bag	PE	180X165X0.05	0.001	40	Anti-static
4	Dust-Proof Bag	PE	700X530	0.06	1	
5	Partition_2	Corrugated Paper	505X332X4.0	0.098	2	
6	Corrugated Bar	Corrugated paper	513X110×31	0.048	4	
7	Carton	Corrugated paper	530X350X250	1.12	1	
8	Total weight	$9.396 \pm 5\%$				

