

Display Elektronik GmbH

DATA SHEET

TFT MODULE

**DEM 480272E TMH-PW-N
(A-TOUCH)**

4,3“ TFT + TP

Product Specification

Ver.: 1.1.1

24.05.2013

REVISION RECORD

REV NO.	REV DATE	CONTENTS	REMARKS
0	19.12.2012	PRELIMINARY	-
1	19.12.2012	FIRST RELEASE	-
1.1.1	24.05.2013	CHANGE PARAMETER	-

CONTENTS

n GENERAL INFORMATION 4

n ABSOLUTE MAXIMUM RATINGS 4

n ELECTRICAL CHARACTERISTICS 4

n BACKLIGHT CHARACTERISTICS..... 4

n EXTERNAL DIMENSIONS 5

n ELECTRO-OPTICAL CHARACTERISTICS 6

n INTERFACE DESCRIPTION 8

n AC CHARACTERISTICS..... 9

n POWER SEQUENCE 11

n REFERENCE APPLICATION CIRCUIT..... 12

n RELIABILITY TEST CONDITIONS..... 13

n INSPECTION CRITERION 14

n GENERAL INFORMATION

Item of General Information	Contents	Unit
LCD Size	4.3 Inch (Digital) + 4-Wire-Resistive-Touch-Panel	-
LCD Type	TFT TRANSMISSIVE Normal White	-
View Direction	12 o'clock	-
Resolution	480 x RGB x 272	Dots
Module Size (W × H×T)	105.50 x 67.20 x 4.15	mm
Active Area (W×H)	95.04 x 53.86	mm
Pixel Pitch (W × H)	0.198 x 0.198	mm
Interface Type	RGB Interface	-
Input Voltage	3.3 Volt (typ.)	V
Module Power Consumption	TBD	mW
Backlight Type	7 x LEDs	-

n ABSOLUTE MAXIMUM RATINGS

Parameter	Symbol	Min	Max	Unit
Power Supply Voltage	DV _{DD}	-0.3	3.6	V
Logic Signal Input Level	V _i	-0.3	DV _{DD} +0.3	V
Operating Temperature	T _{op}	-20	70	°C
Storage Temperature	T _{ST}	-30	80	°C
Humidity	RH	-	90% (Max60 °C)	RH

n ELECTRICAL CHARACTERISTICS

DC CHARACTERISTICS

Parameter	Symbol	Min	Typ	Max	Unit
Supply Voltage	V _{DD}	3.0	3.3	3.6	V
Current of power supply	I _{V_{DD}}	-	TBD	-	mA
Input voltage 'H' level	V _{IH}	0.7DV _{DD}	-	V _{DD}	V
Input voltage 'L' level	V _{IL}	0	-	0.3V _{DD}	V

Note: Be sure to apply DV_{DD} and VG_L to the LCD first , then apply VG_H.

n BACKLIGHT CHARACTERISTICS

Item of backlight characteristics	Symbol	Min.	Typ.	Max.	Unit	Condition
Forward voltage	V _f	-	22.4	23.1	V	Note 1
Current for LED backlight	I _L	-	20	22	mA	Note 1
LED life time		20,000	-	-	Hour	Note 2

Note 1: The LED Supply Voltage is defined by the number of LED at Ta=25°C and I_L =20mA for each LED.

Note 2: The “LED life time” is defined as the module brightness decrease to 50% original brightness at Ta=25°C and I_L =20mA. The LED lifetime could be decreased if operating I_L is larger than 20 mA.

n EXTERNAL DIMENSIONS

PIN	NAME
1	LEDK
2	LEDA
3	GND
4	VDD
5	R0
6	R1
7	R2
8	R3
9	R4
10	R5
11	R6
12	R7
13	G0
14	G1
15	G2
16	G3
17	G4
18	G5
19	G6
20	G7
21	B0
22	B1
23	B2
24	B3
25	B4
26	B5
27	B6
28	B7
29	GND
30	DCLK
31	DISP
32	HSYNC
33	YSYNC
34	DE
35	NC
36	GND
37	XR
38	Y0
39	XL
40	YU

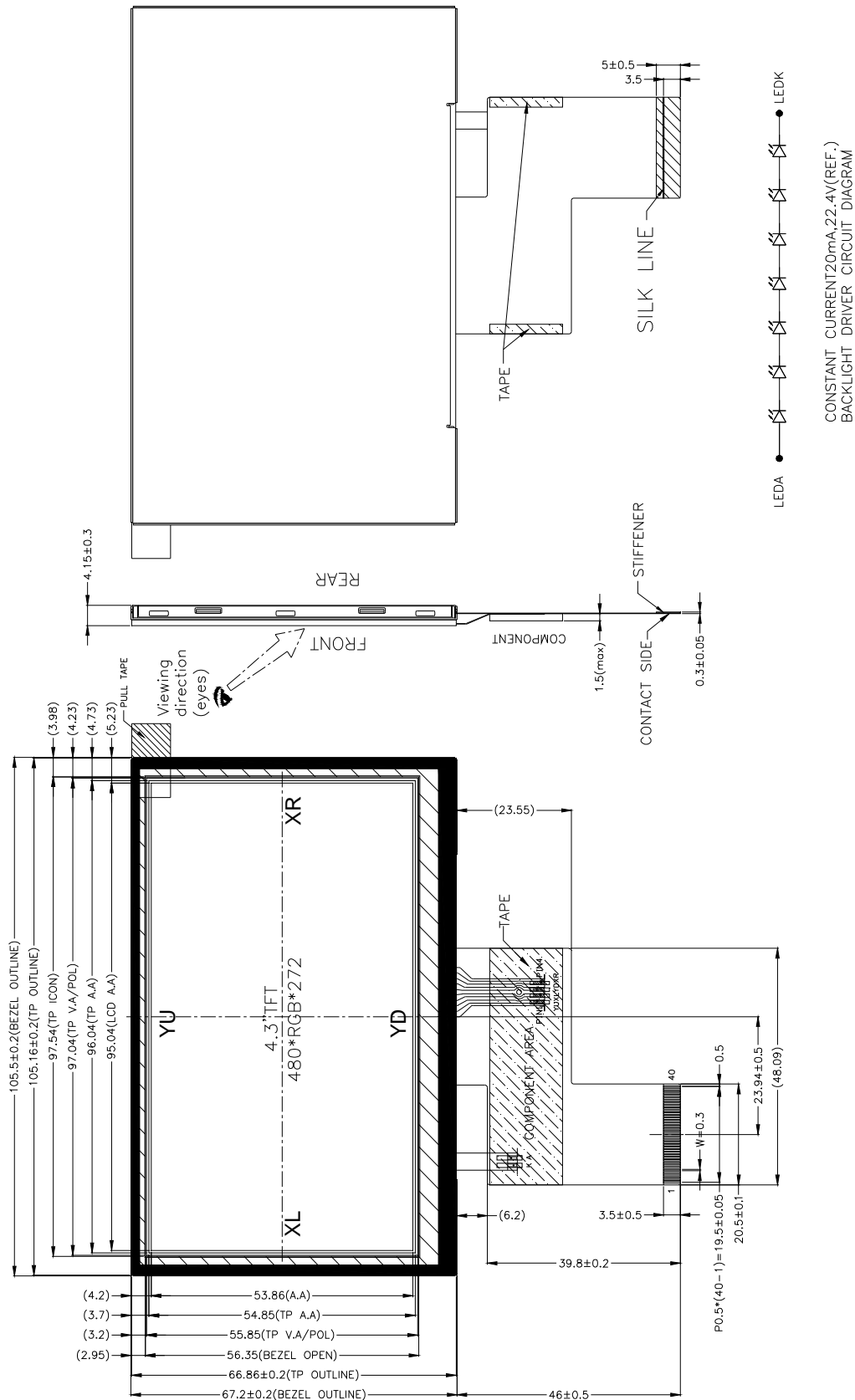

n ELECTRO-OPTICAL CHARACTERISTICS

Item of Electro-Optical Characteristics	Symbol	Condition	Min	Typ	Max	Unit	Remark	Note
Response Time	Tr+ Tf		–	25	50	ms	Fig.1	4
Contrast Ratio	Cr		400	500	–	---	FIG 2.	1
Luminance Uniformity	δ WHITE		60	75	–	%	FIG 2.	3
Surface Luminance	Lv		180	220	–	cd/m ²	FIG 2.	2
Viewing Angle Range	θ	∅ = 90°	–	50	–	deg	FIG 3.	6
		∅ = 270°	–	45	–	deg	FIG 3.	
		∅ = 0°	–	60	–	deg	FIG 3.	
		∅ = 180°	–	60	–	deg	FIG 3.	
CIE (x, y) Chromaticity	Red x	θ=0° ∅=0° Ta=25°C	0.590	0.620	0.650	-	FIG 2.	5
	Red y		0.314	0.344	0.374	-		
	Green x		0.276	0.306	0.336	-		
	Green y		0.533	0.563	0.593	-		
	Blue x		0.103	0.133	0.163	-		
	Blue y		0.119	0.149	0.179	-		
	White x		0.281	0.311	0.341	-		
	White y		0.319	0.349	0.379	-		

Note1. Contrast Ratio(CR) is defined mathematically by the following formula. For more information see FIG 2.:

$$\text{Contrast Ratio} = \frac{\text{Average Surface Luminance with all white pixels (P1, P2, P3, P4, P5)}}{\text{Average Surface Luminance with all black pixels (P1, P2, P3, P4, P5)}}$$

Note2. Surface luminance is the LCD surface from the surface with all pixels displaying white. For more information see FIG 2.

$$L_v = \text{Average Surface Luminance with all white pixels (P1, P2, P3, P4, P5)}$$

Note3. The uniformity in surface luminance (δ WHITE) is determined by measuring luminance at each test position 1 through 5, and then dividing the maximum luminance of 5 points luminance by minimum luminance of 5 points luminance. For more information see FIG 2.

$$\delta \text{ WHITE} = \frac{\text{Minimum Surface Luminance with all white pixels (P1, P2, P3, P4, P5)}}{\text{Maximum Surface Luminance with all white pixels (P1, P2, P3, P4, P5)}}$$

Note4. Response time is the time required for the display to transition from White to black(Rise Time, Tr) and from black to white(Decay Time, Tf). For additional information see FIG 1..

Note5. CIE (x, y) chromaticity, The x,y value is determined by screen active area position NO.5 For more information see FIG 2.

Note6. Viewing angle is the angle at which the contrast ratio is greater than 2. For TFT module the contrast ratio is greater than 10. The angles are determined for the horizontal or x axis and the vertical or y axis with respect to the z axis which is normal to the LCD surface. For more information see FIG 3.

Note7. For Viewing angle and response time testing, the testing data is base on Autronic-Melchers's ConoScope. Series Instruments. For contrast ratio, Surface Luminance, Luminance uniformity and CIE, the testing data is base on TOPCON's BM-5 photo detector or compatible.

Note8. For TFT module, Gray scale reverse occurs in the direction of panel viewing angle

FIG.1. The Definition of Response Time

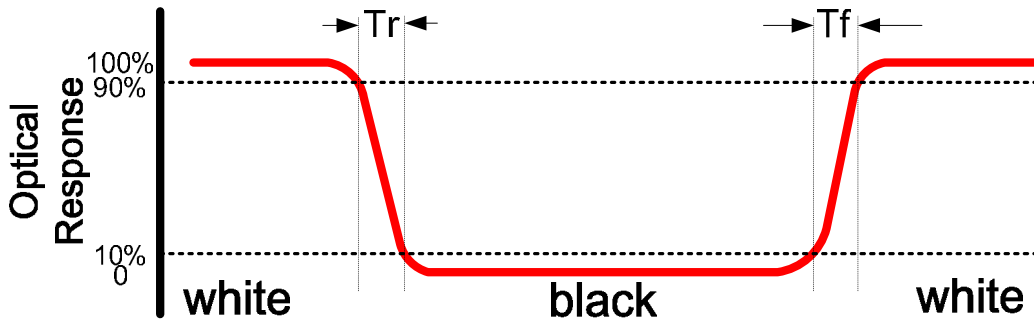

FIG.2. Measuring method for Contrast ratio, surface luminance, Luminance uniformity, CIE (x, y) chromaticity

A : 5 mm
 B : 5 mm
 H, V : Active Area
 Light spot size $\varnothing=5\text{mm}$, 500mm distance from the LCD surface to detector lens
 measurement instrument is TOPCON's luminance meter BM-5

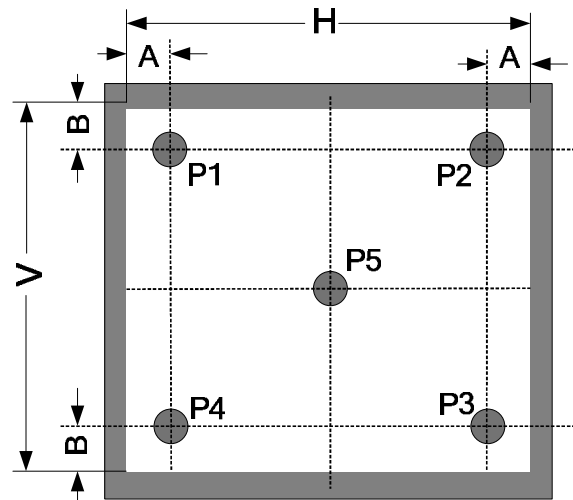
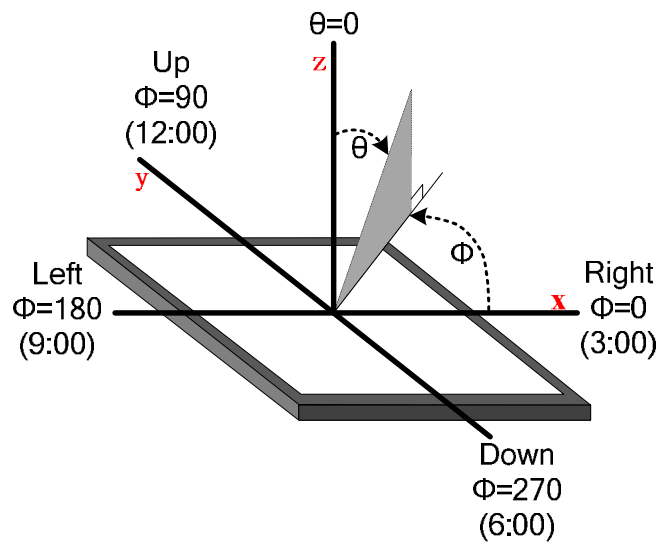

FIG.3. The definition of viewing angle



n INTERFACE DESCRIPTION

Interface NO.	NAME	I/O or connect to	DESCRIPTION
1	LEDK	P	Power for LED backlight(Cathode)
2	LEDA	P	Power for LED backlight(Anode)
3	GND	P	Ground
4	VDD	P	Power for LCD
5-12	Red(0-7)	I	Red data
13-20	Green(0-7)	I	Green data
21-28	Blue(0-7)	I	Blue data
29	GND	I	Ground
30	DCLK	I	Data Enable signal ;normally pull low
31	DISP	I	Display on/off
32	HSYNC	I	Horizontal sync input.
33	VSYNC	I	Vertical sync input
34	DE	I	Data enable
35	NC	/	/
36	GND	p	Ground
37	XR	O	Touch panel X right
38	YD	O	Touch panel Y down
39	XL	O	Touch panel X left
40	YU	O	Touch panel Y up

n AC CHARACTERISTICS

Item	Symbol	Min	Typ	Max	Unit	Remark
HS setup time	Thst	8	-	-	ns	
HS hold time	Thhd	8	-	-	ns	
VS setup time	Tvst	8	-	-	ns	
VS hold time	Tvhd	8	-	-	ns	
Data setup time	Tdsu	8	-	-	ns	
Data hold time	Tdhd	8	-	-	ns	
DE setup time	Tesu	8	-	-	ns	
DE hold time	Tehd	8	-	-	ns	
Dvdd power on slew rate	Tpor	-	-	20	ms	0 to 90% DVDD
RESET pulse width	Trst	1	-	-	us	
DCLK cycle time	Tcoh	20	-	-	ns	
DCLK pulse duty	Tcwh	40	50	60	%	

Timing Diagram of Interface Signal

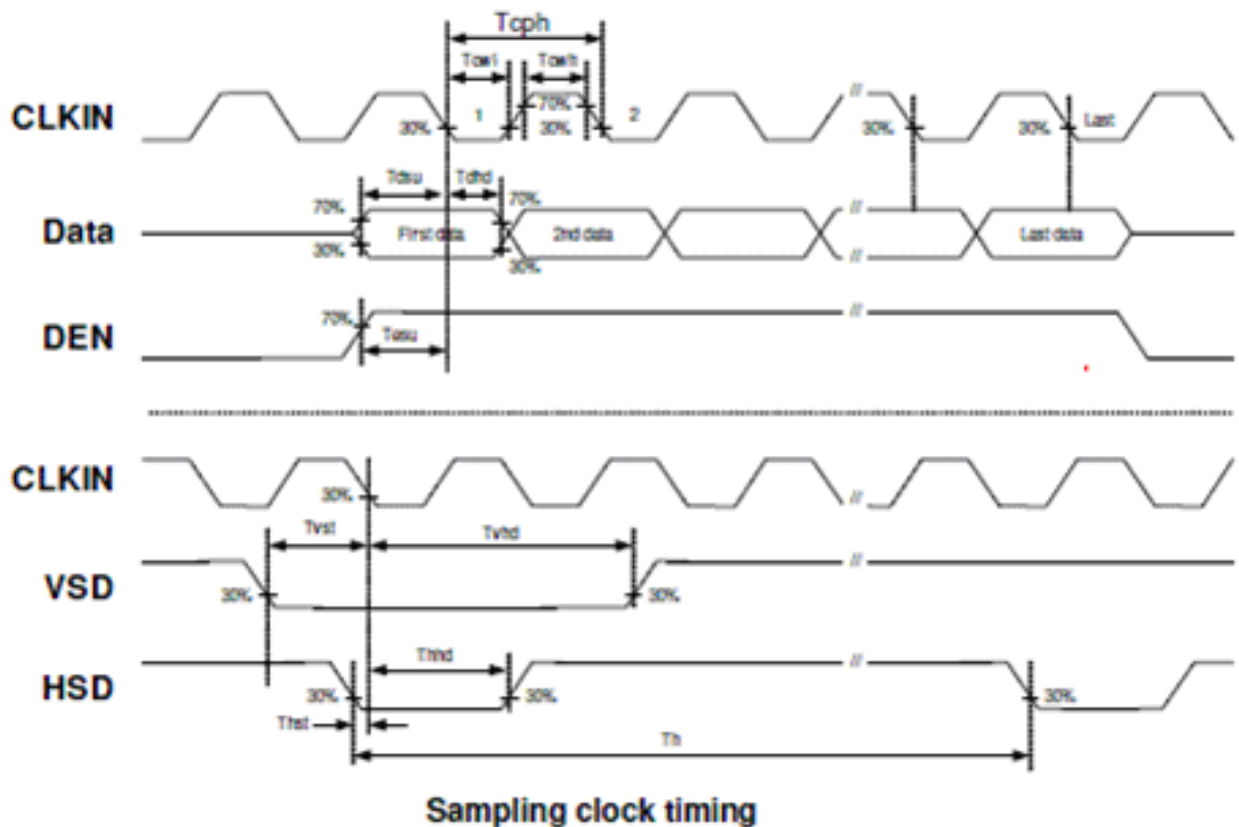

Item	Symbol	Min	Typ	Max	Unit	Remark
Horizontal Display Area	thd		480		DCLK	
Dclk frequency	fclk	5	9	15	MHZ	
One horizontal line	th	490	531	605	DCLK	
HS pulse width	thpw	1	-	-	DCLK	
HS blanking	thb	8	43	-	DCLK	
HS front porch	thfp	2	8	-	DCLK	
Vertical Display Area	tvd		272		TH	
VS period time	tv	275	288	335	TH	
VS pulse width	tvpw	1	10	-	TH	
VS blanking	tvb	2	12	-	TH	
VS front porch	tvfp	1	4	-	TH	

Horizontal input timing diagram.



Vertical input timing diagram.

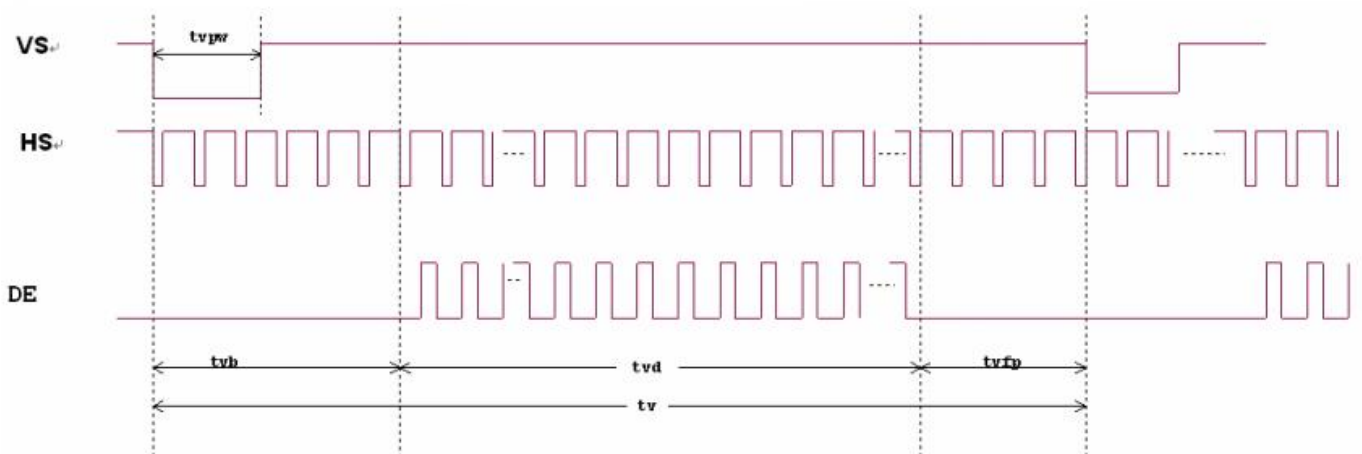

n POWER SEQUENCE

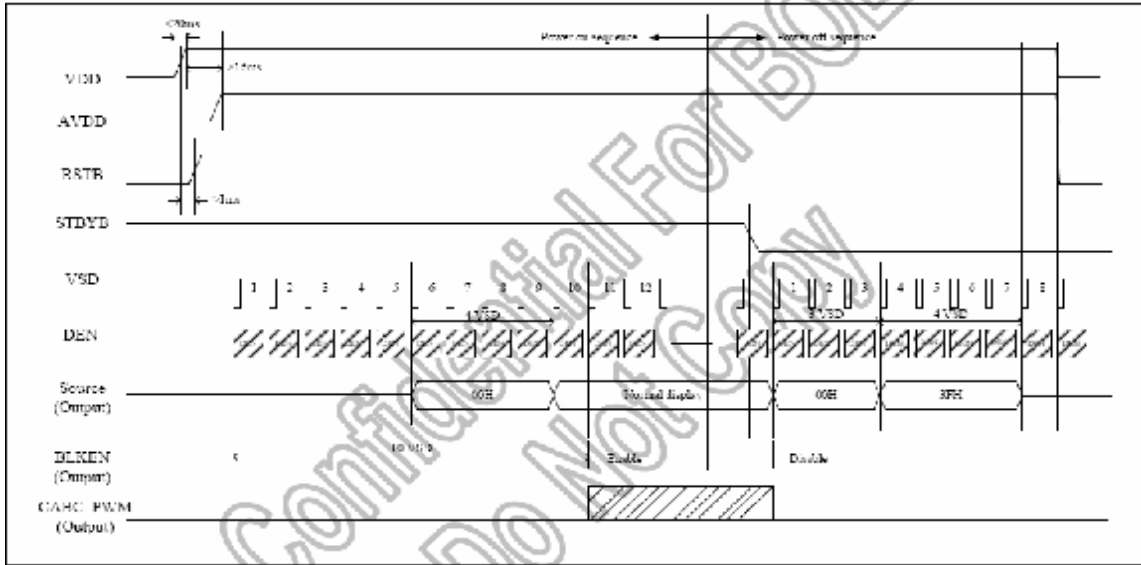

n REFERENCE APPLICATION CIRCUIT

Please consult our technical department for detail information.

n RELIABILITY TEST CONDITIONS

No.	Test Item	Test Condition	Inspection after test
1	High Temperature Storage	80± 2°C/240 hours	Inspection after 2~4hours storage at room temperature, the sample shall be free from defects: 1.Air bubble in the LCD; 2.Sealleak; 3.Non-display; 4.missing segments; 5.Glass crack; 6.Current Idd is twice higher than initial value.
2	Low Temperature Storage	-30± 2°C/240 hours	
3	High Temperature Operating	70± 2°C/120 hours	
4	Low Temperature Operating	-20± 2°C/120 hours	
5	Temperature Cycle	-20± 2°C~25~70± 2°C × 10cycles (30min.) (5min.) (30min.)	
6	Damp Proof Test	50°C ± 5°C × 90%RH/120 hours	
7	Vibration Test	Frequency: 10Hz~55Hz~10Hz Amplitude: 1.5mm, X, Y, Z direction for total 3hours (Packing condition)	
8	Dropping test	Drop to the ground from 1m height, one time, every side of carton. (Packing condition)	
9	ESD test	Voltage:±8KV R: 330Ω C: 150pF Air discharge, 10time	

Remark:

- 1.The test samples should be applied to only one test item.
- 2.Sample size for each test item is 5~10pcs.
- 3.For Damp Proof Test, Pure water(Resistance> 10MΩ) should be used.
- 4.In case of malfunction defect caused by ESD damage, if it would be recovered to normal state after resetting, it would be judged as a good part.
- 5.EL evaluation should be excepted from reliability test with humidity and temperature: Some defects such as black spot/blemish can happen by natural chemical reaction with humidity and Fluorescence EL has.
- 6.Failure Judgment Criterion: Basic Specification, Electrical Characteristic, Mechanical Characteristic, Optical Characteristic.

n INSPECTION CRITERION

This specification is made to be used as the standard acceptance/rejection criteria for Normal LCM Product.

1 Sample plan

Sampling plan according to GB/T2828.1-2003/ISO 2859-1: 1999 and ANSI/ASQC Z1.4-1993, normal level 2 and based on:

Major defect: AQL 0.65

Minor defect: AQL 1.5

2. Inspection condition

▮ Viewing distance for cosmetic inspection is about 30cm with bare eyes, and under an environment of 20~40W light intensity, all directions for inspecting the sample should be within 45° against perpendicular line. (Normal temperature 20~25°C and normal humidity 60±15%RH).

▮ Driving voltage

The Vop value from which the most optimal contrast can be obtained near the specified Vop in the specification (Within ±0.5V of the typical value at 25°C.).

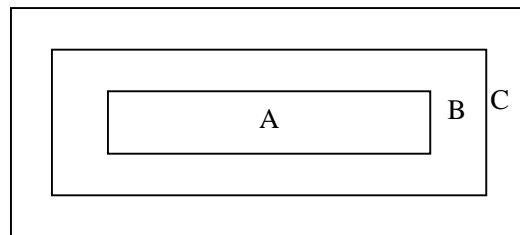
3. Definition of inspection zone in LCD.

Zone A: character/Digit area

Zone B: viewing area except Zone A (ZoneA+ZoneB=minimum Viewing area)

Zone C: Outside viewing area (invisible area after assembly in customer's product)

Fig.1 Inspection zones in an LCD.

Note: As a general rule, visual defects in Zone C are permissible, when it is no trouble for quality and assembly of customer's product.

4. Inspection Standard

4.1 Major Defect

Item No	Items to be inspected	Inspection Standard	Classification of defects
4.1.1	All functional defects	1) No display 2) Display abnormally 3) Missing vertical, horizontal segment 4) Short circuit 5) Back-light no lighting, flickering and abnormal lighting.	Major
4.1.2	Missing	Missing component	
4.1.3	Outline dimension	Overall outline dimension beyond the drawing is not allowed.	

4.2 Cosmetic Defect

4.2.1 Module Cosmetic Criteria

No.	Item	Judgement Criterion	Partition
1	Difference in Spec.	None allowed	Major
2	Pattern peeling	No substrate pattern peeling and floating	Major
3	Soldering defects	No soldering missing No soldering bridge No cold soldering	Major Major Minor
4	Resist flaw on Printed Circuit Boards	visible copper foil (Ø0.5mm or more) on substrate pattern	Minor
5	Accretion of metallic Foreign matter	No accretion of metallic foreign matters (Not exceed Ø0.2mm)	Minor Minor
6	Stain	No stain to spoil cosmetic badly	Minor
7	Plate discoloring	No plate fading, rusting and discoloring	Minor
8	Solder amount	a. Soldering side of PCB Solder to form a 'Filet' all around the lead. Solder should not hide the lead form perfectly. (too much)	Minor
	1. Lead parts	b. Components side (In case of 'Through Hole PCB') Solder to reach the Components side of PCB.	
	2. Flat packages	Either 'Toe' (A) or 'Seal' (B) of the lead to be covered by 'Filet'. Lead form to be assume over solder.	Minor
	3. Chips	$(3/2) H \geq h \geq (1/2) H$	Minor

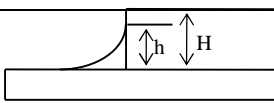
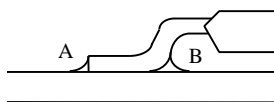
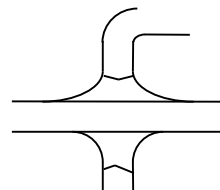

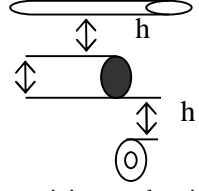
9	Solder ball/Solder splash	<p>a. The spacing between solder ball and the conductor or solder pad $h \geq 0.13\text{mm}$ The diameter of solder ball $d \leq 0.15\text{mm}$.</p> <p>b. The quantity of solder balls or solder Splashes isn't beyond 5 in 600mm^2.</p> <p>c. Solder balls/Solder splashes do not violate minimum electrical clearance.</p> <p>d. Solder balls/Solder splashes must be entrapped/encapsulated Or attached to the metal surface.</p> <p>NOTE: Entrapped/encapsulated/attached is intended to mean that normal service environment of the product will not cause a solder ball to become dislodged.</p>		<p>Minor</p> <p>Minor</p> <p>Major</p> <p>Minor</p>
---	---------------------------	---	---	---

4.2.2 Cosmetic Criteria (Non-Operating)

No.	Defect	Judgment Criterion	Partition										
1	Spots	In accordance with <i>Screen Cosmetic Criteria (Operating) No.1.</i>	Minor										
2	Lines	In accordance with <i>Screen Cosmetic Criteria (Operating) No.2.</i>	Minor										
3	Bubbles in polarizer	<table border="1" data-bbox="499 817 1275 996"> <thead> <tr> <th>Size : d mm</th> <th>Acceptable Qty in active area</th> </tr> </thead> <tbody> <tr> <td>$d \leq 0.3$</td> <td>Disregard</td> </tr> <tr> <td>$0.3 < d \leq 1.0$</td> <td>3</td> </tr> <tr> <td>$1.0 < d \leq 1.5$</td> <td>1</td> </tr> <tr> <td>$1.5 < d$</td> <td>0</td> </tr> </tbody> </table>	Size : d mm	Acceptable Qty in active area	$d \leq 0.3$	Disregard	$0.3 < d \leq 1.0$	3	$1.0 < d \leq 1.5$	1	$1.5 < d$	0	Minor
Size : d mm	Acceptable Qty in active area												
$d \leq 0.3$	Disregard												
$0.3 < d \leq 1.0$	3												
$1.0 < d \leq 1.5$	1												
$1.5 < d$	0												
4	Scratch	In accordance with spots and lines operating cosmetic criteria. When the light reflects on the panel surface, the scratches are not to be remarkable.	Minor										
5	Allowable density	Above defects should be separated more than 30mm each other.	Minor										
6	Coloration	Not to be noticeable coloration in the viewing area of the LCD panels. Back-lit type should be judged with back-lit on state only.	Minor										
7	Contamination	Not to be noticeable.	Minor										

4.2.3 Cosmetic Criteria (Operating)

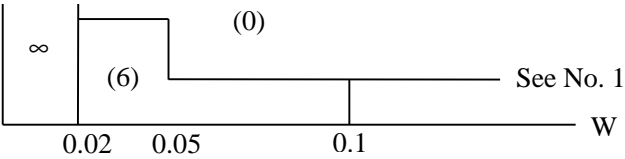
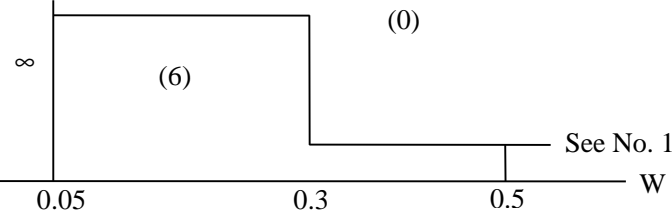
No.	Defect	Judgment Criterion	Partition																																												
1	Spots	<p>A) Clear</p> <table border="1" data-bbox="427 331 1262 667"> <thead> <tr> <th>Lcd size</th> <th>Size : d mm</th> <th>Acceptable Qty in active area</th> </tr> </thead> <tbody> <tr> <td rowspan="4">Lcd size ≤ 8.0'</td> <td>d ≤ 0.1</td> <td>Disregard</td> </tr> <tr> <td>0.1 < d ≤ 0.2</td> <td>6</td> </tr> <tr> <td>0.2 < d ≤ 0.3</td> <td>2</td> </tr> <tr> <td>0.3 < d</td> <td>0</td> </tr> <tr> <td rowspan="4">Lcd size > 8.0'</td> <td>d ≤ 0.1</td> <td>Disregard</td> </tr> <tr> <td>0.1 < d ≤ 0.3</td> <td>10</td> </tr> <tr> <td>0.3 < d ≤ 0.5</td> <td>5</td> </tr> <tr> <td>0.5 < d</td> <td>0</td> </tr> </tbody> </table> <p>Note : Including pin holes and defective dots which must be within one pixel size; Total defective point shall not exceed 6 pcs no more than 8 inch LCD and 10PCS for more than 8 inch LCD.</p> <p>B) Unclear</p> <table border="1" data-bbox="427 857 1262 1238"> <thead> <tr> <th>Lcd size</th> <th>Size : d mm</th> <th>Acceptable Qty in active area</th> </tr> </thead> <tbody> <tr> <td rowspan="4">Lcd size ≤ 8.0'</td> <td>d ≤ 0.2</td> <td>Disregard</td> </tr> <tr> <td>0.2 < d ≤ 0.5</td> <td>6</td> </tr> <tr> <td>0.5 < d ≤ 0.7</td> <td>2</td> </tr> <tr> <td>0.7 < d</td> <td>0</td> </tr> <tr> <td rowspan="5">Lcd size > 8.0'</td> <td>d ≤ 0.2</td> <td>Disregard</td> </tr> <tr> <td>0.2 < d ≤ 0.5</td> <td>10</td> </tr> <tr> <td>0.5 < d ≤ 0.7</td> <td>3</td> </tr> <tr> <td>0.7 < d ≤ 1.0</td> <td>1</td> </tr> <tr> <td>1.0 < d</td> <td>0</td> </tr> </tbody> </table> <p>Note : Total defective point shall not exceed 6 pcs for no more than 8 inch LCD and 10PCS for more than 8 inch LCD.</p>	Lcd size	Size : d mm	Acceptable Qty in active area	Lcd size ≤ 8.0'	d ≤ 0.1	Disregard	0.1 < d ≤ 0.2	6	0.2 < d ≤ 0.3	2	0.3 < d	0	Lcd size > 8.0'	d ≤ 0.1	Disregard	0.1 < d ≤ 0.3	10	0.3 < d ≤ 0.5	5	0.5 < d	0	Lcd size	Size : d mm	Acceptable Qty in active area	Lcd size ≤ 8.0'	d ≤ 0.2	Disregard	0.2 < d ≤ 0.5	6	0.5 < d ≤ 0.7	2	0.7 < d	0	Lcd size > 8.0'	d ≤ 0.2	Disregard	0.2 < d ≤ 0.5	10	0.5 < d ≤ 0.7	3	0.7 < d ≤ 1.0	1	1.0 < d	0	Minor
Lcd size	Size : d mm	Acceptable Qty in active area																																													
Lcd size ≤ 8.0'	d ≤ 0.1	Disregard																																													
	0.1 < d ≤ 0.2	6																																													
	0.2 < d ≤ 0.3	2																																													
	0.3 < d	0																																													
Lcd size > 8.0'	d ≤ 0.1	Disregard																																													
	0.1 < d ≤ 0.3	10																																													
	0.3 < d ≤ 0.5	5																																													
	0.5 < d	0																																													
Lcd size	Size : d mm	Acceptable Qty in active area																																													
Lcd size ≤ 8.0'	d ≤ 0.2	Disregard																																													
	0.2 < d ≤ 0.5	6																																													
	0.5 < d ≤ 0.7	2																																													
	0.7 < d	0																																													
Lcd size > 8.0'	d ≤ 0.2	Disregard																																													
	0.2 < d ≤ 0.5	10																																													
	0.5 < d ≤ 0.7	3																																													
	0.7 < d ≤ 1.0	1																																													
	1.0 < d	0																																													
2	Lines	<p>A) Clear</p>  <p>Note : () - Acceptable Qty in active area L - Length (mm) W - Width (mm) ∞ - Disregard</p> <p>B) Unclear</p>  <p>'Clear' = The shade and size are not changed by V_{op}. 'Unclear' = The shade and size are changed by V_{op}.</p>	Minor																																												

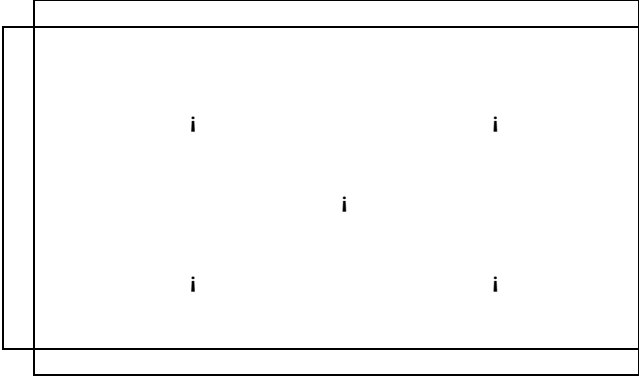
3	Rubbing line	Not to be noticeable.	Minor
4	Allowable density	Above defects should be separated more than 10mm each other.	Minor
5	Rainbow	Not to be noticeable.	Minor
6	Dot size	To be 95% ~ 105% of the dot size (Typ.) in drawing. Partial defects of each dot (ex. pin-hole) should be treated as 'Spot'. (see <i>Screen Cosmetic Criteria (Operating) No.1</i>)	Minor
7	Uneven brightness (only back-lit type module)	<p>Uneven brightness must be $B_{MAX} / B_{MIN} \leq 2$</p> <ul style="list-style-type: none"> - B_{MAX} : Max. value by measure in 5 points - B_{MIN} : Min. value by measure in 5 points <p>Divide active area into 4 vertically and horizontally. Measure 5 points shown in the following figure.</p>  <p style="text-align: center;">i : Measuring points</p>	Minor

Note :

- (1) Size : $d = (\text{long length} + \text{short length}) / 2$
- (2) The limit samples for each item have priority.
- (3) Complex defects are defined item by item, but if the numbers of defects are defined in above table, the total number should not exceed 10.
- (4) In case of 'concentration', even the spots or the lines of 'disregarded' size should not allowed. Following three situations should be treated as 'concentration'.
 - 7 or over defects in circle of $\varnothing 5\text{mm}$.
 - 10 or over defects in circle of $\varnothing 10\text{mm}$.
 - 20 or over defects in circle of $\varnothing 20\text{mm}$.