

**Display Elektronik GmbH**

**DATA SHEET**

**TFT MODULE**

**DEM 1024600E TMH-PW-N  
(C-TOUCH)**

**7,0“ TFT + PCT**

*Product Specification*

*Ver.: 1*

**16.02.2017**



# Contents

<b>1. General Description and Features .....</b>	<b>4</b>
1.1. Features	4
1.2. LCD Module	4
<b>2. Mechanical Information .....</b>	<b>4</b>
<b>3. Electrical Specifications .....</b>	<b>5</b>
3.1 Absolute Max. Ratings	5
3.2 Electrical Absolute Rating	5
<b>4. Electrical Characteristics.....</b>	<b>6</b>
4.1. TFT-LCD Module	6
4.2. Backlight Unit	11
<b>5. Input Terminal Pin Assignment.....</b>	<b>12</b>
5.1. Pin Assignment (LCD)	12
5.2. Pin Assignment (Backlight unit)	13
<b>6. Optical Characteristics .....</b>	<b>14</b>
<b>7. Projected capacitive touch Screen Panel Specifications.....</b>	<b>16</b>
7.1. Touch Panel	16
7.2. DC Characteristics	16
7.3. Pin Assignments and Definitions.	16
7.4. FUNCTIONAL DESCRIPTION	17
<b>8. Reliability Condition .....</b>	<b>18</b>
<b>9. DIMENSIONAL OUTLINE .....</b>	<b>19</b>
<b>10. Incoming Inspection Standards.....</b>	<b>20</b>
10.1. Inspection and Environment Conditions	20

**1. General Description and Features**

This TFT is a 7.0" color TFT-LCD (Thin Film Transistor Liquid Crystal Display) module composed of LCD panel, driver ICs, control circuit, projected capacitive touch panel and LED backlight. By applying 1024×600 images are displayed on the 7.0" diagonal screen. Display 16.7M colors by R.G.B signal input.

**1.1. Features**

- 1024 x RGB x 600 Pixels Resolution.
- Display in 16.7M Colors.
- Projected Capacitive Touch Panel
- RoHS Compliance

**1.2. LCD Module**

Item	Specification	Unit
Screen Size	7.0 Inches	Diagonal
Display Resolution	1024 x RGB x 600	Dot
Active Area	154.21 x 85.92	mm
Outline Dimension	170.00 x 110.00 x 9.00	mm
Display Mode	Normally White	--
Pixel Arrangement	RGB-Vertical Stripe	--
Pixel Size	0.1506 × 0.1432	mm
Surface Treatment	Anti-Glare	--
Display Color	16.7 Million	--
Viewing Direction	6 o'clock (Gray Inversion)	--
Input Interface	LVDS	--

**2. Mechanical Information**

Item		Min.	Typ.	Max.	Unit	Note
Module Size	Horizontal (H)	169.70	170.00	170.30	mm	--
	Vertical (V)	109.70	110.00	110.30	mm	
	Thickness (T)	8.70	9.00	9.30	mm	(1)
Weight		--	TBD	--	g	--

Note (1) Not include Component.

Refer to the Outline Dimension for further information.

**3. Electrical Specifications**

**3.1 Absolute Max. Ratings**

3.1.1 Absolute Ratings of Environment

If the operating condition exceeds the following absolute maximum ratings, the TFT LCD module may be damaged permanently.

(Ta=25±2°C, Vss=GND=0)

Item	Symbol	Min.	Max.	Unit	Note
Storage Temperature	T <sub>STG</sub>	-30	80	°C	(1)
Operating Temperature	T <sub>OPR</sub>	-20	70	°C	(1,2,3)

Note (1) 95 % RH Max. (40°C ≥ Ta). Maximum wet-bulb temperature at 39°C or less. (Ta > 40°C) No condensation.

Note (2) In case of below 0°C, the response time of liquid crystal (LC) becomes slower and the color of panel becomes darker than normal one. Level of retardation depends on temperature, because of LC's character

Note (3) Only operation is guaranteed at operating temperature. Contrast, response time, another display quality are evaluated at +25°C.

**3.2 Electrical Absolute Rating**

The following are maximum values which, if exceeded, may cause faulty operation or damage to the unit.

(Vss=GND=0)

Item	Symbol	Min.	Max.	Unit	Note
Digital Supply Voltage	DVDD DVDD_LVDS	-0.3	3.96	V	
Analog Supply Voltage	AVDD	-0.5	14.85	V	
Gate On Voltage	VGH	-0.3	40	V	
Gate Off Voltage	VGL	-20	0.3	V	
Gate On-Gate Off Voltage	VGH-VGL	12	40	V	
Signal Input Voltage	NIND0 ~ NIND3 PIND0 ~ PIND3 NINC,PINC	-0.5	5	V	
Forward Current(Per LED)	If	-	70	mA	
Reverse Voltage(Per LED)	VR	-	5	V	

**4. Electrical Characteristics**

**4.1. TFT-LCD Module**

4.1.1. Typical Operation Conditions

ITEM	SYMBOL	MIN	TYP	MAX	UNIT	NOTE
Digital Power Supply Voltage For LCD	DVDD	3	3.3	3.6	V	
Logic Input Voltage (LVDS:IN+,IN-)	VCM	$\frac{ VID }{2}$	-	$2.4 - \frac{ VID }{2}$	V	Note1
	VID	200	-	600	mV	Note1
	VTH	-	-	100	mV	VCM=1.2V Note1
	VTL	-100	-	-	mV	
Analog Power Supply Voltage	AVDD	9.4	9.6	9.8	V	
Gate On Power Supply Voltage	VGH	17	18	19	V	
Gate Off Power Supply Voltage	VGL	-6.6	-6	-5.4	V	
Common Power Supply Voltage	VCOM	3.7	3.9	4.1	V	Note2
Logic Input Voltage	VIH	0.7*DVDD	-	DVDD	V	
	VIL	GND	-	0.3*DVDD	V	

【Note1】 LVDS signal

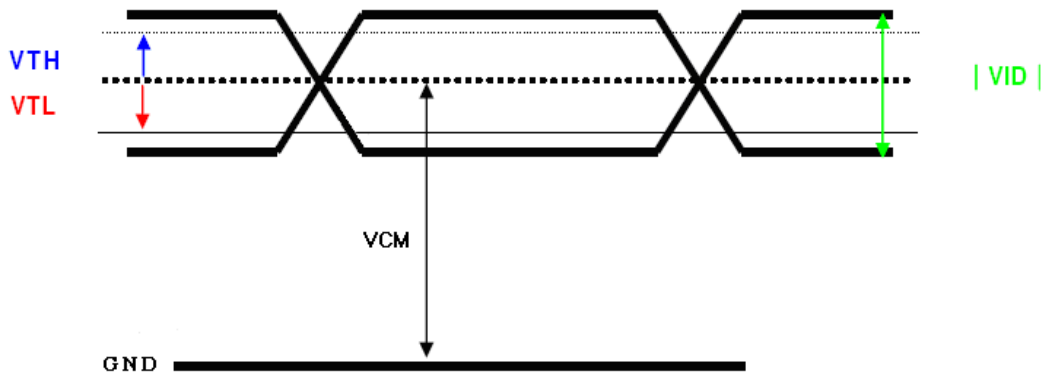

【Note2】 Please adjust VCOM to make the flicker level be minimum.

4.1.2. Current Consumption

ITEM	SYMBOL	CONDITION	MIN	TYPE	MAX	UNIT	NOTE
Gate On Power Current	IVGH	VGH =18V	--	0.5	1	mA	Note1
Gate Off Power Current	IVGL	VGL= -6V	--	0.5	1	mA	Note1
Digital Power Current	IDVDD	DVDD = 3.3V	--	30	45	mA	Note1
Analog Power Current	IAVDD	AVDD = 9.6V	--	35	45	mA	Note1
Total Power Consumption	PC		--	447	604	mW	Note1

【Note1】 Typ. specification : Gray-level test Pattern

Max. specification : Black test Pattern

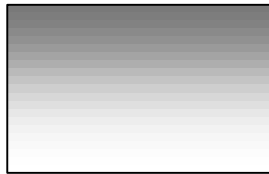

256 gray pattern



Black Pattern

4.1.3. Power - Signal Sequence

Power On : DVDD→AVDD/VGL →VGH →Video & Logic Signal→Backlight

Power Off : Backlight→Video & Logic Signal→ VGH→AVDD/VGL→DVDD

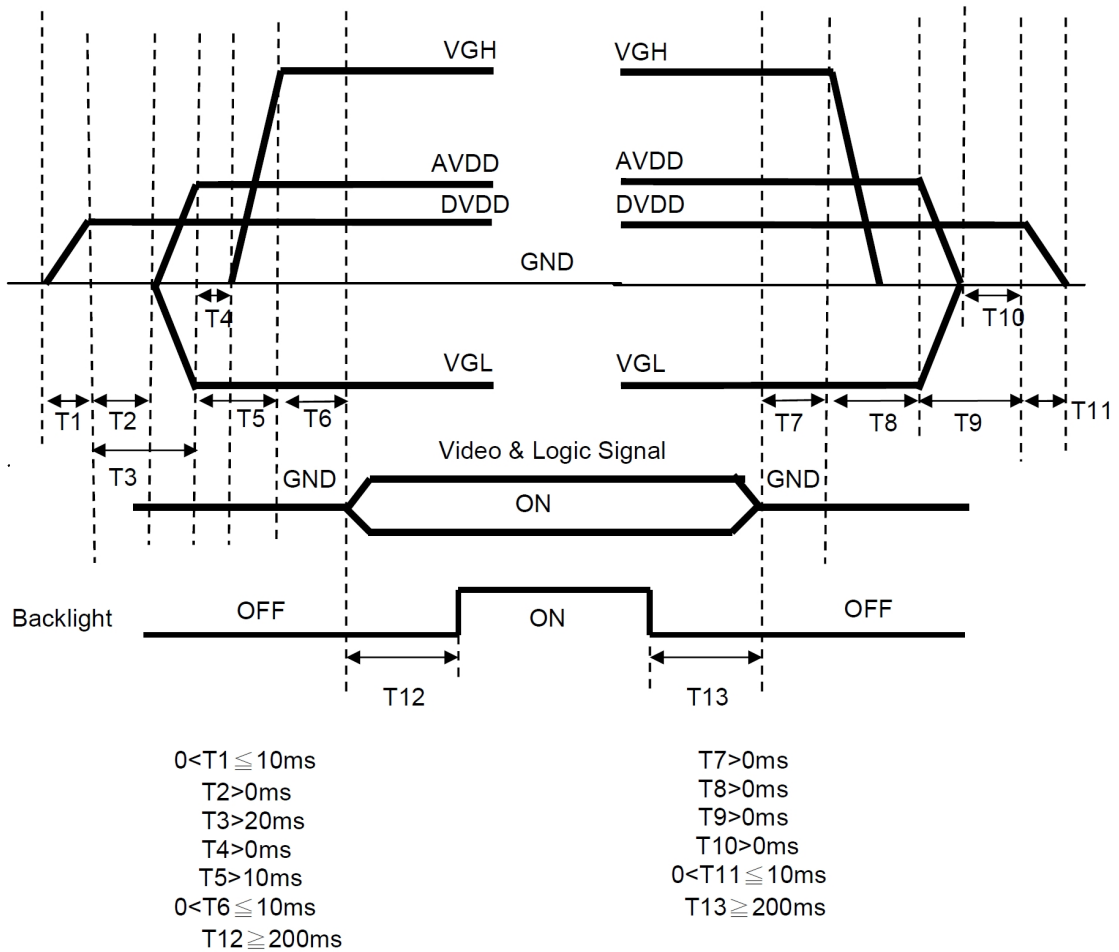

4.1.4. Timing Characteristics of Input Signals

ITEM		SYMBOL	MIN	TYP	MAX	UNIT	
LVDS Input Signal Sequence	CLK Frequency	tclk	45	51.2	57	MHz	
LCD Input Signal Sequence (Input LVDS Transmitter)	Horizontal	Horizontal total Time	tH	1324	1344	1364	tCLK
		Horizontal effective Time	tHA	1024			tCLK
		Horizontal Blank Time	tHB	300	320	340	tCLK
	Vertical	Vertical total Time	tV	625	635	645	tH
		Vertical effective Time	tVA	600			tH
		Vertical Blank Time	tVB	25	35	45	tH



4.1.5. Timing Sequence(Timing Chart)

Horizontal Timing Sequence

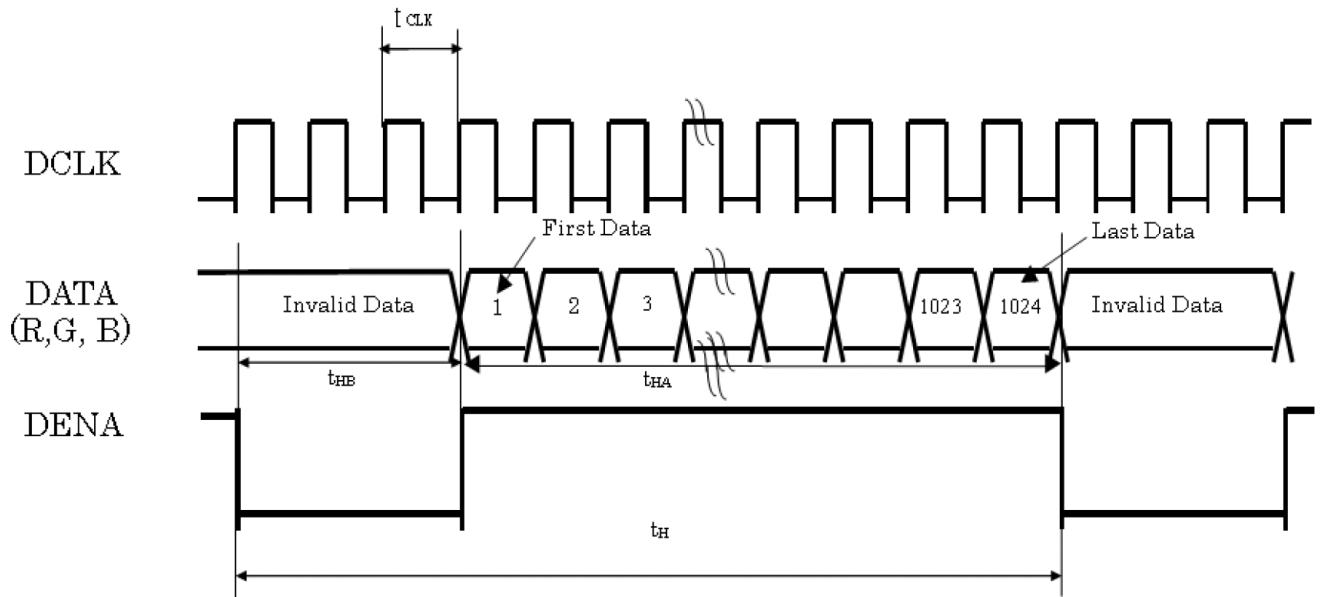

Vertical Timing Sequence

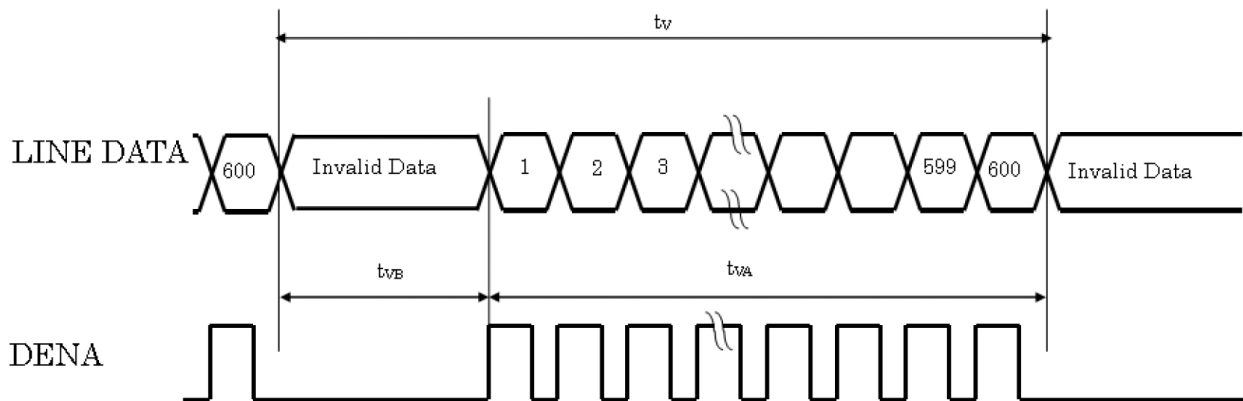

4.1.6. LVDS Input Data Mapping

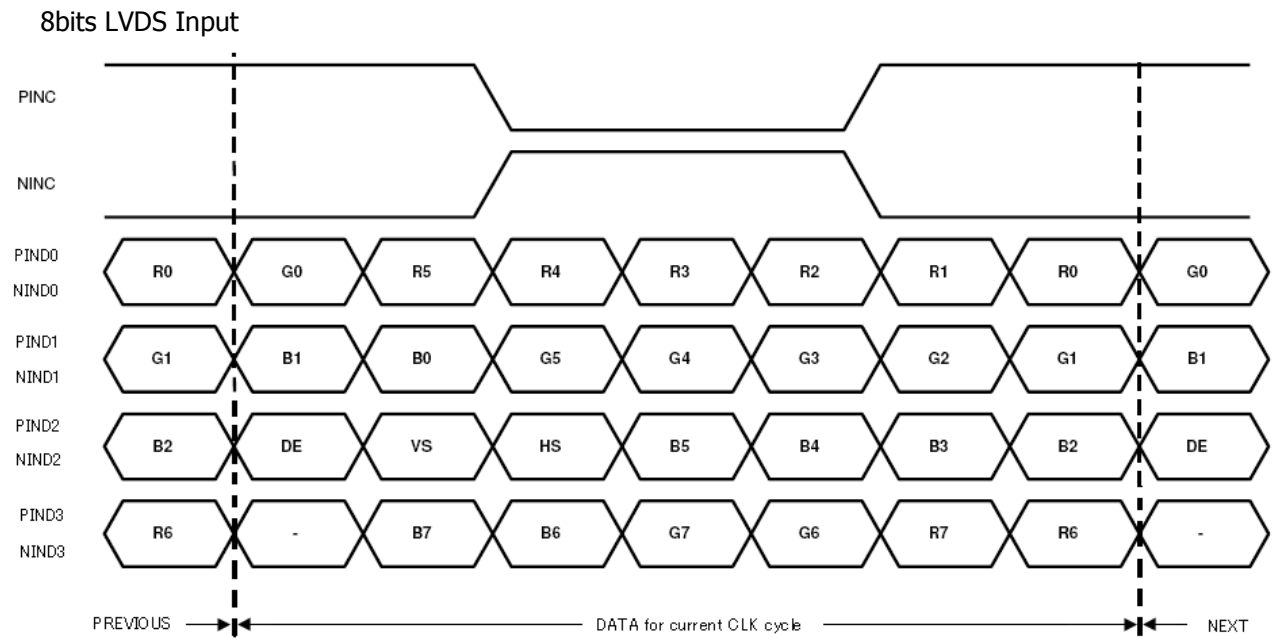
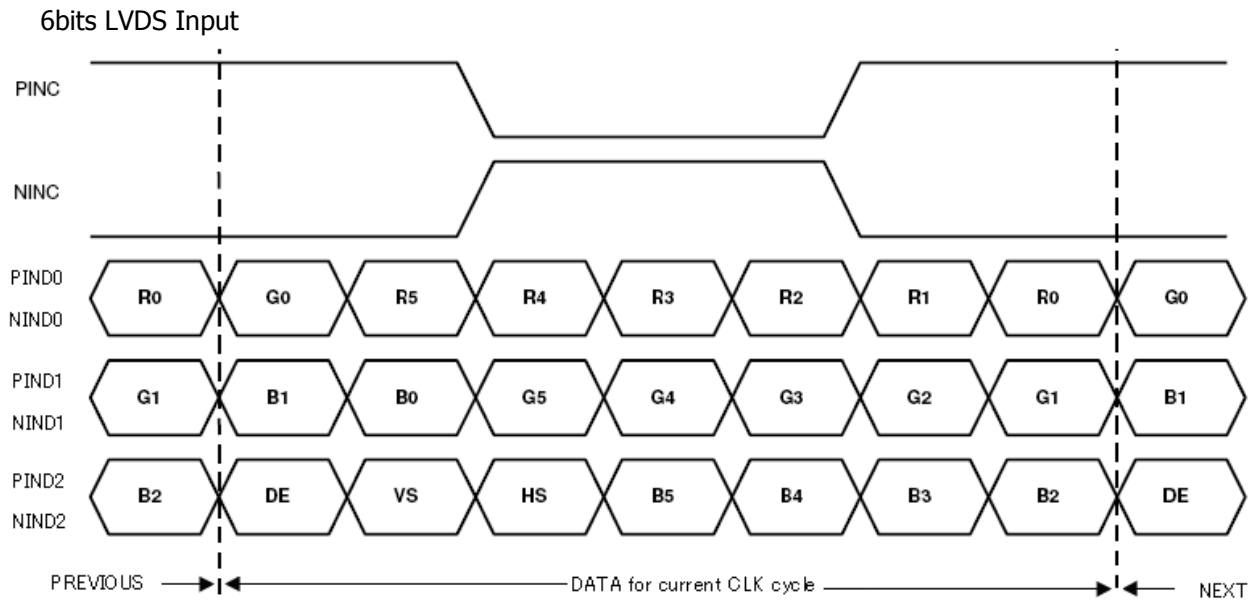

## 4.2. Backlight Unit

(Ta=25±2°C)

Item	Symbol	Value			Unit	Note
		Min.	Typ.	Max.		
LED Total Input Voltage	VL	8.4	9.0	10.2	V	
LED Total Input Current	IL	-	630	-	mA	(1)
Power Consumption	P <sub>BL</sub>	-	5.67	6.43	W	(2)
Lifetime	-	50,000	-	-	Hrs	(3)

Note (1) LEDs in 3 series x 14 parallel type.

(2) Where  $IL = 630\text{mA}$ ,  $VL = 9$ ,  $P_{BL} = VB \times IB$ (3) The environmental conducted under ambient air flow, at  $Ta=25\pm 2^\circ\text{C}$ ,  $60\%RH\pm 5\%$

## 5. Input Terminal Pin Assignment

## 5.1. Pin Assignment (LCD)

Pin No.	Symbol	Function	Remark
1	VCOM	Common Voltage	
2	DVDD	Digital Power	
3	DVDD	Digital Power	
4	NC	Not Connect	
5	RESET	Global reset pin. Active low to enter reset state. Suggest to connecting with an RC reset circuit for stability. Normally pull high. (R=10K $\Omega$ , C=0.1 $\mu$ F)	
6	STBYB	Standby mode, normally pull high STBYB="1", normal operation STBYB="0", timing control, source driver will turn off, all output are high-Z	
7	GND	Ground	
8	NIND0	Negative LVDS differential data input	
9	PIND0	Positive LVDS differential data input	
10	GND	Ground	
11	NIND1	Negative LVDS differential data input	
12	PIND1	Positive LVDS differential data input	
13	GND	Ground	
14	NIND2	Negative LVDS differential data input	
15	PIND2	Positive LVDS differential data input	
16	GND	Ground	
17	NINC	Negative LVDS differential clock input	
18	PINC	Positive LVDS differential clock input	
19	GND	Ground	
20	NIND3	Negative LVDS differential data input	
21	PIND3	Positive LVDS differential data input	
22	GND	Ground	
23	NC	Not Connect	
24	NC	Not Connect	
25	GND	Ground	
26	NC	Not Connect	
27	NC	Not Connect	
28	SELB	6bit/8bit Mode Select	*1)
29	AVDD	Power for Analog Circuit	
30	GND	Ground	
31	NC	Not Connect	

32	NC	Not Connect	
33	SHLR	Horizontal Inversion	*2)
34	UPDN	Vertical Inversion	*2)
35	VGL	Negative Power for TFT	
36	NC	Not Connect	
37	NC	Not Connect	
38	VGH	Positive Power for TFT	
39	NC	Not Connect	
40	NC	Not Connect	

Remarks :

\*1) if LVDS input data is 6bits , SELB must must be set to High  
 if LVDS input data is 8bit , SELB must be set to Low

\*2) UPDN and SHLR control function

UPDN	SHLR	FUNCTION
0	1	Normal Display
0	0	Inverse Left and Right
1	1	Inverse Up and Down
1	0	Inverse Left and Right Inverse Up and Down

SHLR	UPDN	Data shifting
DVDD	GND	Left→Right , Up→Down(default)
GND	GND	Right→Left , Up→Down
DVDD	DVDD	Left→Right , Down→Up
GND	DVDD	Right→Left , Down→Up

Definition of scanning direction.

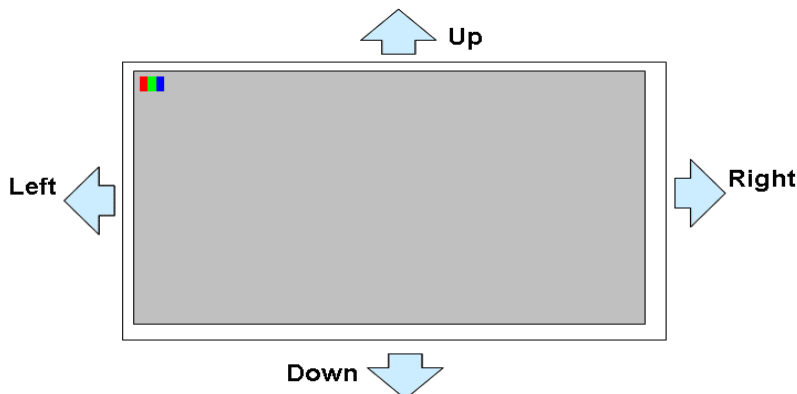

**5.2. Pin Assignment (Backlight unit)**

Pin No.	Symbol	Function	Remark
1	A	Power for LED backlight anode	Red
2	K	Power for LED backlight cathode	Black

**6. Optical Characteristics**

Item	Symbol	Condition	Min	Type	Max	Unit	Note	
Brightness	B		1080	1200	--	cd/m <sup>2</sup>		
Response Time (White - Black)	Tr +Tf	$\theta=0^\circ$	--	25	40	ms		
Contrast Ratio	CR	At optimized viewing angle	600	800	--	--		
Luminance Uniformity	$\Delta L$		75	80		%		
Color Chromaticity (CIE 1931)	White	Wx	$\theta=0^\circ$ Normal Viewing Angle	0.273	0.313	0.353	--	BM-7A
		Wy		0.289	0.329	0.369		
Viewing Angle (6H)	Hor.	$\theta_R$	CR $\geq$ 10	60	70	--	Degree	
		$\theta_L$		50	60	--		
	Ver.	$\theta_U$		70	80	--		
		$\theta_D$		70	80	--		

a. Test equipment setup

After stabilizing and leaving the panel alone shall be warmed up for the stable operation of LCM, the measurement should be executed. Measurement should be executed in a stable, windless, and dark room. Optical specifications are measured by Topcon BM-7(fast) with a viewing angle of 2° at a distance of 50cm and normal direction.

b. Definition of response time: Tr and Tf

The response time is defined as the following figure and shall be measured by switching the input signal for "black" and "white".

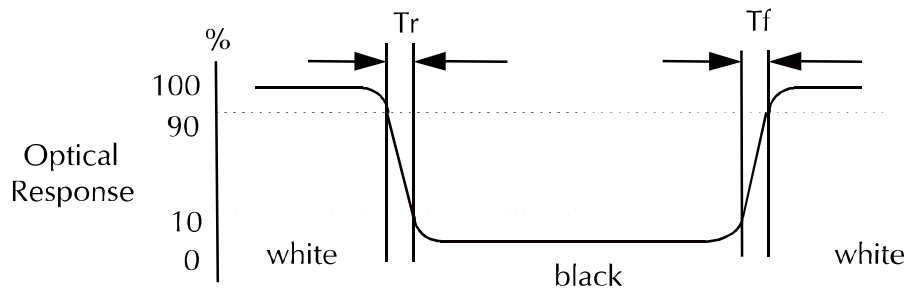

c. Definition of contrast ratio:

$$\text{Contrast Ratio (CR)} = \frac{\text{Brightness measured when LCD is at "white state"}}{\text{Brightness measured when LCD is at "black state"}}$$

d. Measured at the center area of the panel when all the input terminals of LCD panel are electrically opened.

e. View Angle

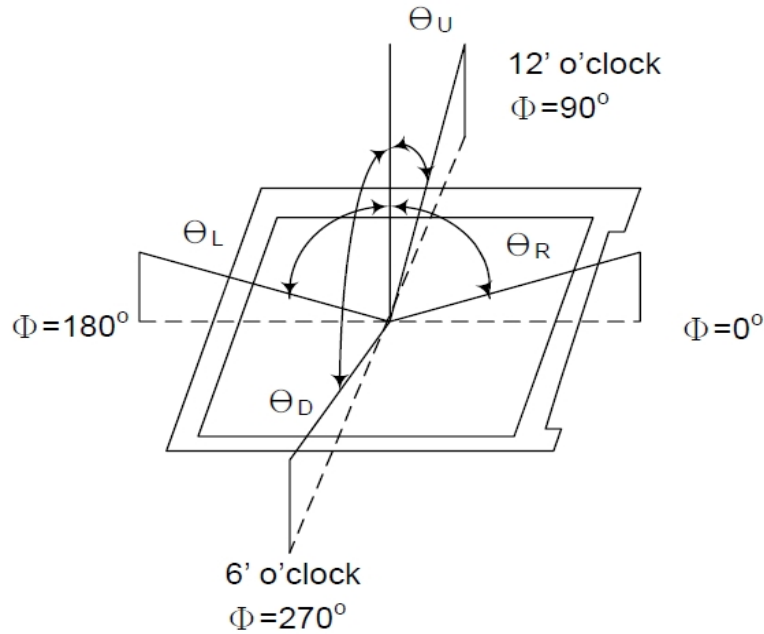

f. Definition of Luminance of White: Luminance of white at the center points

Light Source of Back-Light Unit	LED Type
---------------------------------	----------

g. Definition of White Uniformity

$$\text{White Uniformity} = \frac{\text{Min. luminance of white among 9-points}}{\text{Max. luminance of white among 9-points}} \times 100\%$$

h. The definition of Color Gamut -Color Chromaticity CIE 1931

Color coordinate of white & red, green, blue at center point.

Color Gamut : NTSC(%) = ( RGB Triangle Area / NTSC Triangle Area ) x 100

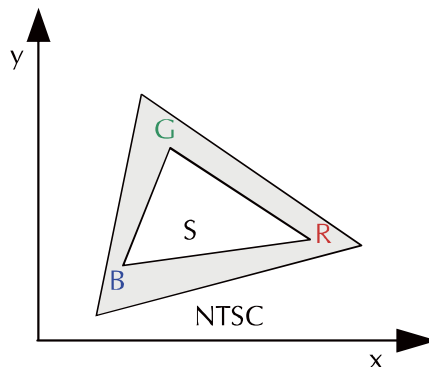

**7. Projected capacitive touch Screen Panel Specifications****7.1. Touch Panel**

Item	Specification	Unit
Screen Size	7.0 Inches	Diagonal
Type	Transparent Type Projected Capacitive Touch Panel	--
Input Mode	Human's Finger	--
Sensor Active Area	156.21 (W) x 87.92 (H)	mm
Interface	I2C	--
Cover Glass Pencil-Hardness	6H(min) by JIS K5400	--
IC Solution	IC : ILI2116	--

**7.2. DC Characteristics**

Item	Symbol	Min.	Typ.	Max.	Unit	Remark
Power supply Logic Voltage	VDD	2.8	3.3	3.6	V	
Charge pump power supply voltage	VDD3	2.8	3.3	3.6	V	
Input high voltage	V <sub>IH</sub>	0.7*VDDIO	-	VDDIO	V	Note.1
Input low voltage	V <sub>IL</sub>	-0.3	-	0.3*VDDIO	V	
Output high voltage	V <sub>OH</sub>	-	VDDIO	-	V	
Output low voltage	V <sub>OL</sub>	-	0.3	-		
Input leakage current	I <sub>I</sub>	-	1	-	μA	
I <sup>2</sup> C Pull-high/low impedance	R <sub>IN</sub>	-	4.7K	-	Ω	SDA/SCL Note.2
Operation mode current	I <sub>OP</sub>	-	TBD	-	mA	Note.3
Standby current	I <sub>Idle</sub>	-	TBD	-	mA	Note.3
Sleeping current	I <sub>Sleep</sub>	-	20	-	μA	

Note 1: The interface power voltage level (VDDIO= 1.8V or 3.3V) is detected by ILI2116 automatically and the voltage level is determined by RSTN pin.

Note 2: SCL and SDA pins have internal pull high 4.7K ohm resistor.

Note 3: The power consumption depends on sensor loading condition.

**7.3. Pin Assignments and Definitions.**

Item	Name	I/O	Unit
1	VDD	P	Power supply 3.3V
2	GND	P	Ground
3	GND	P	Ground
4	SCL	I	I2C Clock
5	SDA	I/O	I2C Data
6	GND	P	Ground
7	INT	I	Interrupt request to the host
8	RST	I	External Reset, active low



**7.4. FUNCTIONAL DESCRIPTION**

7.4.1. AC Characteristics of the SDA and SCL on I<sup>2</sup>C interface

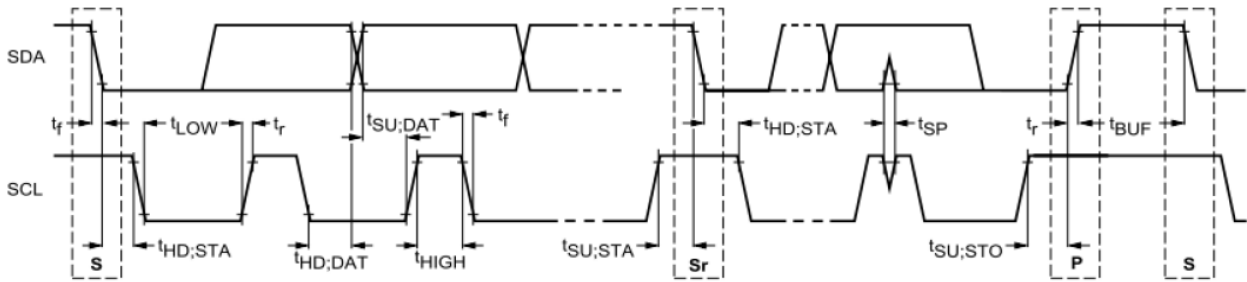

7.4.2. Characteristics of the SDA and SCL bus lines

Symbol	Parameter	100KHz			400KHz		
		Min	Max	Unit	Min	Max	Unit
$f_{SCL}$	SCL clock frequency	0	100	kHz	0	400	KHz
$t_{HD:STA}$	Hold time (repeated) START condition. After this period, the first clock pulse is generated	4.0	-	$\mu$ s	0.6	-	$\mu$ s
$t_{LOW}$	LOW period of the SCL clock	4.7	-	$\mu$ s	1.3	-	$\mu$ s
$t_{HIGH}$	HIGH period of the SCL clock	4.0	-	$\mu$ s	0.6	-	$\mu$ s
$t_{SU:STA}$	Set-up time for a repeated START condition	4.7	-	$\mu$ s	0.6	-	$\mu$ s
$t_{HD:DAT}$	Data hold time	5.0	-	$\mu$ s	-	-	$\mu$ s
	For I <sup>2</sup> C Device	0	3.45	$\mu$ s	0	0.9	$\mu$ s
$t_{SU:DAT}$	Data set-up time	250	-	ns	100	-	ns
$t_r$	Rise time of both SDA and SCL signals	-	1000	ns	-	300	ns
$t_f$	Fall time of both SDA and SCL signals	-	300	ns	-	300	ns
$t_{SU:STO}$	Set-up time for STOP condition	4.0	-	$\mu$ s	0.6	-	$\mu$ s
$t_{BUF}$	Bus free time between a STOP and START condition	4.7	-	$\mu$ s	1.3	-	$\mu$ s

**8. Reliability Condition**

No change on display and in operation under the following test condition.

Condition: Unless otherwise specified, tests will be conducted under the following condition.

Temperature: 20±5°C.

Humidity: 65±5%RH.

Tests will be not conducted under functioning state.

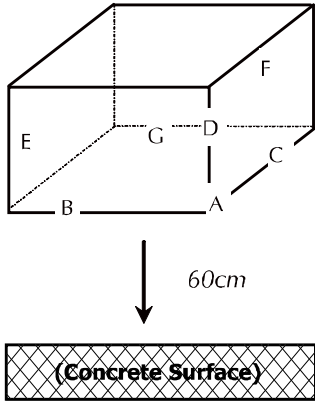
No.	Parameter	Condition	Notes
1	High Temperature Operating	70°C±2°C, 240hrs (Operation state).	
2	Low Temperature Operating	-20°C±2°C, 240hrs (Operation state).	1
3	High Temperature Storage	80°C±2°C, 240hrs.	2
4	Low Temperature Storage	-30°C±2°C, 240hrs.	1,2
5	High Temperature and High Humidity Operation Test	60°C±2°C, 90%, 240hrs.	1,2
6	Vibration Test	Total fixed amplitude: 1.5mm. Vibration Frequency: 10~55Hz. One cycle 60 seconds to 3 direction of X, Y, Z each 15 minutes.	3
7.	Drop Test	To be measured after dropping from 60cm high on the concrete surface in packing state.  <i>Dropping method corner dropping:</i> <i>A corner: Once edge dropping.</i> <i>B, C, D edge: Once face dropping.</i> <i>E, F, G face: Once.</i>	

- Notes:
1. No dew condensation to be observed.
  2. The function test shall be conducted after 4 hours storage at the normal temperature and humidity after removed from the test chamber.
  3. Vibration test will be conducted to the product itself without putting I in a container.

10. DIMENSIONAL OUTLINE

PIN FUNCTION		PIN	SYMBOL
1	VCOM	21	PIND3
2	DVDD	22	GND
3	DVDD	23	NC
4	NC	24	NC
5	RESET	25	GND
6	STBYB	26	NC
7	GND	27	NC
8	NIND0	28	SELB
9	PIND0	29	AVDD
10	GND	30	GND
11	NIND1	31	NC
12	PIND1	32	NC
13	GND	33	SHLR
14	NIND2	34	UPDN
15	PIND2	35	VGL
16	GND	36	NC
17	NINC	37	NC
18	PINC	38	VGH
19	GND	39	NC
20	NIND3	40	NC

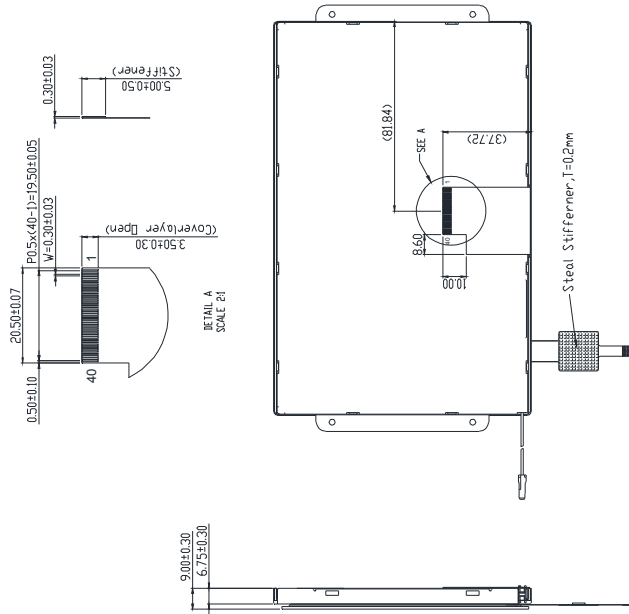

PIN	FUNCTION(P)	SYMBOL
1	VDD	
2	GND	
3	GND	
4	SCL	
5	SDA	
6	GND	
7	INT	
8	RESET	

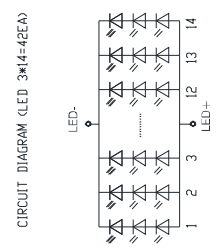
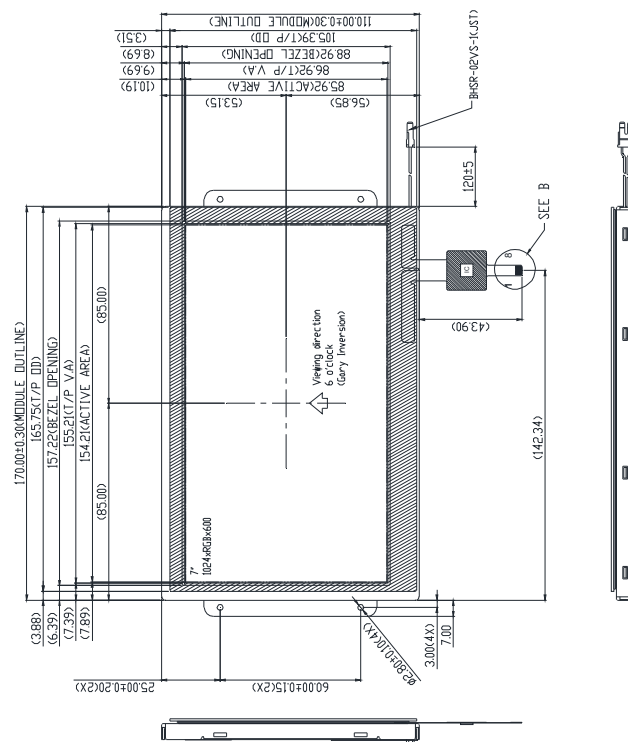
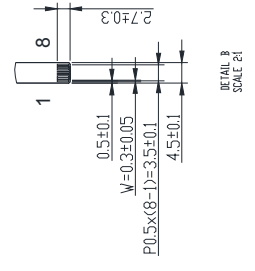

Specification	
Display type	7" TFT-TN
Resolution	1024xRGBx600
Display mode	Normally White
Viewing Direction	6 o'clock (Gray inversion)
Viewing Angle(U/D/L/R)	70/60/80/80
Brightness(Center point)	1200cd/m <sup>2</sup> Typ.
Color Chromaticity	x=0.313±0.05, y=0.329±0.05
NTSC	50%
Backlight	LED 42pcs, 3S14P 630mA
Operating Temperature	-20~+70°C
Storage Temperature	-30~+80°C

**10. Incoming Inspection Standards**

**10.1. Inspection and Environment Conditions**

10.1.1. Inspection Conditions:

- (1) Inspection Distance: 35 cm±5cm
- (2) View Angle : Light-on Inspection Angle : ±5°

Cosmetic Inspection Angle : ±45°

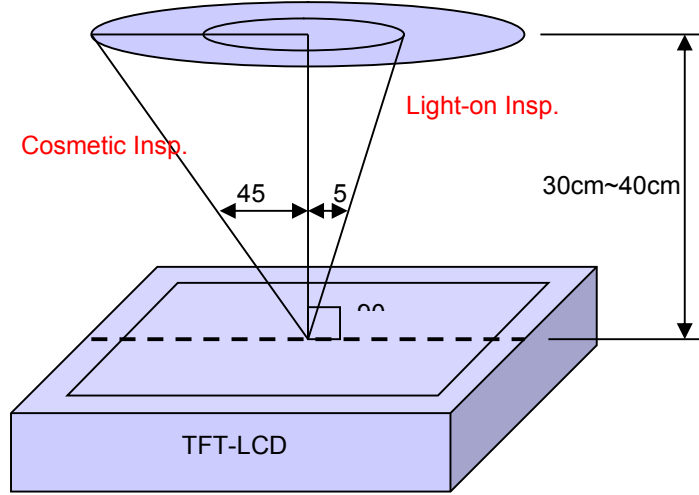

( perpendicular to LCD panel surface)

10.1.2. Environment Conditions:

Ambient Temperature		23°C ±5°C
Ambient Humidity		55±10%RH
Ambient Illumination	Cosmetic Inspection	more than 600 Lux
	Functional Inspection	300~500 Lux

10.1.3. Sampling Conditions:

- (1) Lot Size: Quantity of shipment lot per model
- (2) Sampling Method:

Sampling Plan		MIL-STD-105E
		Normal Inspection, Single Sampling
		Level II
AQL	Major Defect	1.0%
	Minor Defect	1.5%

- (3) The classification of Major(MA) and Minor(MI) defects is shown as 3. Inspection Criteria.

10.1.4. Inspection Criteria

10.1.4.1. Cosmetic Inspection(Panel):

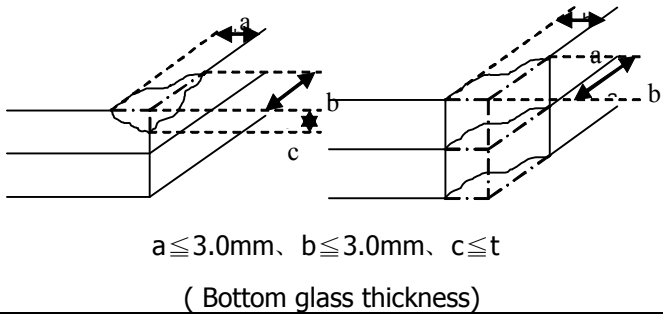
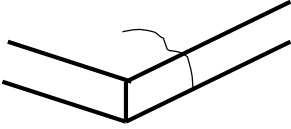
Item	Judgment Criteria	Classification
Chipping on Panel	 <p><math>a \leq 3.0\text{mm}</math>, <math>b \leq 3.0\text{mm}</math>, <math>c \leq t</math> ( Bottom glass thickness)</p>	MA
Scratch on Panel *Note-2	<p><math>W \leq 0.05\text{mm}</math> or <math>L &lt; 5\text{mm}</math>: Ignored</p> <p><math>0.05\text{mm} &lt; W \leq 0.1\text{mm}</math> and <math>L \leq 5\text{mm}</math>: <math>N \leq 5</math></p> <p><math>W &gt; 0.1\text{mm}</math> or <math>L &gt; 5\text{mm}</math>: Not allowed</p>	MI
Bubble or Dent on Panel *Note-3	<p><math>D \leq 0.2\text{mm}</math>: Ignored</p> <p><math>0.2\text{mm} &lt; D \leq 0.3\text{mm}</math>: <math>N \leq 5</math></p> <p><math>D &gt; 0.3\text{mm}</math>: Not allowed</p>	MI
Panel Crack	 <p>Not Allowed crack</p>	MA
Bezel Deformation	Obvious deformation is not allowed.	MI
Bezel Oxidation	Not allowed if it rusts continuously over 1 cm (It is out of warranty with rusted tin plate)	MI
Bezel Scratch	$L \leq 20\text{mm}$ , $W \leq 0.2$ , $N \leq 3$	MI
Metal Squash Dent /Flange(Front Side)	$D(W) \leq 1, L \leq 3, N \leq 3$ ;	MI
B/L High Voltage Wire Denudation	Not allowed	MA
Polarizer flaw or leak out resin	Defect is defined as the active area.	MI
Outline Dimension	Must in Spec, refer to related product spec.	MI

10.1.4.2. Functional Inspection:

Item	Judgment Criteria			Classification
	Area(Note1)	I	O	
Point Defect	Bright dot	Random	2	
		2 dots adjacent	0	0
		3 dots adjacent or more	0	0
	Dark dot	Random	3	
		2 dots adjacent	1	
		3 dots adjacent or more	0	0
	Total Dot Defect		5	
	Distance	Distance between Bright and Bright dot	$L \geq 5\text{mm}$	
		Distance between Bright and Dark dot	$L \geq 5\text{mm}$	
		Distance between Dark dot	$L \geq 5\text{mm}$	
	(1) It is defined as Point Defect if defect area > 0.5dot (2) It is ignored if defect area $\leq 0.5\text{dot}$ (3) Weak point defect will be defined as Bright Dot if it can be observed through ND filter 5%( Full Screen Black Inspection)			
Line Defect	Obvious vertical or horizontal line defect is not allowed.			MA
Mura	Not allowed if it can be observed through ND Filter 5 %			MI
Foreign Material in spot shape *Note-3	$D \leq 0.2\text{mm}$ : Ignored $0.2\text{mm} < D \leq 0.5\text{mm}$ : $N \leq 8$ $D > 0.5\text{mm}$ : Not allowed			MI
Foreign Material in line or spiral shape *Note-4	$W \leq 0.05\text{mm}$ or $L \leq 5\text{mm}$ : Ignored $0.05\text{mm} < W \leq 0.2\text{mm}$ and $L 1.0\text{mm} \leq 5\text{mm}$ : $N \leq 8$ $W > 0.2\text{mm}$ or $L > 5\text{mm}$ : Not allowed			MI
Display Function Abnormal	No Malfunction can be allowed			MA

Note-1 : I/O Area Definition

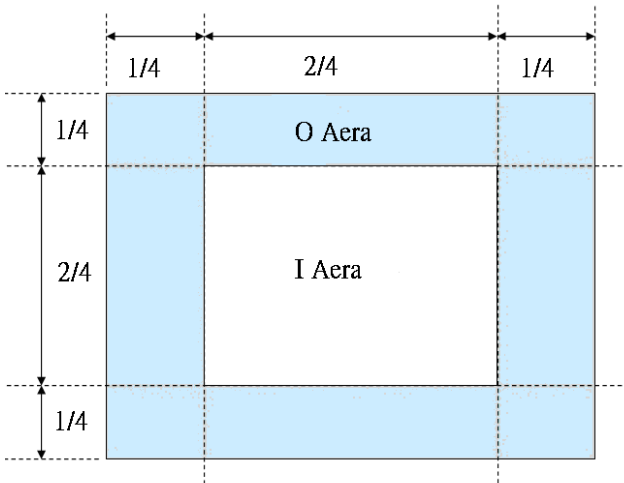

Note-2 : Polarizer Scratch

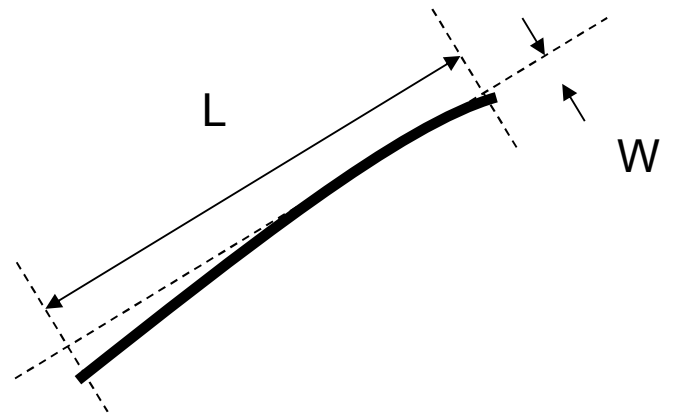

Note-3 : Spot Foreign Material  
( $W \geq L / 4$ )

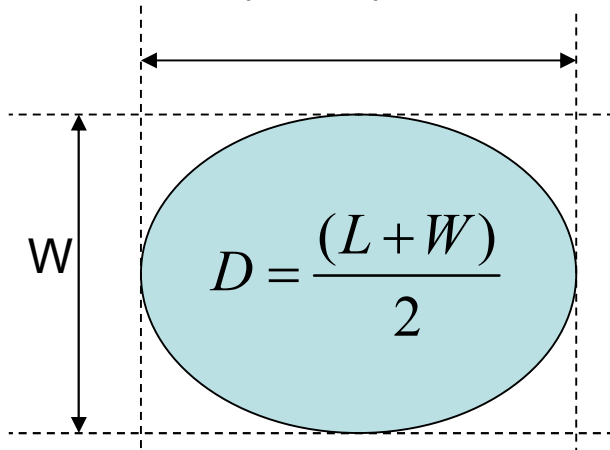

Note-4 : Line or Spiral Foreign Material  
( $W < L / 4$ )

