

Opto Plus LED Corp.
0.56" SMD Type LED Display
OPS-S5620B-GW
OPS-S5621B-GW

● **EDIT HISTORY**

Version A: Jan. 08, 2013

Preliminary spec.

Version B: Mar. 05, 2015

Add package spec.

Manufacture	Examination	Approving

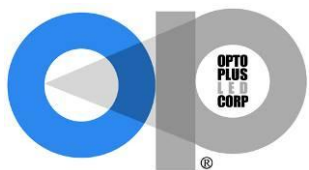

Opto Plus LED Corp.
0.56" SMD Type LED Display
OPS-S5620B-GW
OPS-S5621B-GW

● **FEATURES**

- 0.56 inch (14.20 mm) Digit Height.
- SMD type.
- Low current operation.
- Gray face, White segment.
- RoHS compliant, Pb Free.

● **DESCRIPTION**

The OPS-S5620B-GW & OPS-S5621B-GW are 0.56 inch (14.20mm) height Single digit 7-segment displays.

This device utilizes Super Bright Blue LED chip which are made from InGaN On a transparent GaN, substrate.

The display has Gray face, White segment.

● **DEVICE**

PART NO	DESCRIPTION
OPS-S5620B-GW	Common Anode
OPS-S5621B-GW	Common Cathode

RoHS Compliance



Pb free.



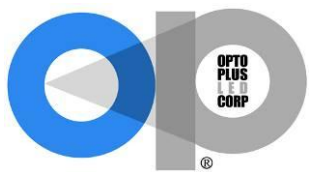

Opto Plus LED Corp.

0.56" SMD Type LED Display

OPS-S5620B-GW

OPS-S5621B-GW

● MECHANICAL DIMENSIONS

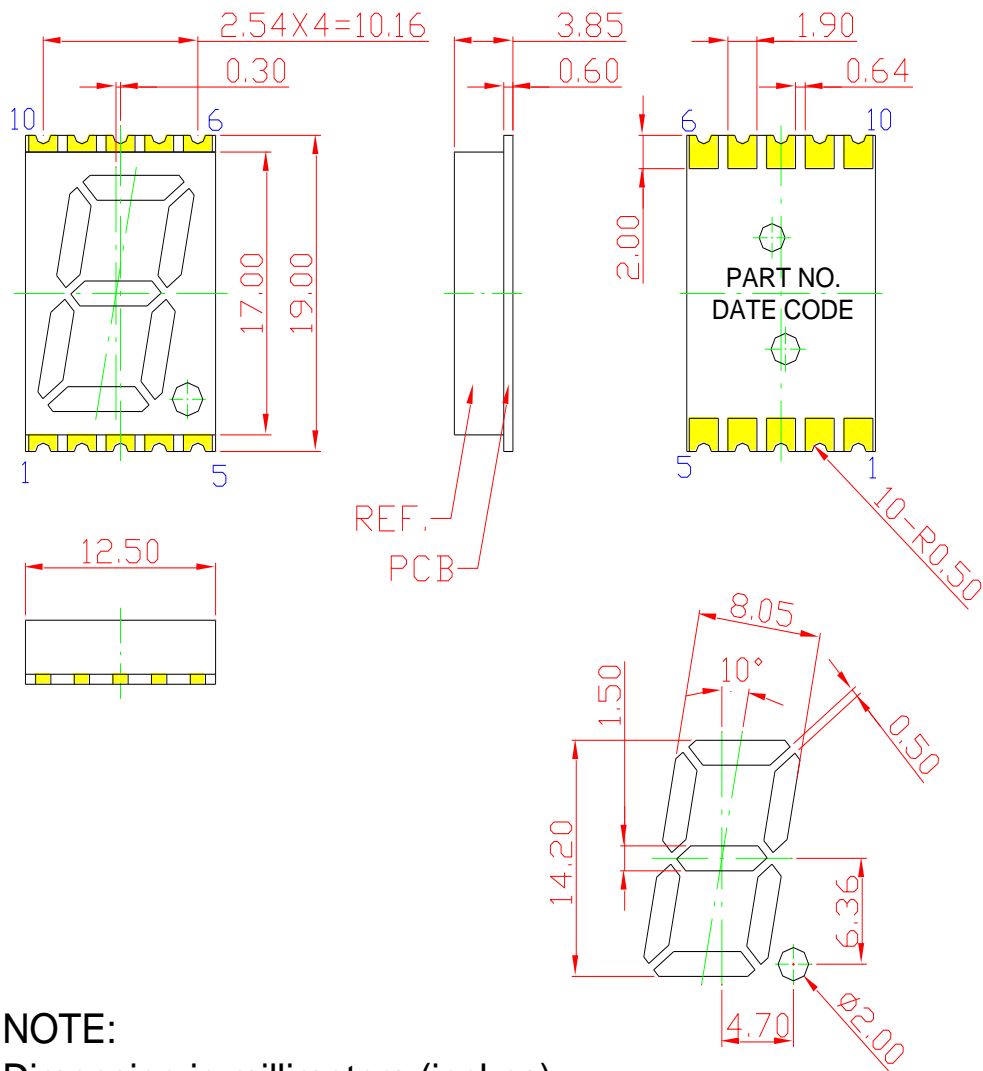

NOTE:

Dimension in millimeters (inches),
and tolerances are $\pm 0.25\text{mm}$ (.01") specified.

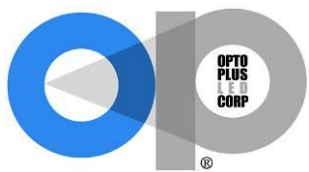

Opto Plus LED Corp.

0.56" SMD Type LED Display

OPS-S5620B-GW

OPS-S5621B-GW

● TYPICAL INTERNAL EQUIVALENT CIRCUIT

Recommended Soldering Pattern

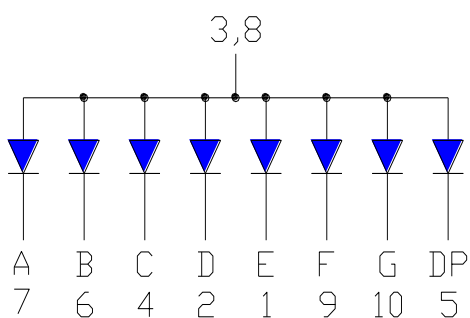
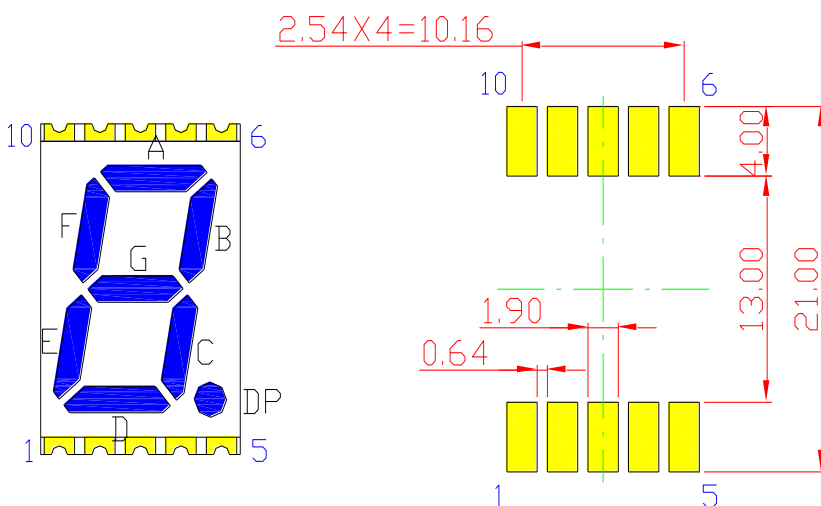

OPS-S5620B-GW
(Common Anode)

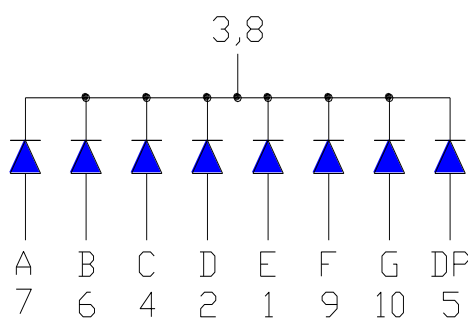

OPS-S5621B-GW
(Common Cathode)

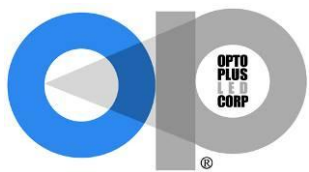

Opto Plus LED Corp.
0.56" SMD Type LED Display
OPS-S5620B-GW
OPS-S5621B-GW

● **B: SUPER BRIGHT BLUE (InGaN/GaN)**

ABSOLUTE MAXIMUM RATING AT $T_a=25^{\circ}\text{C}$

Parameter	Symbol	Maximum Rating	Unit
Power dissipation	P_{AD}	120	mW
Derating liner from 25°C	-	0.3	mA / $^{\circ}\text{C}$
Continuous forward current	I_{AF}	30	mA
Peak current (duty cycle 1/10, 1kHz)	I_{PF}	100	mA
Reverse voltage	V_R	5	V
Operating temperature	T_{OPR}	-40 to +105	$^{\circ}\text{C}$
Storage temperature	T_{STG}	-40 to +105	$^{\circ}\text{C}$

ELECTRICAL - OPTICAL CHARACTERISTICS AT $T_a=25^{\circ}\text{C}$

Characteristic	Symbol	Condition	Min.	Type.	Max.	Unit
Forward Voltage, (Per Dice)	V_F	$I_F=5\text{mA}$	-	3.0	3.5	V
Reverse Current, (Per Dice)	I_R	$V_R=8\text{V}$	-	-	10	μA
Dominant Wavelength	λ_D	$I_F=5\text{mA}$	460	465	470	nm
Luminous Intensity	I_V	$I_F=5\text{mA}$	-	8	-	mcd
Spectral radiation bandwidth	$\Delta\lambda$	$I_F=5\text{mA}$	-	30	-	nm

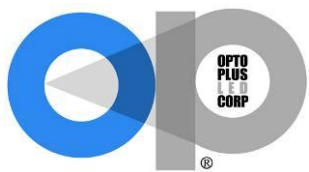

Opto Plus LED Corp.

0.56" SMD Type LED Display

OPS-S5620B-GW

OPS-S5621B-GW

● B: SUPER BRIGHT BLUE (InGaN/GaN) CURVE

Typical Electro-optical Characteristic Curves
(25 °C Free Air Temperature Unless Otherwise Specified)

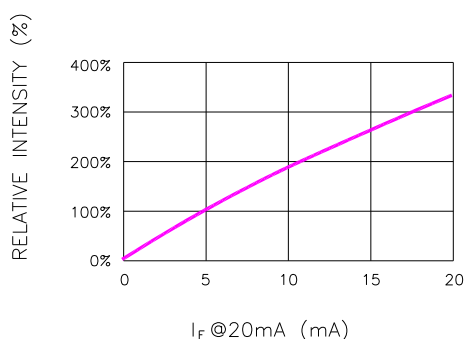

Fig.1 RELATIVE INTENSITY VS. FORWARD CURRENT

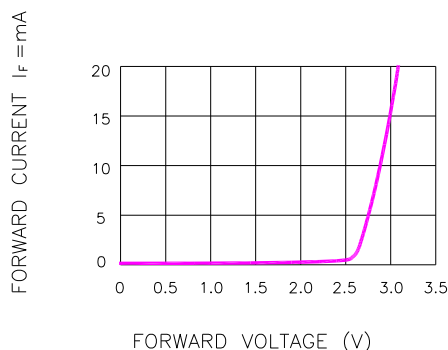

Fig.2 FORWARD CURRENT VS. FORWARD VOLTAGE

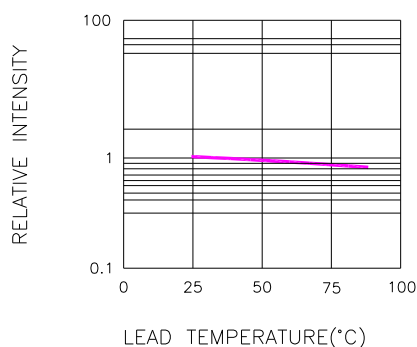

Fig.3 RELATIVE INTENSITY VS. LEAD TEMPERATURE
(PULSED 20 mA; 300us PULSE, 10ms PERIOD)

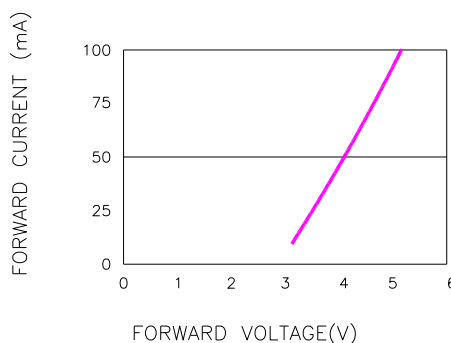

Fig.4 PEAK FORWARD VOLTAGE VS. FORWARD CURRENT
(100us TEST PULSE, 1% DUTY CYCLE)

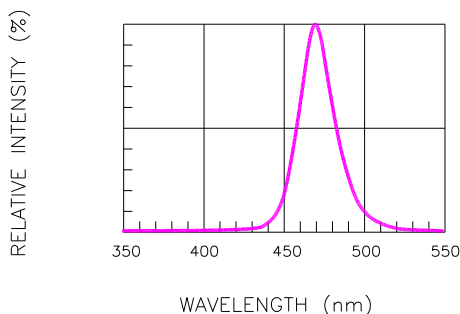

Fig.5 RELATIVE INTENSITY VS. WAVELENGTH

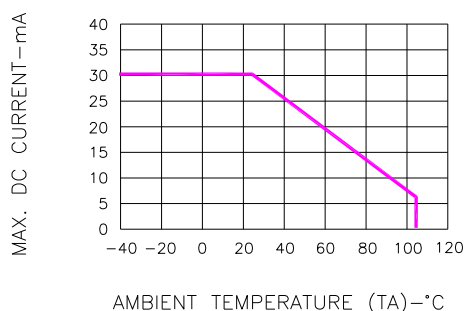
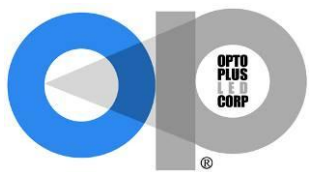

Fig.6 MAX. ALLOWABLE DC CURRENT VS. AMBIENT TEMPERATURE



Opto Plus LED Corp.
0.56" SMD Type LED Display
OPS-S5620B-GW
OPS-S5621B-GW

● **SMT REFLOW SOLDERING INSTRUCTIONS**

SMT Soldering Profile

Pb free reflow soldering Profile

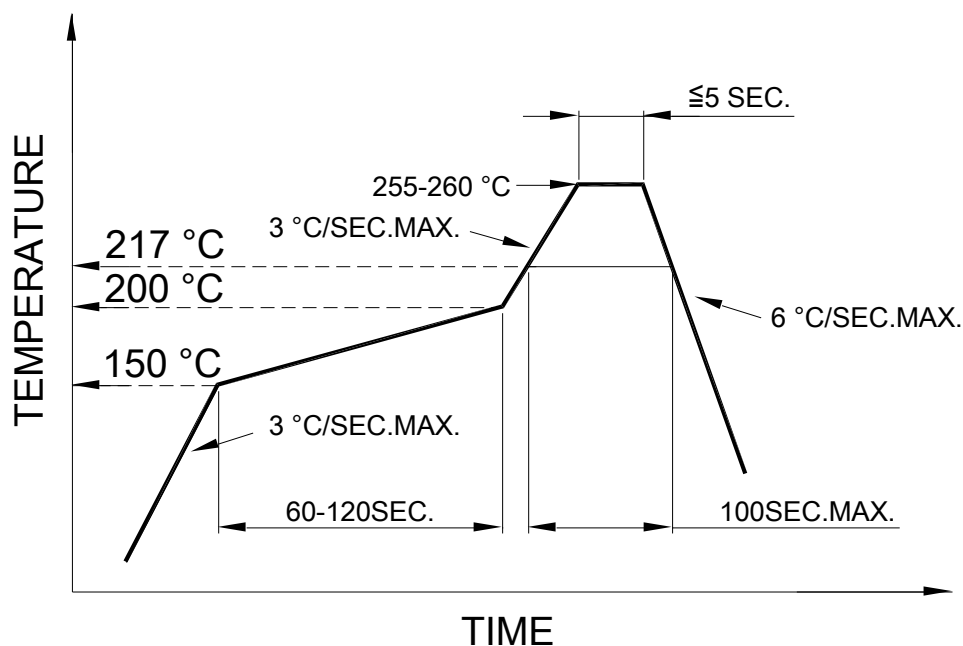

● **SOLDERING IRON**

Basic spec is ≤ 4 sec when 260°C. If temperature is higher, time should be shorter (+10°C→1 sec). Power dissipation of Iron should be smaller than 15W, and temperature should be controllable. Surface temperature of the device should be under 230°C.

● **REWORK**

- Customer must finish rework within 3 sec. under 350°C.
- The head of soldering iron cannot touch copper foil.

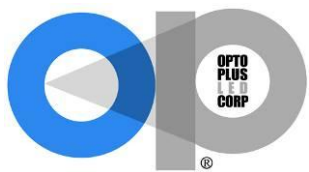

Opto Plus LED Corp.

0.56" SMD Type LED Display

OPS-S5620B-GW

OPS-S5621B-GW

● REEL DIMENSIONS

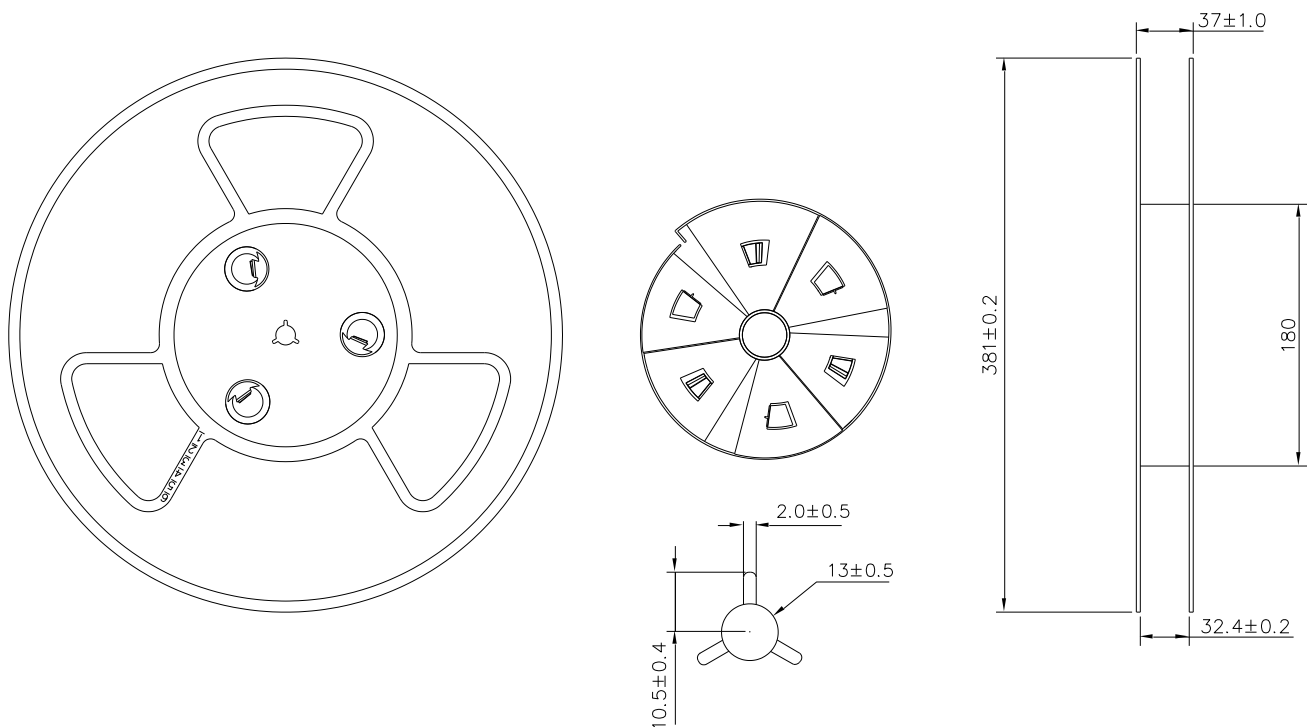

● PACKING & LABEL SPECIFICATIONS

