



Opto Plus LED Corp.
0.28” SMD Type LED Display
OPS-S2812LY-GW
OPS-S2811LY-GW

● **FEATURES**

- 0.28 inch (7.0 mm) Digit Height.
- SMD type.
- Low current operation.
- Gray face, White segment.
- RoHS compliant, Pb Free.

● **DESCRIPTION**

The OPS-S2812LY-GW & OPS-S2811LY-GW are 0.28 inch (7.0mm) height Single 7-segment displays.

This device utilizes Super Bright Yellow LED chip which are made from AlGaInP On a transparent GaAs, substrate.

The display has Gray face, White segment.

● **DEVICE**

PART NO	DESCRIPTION
OPS-S2812LY-GW	Common Anode
OPS-S2811LY-GW	Common Cathode

RoHS Compliance



Pb free.



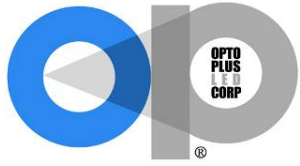

Opto Plus LED Corp.

0.28" SMD Type LED Display

OPS-S2812LY-GW

OPS-S2811LY-GW

● MECHANICAL DIMENSIONS

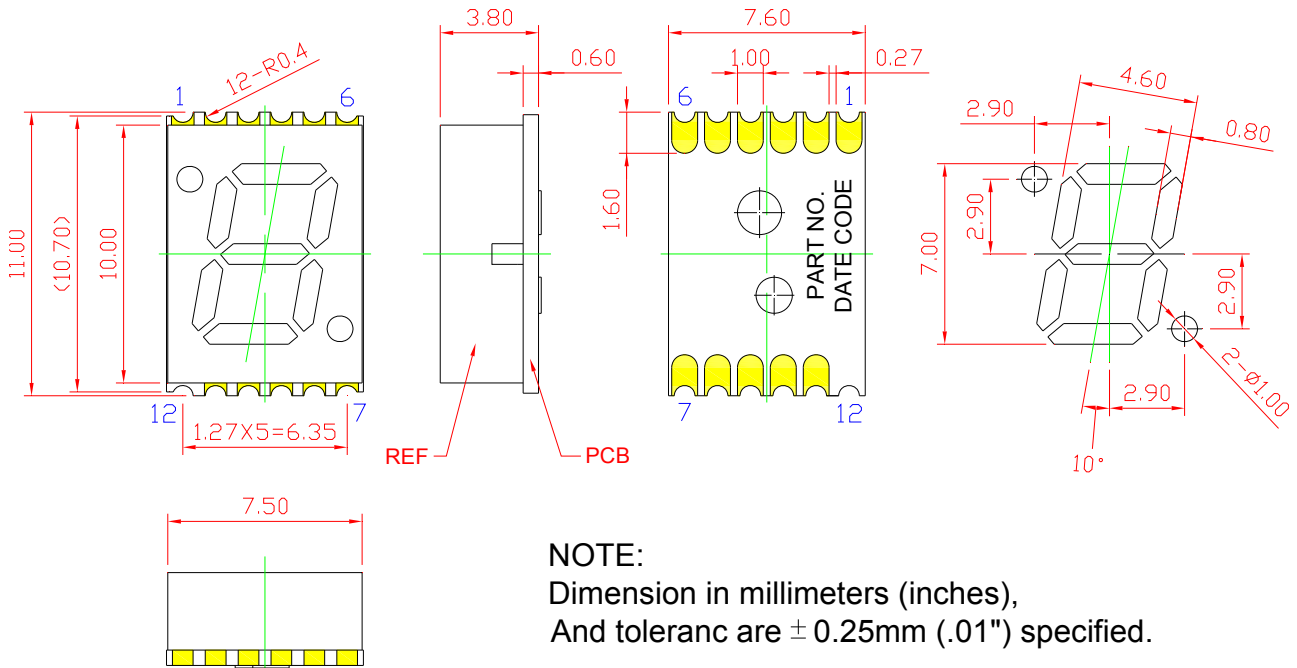

● TYPICAL INTERNAL EQUIVALENT CIRCUIT

Recommended Soldering Pattern

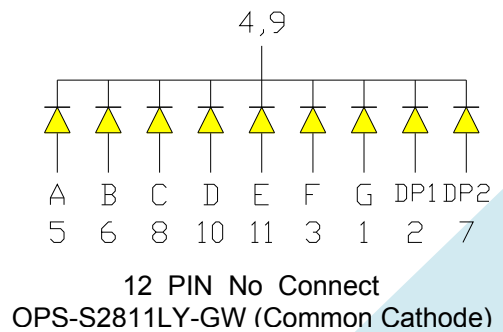
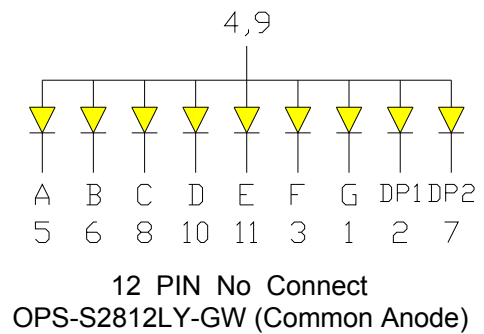
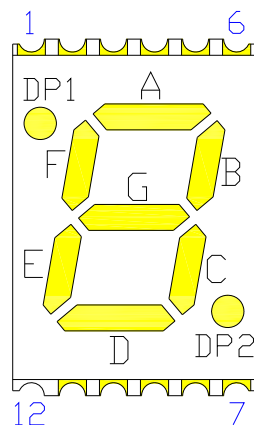
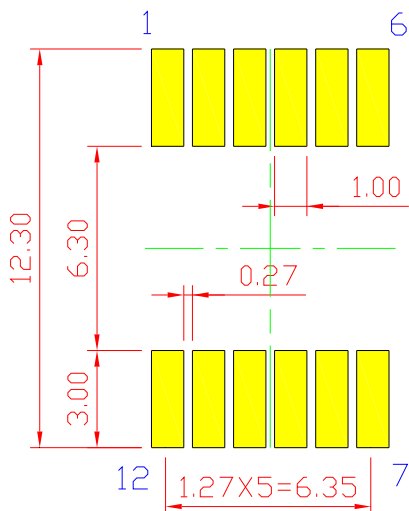

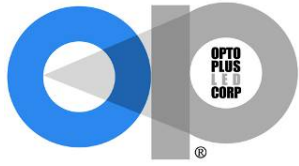

Opto Plus LED Corp.
0.28'' SMD Type LED Display
OPS-S2812LY-GW
OPS-S2811LY-GW

● **LY: SUPER BRIGHT YELLOW (AlGaInP/GaAs)**

ABSOLUTE MAXIMUM RATING AT Ta=25°C

Parameter	Symbol	Maximum Rating	Unit
Power dissipation	P_{AD}	70	mW
Derating liner from 25°C	-	0.28	mA / °C
Continuous forward current	I_{AF}	25	mA
Peak current (duty cycle 1/10, 1kHz)	I_{PF}	90	mA
Reverse voltage	V_R	5	V
Operating temperature	T_{OPR}	-40 to +105	°C
Storage temperature	T_{STG}	-40 to +105	°C

ELECTRICAL - OPTICAL CHARACTERISTICS AT Ta=25°C

Characteristic	Symbol	Condition	Min.	Type.	Max.	Unit
Forward Voltage, (Per Dice)	V_F	$I_F = 20\text{mA}$	-	2.0	2.6	V
Reverse Current, (Per Dice)	I_R	$V_R = 5\text{V}$	-	-	10	μA
Peak Wavelength	λ_P	$I_F = 20\text{mA}$	-	593	-	nm
Dominant Wavelength	λ_D	$I_F = 20\text{mA}$	-	590	-	nm
Luminous Intensity	I_V	$I_F = 20\text{mA}$	-	10	-	mcd
Spectral radiation bandwidth	$\Delta\lambda$	$I_F = 20\text{mA}$	-	20	-	nm

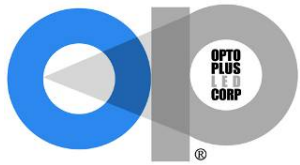

Opto Plus LED Corp.

0.28" SMD Type LED Display

OPS-S2812LY-GW

OPS-S2811LY-GW

● LY: SUPER BRIGHT YELLOW (AlGaInP/GaAs) CURVE

Typical Electro-optical Characteristic Curves
(25 °C Free Air Temperature Unless Otherwise Specified)

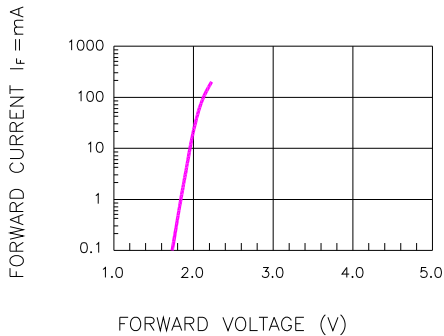

Fig.1 FORWARD CURRENT VS. FORWARD VOLTAGE

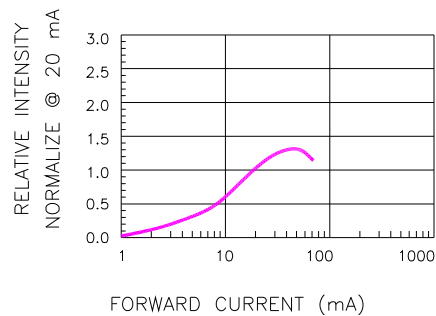

Fig.2 RELATIVE INTENSITY VS. FORWARD CURRENT

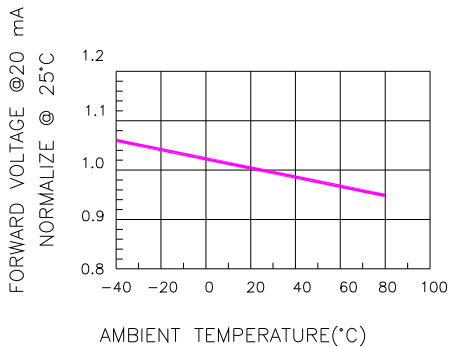

Fig.3 FORWARD VOLTAGE VS. TEMPERATURE

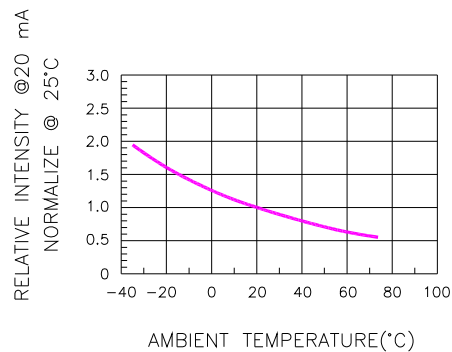

Fig.4 RELATIVE INTENSITY VS. TEMPERATURE

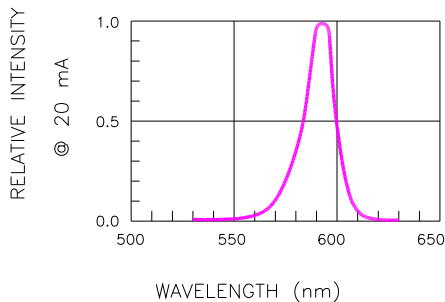

Fig.5 RELATIVE INTENSITY VS. WAVELENGTH

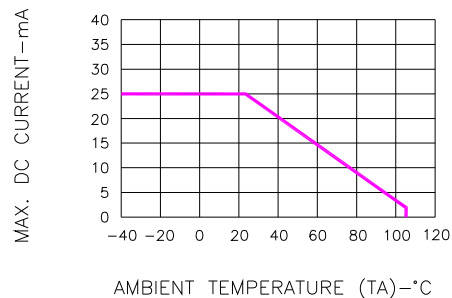
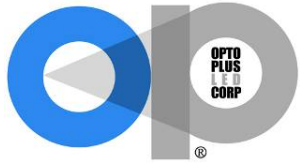

Fig.6 MAX. ALLOWABLE DC CURRENT VS. AMBIENT TEMPERATURE



Opto Plus LED Corp.
0.28" SMD Type LED Display
OPS-S2812LY-GW
OPS-S2811LY-GW

● **RECOMMEND SOLDERING PROFILE**

SMT Soldering Profile

Pb free reflow soldering Profile

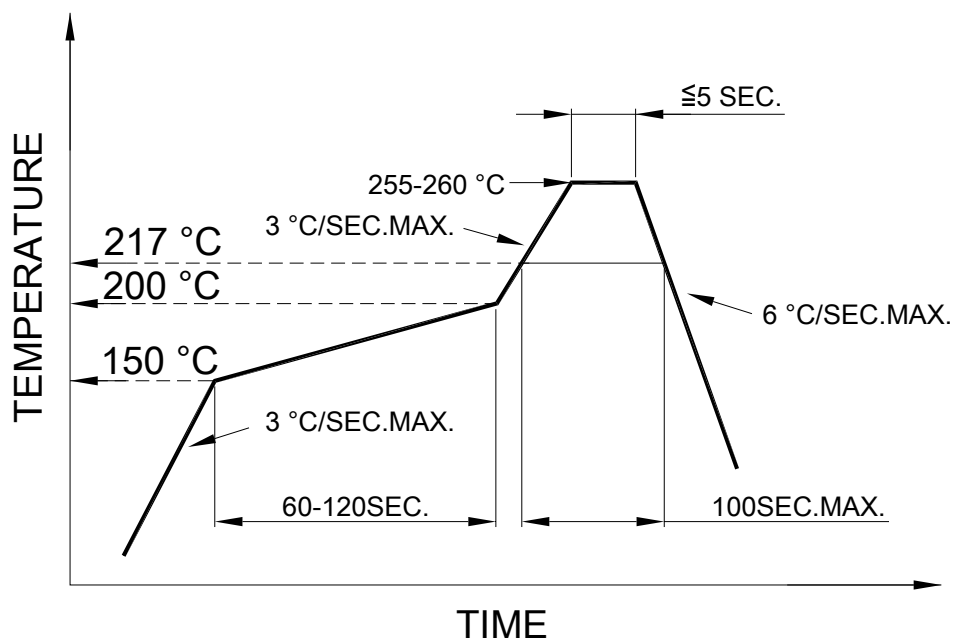

● **SOLDERING IRON**

Basic specification : ≤ 4 seconds when 260°C, If temperature is higher, time should be shorter (+10°C→1 sec). Power dissipation of iron should be smaller than 15W, and temperature should be controllable. Surface temperature of the device should be under 230°C.

● **REWORK**

Customer must finish rework within ≤ 3 sec under 350°C.