



LED Display
Product Data Sheet
LTS-4817CTB-PR

Spec No. :DS30-2013-0128
Effective Date: 04/19/2017
Revision: -

LITE-ON DCC

RELEASE

BNS-OD-FC001/A4

**LED DISPLAY
LTS-4817CTB-PR**

LED DISPLAY

LTS-4817CTB-PR

<u>Rev</u>	<u>Description</u>	<u>By</u>	<u>Date</u>
01	Preliminary Spec.	Reo Lin	03/31/2017
Above data for PD and Customer tracking only			
-	NPPR Received and Upload on System	Reo Lin	4/13/2017

LED DISPLAY LTS-4817CTB-PR

1. Description

The LTS-4817CTB-PR is a 0.39 inch (10.0mm) digit height single digit SMD display. This device uses InGaN blue LED chips (InGaN epi on Sapphire substrate). The display has gray face and white segments and suitable for reverse mount assembly.

1.1 Features

- 0.39 inch (10.0 mm) DIGIT HEIGHT
- CONTINUOUS UNIFORM SEGMENTS
- LOW POWER REQUIREMENT
- EXCELLENT CHARACTERS APPEARANCE
- HIGH BRIGHTNESS & HIGH CONTRAST
- WIDE VIEWING ANGLE
- SOLID STATE RELIABILITY
- CATEGORIZED FOR LUMINOUS INTENSITY.
- LEAD-FREE PACKAGE (ACCORDING TO ROHS)

1.2 Device

Part No	Description
InGaN Blue	Common Anode
LTS-4817CTB-PR	

**LED DISPLAY
LTS-4817CTB-PR**

2. Package Dimensions

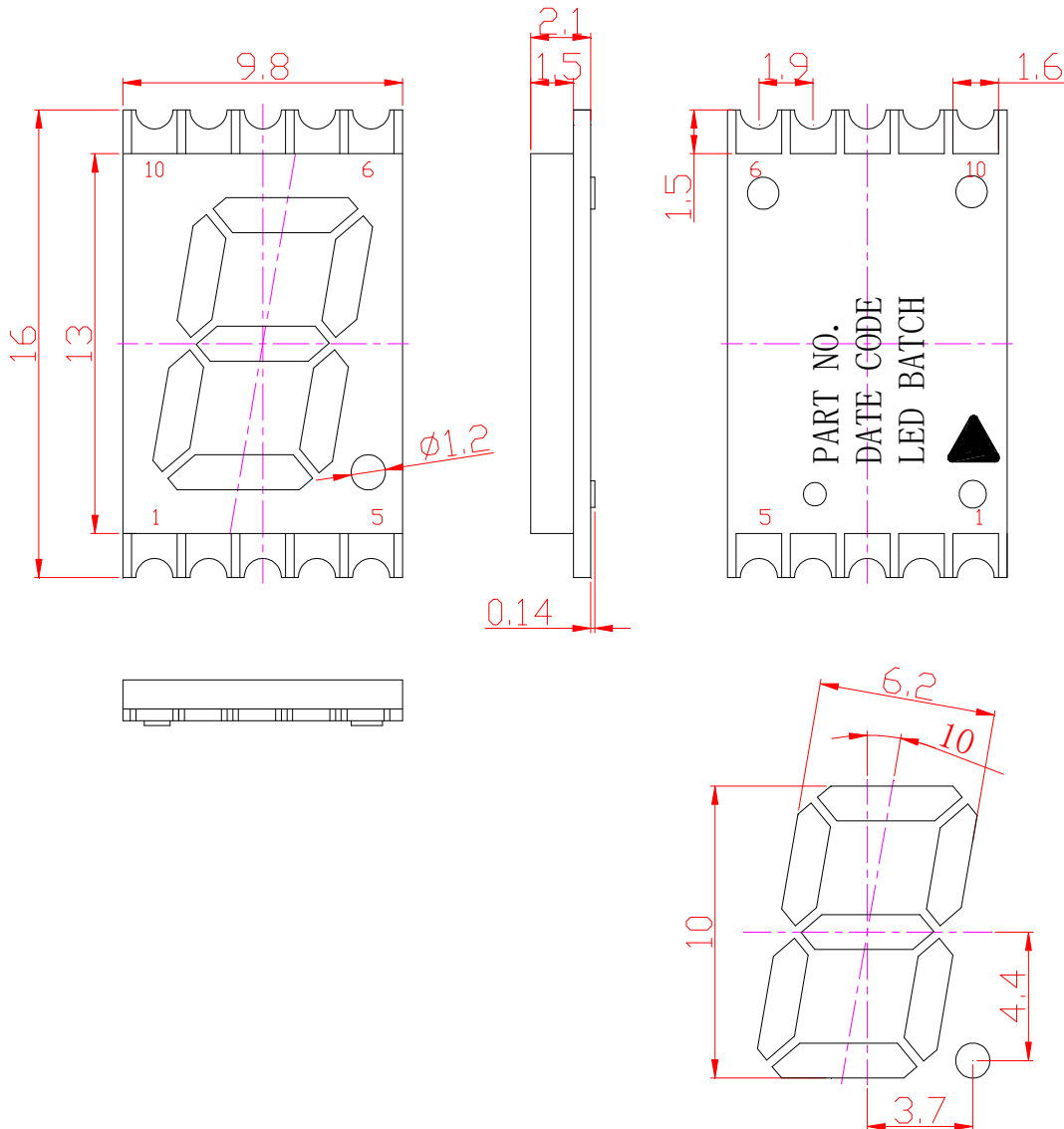

Notes :

1. All dimensions are in millimeters. Tolerances are ± 0.25 mm (0.01") unless otherwise noted
2. Foreign material on segment ≤ 10 mil
3. Ink contamination (surface) ≤ 20 mils
4. Bubble in segment ≤ 10 mil
5. Bending $\leq 1\%$ of reflector length
6. Plastic pin's burr max is 0.14 mm

**LED DISPLAY
LTS-4817CTB-PR**

3. Internal Circuit Diagram

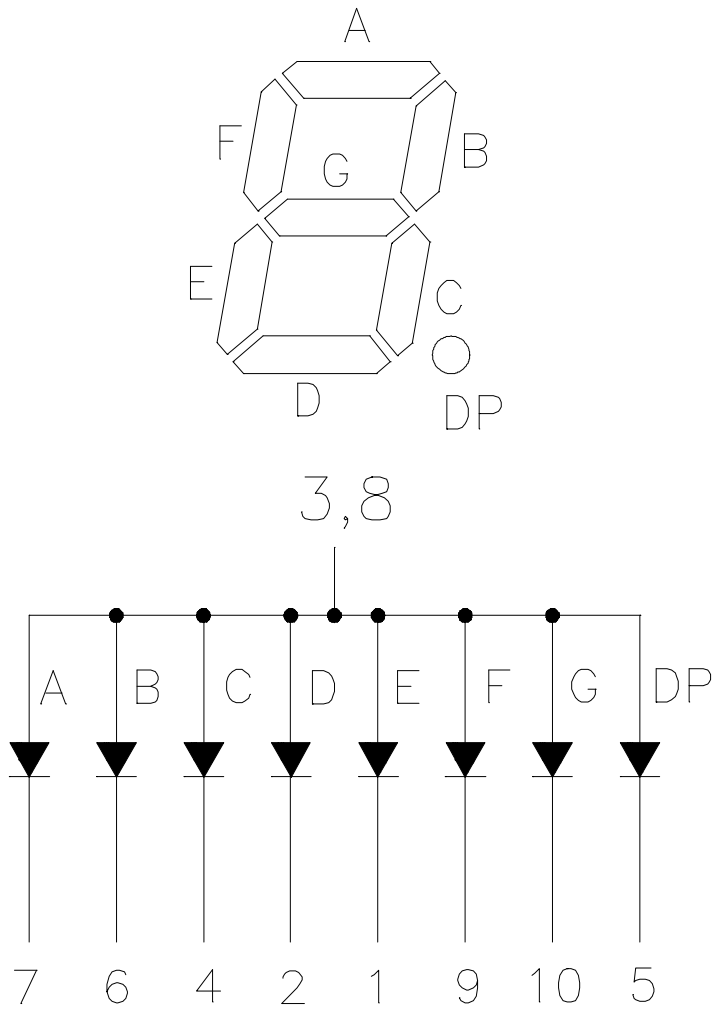

**LED DISPLAY
LTS-4817CTB-PR**

4. Pin Connection

No	Connection
1	CATHODE E
2	CATHODE D
3	COMMON ANODE
4	CATHODE C
5	CATHODE DP
6	CATHODE B
7	CATHODE A
8	COMMON ANODE
9	CATHODE F
10	CATHODE G

LED DISPLAY LTS-4817CTB-PR

5. Rating and Characteristics

5.1. CHIP LED Absolute Maximum Rating at Ta=25°C

Parameter	Maximum Rating	Unit
Power Dissipation Per Segment	70	mW
Peak Forward Current Per Segment (1/10 Duty Cycle, 0.1ms Pulse Width)	50	mA
Continuous Forward Current Per Segment Derating Linear From 25°C Per Segment	20 0.21	mA mA/°C
Operating Temperature Range	-35°C to +105°C	
Storage Temperature Range	-35°C to +105°C	
Iron Soldering Conditions: 1/16 inch Below Seating Plane for 3 Seconds at 260°C		

5.2. Chip LED Electrical / Optical Characteristics at Ta=25°C

Parameter	Symbol	MIN.	TYP.	MAX.	Unit	Test Condition
Average Luminous Intensity Per Segment	IV	8.4	26.8		mcd	IF=10mA
Peak Emission Wavelength	λ_p		468		nm	IF=20mA
Spectral Line Half-Width	$\Delta\lambda$		25		nm	IF=20mA
Dominant Wavelength	λ_d		470		nm	IF=20mA
Forward Voltage Per Chip	VF		3.3	3.8	V	IF=20mA
Reverse Current Per Segment ^(*)	IR			100	μ A	VR=5V
Luminous Intensity Matching Ratio (Similar Light Area)	IV-m			2:1		IF=10mA

Notes :

- Luminous intensity is measured with a light sensor and filter combination that approximates the CIE eye-response curve.
- Iv classification code is marked on each packing bag.
- Cross talk specification \leq 2.5%

LED DISPLAY LTS-4817CTB-PR

5.3. ESD (Electrostatic Discharge)

Static Electricity or power surge will damage the LED. Suggestions to prevent ESD damage:

- Use of a conductive wrist band or anti-electrostatic glove when handling these LEDs.
- All devices, equipment, and machinery must be properly grounded.
- Work tables, storage racks, etc. should be properly grounded.

Use ion blower to neutralize the static charge which might have built up on surface of the LED's plastic for N/D as a result of friction between LEDs during storage and handling.

LED DISPLAY LTS-4817CTB-PR

5.4. Typical Electrical / Optical Characteristics Curves

(25°C Ambient Temperature Unless Otherwise Noted)

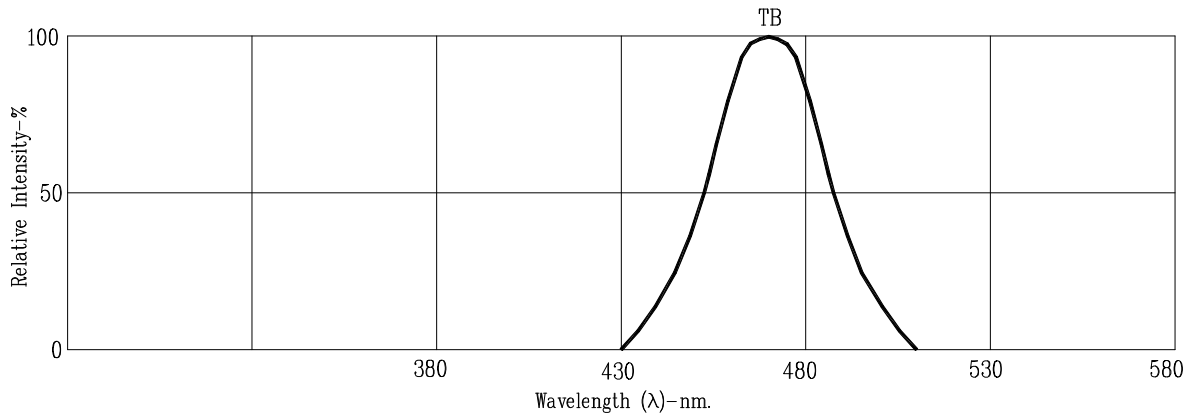

Fig1. RELATIVE INTENSITY VS. WAVELENGTH

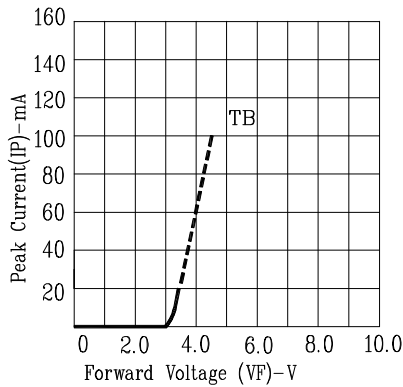

Fig3. FORWARD CURRENT VS. FORWARD VOLTAGE

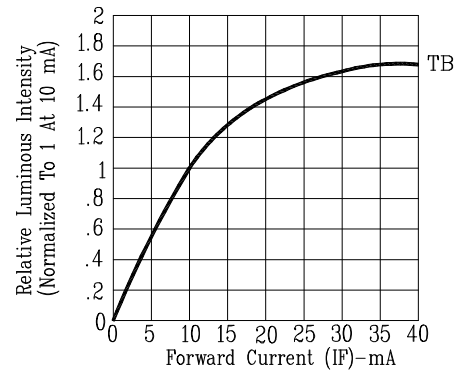

Fig4. RELATIVE LUMINOUS INTENSITY VS. FORWARD CURRENT

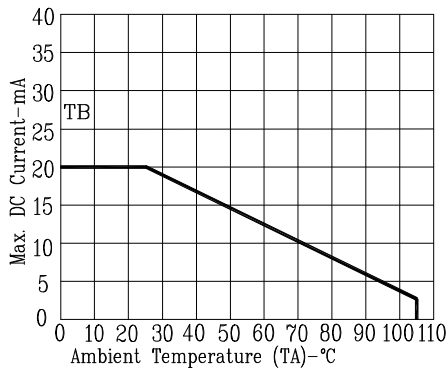

Fig5. MAX. ALLOWABLE DC CURRENT VS. AMBIENT TEMPERATURE.

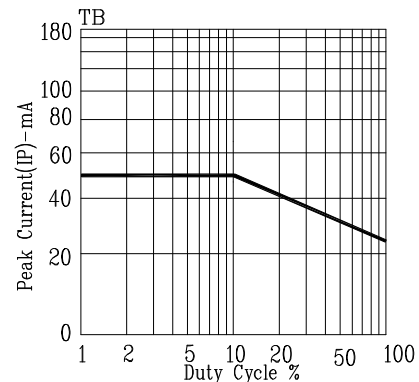

Fig6. MAX. PEAK CURRENT VS. DUTY CYCLE % (REFRESH RATE 1KHz)

NOTE: TB=InGaN/sapphire Blue

LED DISPLAY LTS-4817CTB-PR

6. SMT SOLDERING INSTRUCTION

(Number of reflow process shall be less than 2 times, and cooling process to normal temperature is required between the first and the second soldering process)

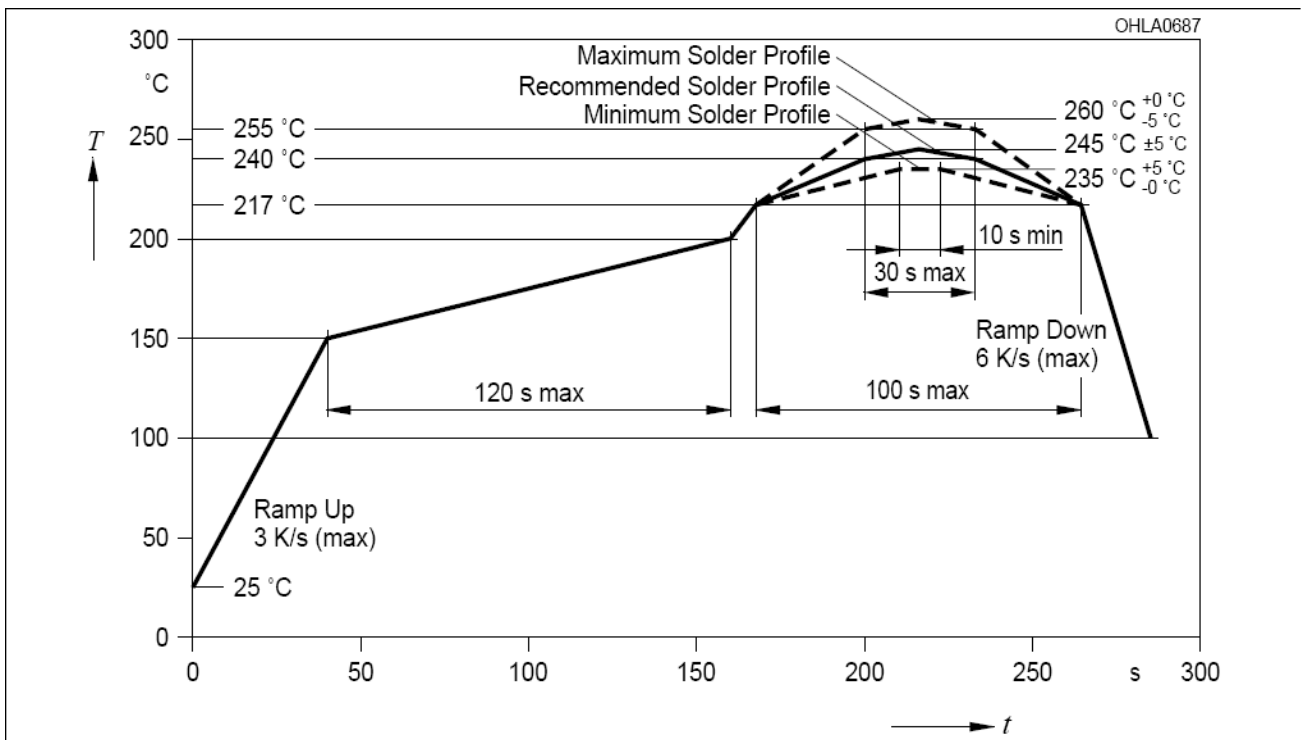

Notes :

1. Recommended soldering condition

Reflow Soldering (Two times only)		Soldering Iron (One time only)	
Pre-heat:	120~150°C.	Temperature	300°C Max.
Pre-heat time:	120sec. Max.	Soldering time	3sec. Max.
Peak temperature:	260°C Max.		
Soldering time:	5sec. Max.		

2. Number of reflow process shall be less than 2 times, and cooling process to normal temperature is required between the first and the second soldering process.

**LED DISPLAY
LTS-4817CTB-PR**

7. Recommended Soldering Pattern

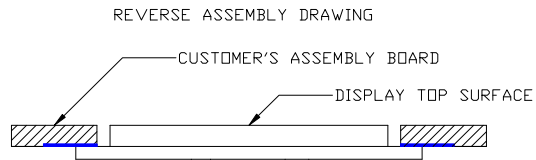
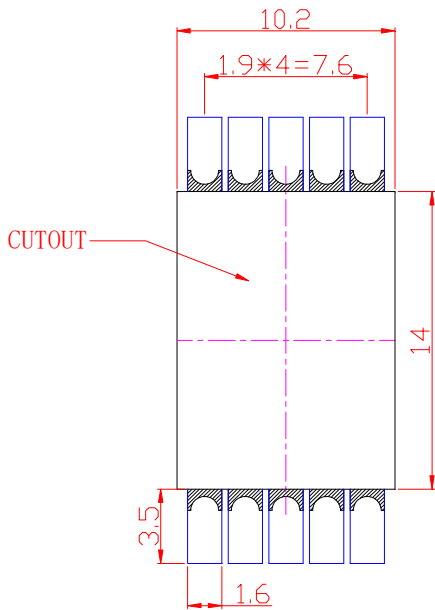

**LED DISPLAY
LTS-4817CTB-PR**

8. Packing Specification

8.1. Packing Reel Dimensions

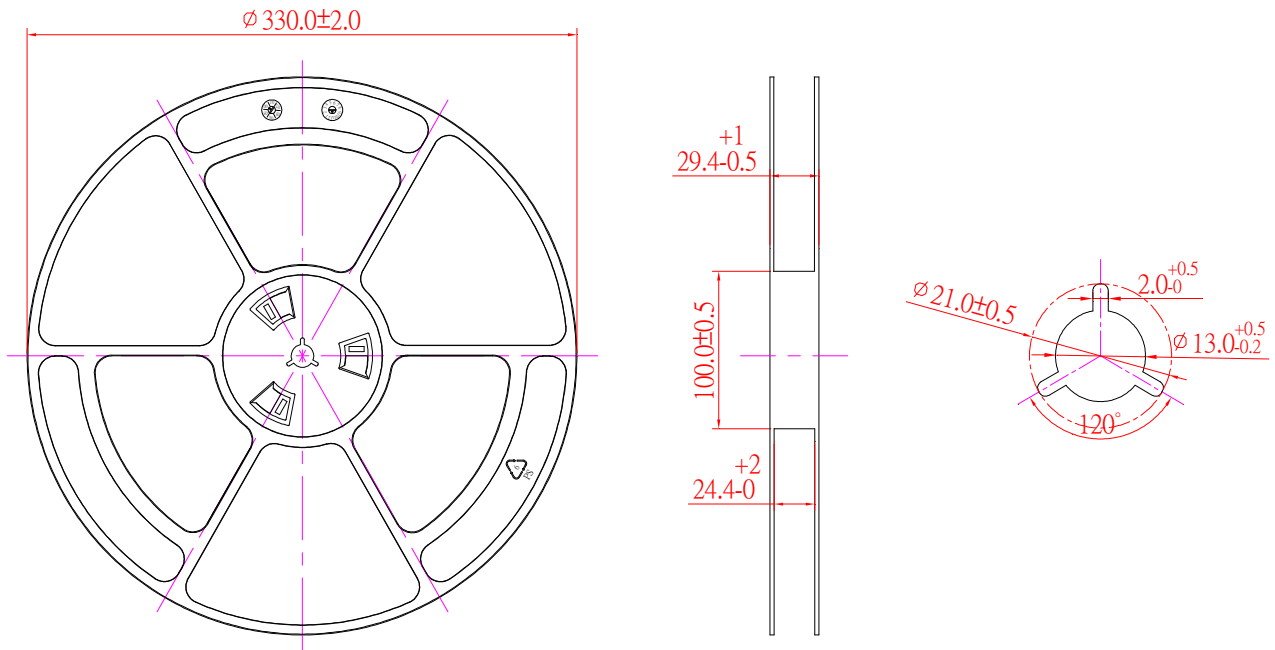

LED DISPLAY LTS-4817CTB-PR

8.2. Packing Carrier Dimensions

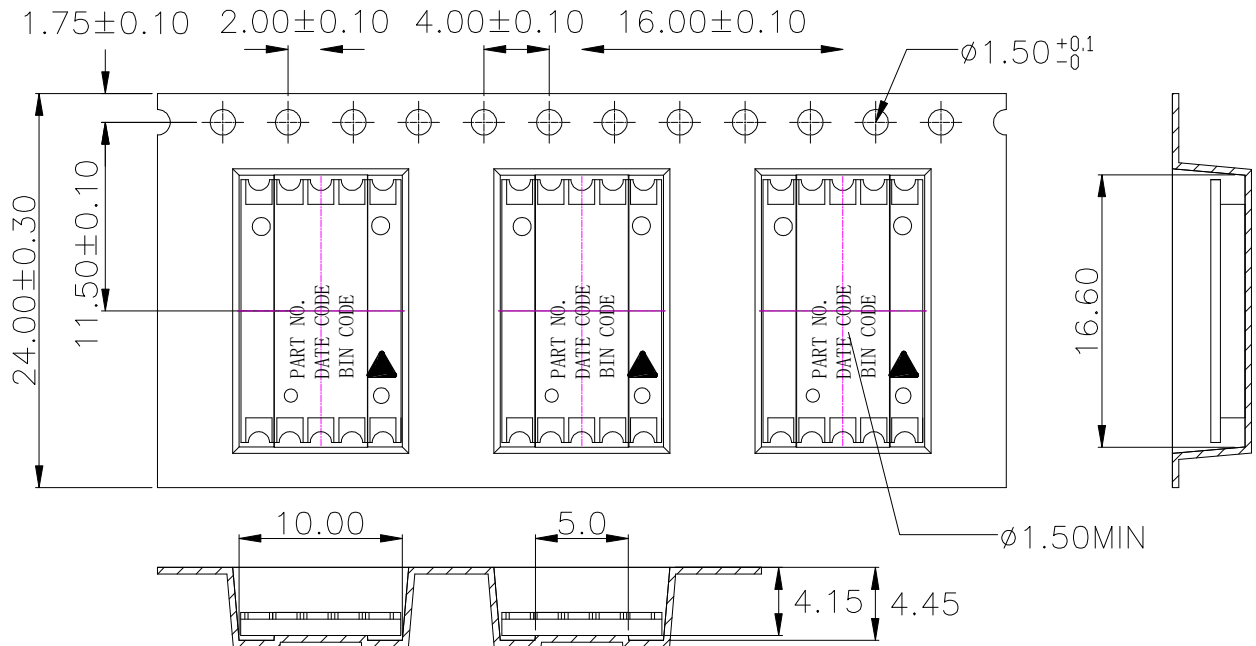

1. 10 sprocket hole pitch cumulative tolerance ± 0.20 .
2. Carrier camber is within 1 mm in 250 mm.
3. All dimensions meet EIA-481-C requirements.
4. Thickness : $0.40 \pm 0.05\text{mm}$.
5. Packing length per 22" reel : 45.50 Meters.
6. Component load per 13" reel : 800 pcs.
7. Minimum packing quantity is 200 pcs for remainders

8.3. Trailer part / Leader part

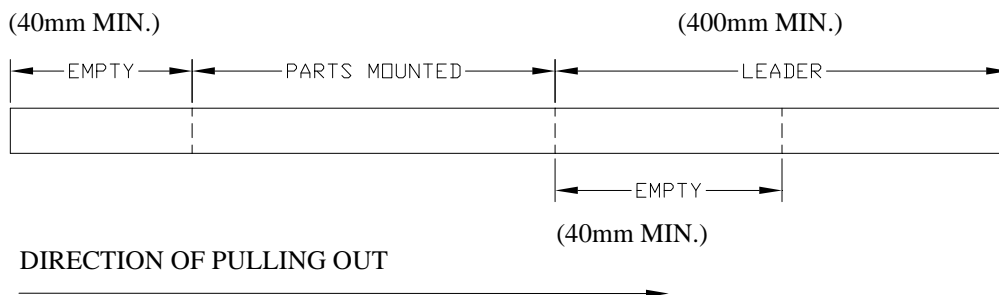

**LED DISPLAY
LTS-4817CTB-PR**

9. Moisture Proof Packing

All N/D SMD displays are shipped in moisture proof package. The displays should be stored at 30°C or less and 60 % RH or less. Once the package opened, moisture absorption begins.

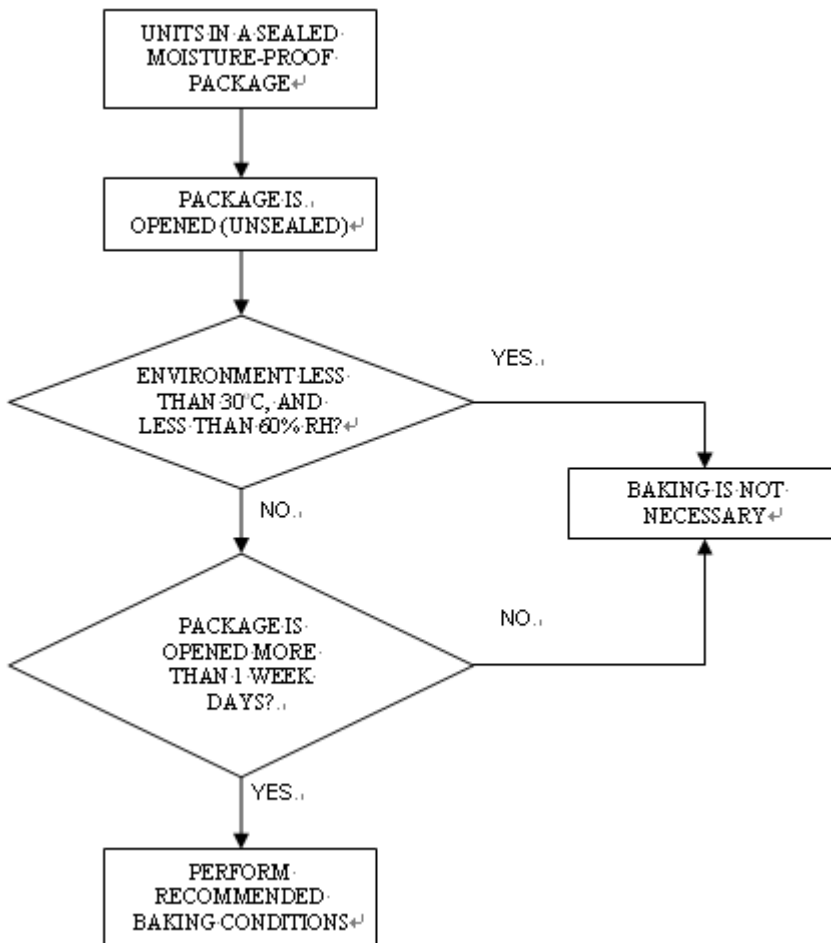

If the parts are not stored in dry conditions, they must be baked before reflow to prevent damage to the parts. Baking should only be done once

Package	Temperature	Time
In Reel	60°C	≥ 48hours
In Bulk	100°C	≥ 4hours
	125°C	≥ 2hours