

### SPECIFICATIONS

|                               |   |                                   |
|-------------------------------|---|-----------------------------------|
| <b>CUSTOMER</b>               | : | <b>PTC</b>                        |
| <b>SAMPLE CODE</b>            | : | <b>NSC1602LRS-JWT-H</b>           |
| <b>MASS PRODUCTION CODE</b>   | : | <b>NPC1602LRS-JWT-H</b>           |
| <b>SAMPLE VERSION</b>         | : | <b>01</b>                         |
| <b>SPECIFICATIONS EDITION</b> | : | <b>001</b>                        |
| <b>DRAWING NO. (Ver.)</b>     | : | <b>JLMD-NPC1602LRS-JWT-H _001</b> |
| <b>PACKAGING NO. (Ver.)</b>   | : | <b>JPKG-NPC1602LRS-JWT-H _001</b> |

**Customer Approved**

Date:

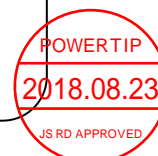

| Approved | Checked | Designer |
|----------|---------|----------|
| 閻偉       | 劉進      | 夏子豪      |

- Preliminary specification for design input
- Specification for sample approval

### POWER TIP TECH. CORP.

|                      |   |                      |  |
|----------------------|---|----------------------|--|
| <b>Headquarters:</b> | No.8, 6 <sup>th</sup> Road, Taichung Industrial Park, | TEL: 886-4-2355-8168 | E-mail: <a href="mailto:sales@powertip.com.tw">sales@powertip.com.tw</a> |
|                      | Taichung, Taiwan                                      | FAX: 886-4-2355-8166 | Http://www.powertip.com.tw   |
|                      | 台中市 407 工業區六路 8 號                                     |                      |  |



## Contents

### 1. SPECIFICATIONS

- 1.1 Features
- 1.2 Mechanical Specifications
- 1.3 Absolute Maximum Ratings
- 1.4 DC Electrical Characteristics
- 1.5 Optical Characteristics
- 1.6 Backlight Characteristics

### 2. MODULE STRUCTURE

- 2.1 Counter Drawing
- 2.2 Interface Pin Description
- 2.3 Timing Characteristics
- 2.4 Display Command
- 2.5 Character Pattern
- 2.6 Jumper(Setting different use)

### 3. QUALITY ASSURANCE SYSTEM

- 3.1 Quality Assurance Flow Chart
- 3.2 Inspection Specification

### 4. RELIABILITY TEST

- 4.1 Reliability Test Condition

### 5. PRECAUTION RELATING PRODUCT HANDLING

- 5.1 Safety
- 5.2 Handling
- 5.3 Storage
- 5.4 Terms of Warranty

#### Appendix :

- 1. LCM drawing
- 2. PKG drawing

Note : For detailed information please refer to IC data sheet : SITRONIX---ST7066U-0A

## 1. SPECIFICATIONS

### 1.1 Features

| Item              | Standard Value  |
|-------------------|---|
| Display Type      | 16*2 Characters   |
| LCD Type          | STN Gray , Positive , Transflective   |
| Driver Condition  | LCD Module : 1/16 Duty , 1/5 Bias   |
| Viewing Direction | 6 O'clock   |
| Interface         | 6800-series 8-bit parallel  |
| Driver IC         | ST7066U   |
| ROHS              | THIS PRODUCT CONFORMS THE ROHS OF PTC<br>Detail information please refer website :<br><a href="http://www.powertip.com.tw/news.php?area_id_view=1085560481/">http://www.powertip.com.tw/news.php?area_id_view=1085560481/</a> |

### 1.2 Mechanical Specifications

| Item              | Standard Value               | Unit |
|-------------------|------------------------------|------|
| Outline Dimension | 85.0 (L) * 30.0 (W) *12.7(H) | mm   |
| Viewing Area      | 66.0 (L) * 16.0 (W)          | mm   |
| Active Area       | 56.2 (L) * 11.5 (W)          | mm   |
| Character Size    | 2.95mm * 5.55mm              | mm   |
| Character Pitch   | 3.55mm * 5.95mm              | mm   |

Note : For detailed information please refer to LCM drawing

### 1.3 Absolute Maximum Ratings

| Item                      | Symbol           | Condition              | Min.                  | Max.                 | Unit |
|---------------------------|------------------|------------------------|-----------------------|----------------------|------|
| Power Supply Voltage      | V <sub>DD</sub>  | -                      | -0.3                  | 7.0                  | V    |
| LCD Driver Supply Voltage | V <sub>LCD</sub> | -                      | V <sub>DD</sub> -10.0 | V <sub>DD</sub> +0.3 | V    |
| Input Voltage             | V <sub>IN</sub>  | -                      | -0.3                  | V <sub>DD</sub> +0.3 | V    |
| Operating Temperature     | T <sub>OP</sub>  | -                      | -20                   | 70                   | °C   |
| Storage Temperature       | T <sub>ST</sub>  | -                      | -30                   | 80                   | °C   |
| Storage Humidity          | H <sub>D</sub>   | T <sub>a</sub> < 60 °C | -                     | 90                   | %RH  |

### 1.4 DC Electrical Characteristics

T<sub>a</sub> = 25°C

| Item                 | Symbol                | Condition  | Min.                | Typ. | Max.            | Unit |
|----------------------|-----------------------|--|---------------------|------|-----------------|------|
| Logic Supply Voltage | V <sub>DD</sub>       | -  | 4.5                 | 5.0  | 5.5             | V    |
| “H” Input Voltage    | V <sub>IH</sub>       | -  | 0.7 V <sub>DD</sub> | -    | V <sub>DD</sub> | V    |
| “L” Input Voltage    | V <sub>IL</sub>       | -  | -0.3                | -    | 0.6             | V    |
| “H” Output Voltage   | V <sub>OH</sub>       | I <sub>OH</sub> =-0.1mA                            | 3.9                 | -    | V <sub>DD</sub> | V    |
| “L” Output Voltage   | V <sub>OL</sub>       | I <sub>OL</sub> =0.1mA                             | -                   | -    | 0.4             | V    |
| Supply Current       | I <sub>DD</sub>       | V <sub>DD</sub> = 5.0 V ,V <sub>op</sub> = 4.5V *1 | -                   | 2.0  | 3.0             | mA   |
| LCM Driver Voltage   | V <sub>OP</sub><br>*2 | -20°C  | 4.4                 | 4.6  | 4.8             | V    |
|                      |                       | 25°C   | 4.3                 | 4.5  | 4.7             |      |
|                      |                       | 70°C   | 3.8                 | 4.0  | 4.2             |      |

NOTE: \*1 The Maximum current display

\*2 The VOP test point is (V<sub>DD</sub> -V<sub>O</sub>)

## 1.5 Optical Characteristics

LCD Panel : 1/16 Duty , 1/5 Bias ,  $V_{LCD} = 4.5V$  ,  $T_a = 25^{\circ}C$

| Item                             |       | Symbol      | Conditions   | Min. | Typ. | Max. | Unit              | Reference |
|----------------------------------|-------|-------------|--------------|------|------|------|-------------------|-----------|
| Response Time                    | Rise  | tr          | -            | -    | 80   | 120  | ms                | Note 2    |
|                                  | Fall  | tf          |              | -    | 150  | 225  |                   |           |
| Viewing angle range              | Rear  | $\theta+$   | $C \geq 2.0$ | -    | 40   | -    | Deg               | Note 1    |
|                                  | Front | $\theta-$   |              | -    | 40   | -    |                   |           |
|                                  | Left  | $\theta L$  |              | -    | 45   | -    |                   |           |
|                                  | Right | $\theta R$  |              | -    | 45   | -    |                   |           |
| Contrast Ratio                   |       | C           | -            | -    | 5    | -    | -                 | Note 3    |
| Average Brightness (with LCD) *2 |       | IV          | IF=100 mA    | 30   | 35   | -    | cd/m <sup>2</sup> | Note 4    |
| Wavelength (with LCD)            |       | $\lambda p$ |              | 568  | 571  | 574  | nm                |           |
| Uniformity *1                    |       | $\Delta B$  |              | 70   | -    | -    | %                 |           |

Note 4 :

1 :  $\Delta B = B(\min) / B(\max) * 100\%$

2 : Measurement Condition for Optical Characteristics:

a : Environment:  $25^{\circ}C \pm 5^{\circ}C$  /  $60 \pm 20\%R.H$  , no wind , dark room below 10 Lux at typical lamp current and typical operating frequency.

b : Measurement Distance:  $500 \pm 50$  mm , ( $\theta = 0^{\circ}$ )

c : Equipment: TOPCON BM-7 fast , (field  $1^{\circ}$ ) , after 10 minutes operation.

d : The uncertainty of the C.I.E coordinate measurement  $\pm 0.01$  , Average Brightness  $\pm 4\%$

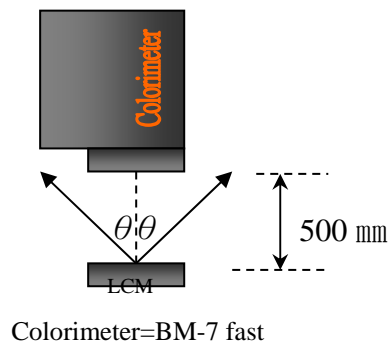
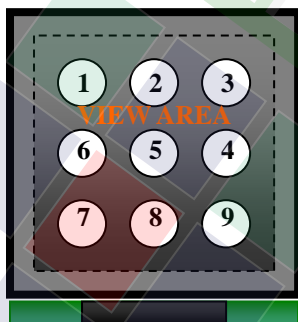

Note 1.

Optical characteristics-2

Viewing angle

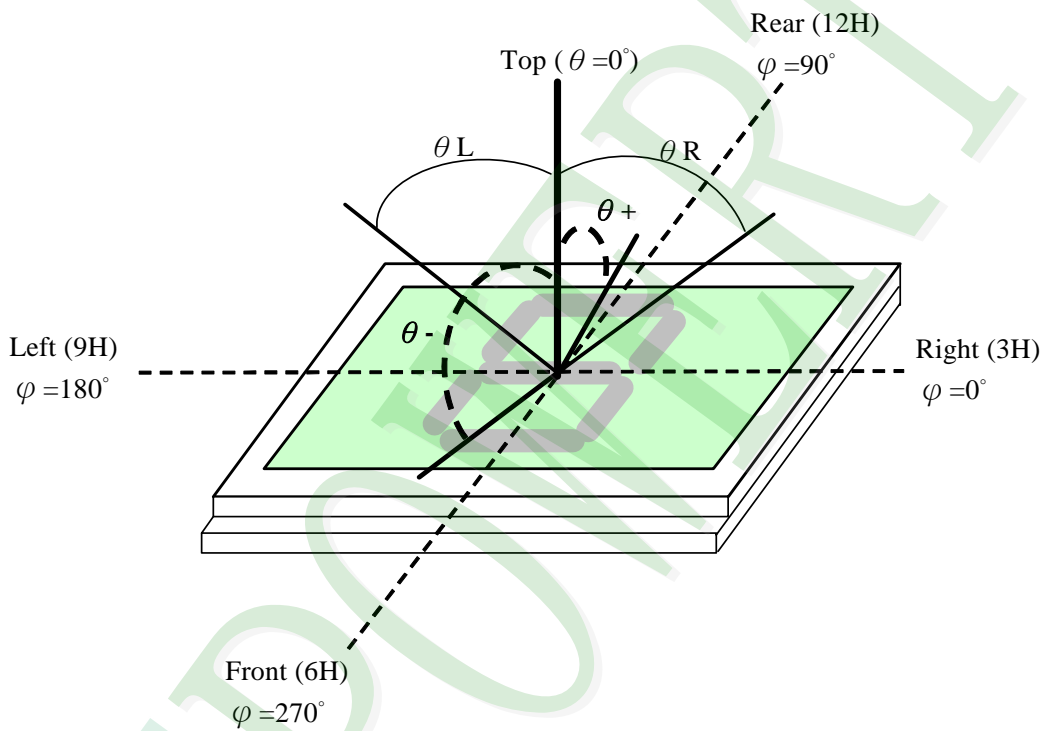

**Viewing angle**

Note 2.

Optical characteristics-3

Fig.2 Definition of response time

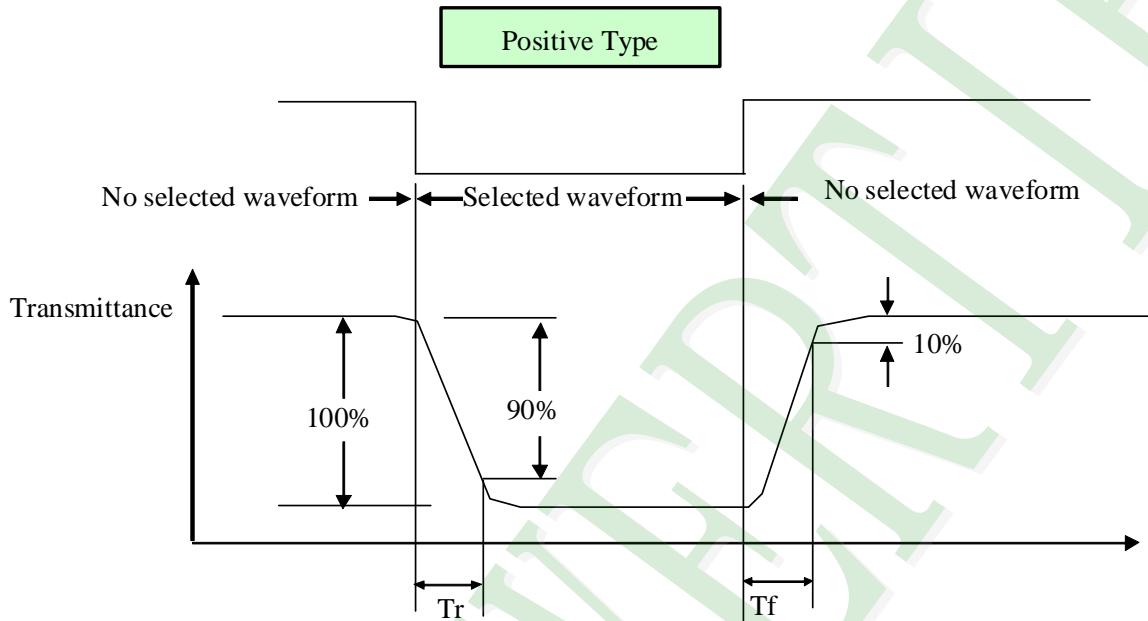



Electrical characteristics-2

※2 Drive waveform

$V_{op}$ : Drive voltage

$f_F$ : Frame frequency

$1/B$ : Bias

$f_D$ : Drive frequency

$N$ : Duty

(1) Selected waveform

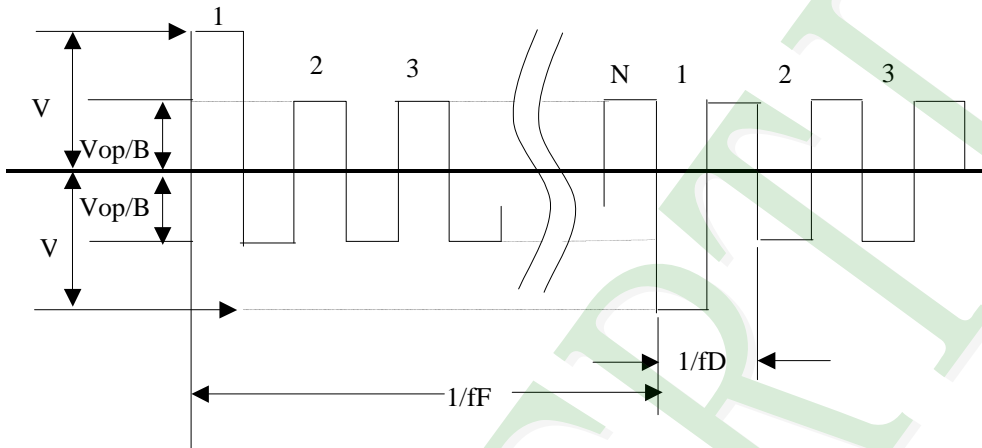

(2) Non- Selected wave form

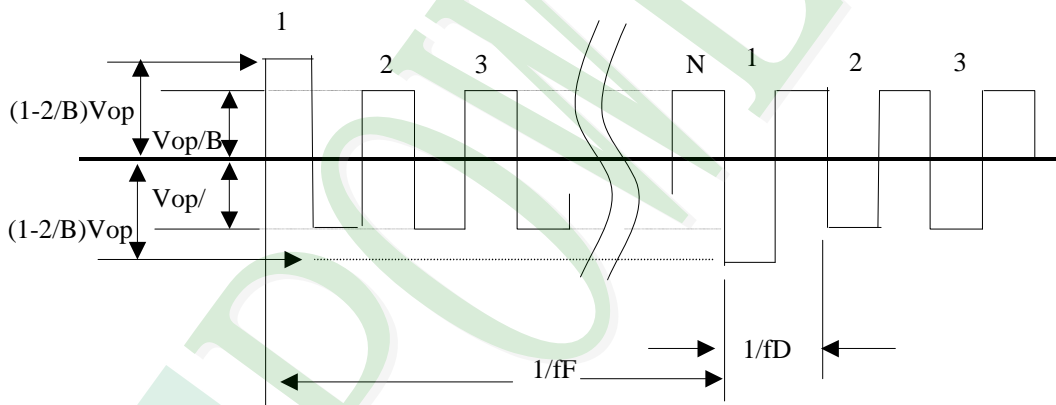

Note:

Frame frequency is defined as follows: Common side supply voltage peak - to - peak / 2 = 1 period

Note 3. : Definition of Vth

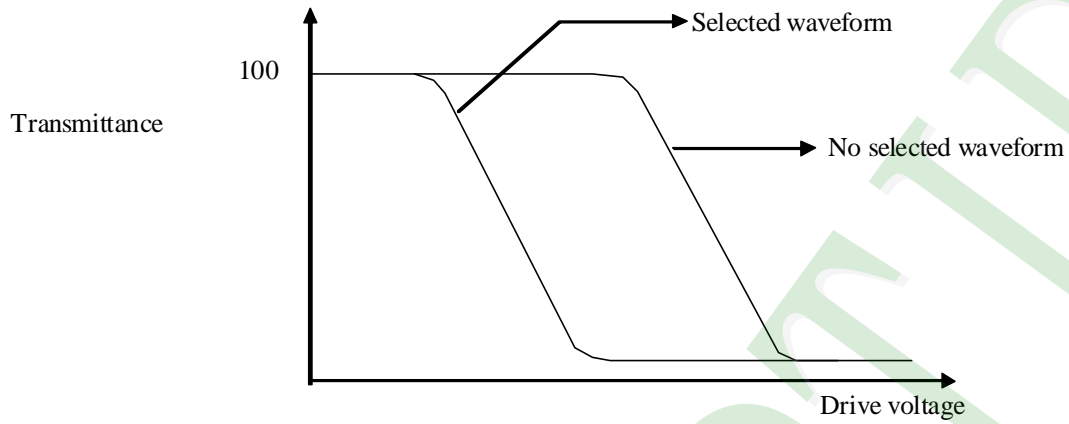

※1 Contrast ratio  
 = (Brightness in OFF state) / (Brightness in ON state)

Outline of Electro-Optical Characteristics Measuring System

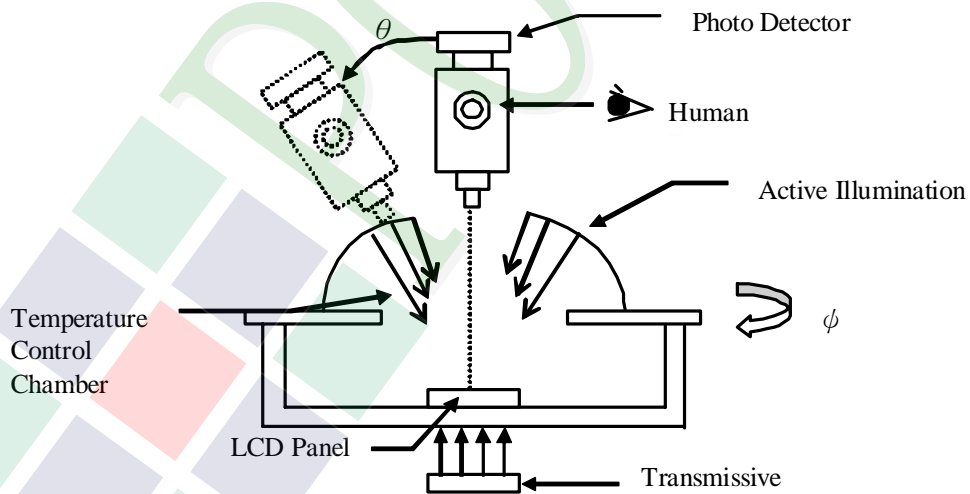

## 1.6 Backlight Characteristics

### Maximum Ratings

| Item              | Symbol | Conditions | Min. | Max. | Unit |
|-------------------|--------|------------|------|------|------|
| Forward Current   | IF     | Ta =25°C   | -    | 150  | mA   |
| Reverse Voltage   | VR     | Ta =25°C   | -    | 8    | V    |
| Power Dissipation | PD     | Ta =25°C   | -    | 660  | mW   |

### Electrical / Optical Characteristics

| Item                                | Symbol       | Conditions | Min. | Typ. | Max. | Unit              |
|-------------------------------------|--------------|------------|------|------|------|-------------------|
| Forward Voltage                     | VF           | IF= 100 mA | 4.0  | 4.2  | 4.4  | V                 |
| Average Brightness<br>(without LCD) | IV           |            | 165  | 190  | -    | cd/m <sup>2</sup> |
| Wavelength<br>(Without LCD)         | $\lambda p$  |            | 569  | 572  | 575  | nm                |
| Color                               | Yellow/Green |            |      |      |      |                   |

Internal Circuit Diagram:

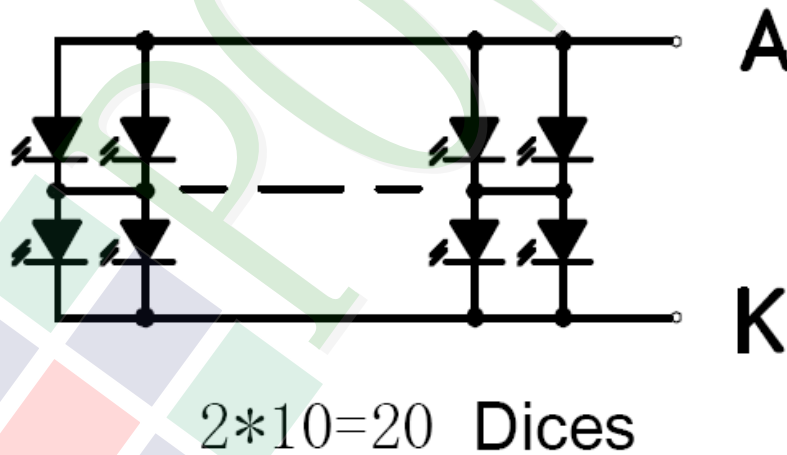

## 2. MODULE STRUCTURE

### 2.1 Counter Drawing

#### 2.1.1 LCM Mechanical Diagram

\* See Appendix

#### 2.1.2 Block Diagram

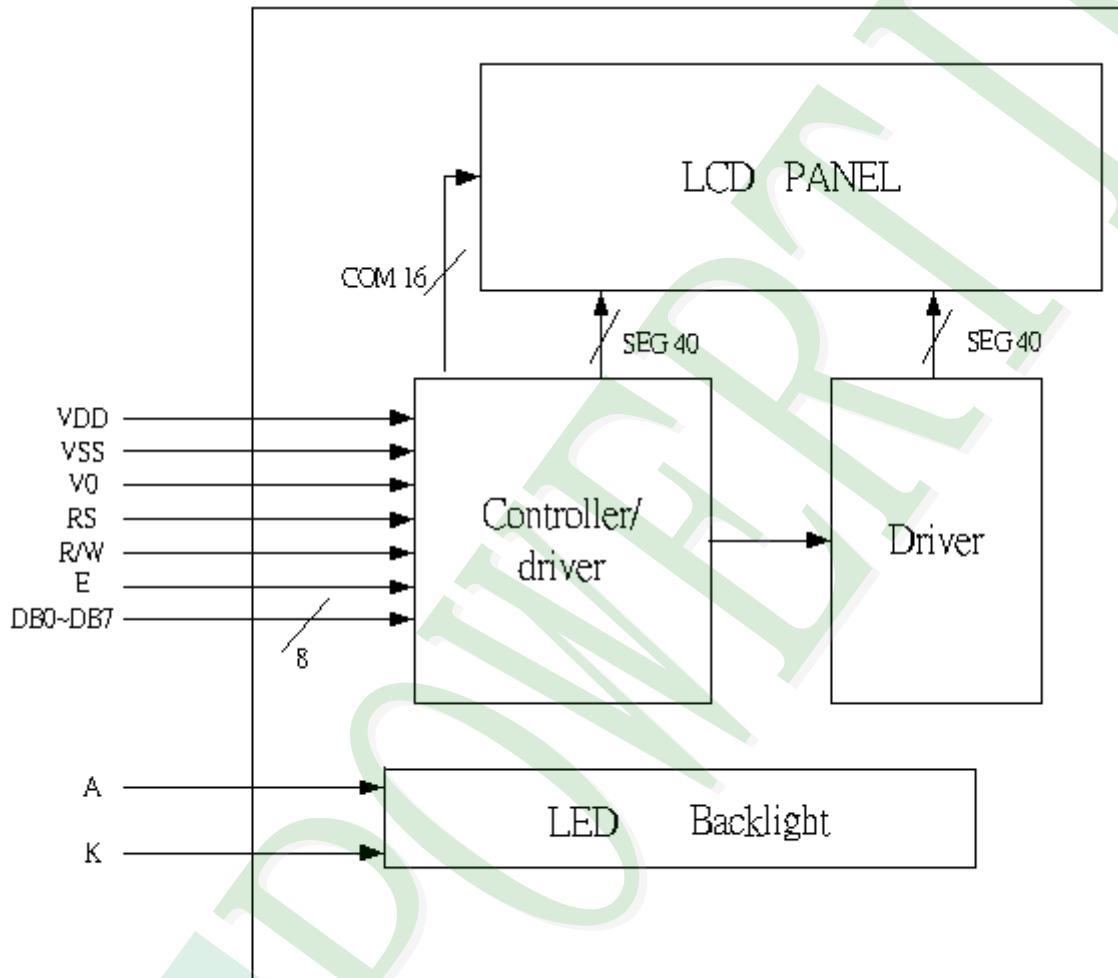

## 2.2 Interface Pin Description

| Pin No. | Symbol          | Signal Description  |
|---------|-----------------|---|
| 1       | V <sub>SS</sub> | Power Supply (V <sub>SS</sub> =0)   |
| 2       | V <sub>DD</sub> | Power Supply (5V)   |
| 3       | V <sub>O</sub>  | Operating voltage for LCD   |
| 4       | RS              | Register Selection input<br>High = Data register<br>Low = Instruction register (for write)<br>Busy flag address counter (for read)                                  |
| 5       | R/W             | Read/Write signal input is used to select the read/write mode<br>High = Read mode, Low = Write mode   |
| 6       | E               | Start enable signal to read or write the data   |
| 7       | DB0             | Four low order bi-directional three-state data bus lines. Use for data transfer between the MPU and the LCD module. These four are not used during 4-bit operation. |
| 8       | DB1             |   |
| 9       | DB2             |   |
| 10      | DB3             |   |
| 11      | DB4             | Four high order bi-directional three-state data bus lines. Used for data transfer between the MPU and the LCD module. DB7 can be used as a busy flag.               |
| 12      | DB5             |   |
| 13      | DB6             |   |
| 14      | DB7             |   |

### 2.2.1 Application Notes

#### Contrast Adjust

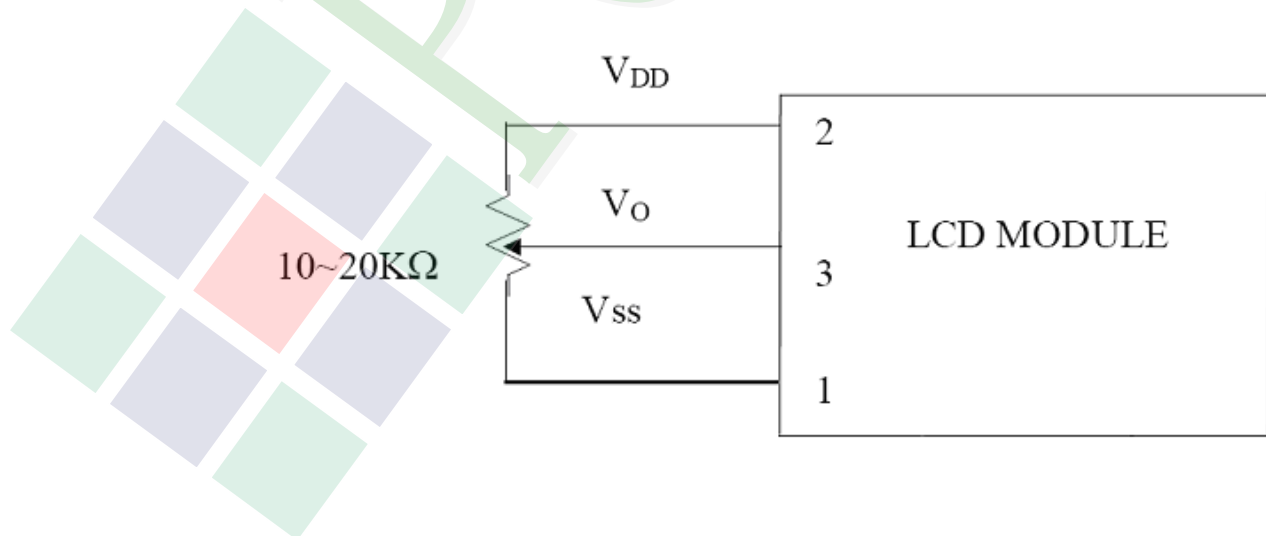

### 2.2.2 Refer Initial code

```
void initial()
{
    delay(40);

    write_com(0x01);

    delay(5);

    write_com(0x38);

    delay(5);

    write_com(0x0c);

    delay(5);

    write_com(0x06);

    delay(5);
}
```

### 2.3 Timing Characteristics

- Writing data from MPU to ST7066U

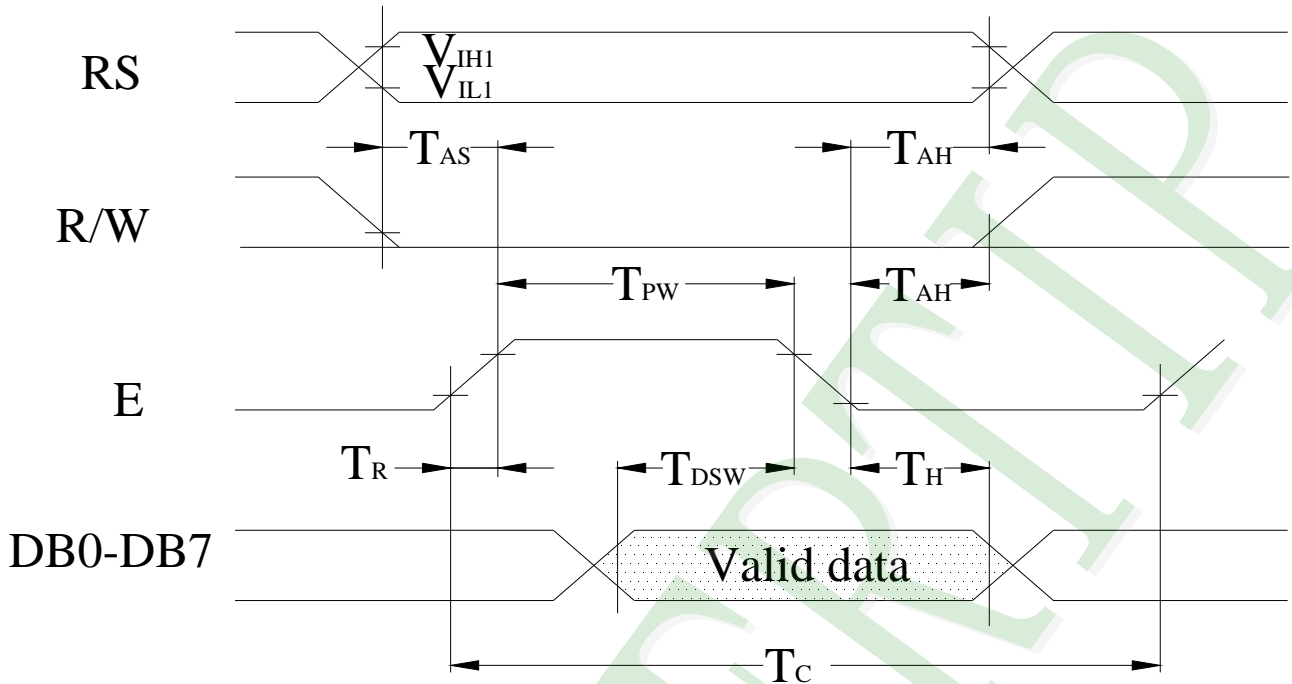

- Reading data from ST7066U to MPU

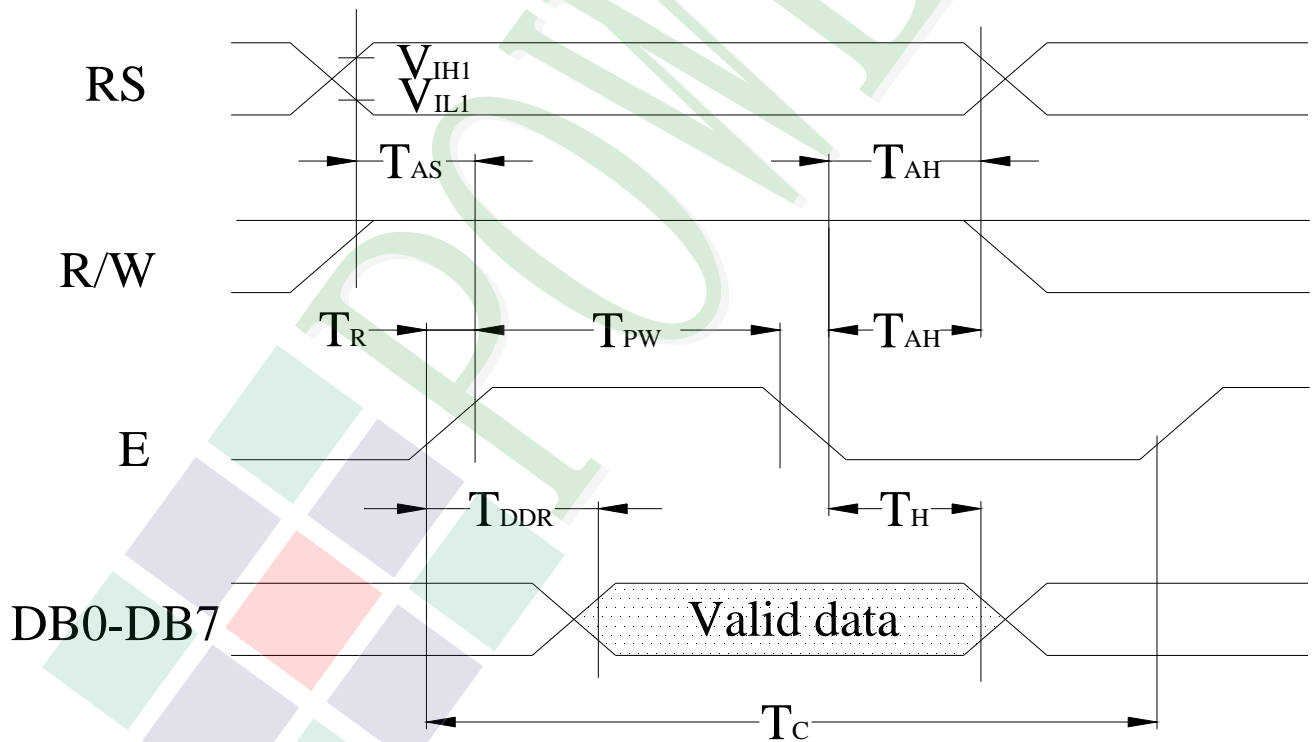

• Write Mode (Writing data from MPU to ST7066U)

(VDD = 5V, Ta=25°C)

| Symbol                          | Characteristics         | Test Condition  | Min. | Typ. | Max. | Unit |
|---------------------------------|-------------------------|-----------------|------|------|------|------|
| T <sub>C</sub>                  | Enable Cycle Time       | Pin E           | 1200 | -    | -    | ns   |
| T <sub>PW</sub>                 | Enable Pulse Width      | Pin E           | 140  | -    | -    | ns   |
| T <sub>R</sub> , T <sub>F</sub> | Enable Rise / Fall Time | Pin E           | -    | -    | 25   | ns   |
| T <sub>AS</sub>                 | Address Setup Time      | Pins: RS , RW,E | 0    | -    | -    | ns   |
| T <sub>AH</sub>                 | Address Hold Time       | Pins :RS,RW,E   | 10   | -    | -    | ns   |
| T <sub>D<sub>SW</sub></sub>     | Data Setup Time         | Pins:DB0~DB7    | 40   | -    | -    | ns   |
| T <sub>H</sub>                  | Data Hold Time          | Pins:DB0~DB7    | 10   | -    | -    | ns   |

• Read Mode (Reading data from ST7066U to MPU)

(VDD = 5V, Ta=25°C)

| Symbol                          | Characteristics         | Test Condition  | Min. | Typ. | Max. | Unit |
|---------------------------------|-------------------------|-----------------|------|------|------|------|
| T <sub>C</sub>                  | Enable Cycle Time       | Pin E           | 1200 | -    | -    | ns   |
| T <sub>PW</sub>                 | Enable Pulse Width      | Pin E           | 140  | -    | -    | ns   |
| T <sub>R</sub> , T <sub>F</sub> | Enable Rise / Fall Time | Pin E           | -    | -    | 25   | ns   |
| T <sub>AS</sub>                 | Address Setup Time      | Pins: RS , RW,E | 0    | -    | -    | ns   |
| T <sub>AH</sub>                 | Address Hold Time       | Pins :RS,RW,E   | 10   | -    | -    | ns   |
| T <sub>DDR</sub>                | Data Setup Time         | Pins:DB0~DB7    | -    | -    | 100  | ns   |
| T <sub>H</sub>                  | Data Hold Time          | Pins:DB0~DB7    | 10   | -    | -    | ns   |



For 4-bit interface date, only four bus lines (DB4 to DB7) are used for transfer

Example of busy flag check timing sequence

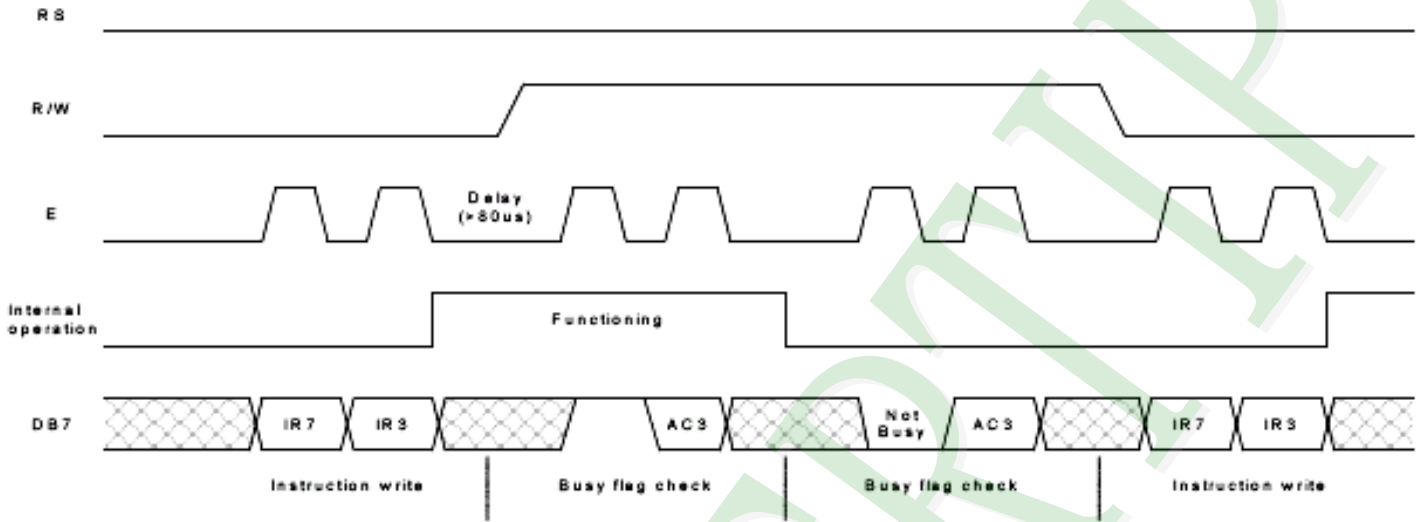

For 8-bit interface date, all eight bus lines (DB0 to DB7) are used

Example of busy flag check timing sequence

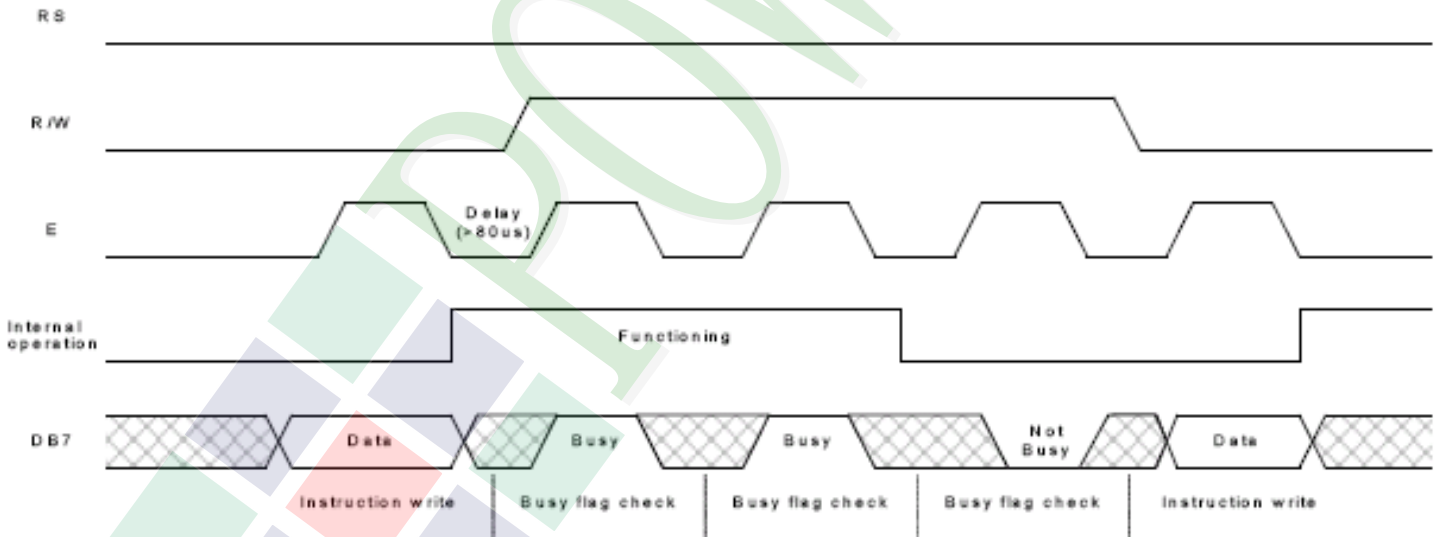

## 2.4 Display Command

| Instructions               | Instruction Code |     |      |      |      |      |      |      |      |      | Description | Description Time (270KHz)   |        |
|----------------------------|------------------|-----|------|------|------|------|------|------|------|------|-------------|---|--------|
|                            | RS               | R/W | DB 7 | DB 6 | DB 5 | DB 4 | DB 3 | DB 2 | DB 1 | DB 0 |             |   |        |
| Clear Display              | 0                | 0   | 0    | 0    | 0    | 0    | 0    | 0    | 0    | 0    | 1           | Write "20H" to DDRAM. and set DDRAM address to "00H" from AC.   | 1.52ms |
| Return Home                | 0                | 0   | 0    | 0    | 0    | 0    | 0    | 0    | 0    | 1    | ×           | Set DDRAM address to "00H" from AC and return cursor to it's original position if shifted. The contents of DDRAM are not changed. | 1.52ms |
| Entry Mode Set             | 0                | 0   | 0    | 0    | 0    | 0    | 0    | 0    | 1    | I/D  | S           | Sets cursor move direction and specifies display shift. These operations are performed during data write and read .               | 37μs   |
| Display ON/OFF             | 0                | 0   | 0    | 0    | 0    | 0    | 0    | 1    | D    | C    | B           | D=1 : entire display on<br>C=1 : cursor on<br>B=1 : cursor position on  | 37μs   |
| Cursor or Display Shift    | 0                | 0   | 0    | 0    | 0    | 1    | S/C  | R/L  | ×    | ×    | ×           | Set cursor moving and display shift control bit, and the the direction, without changing of DDRAM data.                           | 37μs   |
| Function Set               | 0                | 0   | 0    | 0    | 1    | DL   | N    | F    | ×    | ×    | ×           | DL: interface data is 8/4 bits<br>NL: number of line is 2/1<br>F: font size is 5×11/5×8   | 37μs   |
| Set CGRAM Address          | 0                | 0   | 0    | 1    | AC 5 | AC 4 | AC 3 | AC 2 | AC 1 | AC 0 | AC 0        | Set CGRAM address in address counter.   | 37μs   |
| Set DDRAM Address          | 0                | 0   | 1    | AC 6 | AC 5 | AC 4 | AC 3 | AC 2 | AC 1 | AC 0 | AC 0        | Set DDRAM address in address counter.   | 37μs   |
| Read Busy Flag and Address | 0                | 1   | B F  | AC 6 | AC 5 | AC 4 | AC 3 | AC 2 | AC 1 | AC 0 | AC 0        | Whether during internal operation or not can be known by reading BF. The contents of address counter can also be read.            | 0μs    |

|                    |   |   |    |    |    |    |    |    |    |    |   |            |
|--------------------|---|---|----|----|----|----|----|----|----|----|---|------------|
| Write Data to RAM  | 1 | 0 | D7 | D6 | D5 | D4 | D3 | D2 | D1 | D0 | Write data into internal RAM (DDRAM/CGRAM). | 37 $\mu$ s |
| Read Data from RAM | 1 | 1 | D7 | D6 | D5 | D4 | D3 | D2 | D1 | D0 | Read data from internal RAM (DDRAM/CGRAM).  | 37 $\mu$ s |

**Note:**

Be sure the ST7066U is not in the busy state (BF=0) before sending an instruction from the MPU to the ST7066.

If an instruction is sent without checking the busy flag , the time between the first instruction and next instruction will take much longer than the instruction time itself.

Before checking BF, be sure to wait at least 80us.. Do not keep “E” always “High” for checking BF

Refer to Instruction Table for the list of each instruction execution time .

## 2.5 Character Pattern ST7066-0T

| b7-b4<br>b3-b0 | 0000             | 0001 | 0010 | 0011 | 0100 | 0101 | 0110 | 0111 | 1000 | 1001 | 1010 | 1011 | 1100 | 1101 | 1110 | 1111 |
|----------------|------------------|------|------|------|------|------|------|------|------|------|------|------|------|------|------|------|
| 0000           | CG<br>RAM<br>(1) |      |      | 0    | 1    | 2    | 3    | 4    |      |      | 5    | 6    | 7    | 8    | 9    | A    |
| 0001           | (2)              | .    | !    | 0    | 1    | 2    | 3    | 4    |      |      | 5    | 6    | 7    | 8    | 9    | A    |
| 0010           | (3)              | "    | #    | 2    | 3    | 4    | 5    | 6    |      |      | 7    | 8    | 9    | 0    | 1    | 2    |
| 0011           | (4)              | \$   | %    | 3    | 4    | 5    | 6    | 7    |      |      | 8    | 9    | 0    | 1    | 2    | 3    |
| 0100           | (5)              | &    | '    | 4    | 5    | 6    | 7    | 8    |      |      | 9    | 0    | 1    | 2    | 3    | 4    |
| 0101           | (6)              | (    | *    | 5    | 6    | 7    | 8    | 9    |      |      | 0    | 1    | 2    | 3    | 4    | 5    |
| 0110           | (7)              | )    | +    | 6    | 7    | 8    | 9    | 0    |      |      | 1    | 2    | 3    | 4    | 5    | 6    |
| 0111           | (8)              | [    | ,    | 7    | 8    | 9    | 0    | 1    |      |      | 2    | 3    | 4    | 5    | 6    | 7    |
| 1000           | (1)              | <    | =    | 8    | 9    | 0    | 1    | 2    |      |      | 3    | 4    | 5    | 6    | 7    | 8    |
| 1001           | (2)              | >    | -    | 9    | 0    | 1    | 2    | 3    |      |      | 4    | 5    | 6    | 7    | 8    | 9    |
| 1010           | (3)              | *    | .    | 0    | 1    | 2    | 3    | 4    |      |      | 5    | 6    | 7    | 8    | 9    | A    |
| 1011           | (4)              | +    | ,    | 1    | 2    | 3    | 4    | 5    |      |      | 6    | 7    | 8    | 9    | A    | B    |
| 1100           | (5)              | <    | =    | 2    | 3    | 4    | 5    | 6    |      |      | 7    | 8    | 9    | A    | B    | C    |
| 1101           | (6)              | >    | -    | 3    | 4    | 5    | 6    | 7    |      |      | 8    | 9    | A    | B    | C    | D    |
| 1110           | (7)              | *    | .    | 4    | 5    | 6    | 7    | 8    |      |      | 9    | A    | B    | C    | D    | E    |
| 1111           | (8)              | +    | ,    | 5    | 6    | 7    | 8    | 9    |      |      | A    | B    | C    | D    | E    | F    |

### 3. QUALITY ASSURANCE SYSTEM

#### 3.1 Quality Assurance Flow Chart

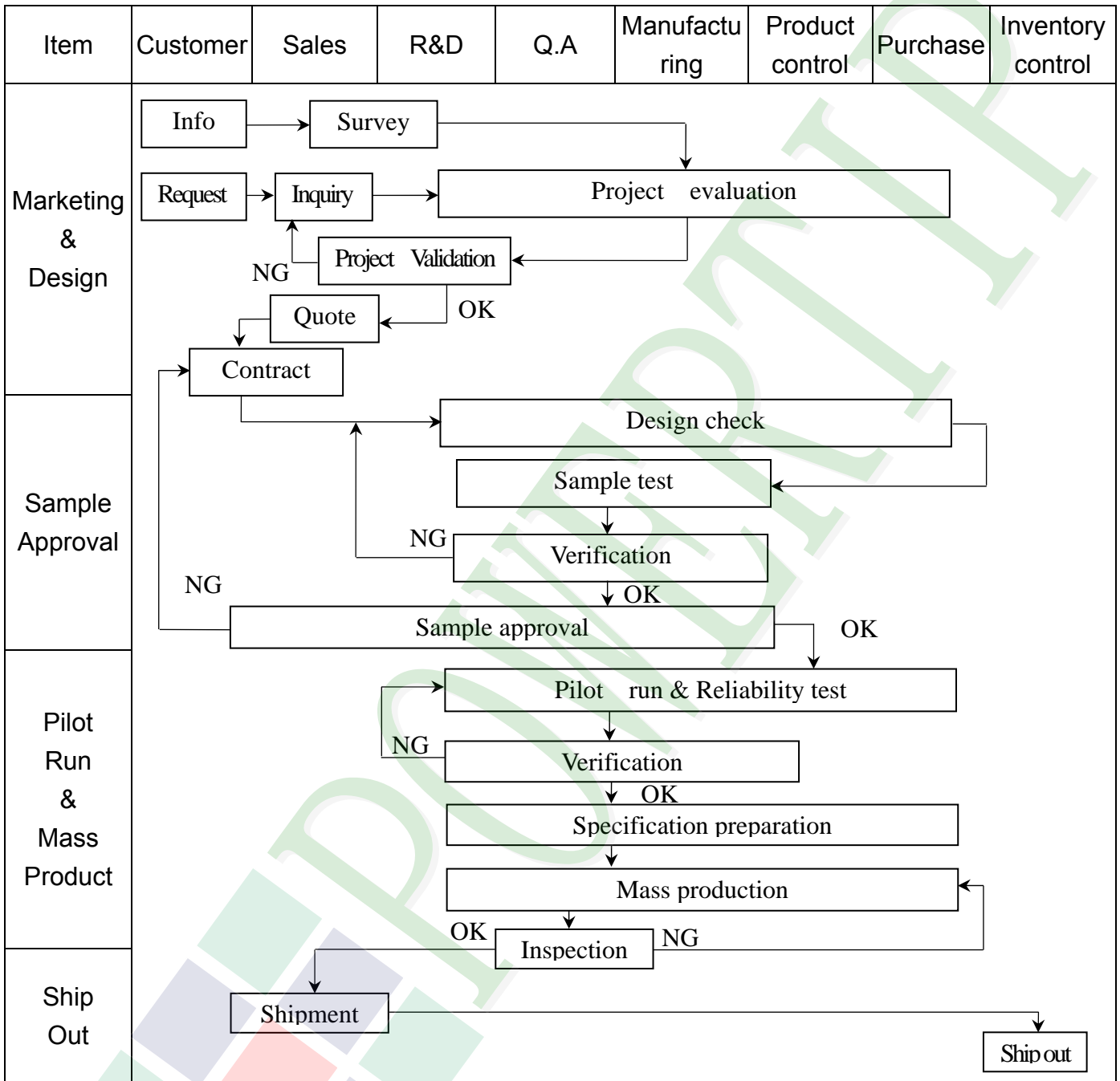

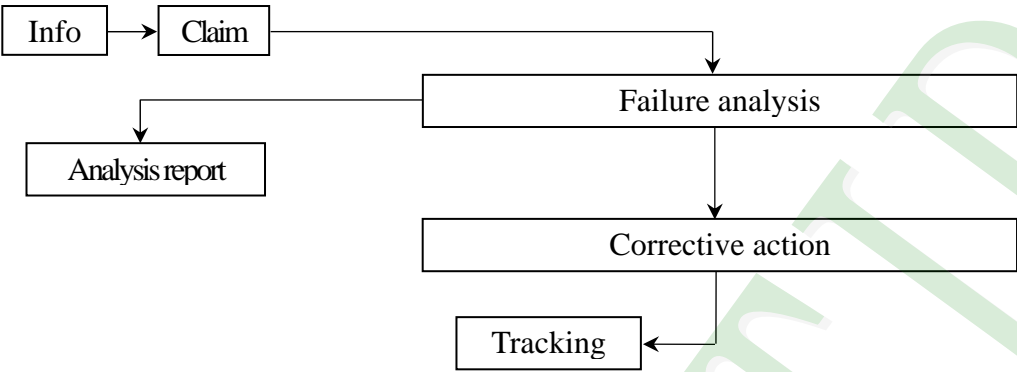
| Item          | Customer  | Sales | R&D | Q.A | Manufacturing   | Product control | Purchase | Inventory control |
|---------------|---|-------|-----|-----|---|-----------------|----------|-------------------|
| Sales Service |  <pre> graph TD     Info[Info] --&gt; Claim[Claim]     Claim --&gt; FA[Failure analysis]     Claim --&gt; AR[Analysis report]     FA --&gt; CA[Corrective action]     CA --&gt; Tracking[Tracking]         </pre> |       |     |     |   |                 |          |                   |
| Q.A Activity  | 1. ISO 9001 Maintenance Activities<br>3. Equipment calibration<br>5. Standardization Management   |       |     |     | 2. Process improvement proposal<br>4. Education And Training Activities |                 |          |                   |



### 3.2 Inspection Specification

◆Scope : The document shall be applied to LCD Module for Monotype and Color STN(Ver. B01).

◆Inspection Standard : MIL-STD-105E Table Normal Inspection Single Sampling Level II .

◆Equipment : Gauge 、 MIL-STD 、 Powertip Tester 、 Sample

◆Defect Level : Major Defect AQL : 0.4 ; Minor Defect : AQL : 1.5 .

◆OUT Going Defect Level : Sampling .

◆Manner of appearance test :

(1). The test be under 20W×2 fluorescent light ' and distance of view must be at 30 cm.

(2). Standard of inspection : (Unit : mm)

(3). The test direction is base on about around 45° of vertical line. (Fig. 1)

(4). Definition of area . (Fig. 2)

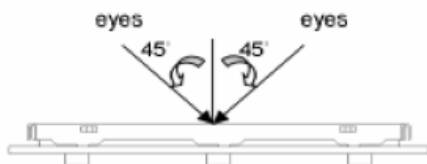

Fig.1

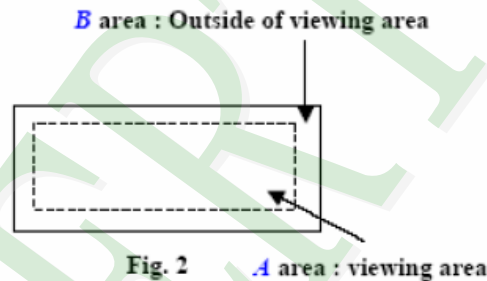
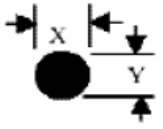
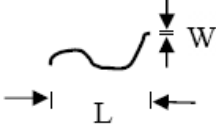

Fig. 2

◆ Specification:

| NO | Item               | Criterion   | Level |
|----|--------------------|---|-------|
| 01 | Product condition  | 1. 1 The part number is inconsistent with work order of Production.     | Major |
|    |                    | 1. 2 Mixed production types.  | Major |
|    |                    | 1. 3 Assembled in inverse direction.                                    | Major |
| 02 | Quantity           | 2. 1 The quantity is inconsistent with work order of production.        | Major |
| 03 | Outline dimension  | 3. 1 Product dimension and structure must conform to Structure diagram. | Major |
| 04 | Electrical Testing | 4. 1 Missing line character and icon.                                   | Major |
|    |                    | 4. 2 No function or no display.   | Major |
|    |                    | 4. 3 Output data is error.  | Major |
|    |                    | 4. 4 LCD viewing angle defect.  | Major |
|    |                    | 4. 5 Current consumption exceeds product specifications.                | Major |

| NO                             | Item  | Criterion   | Level                          |                   |  |        |        |                  |                 |  |                         |   |        |                         |   |                |   |                |           |  |                   |  |            |           |        |        |     |               |                 |        |              |                      |   |              |                       |     |             |               |  |       |
|--------------------------------|---|---|--------------------------------|-------------------|--|--------|--------|------------------|-----------------|--|-------------------------|---|--------|-------------------------|---|----------------|---|----------------|-----------|--|-------------------|--|------------|-----------|--------|--------|-----|---------------|-----------------|--------|--------------|----------------------|---|--------------|-----------------------|-----|-------------|---------------|--|-------|
| 05                             | <p>Black or white dot、scratch、contamination</p> <p>Round type</p>  <p><math>\Phi=(x+y)/2</math></p> <p>Line type</p>  | <p>5. 1 Round type:</p> <p>5. 1. 1 display only :</p> <ul style="list-style-type: none"> <li>• White and black spots on display <math>\leq 0.30</math> mm , no more than 4 white or black spots present.</li> <li>• Densely spaced : NO more than two spots or lines within 3 mm.</li> </ul> <p>5. 1. 2 Non-display :</p> <table border="1"> <thead> <tr> <th rowspan="2">Dimension (diameter : <math>\Phi</math>)</th> <th colspan="2">Acceptance (Q'ty)</th> </tr> <tr> <th>A area</th> <th>B area</th> </tr> </thead> <tbody> <tr> <td><math>\Phi \leq 0.10</math></td> <td colspan="2">Accept no dense</td> </tr> <tr> <td><math>0.10 &lt; \Phi \leq 0.20</math></td> <td>3</td> <td rowspan="2">Ignore</td> </tr> <tr> <td><math>0.20 &lt; \Phi \leq 0.30</math></td> <td>2</td> </tr> <tr> <td>Total quantity</td> <td colspan="2">4</td> </tr> </tbody> </table> <p>5. 1. 3 Line type:</p> <table border="1"> <thead> <tr> <th colspan="2">Dimension</th> <th colspan="2">Acceptance (Q'ty)</th> </tr> <tr> <th>Length (L)</th> <th>Width (W)</th> <th>A area</th> <th>B area</th> </tr> </thead> <tbody> <tr> <td>---</td> <td><math>W \leq 0.03</math></td> <td>Accept no dense</td> <td rowspan="3">Ignore</td> </tr> <tr> <td><math>L \leq 3.0</math></td> <td><math>0.03 &lt; W \leq 0.05</math></td> <td rowspan="2">4</td> </tr> <tr> <td><math>L \leq 2.5</math></td> <td><math>0.05 &lt; W \leq 0.075</math></td> </tr> <tr> <td>---</td> <td><math>W &gt; 0.075</math></td> <td colspan="2">As round type</td> </tr> </tbody> </table> | Dimension (diameter : $\Phi$ ) | Acceptance (Q'ty) |  | A area | B area | $\Phi \leq 0.10$ | Accept no dense |  | $0.10 < \Phi \leq 0.20$ | 3 | Ignore | $0.20 < \Phi \leq 0.30$ | 2 | Total quantity | 4 |                | Dimension |  | Acceptance (Q'ty) |  | Length (L) | Width (W) | A area | B area | --- | $W \leq 0.03$ | Accept no dense | Ignore | $L \leq 3.0$ | $0.03 < W \leq 0.05$ | 4 | $L \leq 2.5$ | $0.05 < W \leq 0.075$ | --- | $W > 0.075$ | As round type |  | Minor |
| Dimension (diameter : $\Phi$ ) | Acceptance (Q'ty)   |   |                                |                   |  |        |        |                  |                 |  |                         |   |        |                         |   |                |   |                |           |  |                   |  |            |           |        |        |     |               |                 |        |              |                      |   |              |                       |     |             |               |  |       |
|                                | A area  | B area  |                                |                   |  |        |        |                  |                 |  |                         |   |        |                         |   |                |   |                |           |  |                   |  |            |           |        |        |     |               |                 |        |              |                      |   |              |                       |     |             |               |  |       |
| $\Phi \leq 0.10$               | Accept no dense   |   |                                |                   |  |        |        |                  |                 |  |                         |   |        |                         |   |                |   |                |           |  |                   |  |            |           |        |        |     |               |                 |        |              |                      |   |              |                       |     |             |               |  |       |
| $0.10 < \Phi \leq 0.20$        | 3   | Ignore  |                                |                   |  |        |        |                  |                 |  |                         |   |        |                         |   |                |   |                |           |  |                   |  |            |           |        |        |     |               |                 |        |              |                      |   |              |                       |     |             |               |  |       |
| $0.20 < \Phi \leq 0.30$        | 2   |   |                                |                   |  |        |        |                  |                 |  |                         |   |        |                         |   |                |   |                |           |  |                   |  |            |           |        |        |     |               |                 |        |              |                      |   |              |                       |     |             |               |  |       |
| Total quantity                 | 4   |   |                                |                   |  |        |        |                  |                 |  |                         |   |        |                         |   |                |   |                |           |  |                   |  |            |           |        |        |     |               |                 |        |              |                      |   |              |                       |     |             |               |  |       |
| Dimension                      |   | Acceptance (Q'ty)   |                                |                   |  |        |        |                  |                 |  |                         |   |        |                         |   |                |   |                |           |  |                   |  |            |           |        |        |     |               |                 |        |              |                      |   |              |                       |     |             |               |  |       |
| Length (L)                     | Width (W)   | A area  | B area                         |                   |  |        |        |                  |                 |  |                         |   |        |                         |   |                |   |                |           |  |                   |  |            |           |        |        |     |               |                 |        |              |                      |   |              |                       |     |             |               |  |       |
| ---                            | $W \leq 0.03$   | Accept no dense   | Ignore                         |                   |  |        |        |                  |                 |  |                         |   |        |                         |   |                |   |                |           |  |                   |  |            |           |        |        |     |               |                 |        |              |                      |   |              |                       |     |             |               |  |       |
| $L \leq 3.0$                   | $0.03 < W \leq 0.05$  | 4   |                                |                   |  |        |        |                  |                 |  |                         |   |        |                         |   |                |   |                |           |  |                   |  |            |           |        |        |     |               |                 |        |              |                      |   |              |                       |     |             |               |  |       |
| $L \leq 2.5$                   | $0.05 < W \leq 0.075$   |   |                                |                   |  |        |        |                  |                 |  |                         |   |        |                         |   |                |   |                |           |  |                   |  |            |           |        |        |     |               |                 |        |              |                      |   |              |                       |     |             |               |  |       |
| ---                            | $W > 0.075$   | As round type   |                                |                   |  |        |        |                  |                 |  |                         |   |        |                         |   |                |   |                |           |  |                   |  |            |           |        |        |     |               |                 |        |              |                      |   |              |                       |     |             |               |  |       |
| 06                             | <p>Polarizer Bubble</p>   | <table border="1"> <thead> <tr> <th rowspan="2">Dimension (diameter : <math>\Phi</math>)</th> <th colspan="2">Acceptance (Q'ty)</th> </tr> <tr> <th>A area</th> <th>B area</th> </tr> </thead> <tbody> <tr> <td><math>\Phi \leq 0.20</math></td> <td colspan="2">Accept no dense</td> </tr> <tr> <td><math>0.20 &lt; \Phi \leq 0.50</math></td> <td>3</td> <td rowspan="3">Ignore</td> </tr> <tr> <td><math>0.50 &lt; \Phi \leq 1.00</math></td> <td>2</td> </tr> <tr> <td><math>\Phi &gt; 1.00</math></td> <td>0</td> </tr> <tr> <td>Total quantity</td> <td colspan="2">4</td> </tr> </tbody> </table>  | Dimension (diameter : $\Phi$ ) | Acceptance (Q'ty) |  | A area | B area | $\Phi \leq 0.20$ | Accept no dense |  | $0.20 < \Phi \leq 0.50$ | 3 | Ignore | $0.50 < \Phi \leq 1.00$ | 2 | $\Phi > 1.00$  | 0 | Total quantity | 4         |  | Minor             |  |            |           |        |        |     |               |                 |        |              |                      |   |              |                       |     |             |               |  |       |
| Dimension (diameter : $\Phi$ ) | Acceptance (Q'ty)   |   |                                |                   |  |        |        |                  |                 |  |                         |   |        |                         |   |                |   |                |           |  |                   |  |            |           |        |        |     |               |                 |        |              |                      |   |              |                       |     |             |               |  |       |
|                                | A area  | B area  |                                |                   |  |        |        |                  |                 |  |                         |   |        |                         |   |                |   |                |           |  |                   |  |            |           |        |        |     |               |                 |        |              |                      |   |              |                       |     |             |               |  |       |
| $\Phi \leq 0.20$               | Accept no dense   |   |                                |                   |  |        |        |                  |                 |  |                         |   |        |                         |   |                |   |                |           |  |                   |  |            |           |        |        |     |               |                 |        |              |                      |   |              |                       |     |             |               |  |       |
| $0.20 < \Phi \leq 0.50$        | 3   | Ignore  |                                |                   |  |        |        |                  |                 |  |                         |   |        |                         |   |                |   |                |           |  |                   |  |            |           |        |        |     |               |                 |        |              |                      |   |              |                       |     |             |               |  |       |
| $0.50 < \Phi \leq 1.00$        | 2   |   |                                |                   |  |        |        |                  |                 |  |                         |   |        |                         |   |                |   |                |           |  |                   |  |            |           |        |        |     |               |                 |        |              |                      |   |              |                       |     |             |               |  |       |
| $\Phi > 1.00$                  | 0   |   |                                |                   |  |        |        |                  |                 |  |                         |   |        |                         |   |                |   |                |           |  |                   |  |            |           |        |        |     |               |                 |        |              |                      |   |              |                       |     |             |               |  |       |
| Total quantity                 | 4   |   |                                |                   |  |        |        |                  |                 |  |                         |   |        |                         |   |                |   |                |           |  |                   |  |            |           |        |        |     |               |                 |        |              |                      |   |              |                       |     |             |               |  |       |

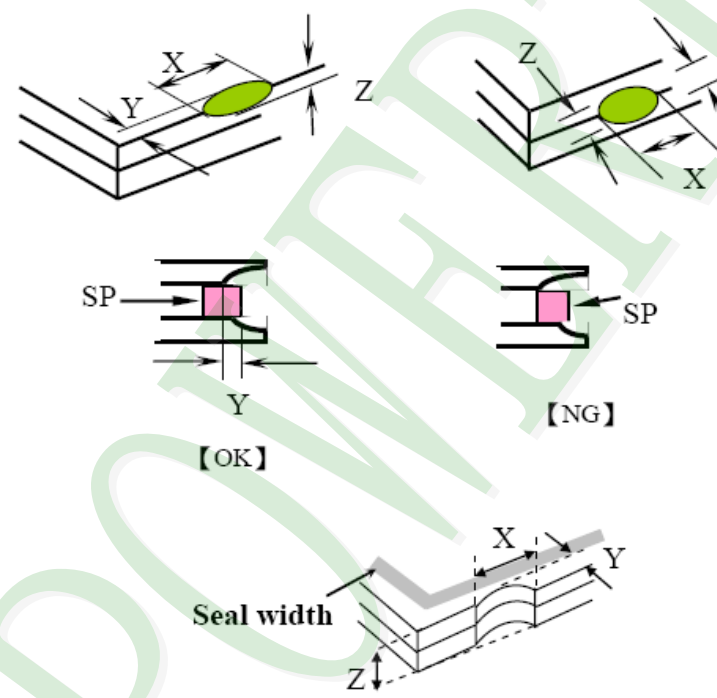

| NO       | Item                                     | Criterion  | Level |   |   |   |          |                                |              |
|----------|--|--|-------|---|---|---|----------|--------------------------------|--------------|
| 07       | The crack of glass                       | <p>Symbols :</p> <p>X : The length of crack                      Y : The width of crack.<br/>                     Z : The thickness of crack                W : terminal length<br/>                     t : The thickness of glass                a : LCD side length</p>   | Minor |   |   |   |          |                                |              |
|          |  | <p>7.1 General glass chip :</p> <p>7.1.1 Chip on panel surface and crack between panels:</p>  <table border="1" data-bbox="502 1489 1300 1780"> <thead> <tr> <th>X</th> <th>Y</th> <th>Z</th> </tr> </thead> <tbody> <tr> <td><math>\leq a</math></td> <td>Crack can't enter viewing area</td> <td><math>\leq 1/2 t</math></td> </tr> <tr> <td><math>\leq a</math></td> <td>Crack can't exceed the half of SP width.</td> <td><math>1/2 t &lt; Z \leq 2 t</math></td> </tr> </tbody> </table> |       | X | Y | Z | $\leq a$ | Crack can't enter viewing area | $\leq 1/2 t$ |
| X        | Y  | Z  |       |   |   |   |          |                                |              |
| $\leq a$ | Crack can't enter viewing area           | $\leq 1/2 t$   |       |   |   |   |          |                                |              |
| $\leq a$ | Crack can't exceed the half of SP width. | $1/2 t < Z \leq 2 t$   |       |   |   |   |          |                                |              |

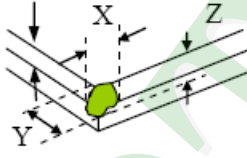
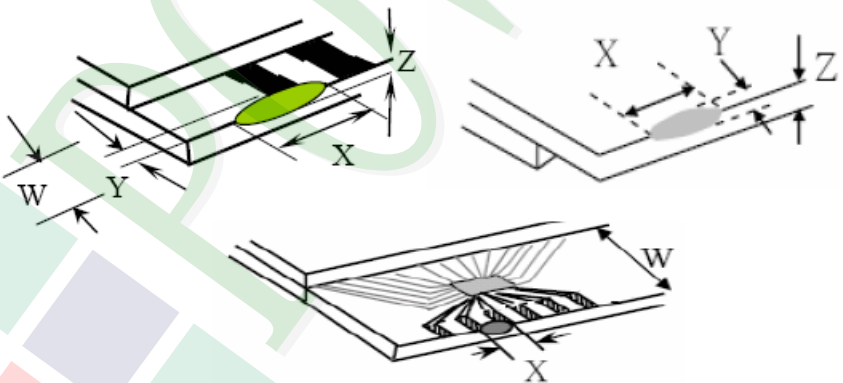
| NO  | Item                                     | Criterion   | Level    |   |       |              |                                |                |              |  |                      |       |
|---|--|---|----------|---|-------|--------------|--------------------------------|----------------|--------------|--|----------------------|-------|
| 07  | The crack of glass                       | <p><b>Symbols :</b></p> <p><b>X :</b> The length of crack<br/> <b>Z :</b> The thickness of crack<br/> <b>t :</b> The thickness of glass</p> <p><b>Y :</b> The width of crack.<br/> <b>W :</b> terminal length<br/> <b>a :</b> LCD side length</p> <hr/> <p>7.1.2 Corner crack :</p>  <table border="1" data-bbox="502 801 1321 1093"> <thead> <tr> <th>X</th> <th>Y</th> <th>Z</th> </tr> </thead> <tbody> <tr> <td><math>\leq 1/5 a</math></td> <td>Crack can't enter viewing area</td> <td><math>Z \leq 1/2 t</math></td> </tr> <tr> <td><math>\leq 1/5 a</math></td> <td>Crack can't exceed the half of SP width.</td> <td><math>1/2 t &lt; Z \leq 2 t</math></td> </tr> </tbody> </table> | X        | Y | Z     | $\leq 1/5 a$ | Crack can't enter viewing area | $Z \leq 1/2 t$ | $\leq 1/5 a$ | Crack can't exceed the half of SP width. | $1/2 t < Z \leq 2 t$ | Minor |
|   |  | X   | Y        | Z |       |              |                                |                |              |  |                      |       |
| $\leq 1/5 a$  | Crack can't enter viewing area           | $Z \leq 1/2 t$  |          |   |       |              |                                |                |              |  |                      |       |
| $\leq 1/5 a$  | Crack can't exceed the half of SP width. | $1/2 t < Z \leq 2 t$  |          |   |       |              |                                |                |              |  |                      |       |
| <p>7.2 Protrusion over terminal :</p> <p>7.2.1 Chip on electrode pad :</p>  <table border="1" data-bbox="470 1675 1257 1854"> <thead> <tr> <th></th> <th>X</th> <th>Y</th> <th>Z</th> </tr> </thead> <tbody> <tr> <td>Front</td> <td><math>\leq a</math></td> <td><math>\leq 1/2 W</math></td> <td><math>\leq t</math></td> </tr> <tr> <td>Back</td> <td colspan="3">Neglect</td> </tr> </tbody> </table> |  | X   | Y        | Z | Front | $\leq a$     | $\leq 1/2 W$                   | $\leq t$       | Back         | Neglect                                  |                      |       |
|   | X  | Y   | Z        |   |       |              |                                |                |              |  |                      |       |
| Front   | $\leq a$                                 | $\leq 1/2 W$  | $\leq t$ |   |       |              |                                |                |              |  |                      |       |
| Back  | Neglect                                  |   |          |   |       |              |                                |                |              |  |                      |       |

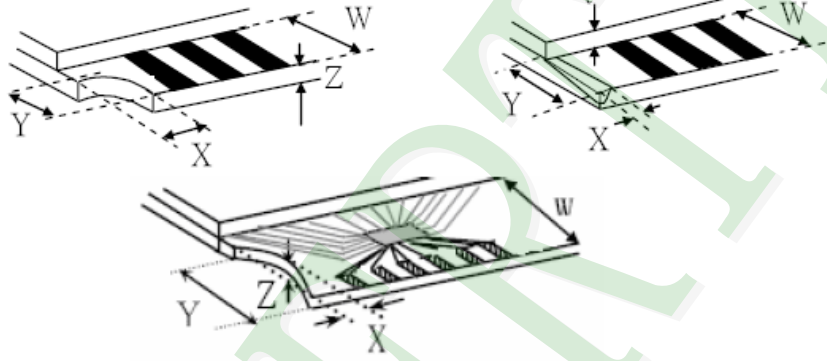
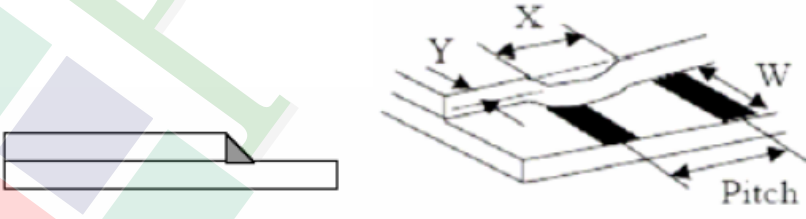
| NO           | Item               | Criterion  | Level |   |   |   |              |          |          |   |   |   |
|--------------|--------------------|--|-------|---|---|---|--------------|----------|----------|---|---|---|
| 07           | The crack of glass | <p>Symbols :</p> <p><b>X</b> : The length of crack<br/> <b>Z</b> : The thickness of crack<br/> <b>t</b> : The thickness of glass</p> <p><b>Y</b> : The width of crack.<br/> <b>W</b> : terminal length<br/> <b>a</b> : LCD side length</p>   | Minor |   |   |   |              |          |          |   |   |   |
|              |                    | <p>7.2.2 Non-conductive portion :</p>  <table border="1" data-bbox="582 1037 1209 1189"> <thead> <tr> <th>X</th> <th>Y</th> <th>Z</th> </tr> </thead> <tbody> <tr> <td><math>\leq 1/3 a</math></td> <td><math>\leq W</math></td> <td><math>\leq t</math></td> </tr> </tbody> </table> <p>⊙ If the chipped area touches the ITO terminal, over 2/3 of the ITO must remain and be inspected according to electrode terminal specifications.</p> <p>7.2.3 Glass remain :</p>  <table border="1" data-bbox="504 1715 1190 1856"> <thead> <tr> <th>X</th> <th>Y</th> <th>Z</th> </tr> </thead> <tbody> <tr> <td><math>\leq a</math></td> <td><math>\leq 1/3 W</math></td> <td><math>\leq t</math></td> </tr> </tbody> </table> |       | X | Y | Z | $\leq 1/3 a$ | $\leq W$ | $\leq t$ | X | Y | Z |
| X            | Y                  | Z  |       |   |   |   |              |          |          |   |   |   |
| $\leq 1/3 a$ | $\leq W$           | $\leq t$   |       |   |   |   |              |          |          |   |   |   |
| X            | Y                  | Z  |       |   |   |   |              |          |          |   |   |   |
| $\leq a$     | $\leq 1/3 W$       | $\leq t$   |       |   |   |   |              |          |          |   |   |   |

**◆ Specification For Monotype and Color STN :**

(Ver. B01)

| NO | Item               | Criterion   | Level |
|----|--------------------|---|-------|
| 08 | Backlight elements | 8. 1 Backlight can't work normally.   | Major |
|    |                    | 8. 2 Backlight doesn't light or color is wrong.                                     | Major |
|    |                    | 8. 3 Illumination source flickers when lit.   | Major |
| 09 | General appearance | 9. 1 Pin type must match type in specification sheet.                               | Major |
|    |                    | 9. 2 No short circuits in components on PCB or FPC.                                 | Major |
|    |                    | 9. 3 Product packaging must the same as specified on packaging specification sheet. | Minor |
|    |                    | 9. 4 The folding and peeled off in polarizer are not acceptable.                    | Minor |
|    |                    | 9. 5 The PCB or FPC between B/L assembled distance (PCB or FPC) is $\leq 1.5$ mm.   | Minor |



## 5. PRECAUTION RELATING PRODUCT HANDLING

### 5.1 SAFETY

- 5.1.1 If the LCD panel breaks , be careful not to get the liquid crystal to touch your skin.
- 5.1.2 If the liquid crystal touches your skin or clothes , please wash it off immediately by using soap and water.

### 5.2 HANDLING

- 5.2.1 Avoid any strong mechanical shock which can break the glass.
- 5.2.2 Avoid static electricity which can damage the CMOS LSI—When working with the module , be sure to ground your body and any electrical equipment you may be using.
- 5.2.3 Do not remove the panel or frame from the module.
- 5.2.4 The polarizing plate of the display is very fragile. So , please handle it very carefully,do not touch , push or rub the exposed polarizing with anything harder than an HB pencil lead (glass , tweezers , etc.)
- 5.2.5 Do not wipe the polarizing plate with a dry cloth , as it may easily scratch the surface of plate.
- 5.2.6 Do not touch the display area with bare hands , this will stain the display area.
- 5.2.7 Do not use ketonics solvent & aromatic solvent. Use with a soft cloth soaked with a cleaning naphtha solvent.
- 5.2.8 To control temperature and time of soldering is  $320 \pm 10^{\circ}\text{C}$  and 3-5 sec.
- 5.2.9 To avoid liquid (include organic solvent) stained on LCM
- 5.2.10 Caution!( LCM products with Capacitive Touch Panel)  
Strong EMI-sources such as switch-mode power supplies (SMPS) can lead to touch malfunction (e.g. ghost-touches).  
Therefore, the touch needs to be thoroughly tested inside the target application.

### 5.3 STORAGE

- 5.3.1 Store the panel or module in a dark place where the temperature is  $25^{\circ}\text{C} \pm 5^{\circ}\text{C}$  and the humidity is below 65% RH.
- 5.3.2 Do not place the module near organics solvents or corrosive gases.
- 5.3.3 Do not crush , shake , or jolt the module.

### 5.4 TERMS OF WARRANTY

- 5.4.1 Applicable warrant period The period is within thirteen months since the date of shipping out under normal using and storage conditions.
- 5.4.2 Unaccepted responsibility  
This product has been manufactured to your company's specification as a part for use in your company's general electronic products. It is guaranteed to perform according to delivery specifications. For any other use apart from general electronic equipment, we cannot take responsibility if the product is used in nuclear power control equipment, aerospace equipment , fire and security systems or any other applications in which there is a direct risk to human life and where extremely high levels of reliability are required.

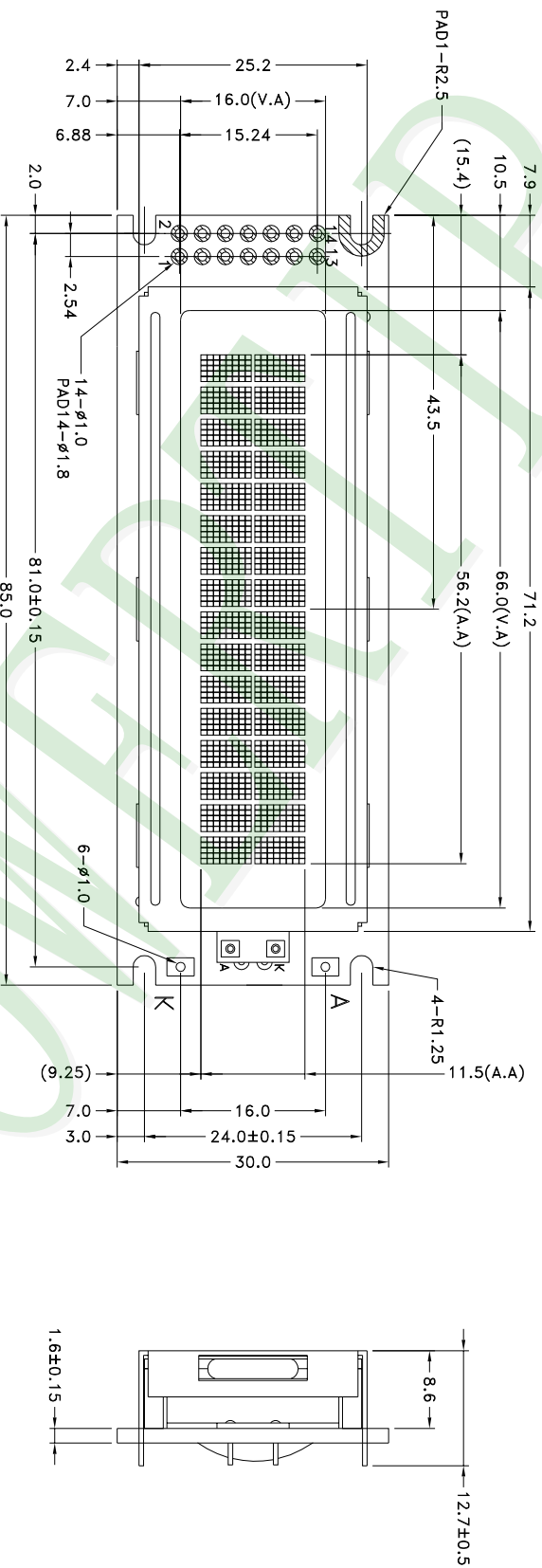

- NOTES:
- 1.LCD TYPE: STN(GRAY) POSITIVE / TRANSLFLECTIVE
  - 3.VIEW DIRECTION: 6 O'CLOCK
  - 4.Top: -20~70°C Tst:-30~80°C
  - 5.This product conforms ROHS
  - 6.The tolerance unless classified ±0.3mm

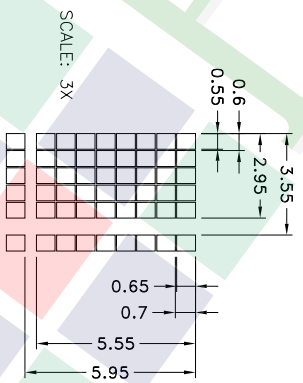

SCALE: 3X

|     |             |               |                       |            |  |         |         |                     |  |                             |      |
|-----|-------------|---------------|-----------------------|------------|--|---------|---------|---------------------|--|-----------------------------|------|
| 007 |             | PART NO:      | NPC1602LRS-JWT-H      |            | <p>久正光电股份有限公司<br/>POWER TIP TECHNOLOGY CORPORATION</p> | Design  | Crystal | Surface<br>Material | 最小长度<br>1 ~ 4<br>4 ~ 16<br>16 ~ 63<br>63 ~ 250<br>250 ~ 1000 | 精度<br>-<br>-<br>-<br>-<br>- |      |
| 006 |             | DRAWING NAME: | JLMD-NPC1602LRS-JWT-H |            |  | Check   | Terry   |                     |  |                             | Unit |
| 005 |             | TITLE:        | LCD Module Drawing    |            |  | Approve | Ryan    | Scale               | 1:1  | Thickness                   |      |
| 004 |             |               |                       |            |  |         |         | Page                | 1/1  | Quantity                    |      |
| 003 |             |               |                       |            |  |         |         |                     |  |                             |      |
| 002 |             |               |                       |            |  |         |         |                     |  |                             |      |
| 001 | NEW DRAWING | REV BY        | Crystal               | 2018/08/22 |  |         |         |                     |  |                             |      |
| REV |             | REVISER       |                       | DATE       |  |         |         |                     |  |                             |      |



|         |                                     |  |         |       |         |
|---------|-------------------------------------|--|---------|-------|---------|
| Ver.001 | Documents NO. JPKG-NPC1602LRS-JWT-H | LCM包裝規格書<br>LCM Packaging Specifications | Approve | Check | Contact |
|         |                                     |  | Ryan    | Terry | Crystal |

1. 包裝材料規格表 (Packaging Material) : (per carton)

| No. | Item                    | Model            | Dimensions (mm)    | 1Pcs Weight | Quantity | Total Weight |
|-----|-------------------------|------------------|--------------------|-------------|----------|--------------|
| 1   | 成品 (LCM)                | NPC1602LRS-JWT-H | 85.0 X 30.0 X 12.7 | 0.0322      | 468      | 15.0696      |
| 2   | 靜電袋(1)Antistatic Bag    | BAG100100ARABA   | 100 X 100          | 0.0011      | 468      | 0.5148       |
| 3   | A1-1隔板(3)A1-1 Partition | BX29500047BZBA   | 295 X 47 X 3       | 0.0078      | 168      | 1.3104       |
| 4   | B1-1隔板(4)B1-1 Partition | BX24500047BZBA   | 245 X 47 X 3       | 0.0065      | 48       | 0.312        |
| 5   | 氣泡紙(5)Bubble Sheet      | BAG280240BWABA   | 280 X 240          | 0.006       | 24       | 0.144        |
| 6   | C1內盒(6)Product Box      | BX31025555AABA   | 310 X 255 X 55     | 0.13        | 12       | 1.56         |
| 7   | 外紙箱(7)Carton            | BX52732536CCBA   | 527 X 325 X 360    | 0.83        | 1        | 0.83         |
| 8   |                         |                  |                    |             |          |              |
| 9   |                         |                  |                    |             |          |              |

2. 一整箱總重量 (Total LCD Weight in carton) : 19.74 Kg±10%  
3. 單箱數量規格表 (Packaging Specifications and Quantity) :  
(1)Quantity Of Spacer : A1-1隔板 X 14 , B1-1隔板 X 4  
(2)Total LCM quantity in carton : quantity per box 39 x no of boxes 12 = 468

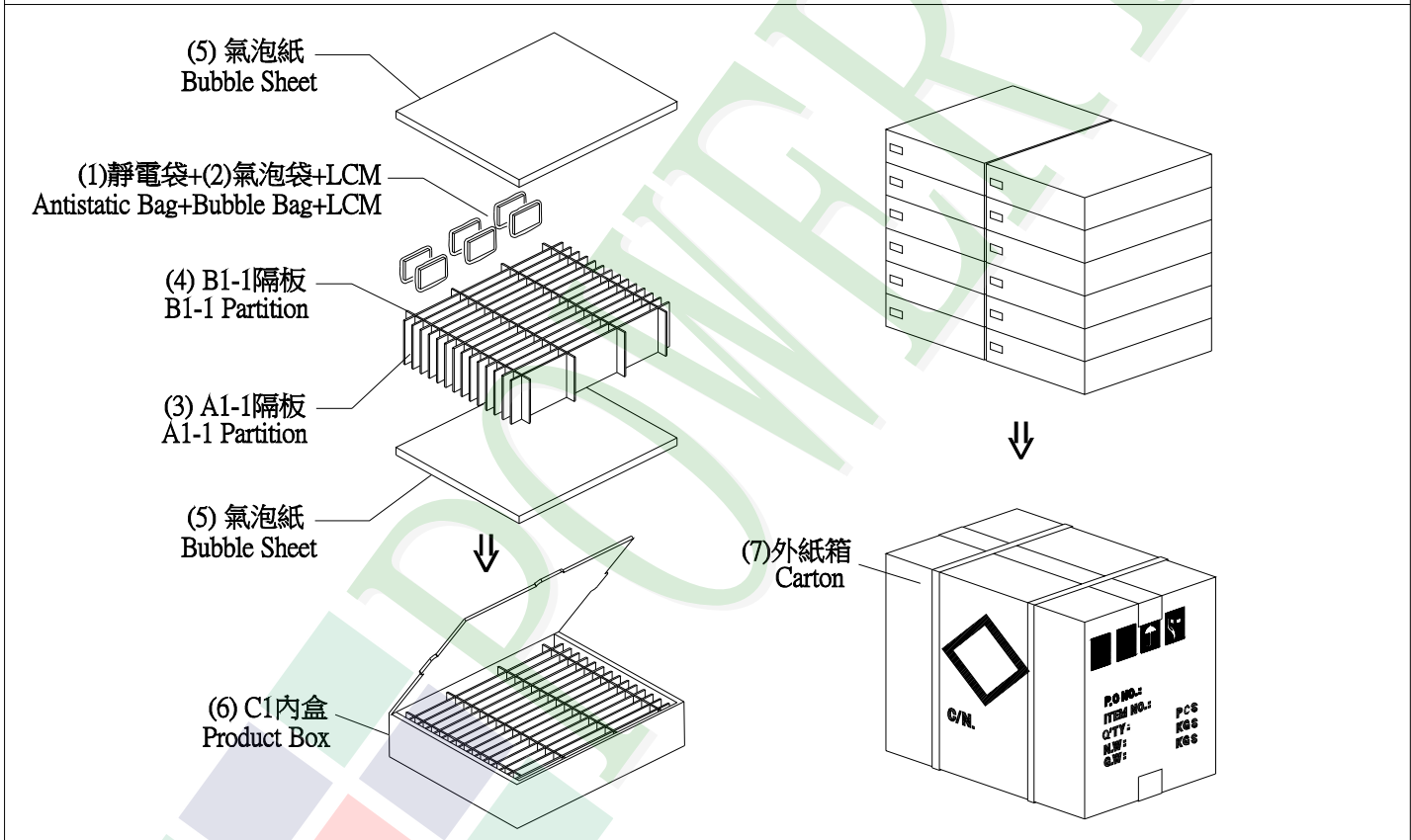

特 記 事 項 (REMARK)

4. Label Specifications :  
依廠內標準作業

5. LCM排放示意圖(前後間隔不放置):  
5. LCM placed as figure showing:  
( First and last slot should be empty)

■ 模組(LCM) X 1pcs.