



SPECIFICATION

OLED SPECIFICATION

Model No:

REC001601AGPP5N00000

CUSTOMER:

APPROVED BY	
PCB VERSION	
DATE	

FOR CUSTOMER USE ONLY

SALES BY	APPROVED BY	CHECKED BY	PREPARED BY

Release DATE:

1. Revision History

VERSION	DATE	REVISED PAGE NO.	Note
0	2011/03/30		First release
A	2011/07/02		Change version
B	2013/09/17		Modify CIE
C	2014/03/21		Update Rev.
D	2014/06/16		Add Low Temperature storage.
E	2015/05/04		Modify Block Diagram
F	2016/06/01		Modify Static electricity test

Contents

- 1.General Specification
- 2.Module Classification Information
- 3.Interface Pin Function
- 4.Contour Drawing & Block Diagram
- 5.Absolute Maximum Ratings
- 6.Electrical Characteristics
- 7.Optical Characteristics
- 8.OLED Lifetime
- 9.Reliability
- 10.Inspection specification
- 11.Precautions in use of OLED Modules

1. General Specification

The Features is described as follow:

- Module dimension: 80.0 x 36.0 x 10.0 (max.) mm
- View area: 66.0 x 16.0 mm
- Active area: 56.95 x 6.35 mm
- Number of Characters :16 Characters x 1 Line
- Dot size: 0.55 x 0.75 mm
- Dot pitch: 0.60x 0.80 mm
- Character size: 2.95 x 6.35 mm
- Character pitch: 3.6 x 6.35 mm
- Duty: 1/8
- Emitting Color: OLED ,Green

2.Module Coding System

1	2	3	4	5	6	7	8	9	10	11	12	13	14
R	E	C	001601	A	G	P	P	5	N	0	0	0	00

1	Brand : Raystar Optronics Inc.			
2	E : OLED			
3	Display Type : C→Character, G→Graphic , T→TAB ,X→COG , H→COG (with Frame)			
4	Number of Characters : 16Characters,01Lines.			
5	Series			
6	Emitting Color	A : Amber	R : Red	C : Full Color
		B : Blue	W : White	
		G : Green	Y : Yellow	
		S : Sky Blue	X : Dual Color	
7	Polarizer	P : With Polarizer; N: Without Polarizer A : Anti-glare Polarizer		
8	Display Mode	P : Passive Matrix ; N : Active Matrix		
9	Driver Voltage	3 : 3.0~3.3V ; 5 : 5.0V		
10	Touch Panel	N : Without touch panel; T: With touch panel		
11	Product type	0 : Standard 1 : Sunlight Readable 2 : Transparent OLED (TOLED) 3 : Flexible OLED (FOLED) 4 : OLED Lighting		
12	Inspection Grade	0 : Standard 2 : B grade C : Automotive grade Y : Consumer grade		
13	Interface	0 : Default ; F : FPC ; H : Hot bar ; D : Demo Kit		
14	Serial No.	Serial number(00~ZZ)		

RAYSTAR OPTRONICS



3.Interface Pin Function

Pin No.	Symbol	Level	Description
1	VSS	0V	Ground
2	VDD	5.0V	Supply Voltage for logic
3	NC	-	No Connection
4	RS	H/L	H: DATA, L: Instruction code
5	R/W	H/L	H: Read(Module→MPU) L: Write(MPU→Module)
6	E	H,H→L	Chip enable signal
7	DB0	H/L	Data bit 0
8	DB1	H/L	Data bit 1
9	DB2	H/L	Data bit 2
10	DB3	H/L	Data bit 3
11	DB4	H/L	Data bit 4
12	DB5	H/L	Data bit 5
13	DB6	H/L	Data bit 6
14	DB7	H/L	Data bit 7
15	NC	-	No Connection
16	NC	-	No Connection

4.Counter Drawing & Block Diagram

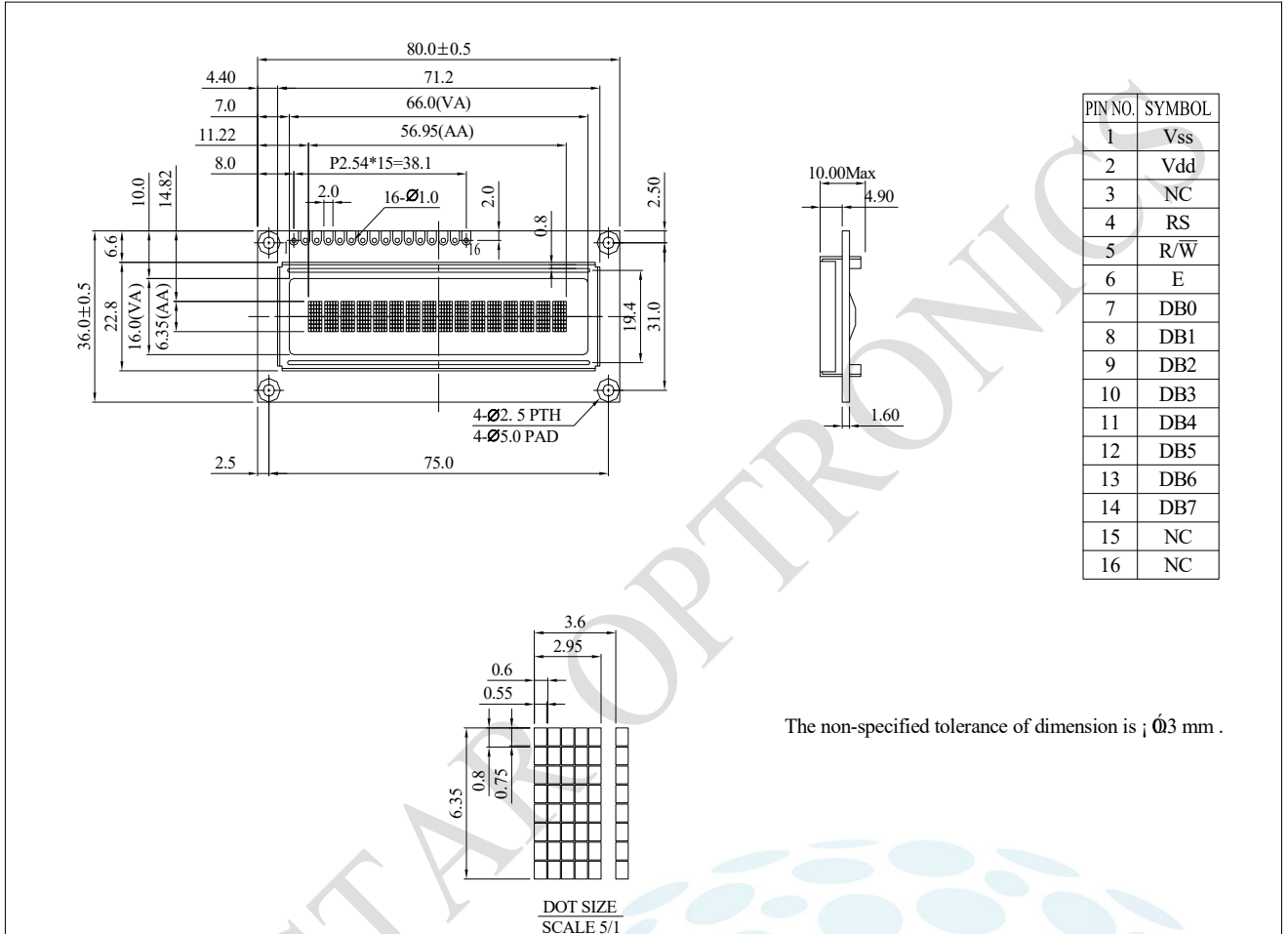

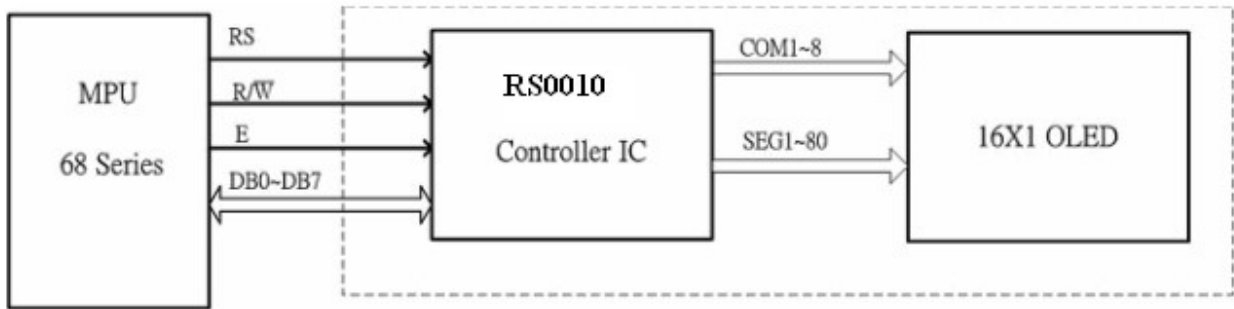

Address Format	DB7	DB6	DB5	DB4	DB3	DB2	DB1	DB0
CA (Character Address)	1	ADD6	ADD5	ADD4	ADD3	ADD2	ADD1	ADD0

1	2	3	4	13	14	15	16
CA=10000000b	CA=10000001b	CA=10000010b	CA=10000011b	CA=10001100b	CA=10001101b	CA=10001110b	CA=10001111b



5. Absolute Maximum Ratings

Item	Symbol	Min	Max	Unit	Notes
Operating Temperature	T _{OP}	-40	+80	°C	
Storage Temperature	T _{ST}	-40	+80	°C	
Supply Voltage For Logic	VDD-V _{SS}	-0.3	5.3	V	

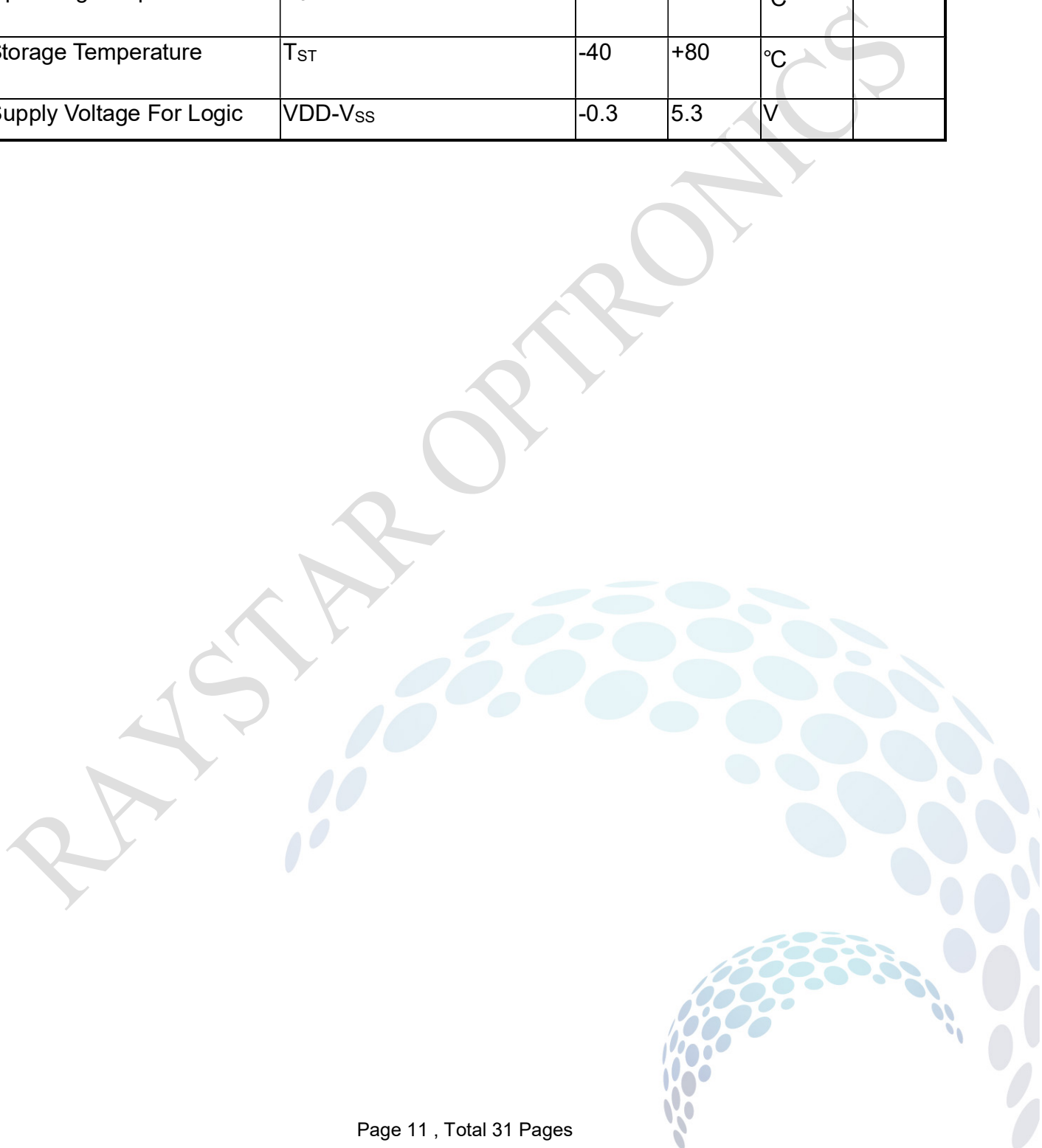

6. Electrical Characteristics

Item	Symbol	Condition	Min	Typ	Max	Unit
Supply Voltage For Logic	VDD-VSS	-	4.8	5.0	5.3	V
Input High Volt.	VIH	-	0.8 VDD	-	VDD	V
Input Low Volt.	VIL	-	GND	-	0.2 VDD	V
Output High Volt.	VOH	IOH=-0.5mA	0.8 VDD	-	VDD	V
Output Low Volt.	VOL	IOL=0.5mA	GND	-	0.2 VDD	V
50% Check Board Operating Current	IDD	VDD=5V	16	18	22	mA

Note: In order to avoid any possible damages, 3V or 3.3V logic I/O for VDD 5V OLED module is not recommended.

7. Optical Characteristics

Item	Symbol	Condition	Min	Typ	Max	Unit
View Angle	(V) θ		160			deg
	(H) ϕ		160			deg
Contrast Ratio	CR	Dark	2000:1		-	-
Response Time	T rise	-		10		μ s
	T fall	-		10		μ s
Display with 50% check Board Brightness			100	120		cd/m ²
CIEx(Green)		(CIE1931)	0.24	0.28	0.32	
CIEy(Green)		(CIE1931)	0.59	0.63	0.67	

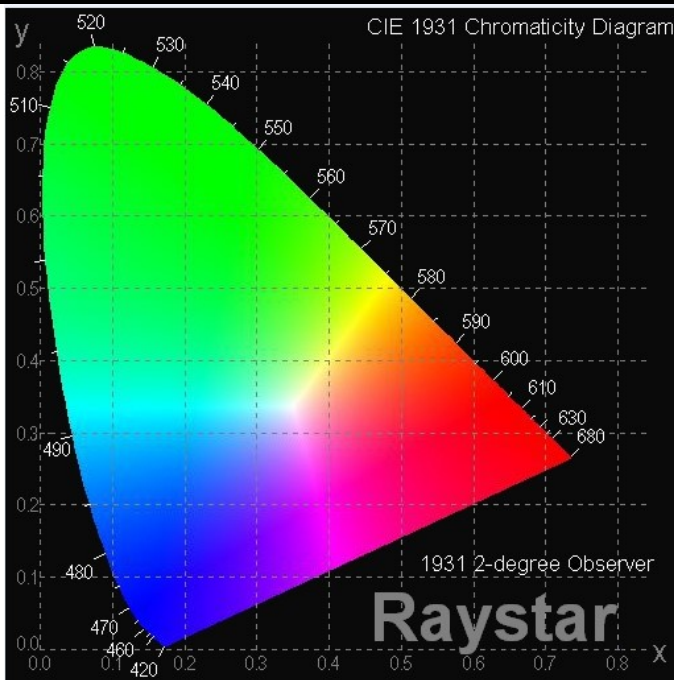



8.OLED Lifetime

ITEM	Conditions	Min	Typ	Remark
Operating Life Time	Ta=25°C / Initial 50% check Board Typical Brightness Value	80,000 Hrs	100,000 Hrs	Note

Note:

1. Life time is defined the amount of time when the luminance has decayed to <50% of the initial value.
2. This analysis method uses life data obtained under accelerated conditions to extrapolate an estimated probability density function (*pdf*) for the product under normal use conditions.
3. Screen saving mode will extend OLED lifetime.

9. Reliability

Content of Reliability Test

Environmental Test			
Test Item	Content of Test	Test Condition	Applicable Standard
High Temperature storage	Endurance test applying the high storage temperature for a long time.	80□ 240hrs	—
Low Temperature storage	Endurance test applying the low storage temperature for a long time.	-40□ 240hrs	—
High Temperature Operation	Endurance test applying the electric stress (Voltage & Current) and the thermal stress to the element for a long time.	80□ 240hrs	—
Low Temperature Operation	Endurance test applying the electric stress under low temperature for a long time.	-40□ 240hrs	—
High Temperature/ Humidity Storage	Endurance test applying the high temperature and high humidity storage for a long time.	60□, 90%RH 240hrs	—
Temperature Cycle	Endurance test applying the low and high temperature cycle. 	-40□/80□ 100 cycles	—
Mechanical Test			
Vibration test	Endurance test applying the vibration during transportation and using.	10~22Hz→1.5mmp-p 22~500Hz→1.5G Total 0.5hr	—
Shock test	Constructional and mechanical endurance test applying the shock during transportation.	50G Half sin wave 11 ms 3 times of each direction	—
Atmospheric pressure test	Endurance test applying the atmospheric pressure during transportation by air.	115mbar 40hrs	—
Others			
Static electricity test	Endurance test applying the electric stress to the terminal.	VS=±600V(contact), ±800v(air), RS=330Ω CS=150pF 10 times	—

*** Supply voltage for OLED system =Operating voltage at 25°C



Test and measurement conditions

1. All measurements shall not be started until the specimens attain to temperature stability. After the completion of the described reliability test, the samples were left at room temperature for 2 hrs prior to conducting the failure test at $23\pm 5^{\circ}\text{C}$; $55\pm 15\%$ RH.
2. All-pixels-on is used as operation test pattern.
3. The degradation of Polarizer are ignored for High Temperature storage, High Temperature/ Humidity Storage, Temperature Cycle

Evaluation criteria

1. The function test is OK.
2. No observable defects.
3. Luminance: $> 50\%$ of initial value.
4. Current consumption: within $\pm 50\%$ of initial value.

APPENDIX:

RESIDUE IMAGE

Because the pixels are lighted in different time, the luminance of active pixels may reduce or differ from inactive pixels. Therefore, the residue image will occur. To avoid the residue image, every pixel needs to be lighted up uniformly.

RAYSTAR OPTROEONICS



10. Inspection specification

NO	Item	Criterion	AQL														
01	Electrical Testing	1.1 Missing vertical, horizontal segment, segment contrast defect. 1.2 Missing character , dot or icon. 1.3 Display malfunction. 1.4 No function or no display. 1.5 Current consumption exceeds product specifications. 1.6 OLED viewing angle defect. 1.7 Mixed product types. 1.8 Contrast defect.	0.65														
02	Black or white spots on OLED (display only)	2.1 White and black spots on display $\square 0.25\text{mm}$, no more than three white or black spots present. 2.2 Densely spaced: No more than two spots or lines within 3mm.	2.5														
03	OLED black spots, white spots, contamination (non-display)	3.1 Round type : As following drawing $\Phi = (x + y) / 2$ <table border="1" data-bbox="826 1081 1294 1395"> <thead> <tr> <th>SIZE</th> <th>Acceptable Q TY</th> </tr> </thead> <tbody> <tr> <td>$\Phi \leq 0.10$</td> <td>Accept no dense</td> </tr> <tr> <td>$0.10 < \Phi \leq 0.20$</td> <td>2</td> </tr> <tr> <td>$0.20 < \Phi \leq 0.25$</td> <td>1</td> </tr> <tr> <td>$0.25 < \Phi$</td> <td>0</td> </tr> </tbody> </table>	SIZE	Acceptable Q TY	$\Phi \leq 0.10$	Accept no dense	$0.10 < \Phi \leq 0.20$	2	$0.20 < \Phi \leq 0.25$	1	$0.25 < \Phi$	0	2.5				
SIZE	Acceptable Q TY																
$\Phi \leq 0.10$	Accept no dense																
$0.10 < \Phi \leq 0.20$	2																
$0.20 < \Phi \leq 0.25$	1																
$0.25 < \Phi$	0																
		3.2 Line type : (As following drawing) <table border="1" data-bbox="635 1435 1294 1693"> <thead> <tr> <th>Length</th> <th>Width</th> <th>Acceptable Q TY</th> </tr> </thead> <tbody> <tr> <td>---</td> <td>$W \leq 0.02$</td> <td>Accept no dense</td> </tr> <tr> <td>$L \leq 3.0$</td> <td>$0.02 < W \leq 0.03$</td> <td rowspan="2">2</td> </tr> <tr> <td>$L \leq 2.5$</td> <td>$0.03 < W \leq 0.05$</td> </tr> <tr> <td>---</td> <td>$0.05 < W$</td> <td>As round type</td> </tr> </tbody> </table>	Length	Width	Acceptable Q TY	---	$W \leq 0.02$	Accept no dense	$L \leq 3.0$	$0.02 < W \leq 0.03$	2	$L \leq 2.5$	$0.03 < W \leq 0.05$	---	$0.05 < W$	As round type	2.5
Length	Width	Acceptable Q TY															
---	$W \leq 0.02$	Accept no dense															
$L \leq 3.0$	$0.02 < W \leq 0.03$	2															
$L \leq 2.5$	$0.03 < W \leq 0.05$																
---	$0.05 < W$	As round type															
04	Polarizer bubbles	If bubbles are visible, judge using black spot specifications, not easy to find, must check in specify direction. <table border="1" data-bbox="778 1733 1294 2024"> <thead> <tr> <th>Size Φ</th> <th>Acceptable Q TY</th> </tr> </thead> <tbody> <tr> <td>$\Phi \leq 0.20$</td> <td>Accept no dense</td> </tr> <tr> <td>$0.20 < \Phi \leq 0.50$</td> <td>3</td> </tr> <tr> <td>$0.50 < \Phi \leq 1.00$</td> <td>2</td> </tr> <tr> <td>$1.00 < \Phi$</td> <td>0</td> </tr> <tr> <td>Total Q TY</td> <td>3</td> </tr> </tbody> </table>	Size Φ	Acceptable Q TY	$\Phi \leq 0.20$	Accept no dense	$0.20 < \Phi \leq 0.50$	3	$0.50 < \Phi \leq 1.00$	2	$1.00 < \Phi$	0	Total Q TY	3	2.5		
Size Φ	Acceptable Q TY																
$\Phi \leq 0.20$	Accept no dense																
$0.20 < \Phi \leq 0.50$	3																
$0.50 < \Phi \leq 1.00$	2																
$1.00 < \Phi$	0																
Total Q TY	3																

NO	Item	Criterion	AQL																		
05	Scratches	Follow NO.3 OLED black spots, white spots, contamination																			
06	Chipped glass	<p>Symbols Define: x: Chip length y: Chip width z: Chip thickness k: Seal width t: Glass thickness a: OLED side length L: Electrode pad length:</p> <p>6.1 General glass chip : 6.1.1 Chip on panel surface and crack between panels:</p> <table border="1"> <thead> <tr> <th>z: Chip thickness</th> <th>y: Chip width</th> <th>x: Chip length</th> </tr> </thead> <tbody> <tr> <td>$Z \leq 1/2t$</td> <td>Not over viewing area</td> <td>$x \leq 1/8a$</td> </tr> <tr> <td>$1/2t < z \leq 2t$</td> <td>Not exceed 1/3k</td> <td>$x \leq 1/8a$</td> </tr> </tbody> </table> <p>⊙ If there are 2 or more chips, x is total length of each chip.</p> <p>6.1.2 Corner crack:</p> <table border="1"> <thead> <tr> <th>z: Chip thickness</th> <th>y: Chip width</th> <th>x: Chip length</th> </tr> </thead> <tbody> <tr> <td>$Z \leq 1/2t$</td> <td>Not over viewing area</td> <td>$x \leq 1/8a$</td> </tr> <tr> <td>$1/2t < z \leq 2t$</td> <td>Not exceed 1/3k</td> <td>$x \leq 1/8a$</td> </tr> </tbody> </table> <p>⊙ If there are 2 or more chips, x is the total length of each chip.</p>	z: Chip thickness	y: Chip width	x: Chip length	$Z \leq 1/2t$	Not over viewing area	$x \leq 1/8a$	$1/2t < z \leq 2t$	Not exceed 1/3k	$x \leq 1/8a$	z: Chip thickness	y: Chip width	x: Chip length	$Z \leq 1/2t$	Not over viewing area	$x \leq 1/8a$	$1/2t < z \leq 2t$	Not exceed 1/3k	$x \leq 1/8a$	2.5
z: Chip thickness	y: Chip width	x: Chip length																			
$Z \leq 1/2t$	Not over viewing area	$x \leq 1/8a$																			
$1/2t < z \leq 2t$	Not exceed 1/3k	$x \leq 1/8a$																			
z: Chip thickness	y: Chip width	x: Chip length																			
$Z \leq 1/2t$	Not over viewing area	$x \leq 1/8a$																			
$1/2t < z \leq 2t$	Not exceed 1/3k	$x \leq 1/8a$																			

RAYSTAR OPTRONICS





NO	Item	Criterion	AQL																
06	Glass crack	<p>Symbols : x: Chip length y: Chip width z: Chip thickness k: Seal width t: Glass thickness a: OLED side length L: Electrode pad length</p> <p>6.2 Protrusion over terminal : 6.2.1 Chip on electrode pad :</p> <table border="1" data-bbox="331 898 1217 987"> <tr> <td>y: Chip width</td> <td>x: Chip length</td> <td>z: Chip thickness</td> </tr> <tr> <td>$y \leq 0.5\text{mm}$</td> <td>$x \leq 1/8a$</td> <td>$0 < z \leq t$</td> </tr> </table> <p>6.2.2 Non-conductive portion:</p> <table border="1" data-bbox="400 1308 1217 1435"> <tr> <td>y: Chip width</td> <td>x: Chip length</td> <td>z: Chip thickness</td> </tr> <tr> <td>$y \leq L$</td> <td>$x \leq 1/8a$</td> <td>$0 < z \leq t$</td> </tr> </table> <p>⊙If the chipped area touches the ITO terminal, over 2/3 of the ITO must remain and be inspected according to electrode terminal specifications. ⊙If the product will be heat sealed by the customer, the alignment mark not be damaged.</p> <p>6.2.3 Substrate protuberance and internal crack.</p> <table border="1" data-bbox="730 1704 1222 1794"> <tr> <td>y: width</td> <td>x: length</td> </tr> <tr> <td>$y \leq 1/3L$</td> <td>$x \leq a$</td> </tr> </table>	y: Chip width	x: Chip length	z: Chip thickness	$y \leq 0.5\text{mm}$	$x \leq 1/8a$	$0 < z \leq t$	y: Chip width	x: Chip length	z: Chip thickness	$y \leq L$	$x \leq 1/8a$	$0 < z \leq t$	y: width	x: length	$y \leq 1/3L$	$x \leq a$	2.5
		y: Chip width	x: Chip length	z: Chip thickness															
$y \leq 0.5\text{mm}$	$x \leq 1/8a$	$0 < z \leq t$																	
y: Chip width	x: Chip length	z: Chip thickness																	
$y \leq L$	$x \leq 1/8a$	$0 < z \leq t$																	
y: width	x: length																		
$y \leq 1/3L$	$x \leq a$																		

RAYSTAR OPTRONICS



NO	Item	Criterion	AQL
07	Cracked glass	The OLED with extensive crack is not acceptable.	2.5
08	Backlight elements	8.1 Illumination source flickers when lit. 8.2 Spots or scratched that appear when lit must be judged. Using OLED spot, lines and contamination standards. 8.3 Backlight doesn't light or color wrong.	0.65 2.5 0.65
09	Bezel	9.1 Bezel may not have rust, be deformed or have fingerprints, stains or other contamination. 9.2 Bezel must comply with job specifications.	2.5 0.65
10	PCB, COB	10.1 COB seal may not have pinholes larger than 0.2mm or contamination. 10.2 COB seal surface may not have pinholes through to the IC. 10.3 The height of the COB should not exceed the height indicated in the assembly diagram. 10.4 There may not be more than 2mm of sealant outside the seal area on the PCB. And there should be no more than three places. 10.5 No oxidation or contamination PCB terminals. 10.6 Parts on PCB must be the same as on the production characteristic chart. There should be no wrong parts, missing parts or excess parts. 10.7 The jumper on the PCB should conform to the product characteristic chart. 10.8 If solder gets on bezel tab pads, OLED pad, zebra pad or screw hold pad, make sure it is smoothed down.	2.5 2.5 0.65 2.5 2.5 0.65 0.65 2.5
11	Soldering	11.1 No un-melted solder paste may be present on the PCB. 11.2 No cold solder joints, missing solder connections, oxidation or icicle. 11.3 No residue or solder balls on PCB. 11.4 No short circuits in components on PCB.	2.5 2.5 2.5 0.65

NO	Item	Criterion	AQL
12	General appearance	12.1 No oxidation, contamination, curves or, bends on interface Pin (OLB) of TCP.	2.5
		12.2 No cracks on interface pin (OLB) of TCP.	0.65
		12.3 No contamination, solder residue or solder balls on product.	2.5
		12.4 The IC on the TCP may not be damaged, circuits.	2.5
		12.5 The uppermost edge of the protective strip on the interface pin must be present or look as if it cause the interface pin to sever.	2.5
		12.6 The residual rosin or tin oil of soldering (component or chip component) is not burned into brown or black color.	2.5
		12.7 Sealant on top of the ITO circuit has not hardened.	0.65
		12.8 Pin type must match type in specification sheet.	0.65
		12.9 OLED pin loose or missing pins.	0.65
		12.10 Product packaging must the same as specified on packaging specification sheet.	0.65
		12.11 Product dimension and structure must conform to product specification sheet.	0.65

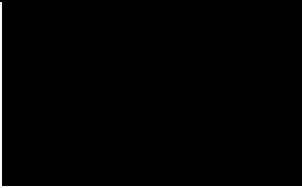
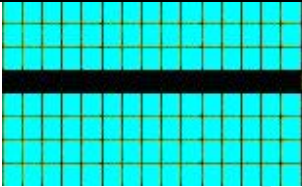
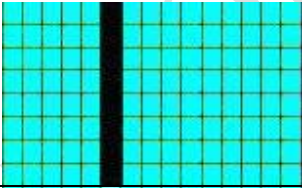
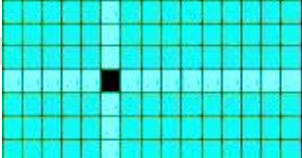
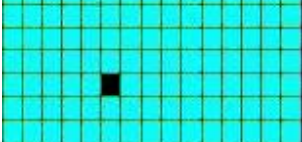
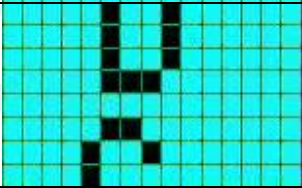
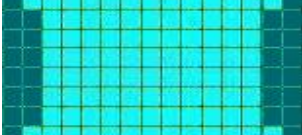
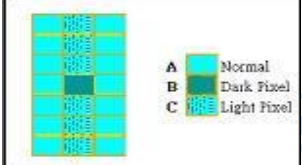
Check Item	Classification	Criteria
No Display	Major	
Missing Line	Major	 
Pixel Short	Major	
Darker Short	Major	
Wrong Display	Major	
Un-uniform B/A x 100% < 70% A/C x 100% < 70%	Major	 



11. Precautions in use of OLED Modules

- (1) Avoid applying excessive shocks to module or making any alterations or modifications to it.
- (2) Don't make extra holes on the printed circuit board, modify its shape or change the components of OLED display module.
- (3) Don't disassemble the OLED display module.
- (4) Don't operate it above the absolute maximum rating.
- (5) Don't drop, bend or twist OLED display module.
- (6) Soldering: only to the I/O terminals.
- (7) Storage: please storage in anti-static electricity container and clean environment.
- (8) It's pretty common to use "Screen Saver" to extend the lifetime and Don't use fix information for long time in real application.
- (9) Don't use fixed information in OLED panel for long time, that will extend "screen burn" effect time..
- (10) Raystar has the right to change the passive components, including R2 and R3 adjust resistors. (Resistors, capacitors and other passive components will have different appearance and color caused by the different supplier.)
- (11) Raystar have the right to change the PCB Rev. (In order to satisfy the supplying stability, management optimization and the best product performance...etc, under the premise of not affecting the electrical characteristics and external dimensions, Raystar have the right to modify the version.)

11.1 Handling Precautions

- (1) Since the display panel is being made of glass, do not apply mechanical impacts such as dropping from a high position.
- (2) If the display panel is broken by some accident and the internal organic substance leaks out, be careful not to inhale nor lick the organic substance.
- (3) If pressure is applied to the display surface or its neighborhood of the OLED display module, the cell structure may be damaged and be careful not to apply pressure to these sections.
- (4) The polarizer covering the surface of the OLED display module is soft and easily scratched. Please be careful when handling the OLED display module.
- (5) When the surface of the polarizer of the OLED display module has soil, clean the surface. It takes advantage of by using following adhesion tape.

* Scotch Mending Tape No. 810 or an equivalent

Never try to breathe upon the soiled surface nor wipe the surface using cloth containing solvent Also, pay attention that the following liquid and solvent may spoil the polarizer:

* Water

* Ketone

* Aromatic Solvents

- (6) Hold OLED display module very carefully when placing OLED display module into the System housing. Do not apply excessive stress or pressure to OLED display module. And, do not over bend the film with electrode pattern layouts. These stresses will influence the display performance. Also, secure sufficient rigidity for the outer cases.



- (7) Do not apply stress to the LSI chips and the surrounding molded sections.
- (8) Do not disassemble nor modify the OLED display module.
- (9) Do not apply input signals while the logic power is off.
- (10) Pay sufficient attention to the working environments when handing OLED display modules to prevent occurrence of element breakage accidents by static electricity.
 - * Be sure to make human body grounding when handling OLED display modules.
 - * Be sure to ground tools to use or assembly such as soldering irons.
 - * To suppress generation of static electricity, avoid carrying out assembly work under dry environments.
 - * Protective film is being applied to the surface of the display panel of the OLED display module. Be careful since static electricity may be generated when exfoliating the protective film.
- (11) Protection film is being applied to the surface of the display panel and removes the protection film before assembling it. At this time, if the OLED display module has been stored surface of the display panel after removed of the film. In such case, remove the residue material by the method introduced in the above Section 5.
- (12) If electric current is applied when the OLED display module is being dewed or when it is placed under high humidity environments, the electrodes may be corroded and be careful to avoid the above.

11.2 Storage Precautions

- (1) When storing OLED display modules, put them in static electricity preventive bags avoiding exposure to direct sun light nor to lights of fluorescent lamps. And, also, avoiding high temperature and high humidity environment or low temperature (less than 0°C) environments. (We recommend you to store these modules in the packaged state when they were shipped from Raystar Optronics Inc. At that time, be careful not to let water drops adhere to the packages or bags nor let dewing occur with them.
- (2) If electric current is applied when water drops are adhering to the surface of the OLED display module, when the OLED display module is being dewed or when it is placed under high humidity environments, the electrodes may be corroded and be careful about the above.



11.3 Designing Precautions

- (1) The absolute maximum ratings are the ratings which cannot be exceeded for OLED display module, and if these values are exceeded, panel damage may be happen.
- (2) To prevent occurrence of malfunctioning by noise, pay attention to satisfy the VIL and VIH specifications and, at the same time, to make the signal line cable as short as possible.
- (3) We recommend you to install excess current preventive unit (fuses, etc.) to the power circuit (VDD). (Recommend value: 0.5A)
- (4) Pay sufficient attention to avoid occurrence of mutual noise interference with the neighboring devices.
- (5) As for EMI, take necessary measures on the equipment side basically.
- (6) When fastening the OLED display module, fasten the external plastic housing section.
- (7) If power supply to the OLED display module is forcibly shut down by such errors as taking out the main battery while the OLED display panel is in operation, we cannot guarantee the quality of this OLED display module. Connection (contact) to any other potential than the above may lead to rupture of the IC.

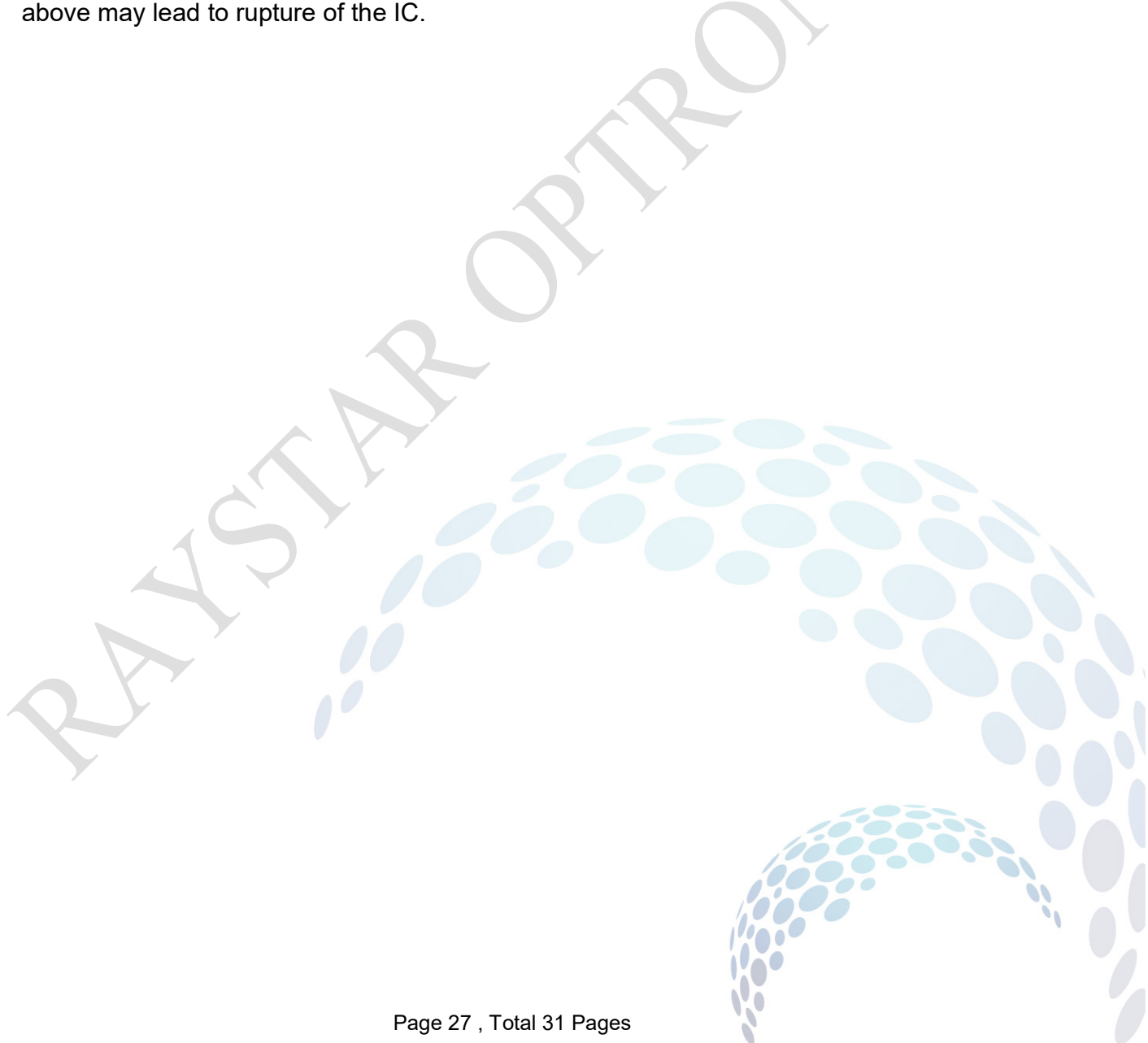

Module Sample Estimate Feedback Sheet

Module Number : _____

1. Panel Specification :

1. Panel Type :	<input type="checkbox"/> Pass	<input type="checkbox"/> NG , _____
2. Numbers of Pixel :	<input type="checkbox"/> Pass	<input type="checkbox"/> NG , _____
3. View Area :	<input type="checkbox"/> Pass	<input type="checkbox"/> NG , _____
4. Active Area :	<input type="checkbox"/> Pass	<input type="checkbox"/> NG , _____
5. Emitting Color :	<input type="checkbox"/> Pass	<input type="checkbox"/> NG , _____
6. Uniformity :	<input type="checkbox"/> Pass	<input type="checkbox"/> NG , _____
7. Operating Temperature :	<input type="checkbox"/> Pass	<input type="checkbox"/> NG , _____
8. Storage Temperature :	<input type="checkbox"/> Pass	<input type="checkbox"/> NG , _____
9. Others : _____		

2. Mechanical Specification :

1. PCB Size :	<input type="checkbox"/> Pass	<input type="checkbox"/> NG , _____
2. Frame Size :	<input type="checkbox"/> Pass	<input type="checkbox"/> NG , _____
3. Material of Frame :	<input type="checkbox"/> Pass	<input type="checkbox"/> NG , _____
4. Connector Position :	<input type="checkbox"/> Pass	<input type="checkbox"/> NG , _____
5. Fix Hole Position :	<input type="checkbox"/> Pass	<input type="checkbox"/> NG , _____
6. Thickness of PCB :	<input type="checkbox"/> Pass	<input type="checkbox"/> NG , _____
7. Height of Frame to PCB :	<input type="checkbox"/> Pass	<input type="checkbox"/> NG , _____
8. Height of Module :	<input type="checkbox"/> Pass	<input type="checkbox"/> NG , _____
9. Others :	<input type="checkbox"/> Pass	<input type="checkbox"/> NG , _____

3. Relative Hole Size :

1. Pitch of Connector :	<input type="checkbox"/> Pass	<input type="checkbox"/> NG , _____
2. Hole size of Connector :	<input type="checkbox"/> Pass	<input type="checkbox"/> NG , _____
3. Mounting Hole size :	<input type="checkbox"/> Pass	<input type="checkbox"/> NG , _____
4. Mounting Hole Type :	<input type="checkbox"/> Pass	<input type="checkbox"/> NG , _____



RAYSTAR

5.Others :	<input type="checkbox"/> Pass	<input type="checkbox"/> NG , _____
------------	-------------------------------	-------------------------------------

> > Go to page 2 < <

RAYSTAR OPTRONICS





Module Number : _____

4、 Electronic Characteristics of Module :

1.Input Voltage :	<input type="checkbox"/> Pass	<input type="checkbox"/> NG , _____
2.Supply Current :	<input type="checkbox"/> Pass	<input type="checkbox"/> NG , _____
3.Driving Voltage for OLED :	<input type="checkbox"/> Pass	<input type="checkbox"/> NG , _____
4.Contrast for OLED :	<input type="checkbox"/> Pass	<input type="checkbox"/> NG , _____
5.Negative Voltage Output :	<input type="checkbox"/> Pass	<input type="checkbox"/> NG , _____
6.Interface Function :	<input type="checkbox"/> Pass	<input type="checkbox"/> NG , _____
7.ESD test :	<input type="checkbox"/> Pass	<input type="checkbox"/> NG , _____
8.Others :	<input type="checkbox"/> Pass	<input type="checkbox"/> NG , _____

5、 Summary :

Sales signature : _____

Customer Signature : _____

Date : ____ / ____ / ____

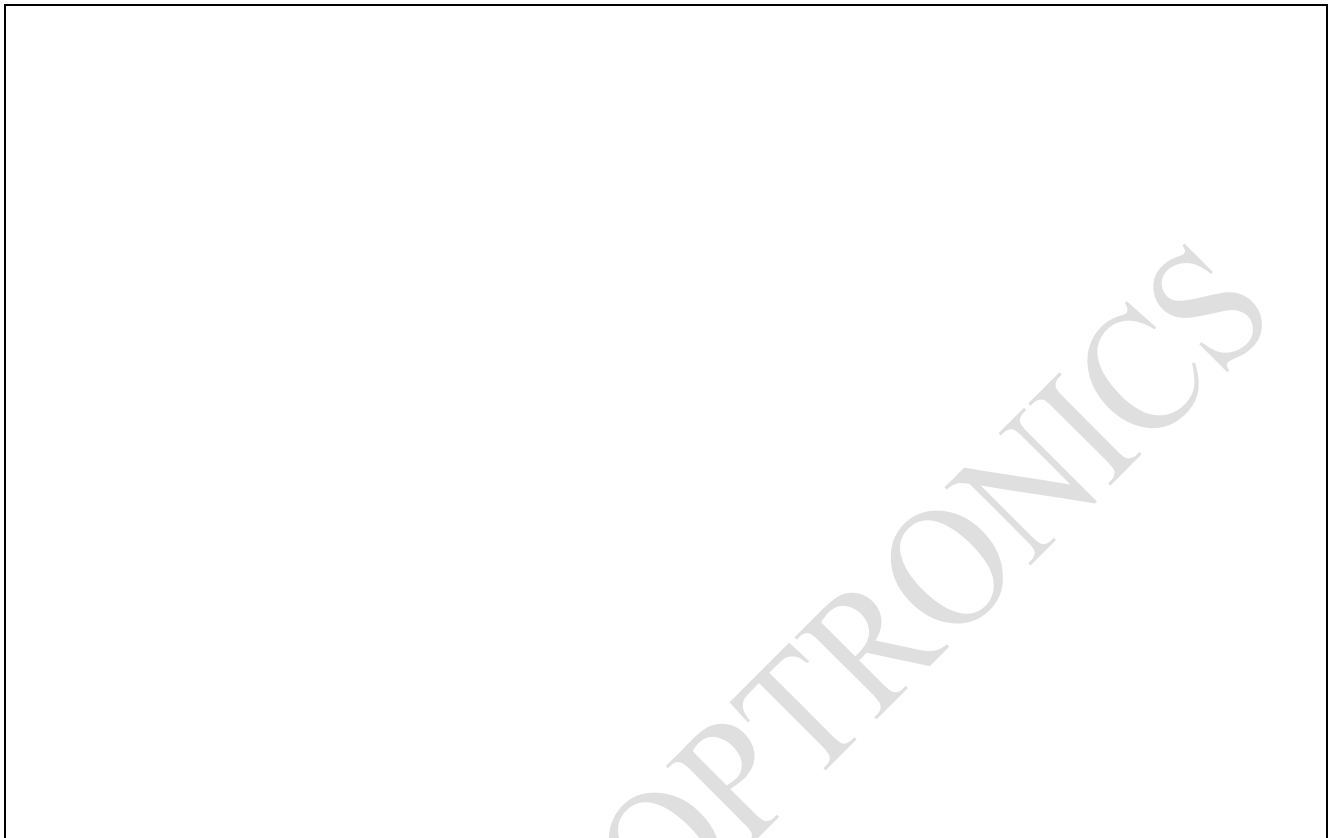

RAYSTAR OPTRONICS

