

Controls – Soft Starters and Solid-State Switching Devices

4



	Price Groups PG 101, 131, 191		
4/2	Introduction		
4/5	SIRIUS 3RW Soft Starters General data <u>3RW30, 3RW40</u> for Standard Applications	4/103	Solid-State Switching Devices for Switching Motors ^{neu} <u>Solid-State Contactors</u> General data
4/8	3RW30	4/106	SIRIUS 3RF34 solid-state contactors, three-phase
4/18	3RW40 <u>3RW44</u> for High-Feature Applications	4/109	SIRIUS 3RF34 solid-state reversing contactors, three-phase
4/34	3RW44		
	Solid-State Switching Devices for Resistive Loads		More technical information can be found at www.siemens.com/industrial- controls/support under Product List: - Technical specifications under Entry List: - Updates - Downloads - FAQ - Manuals - Characteristics - Certificates and at www.siemens.com/industrial- controls/configurators - Configurators
4/62	General data <u>Solid-State Relays</u>		
4/65	General data		
4/66	SIRIUS 3RF21 solid-state relays, single-phase, 22.5 mm		
4/71	SIRIUS 3RF20 solid-state relays, single-phase, 45 mm		
4/74	SIRIUS 3RF22 solid-state relays, three-phase, 45 mm		
	<u>Solid-State Contactors</u>		
4/77	General data		
4/78	SIRIUS 3RF23 solid-state contactors, single-phase		
4/87	SIRIUS 3RF24 solid-state contactors, three-phase <u>3RF2 Function Modules</u>		<i>Note:</i> <i>The 3RF24 solid-state contactors for switching motors can be found</i> <i>- In the catalog Add-On LV 1 AO · 2011 in the CD/DVD box</i> <i>- In the catalog Add-On LV 1 AO · 2011 at the Information and Download Center</i> <i>- In the interactive catalog CA 01</i> <i>- In the Industry Mall</i>
4/91	General data		
4/98	SIRIUS converters for 3RF2		
4/99	SIRIUS load monitoring for 3RF2		
4/100	SIRIUS heating current monitoring for 3RF2		
4/101	SIRIUS power controllers for 3RF2		
4/102	SIRIUS power regulators for 3RF2		

Introduction

Overview



3RW30



3RW40



3RW44

3RW soft starters

3RW soft starters for Standard applications

3RW30 soft starters

- SIRIUS 3RW30 soft starters for soft starting of three-phase asynchronous motors
- Performance range of up to 55 kW (at 400 V)

Order No.

Page

3RW30

4/8

3RW40 soft starters

- SIRIUS 3RW40 soft starters with the integral functions
 - Solid-state motor overload and intrinsic device protection and
 - Adjustable current limiting
 for the soft starting and stopping of three-phase asynchronous motors
- Performance range of up to 250 kW (at 400 V)

3RW40

4/18

3RW soft starters for High-Feature applications

3RW44 soft starters

- In addition to soft starting and soft ramp-down, the SIRIUS 3RW44 solid-state soft starters provide numerous functions for higher-level requirements
- Performance range
 - Up to 710 kW (at 400 V) in inline circuit and
 - Up to 1200 kW (at 400 V) in inside-delta circuit

3RW44

4/34

SIRIUS 3RW soft starters

SIRIUS 3RW soft starters permit soft starting and smooth ramp-down of three-phase asynchronous motors. Depending on the scope of functions required it is possible to choose between:

- Soft starters for Standard applications
- Soft starters for High-Feature applications

SIRIUS 3RW – Service-proven in many applications

Functions of the SIRIUS soft starters include:

- Soft starting and smooth ramp-down
- Stepless starting
- Torque control and limitation

Cost-efficient operation

The advantages of SIRIUS soft starters at a glance:

- Reduction of current peaks
- Avoidance of mains voltage fluctuations during starting
- Reduced load on the power supply network
- Reduction of the mechanical load in the operating mechanism
- Considerable space savings and reduced wiring compared with conventional starters
- Maintenance-free switching
- Very easy handling
- Fits perfectly in the SIRIUS modular system



3RF21

3RF20

3RF22

3RF23

3RF24

3RF29

3RF34 (motor)

Order No.

Page

SIRIUS solid-state switching devices for switching resistive loads

Solid-state relays

Solid-state relays

- Widths of 22.5 mm and 45 mm
- Compact and space-saving design
- "Zero-point switching" version
- Mounting onto existing heat sinks

3RF21
3RF20
3RF224/66
4/71
4/74

Solid-state contactors

Solid-state contactors

- Complete units comprising a solid-state relay and an optimized heat sink, "ready to use"
- Compact and space-saving design
- Versions for resistive loads "zero-point switching" and inductive loads "instantaneous switching"
- Special versions "Low Noise" and "Short-Circuit Proof"

3RF23
3RF244/78
4/87

Function modules

For extending the functionality of the 3RF21 solid-state relays and the 3RF23 solid-state contactors for many different applications:

Converters

- For converting an analog input signal into an on/off ratio; can also be used on 3RF22 and 3RF24 three-phase switching devices

3RF29 00-0EA18

4/98

Load monitoring

- For load monitoring of one or more loads (partial loads)

3RF29 ...-0FA08,
3RF29 ...-0GA..

4/99

Heating current monitoring

- For load monitoring of one or more loads (partial loads); remote teach

3RF29 ...-0JA..

4/100

Power controllers

- For supplying the current by means of a solid-state switching device depending on a setpoint value. There is a choice of full-wave control and generalized phase control.

3RF29 ...-0KA..

4/101

Power regulators

- For supplying the current by means of a solid-state switching device depending on a setpoint value. Closed-loop control: full-wave control or generalized phase control

3RF29 ...-0HA..

4/102

SIRIUS solid-state switching devices for switching motors

Solid-state contactors

Solid-state contactors, solid-state reversing contactors

- Complete units in the insulated enclosure with integrated heat sink, "ready to use"
- Compact and space-saving design
- Version for motors, "instantaneous switching"

3RF34
3RF344/106
4/109

Controls – Soft Starters and Solid-State Switching Devices

Introduction

SIRIUS 3RF solid-state switching devices



Three-phase solid-state contactor and single-phase solid-state relay

The SIRIUS 3RF solid-state switching devices reliably switch a wide range of different loads with alternating voltages in 50 and 60 Hz systems.

3RF2 solid-state switching devices for resistive loads

- Solid-state relays
- Solid-state contactors
- Function modules

3RF3 solid-state switching devices for switching motors

- Solid-state contactors
- Solid-state reversing contactors

SIRIUS 3RF2 – for almost unending activity

Conventional electromechanical controlgear is often overtaxed by the rise in the number of switching operations. A high switching frequency results in frequent failure and short replacement cycles. However, this does not have to be the case, because with the latest generation of our SIRIUS 3RF2 solid-state switching devices we provide you with solid-state relays and contactors with a particularly long endurance – for almost unending activity even under the toughest conditions and under high mechanical load, but also in noise-sensitive areas.

Proved time and again in service

SIRIUS 3RF2 solid-state switching devices have firmly established in industrial applications. They are used above all in applications where loads are switched frequently – mainly with resistive load controllers, with the control of electrical heat or the control of valves and motors in conveyor systems. In addition to its use in areas with high switching frequencies, their silent switching means that SIRIUS is also ideally suited for use in noise-sensitive areas, such as offices or hospitals.

The most reliable solution for any application

Compared to mechanical controlgear, our SIRIUS 3RF2 solid-state switching devices stand out due to their considerably longer service life. Thanks to the high product quality, their switching is extremely precise, reliable and, above all, unsusceptible to faults. With its variable connection methods and a wide spread of control voltages, the SIRIUS 3RF2 family is universally applicable. Depending on the individual requirements of the application, our modular controlgear can also be quite easily expanded by the addition of standardized function modules.

Ideal for operation with heating control systems

The 3RF2 solid-state switching devices can be used for example in the SIPLUS HCS300I heating control system. They are optimally connected to the digital output module of the HCS300I by means of preassembled cables. This saves considerable wiring outlay in the control circuit and shortens mounting time.

The HCS300I is a modular heating control system for the optimization of plastic processing machines. It enables individual solutions for many different heating control applications. With each basic unit it is possible to use up to four 6-channel digital outputs to control solid-state switching devices and four 4-channel temperature measuring modules. Current or current-and-voltage measuring modules can be used to monitor the loads. Communication with the higher-level control system is through Profibus DP.

See also www.siemens.com/heating-control



SIPLUS heating controls

SIRIUS 3RF3 – for switching motors

In order to achieve higher productivity, the switching frequency is continuously increased. It is no problem for our SIRIUS solid-state contactors to switch motors. With induction motors up to 7.5 kW, they can reliably withstand even the highest switching frequencies. Even a continuous change in the direction of rotation is possible with the solid-state reversing contactors. Both versions can be perfectly combined with components from the SIRIUS modular system. Connecting with SIRIUS motor starter protectors or SIRIUS overload relay can be implemented without any further steps.



Always on the sunny side with SIRIUS

Because SIRIUS 3RF2 offers even more:

- The space-saving and compact side-by-side mounting ensure reliable operation up to an ambient temperature of +60 °C.
- Thanks to fast configuration and the ease of mounting and start-up, you save not only time but also expenses.

Connection methods

The solid-state switching devices are available with screw terminals (box terminals), spring-type terminals or ring terminal lugs.

-  Screw terminals
-  Spring-type terminals
-  Ring terminal lug connections

The terminals are indicated in the corresponding tables by the symbols shown on orange backgrounds.

Overview



		SIRIUS 3RW30 Standard applications	SIRIUS 3RW40 Standard applications	SIRIUS 3RW44 High-Feature applications
Rated current at 40 °C	A	3 ... 106	12.5 ... 432	29 ... 1214
Rated operational voltage	V	200 ... 480	200 ... 600	200 ... 690
Motor rating at 400 V				
• Inline circuit	kW	1.5 ... 55	5.5 ... 250	15 ... 710
• Inside-delta circuit	kW	--	--	22 ... 1200
Ambient temperature	°C	-25 ... +60	-25 ... +60	0 ... +60
Soft starting/ramp-down		✓ ¹⁾	✓	✓
Voltage ramp		✓	✓	✓
Starting/stopping voltage	%	40 ... 100	40 ... 100	20 ... 100
Starting and ramp-down time	s	0 ... 20 ¹⁾	0 ... 20	1 ... 360
Torque control		--	--	✓
Starting/stopping torque	%	--	--	20 ... 100
Torque limit	%	--	--	20 ... 200
Ramp time	s	--	--	1 ... 360
Integral bypass contact system		✓	✓	✓
Intrinsic device protection		--	✓	✓
Motor overload protection		--	✓ ⁷⁾	✓
Thermistor motor protection		--	✓ ²⁾	✓
Integrated remote RESET		--	✓ ³⁾	✓
Adjustable current limiting		--	✓	✓
Inside-delta circuit		--	--	✓
Breakaway pulse		--	--	✓
Creep speed in both directions of rotation		--	--	✓
Pump ramp-down		--	--	✓ ⁴⁾
DC braking		--	--	✓ ⁴⁾ 5)
Combined braking		--	--	✓ ⁴⁾ 5)
Motor heating		--	--	✓
Communication		--	--	With PROFIBUS DP (optional)
External display and operator module		--	--	(optional)
Operating measured value display		--	--	✓
Error logbook		--	--	✓
Event list		--	--	✓
Slave pointer function		--	--	✓
Trace function		--	--	✓ ⁶⁾
Programmable control inputs and outputs		--	--	✓
Number of parameter sets		1	1	3
Parameterization software (Soft Starter ES)		--	--	✓
Power semiconductors (thyristors)		2 controlled phases	2 controlled phases	3 controlled phases
Screw terminals		✓	✓	✓
Spring-type terminals		✓	✓	✓
UL/CSA		✓	✓	✓
CE marking		✓	✓	✓
Soft starting under heavy starting conditions		--	--	✓ ⁴⁾

Configuring support

Win-Soft Starter, electronic selection slider ruler, Technical Assistance ++49 911 895 5900

- ✓ Function is available.
 -- Function not available.

- ¹⁾ Only soft starting available for 3RW30.
²⁾ Optional up to size S3 (device variant).
³⁾ Available for 3RW40 2.. to 3RW40 4.; optional for 3RW40 5.. and 3RW40 7..

- ⁴⁾ Calculate soft starter and motor with size allowance where required.
⁵⁾ Not possible in inside-delta circuit.
⁶⁾ Trace function with Soft Starter ES software.
⁷⁾ When using the motor overload protection according to ATEX, an upstream contactor is required.

You can find further information on the Internet at:
www.siemens.com/softstarter

SIRIUS 3RW Soft Starters

General data

Selection aid for soft starters



Application	SIRIUS 3RW30 Standard applications	SIRIUS 3RW40 Standard applications	SIRIUS 3RW44 High-Feature applications
Normal starting (CLASS 10)			
Pumps	●	●	●
Pumps with special pump ramp-down (to prevent water hammer)			●
Heat pumps	●	●	●
Hydraulic pumps	○	●	●
Presses	○	●	●
Conveyor belts	○	●	●
Roller conveyors	○	●	●
Screw conveyors	○	●	●
Escalators		●	●
Piston compressors		●	●
Screw compressors		●	●
Small fans ¹⁾		●	●
Centrifugal blowers		●	●
Bow thrusters		●	●
Heavy starting (CLASS 20)			
Stirrer		○	●
Extruders		○	●
Lathes		○	●
Milling machines		○	●
Very heavy starting (CLASS 30)			
Large fans ²⁾			●
Circular saws/bandsaws			●
Centrifuge			●
Mills			●
Breakers			●

● Recommended soft starter

○ Possible soft starter

¹⁾ The mass inertia of the fan is <10 times the mass inertia of the motor.

²⁾ The mass inertia of the fan is ≥10 times the mass inertia of the motor.

Boundary conditions

Type	Maximum starting time s	Current limiting %	Starts per hour 1/h
Normal starting (CLASS 10)			
• 3RW30	3	300	20
• 3RW40/44	10	300	5
Heavy starting (CLASS 20)			
• 3RW40 2., 3RW40 3., 3RW40 4.	20	300	5
• 3RW40 5., 3RW40 7., 3RW44	40	350	1
Very heavy starting (CLASS 30)			
• 3RW44	60	350	1

The motor ratings listed in the Selection and ordering data are rough guide values. The soft starter should always be designed on the basis of the required rated operational current of the motor. The 3RW soft starters are designed for easy starting conditions. In the event of more exacting requirements, it may be necessary to choose a larger device. However, in some cases the designed-in safety reserves also permit the listed units to be used in boundary conditions which are slightly more demanding.

Detailed technical information for a configuration which is tailored exactly to the application can be found in the manuals. Siemens recommends the use of the selection and simulation program Win-Soft Starter.

Motor rating data are based on DIN 42973 (kW) and NEC 96/UL508 (hp).

Order No. scheme

Digit of the Order No.	1st - 3rd	4th	5th	6th	7th		8th	9th	10th	11th	12th		13th	14th	15th	16th
	<input type="checkbox"/> <input type="checkbox"/> <input type="checkbox"/>	<input type="checkbox"/>	<input type="checkbox"/>	<input type="checkbox"/>	<input type="checkbox"/>	-	<input type="checkbox"/>	<input type="checkbox"/>	<input type="checkbox"/>	<input type="checkbox"/>	<input type="checkbox"/>	-	<input type="checkbox"/>	<input type="checkbox"/>	<input type="checkbox"/>	<input type="checkbox"/>
Soft starters	3 R W															
SIRIUS soft starter generation	<input type="checkbox"/>															
Size	<input type="checkbox"/>															
Rated operational current I_e	<input type="checkbox"/>															
Connection type (screw terminals / spring-type terminals)	<input type="checkbox"/>															
Soft starter functionality (bypass, thermistor, etc.)	<input type="checkbox"/>															
Rated control supply voltage U_s	<input type="checkbox"/>															
Rated operational voltage U_e	<input type="checkbox"/>															
Special versions	<input type="checkbox"/>															
Example	3	R	W	4	0	2	4	-	1	B	B	1	4			

Note:

The Order No. scheme is presented here merely for information purposes and for better understanding of the logic behind the order numbers.

For your orders, please use the order numbers quote in the catalog in the Selection and ordering data.

Benefits

The advantages of the SIRIUS soft starters at a glance:

- Soft starting and smooth ramp-down (only soft starting available for 3RW30)
- Stepless starting
- Reduction of current peaks
- Avoidance of mains voltage fluctuations during starting
- Reduced load on the power supply network
- Reduction of the mechanical load in the operating mechanism
- Considerable space savings and reduced wiring compared with conventional starters
- Maintenance-free switching
- Very easy handling
- Fits perfectly in the SIRIUS modular system

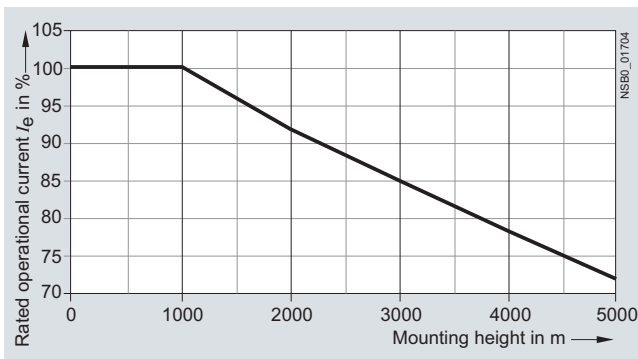
Technical specifications**Permissible installation altitude**

At an installation altitude above 2000 m, the max. permissible operational voltage is reduced to 460 V.

SIRIUS 3RW Soft Starters

3RW30, 3RW40 for Standard Applications

3RW30

Overview

The SIRIUS 3RW30 soft starters reduce the motor voltage through variable phase control and increase it in ramp-like mode from a selectable starting voltage up to mains voltage. During starting, these devices limit the torque as well as the current and prevent the shocks which arise during direct starts or wye-delta starts. In this way, mechanical loads and mains voltage dips can be reliably reduced.

Soft starting reduces the stress on the connected equipment and results in lower wear and therefore longer periods of trouble-free production. The selectable start value means that the soft starters can be adjusted individually to the requirements of the application in question and unlike wye-delta starters are not restricted to two-stage starting with fixed voltage ratios.

The SIRIUS 3RW30 soft starters are characterized above all by their small space requirements. Integrated bypass contacts mean that no power loss has to be taken into the bargain at the power semiconductors (thyristors) after the motor has started up. This cuts down on heat losses, enabling a more compact design and making external bypass circuits superfluous.

Various versions of the SIRIUS 3RW30 soft starters are available:

- Standard version for fixed-speed three-phase motors, sizes S00, S0, S2 and S3, with integrated bypass contact system
- Version for fixed-speed three-phase motors in a 22.5 mm enclosure without bypass

Soft starters rated up to 55 kW (at 400 V) for standard applications in three-phase networks are available. Extremely small sizes, low power losses and simple commissioning are just three of the many advantages of this soft starter.

Functionality

The space required by the compact SIRIUS 3RW30 soft starter is often only about one third of that required by a contactor assembly for wye-delta starting of comparable rating. This not only saves space in the control cabinet and on the standard mounting rail but also does away completely with the wiring work needed for wye-delta starters. This is notable in particular for higher motor ratings which are only rarely available as fully wired solutions.

At the same time the number of cables from the starter to the motor is reduced from six to three. Compact dimensions, short start-up times, easy wiring and fast commissioning make themselves felt as clear-cut cost advantages.

The bypass contacts of these soft starters are protected during operation by an integrated solid-state arc quenching system. This prevents damage to the bypass contacts in the event of a fault, e. g. brief disconnection of the control voltage, mechanical shocks or life-related component defects on the coil operating mechanism or main contact spring.

The new series of devices comes with the "polarity balancing" control method, which is designed to prevent direct current components in two-phase controlled soft starters. On two-phase controlled soft starters the current resulting from superimposition of the two controlled phases flows in the uncontrolled phase. This results for physical reasons in an asymmetric distribution of the three phase currents during the motor ramp-up. This phenomenon cannot be influenced, but in most applications it is non-critical.

Controlling the power semiconductors results not only in this asymmetry, however, but also in the previously mentioned direct current components which can cause severe noise generation on the motor at starting voltages of less than 50 %. The control method used for these soft starters eliminates these direct current components during the ramp-up phase and prevents the braking torque which they can cause.

It creates a motor ramp-up that is uniform in speed, torque and current rise, thus permitting a particularly gentle, two-phase starting of the motors. At the same time the acoustic quality of

the starting operation comes close to the quality of a three-phase controlled soft starter. This is made possible by the on-going dynamic harmonizing and balancing of current half-waves of different polarity during the motor ramp-up. Hence the name "polarity balancing".

- Soft starting with voltage ramp; the starting voltage setting range U_s is 40 to 100 % and the ramp time t_R can be set from 0 to 20 s.
- Integrated bypass contact system to minimize power loss
- Setting with two potentiometers
- Simple mounting and commissioning
- Mains voltages 50/60 Hz, 200 to 480 V
- Two control voltage versions 24 V AC/DC and 110 to 230 V AC/DC
- Wide temperature range from -25 to +60 °C
- The built-in auxiliary contact ensures user-friendly control and possible further processing within the system ([for status graphs see page 4/17](#))

Application

The 3RW30 soft starters are suitable for soft starting of three-phase asynchronous motors.

Due to two-phase control, the current is kept at minimum values in all three phases throughout the entire starting time. Due to continuous voltage influencing, the current and torque peaks which are unavoidable in the case of wye-delta starters for instance do not occur.

Application areas

See "Selection aid for soft starters" on page 4/6.

SIRIUS 3RW Soft Starters

3RW30, 3RW40 for Standard Applications

3RW30

Technical specifications

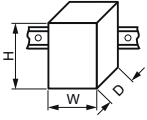
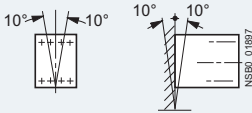
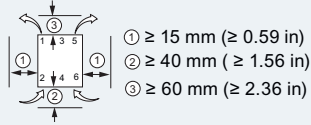
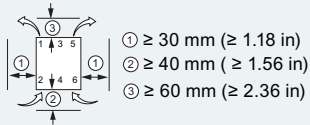
Type		3RW30 1.	3RW30 2.	3RW30 3.	3RW30 4.	
Mechanics and environment						
Mounting dimensions (WxHxD)						
<ul style="list-style-type: none"> Screw terminals Spring-type terminals 		mm	45 x 95 x 151	45 x 125 x 151	55 x 144 x 168	70 x 160 x 186
		mm	45 x 117.2 x 151	45 x 150 x 151	55 x 144 x 168	70 x 160 x 186
Permissible ambient temperature						
Operation	°C	-25 ... +60; (derating from +40)				
Storage	°C	-40 ... +80				
Weight						
	kg	0.58	0.69	1.20	1.71	
Permissible mounting position¹⁾ (auxiliary fan not available)						
						
Installation type¹⁾						
	Stand-alone installation					
		① ≥ 15 mm (≥ 0.59 in) ② ≥ 40 mm (≥ 1.56 in) ③ ≥ 60 mm (≥ 2.36 in)		① ≥ 30 mm (≥ 1.18 in) ② ≥ 40 mm (≥ 1.56 in) ③ ≥ 60 mm (≥ 2.36 in)		
Permissible installation altitude						
	m	5 000 (derating from 1000, see Characteristic curves page 4/7); higher on request				
Degree of protection						
		IP20		IP00		

¹⁾ In case of deviations, please note derating (see [Manual in Chapter "Configuration"](#)).

Type		3RW30 1. to 3RW30 4.	
Control electronics			
Rated values			
Rated control supply voltage	Terminal A1/A2	V	24 110 ... 230
		%	±20 -15/+10
Rated frequency		Hz	50/60
		%	±10

Type		3RW30 1. to 3RW30 4.	
Power electronics			
Rated operational voltage			
	V AC	200 ... 480	
Tolerance	%	-15/+10	
Rated frequency			
	Hz	50/60	
Tolerance	%	±10	
Uninterrupted duty at 40 °C (% of I_e)			
	%	115	
Minimum load (% of I_e)			
	%	10 (at least 2 A)	
Maximum cable length between soft starter and motor			
	m	300	

SIRIUS 3RW Soft Starters

3RW30, 3RW40 for Standard Applications

3RW30

Type		3RW30 03-1CB54	3RW30 03-2CB54
Mechanics and environment			
Mounting dimensions (WxHxD)			
<ul style="list-style-type: none"> Screw terminals Spring-type terminals 		mm	22.5 x 100 x 120
		mm	--
			22.5 x 101.6 x 120
Permissible ambient temperature			
Operation	°C	-25 ... +60; (derating from +40)	
Storage	°C	-40 ... +80	
Weight	kg	0.207	0.188
Permissible mounting position			
Permissible installation altitude			
	m	5 000 (derating from 1000, see Characteristic curves page 4/7); higher on request	
Degree of protection acc. to IEC 60529			
IP20 (IP00 terminal compartment)			
Control electronics			
Rated values			
Rated control supply voltage	V	24 ... 230 AC/DC	
• Tolerance	%	± 10	
Rated frequency at AC	Hz	50/60	
• Tolerance	%	± 10	
Power electronics			
Rated operational voltage	V AC	200 ... 400	
Tolerance	%	± 10	
Rated frequency	Hz	50/60	
Tolerance	%	± 10	
Uninterrupted duty (% of I_e)	%	100	
Minimum load¹⁾ (% of I_e); at 40 °C	%	9	
Maximum conductor length between soft starter and motor	m	100 ²⁾	

1) The rated motor current (specified on the motor's name plate) should at least amount to the specified percentage of the SIRIUS soft starter unit's rated operational current I_e .

2) If this value is exceeded, problems with line capacities may arise, which can result in false firing.

SIRIUS 3RW Soft Starters

3RW30, 3RW40 for Standard Applications

3RW30

Motor feeders with soft starters

The type of coordination to which the motor feeder with soft starter is mounted depends on the application-specific requirements. Normally, fuseless mounting (combination of motor starter protector/circuit breaker and soft starter) is sufficient.

If type of coordination "2" is to be fulfilled, semiconductor fuses must be fitted in the motor feeder.

T_{OC} 1

Type of coordination "1" according to IEC 60947-4-1: After a short-circuit incident the unit is defective therefore unsuitable for further use (protection of persons and equipment guaranteed).

T_{OC} 2

Type of coordination "2" according to IEC 60947-4-1: After a short-circuit incident the unit is suitable for further use (protection of persons and equipment guaranteed).

The type of coordination refers to soft starters in combination with the stipulated protective device (motor starter protector/circuit breaker/fuse), not to any additional components in the feeder.

The types of coordination are indicated in the corresponding tables by the symbols shown on orange backgrounds.

4

Fuseless version

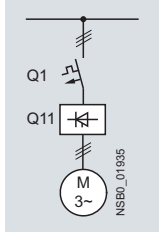

Soft starters		Motor starter protectors ¹⁾		
T _{OC} 1	Rated current	400 V +10 %		
Q11		Q1	I _{q max}	Rated current
Type	A	Type	kA	A
Type of coordination "1"				
3RW30 03	3	3RV20 11-1EA..	50	4
3RW30 13	3.6	3RV20 11-1FA..	5	5
3RW30 14	6.5	3RV20 11-1HA..	5	8
3RW30 16	9	3RV20 11-1JA..	5	10
3RW30 17	12.5	3RV20 11-1KA..	5	12.5
3RW30 18	17.6	3RV20 21-4BA..	5	20
3RW30 26	25	3RV20 21-4DA..	55	25
3RW30 27	32	3RV20 21-4EA..	55	32
3RW30 28	38	3RV20 21-4FA..	55	40
3RW30 36	45	3RV10 31-4GA10	20	45
3RW30 37	63	3RV10 41-4JA10	20	63
3RW30 38	72	3RV10 41-4KA10	20	75
3RW30 46	80	3RV10 41-4LA10	11	90
3RW30 47	106	3RV10 41-4MA10	11	100

¹⁾ The rated motor current must be considered when selecting the devices.

SIRIUS 3RW Soft Starters

3RW30, 3RW40 for Standard Applications

3RW30

Fused version (line protection only)

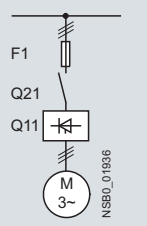

Soft starters		Line fuses, maximum			Line contactors
Q11 Type	Rated current A	F1 Type	Rated current A	Size	Q21 (optional)
Type of coordination "1"¹⁾: $I_q = 65 \text{ kA at } 480 \text{ V} + 10 \%$					
3RW30 03 ²⁾	3	3NA3 805 ³⁾	20	000	3RT10 15
3RW30 13	3.6	3NA3 803-6	10	000	3RT10 15
3RW30 14	6.5	3NA3 805-6	16	000	3RT10 15
3RW30 16	9	3NA3 807-6	20	000	3RT10 16
3RW30 17	12.5	3NA3 810-6	25	000	3RT10 24
3RW30 18	17.6	3NA3 814-6	35	000	3RT10 26
3RW30 26	25	3NA3 822-6	63	00	3RT10 26
3RW30 27	32	3NA3 824-6	80	00	3RT10 34
3RW30 28	38	3NA3 824-6	80	00	3RT10 35
3RW30 36	45	3NA3 130-6	100	1	3RT10 36
3RW30 37	63	3NA3 132-6	125	1	3RT10 44
3RW30 38	72	3NA3 132-6	125	1	3RT10 45
3RW30 46	80	3NA3 136-6	160	1	3RT10 45
3RW30 47	106	3NA3 136-6	160	1	3RT10 46

¹⁾ The type of coordination "1" refers to soft starters in combination with the stipulated fuse, not to any additional components in the feeder.

²⁾ $I_q = 50 \text{ kA at } 400 \text{ V}$.

³⁾ 3NA3 805-1 (NH00), 5SB2 61 (DIAZED), 5SE2 201-6 (NEOZED).

Fused version with 3NE1 SITOR fuses (semiconductor and line protection)

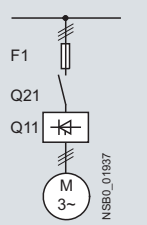

For matching fuse bases see Catalog LV 10.1

- "Switch Disconnectors"
- "Fuse Systems" --> "SITOR Semiconductor Fuses" or at www.siemens.com/sitor

Soft starters		All-range fuses			Line contactors
Q11 Type	Rated current A	F1 Type	Rated current A	Size	Q21 (optional)
Type of coordination "2"¹⁾: $I_q = 65 \text{ kA at } 480 \text{ V} + 10 \%$					
3RW30 03 ²⁾	3	3NE1 813-0 ³⁾	16	000	3RT10 15
3RW30 13	3.6	3NE1 813-0	16	000	3RT10 15
3RW30 14	6.5	3NE1 813-0	16	000	3RT10 15
3RW30 16	9	3NE1 813-0	16	000	3RT10 16
3RW30 17	12.5	3NE1 813-0	16	000	3RT10 24
3RW30 18	17.6	3NE1 814-0	20	000	3RT10 26
3RW30 26	25	3NE1 803-0	35	000	3RT10 26
3RW30 27	32	3NE1 020-2	80	00	3RT10 34
3RW30 28	38	3NE1 020-2	80	00	3RT10 35
3RW30 36	45	3NE1 020-2	80	00	3RT10 36
3RW30 37	63	3NE1 820-0	80	000	3RT10 44
3RW30 38	72	3NE1 820-0	80	000	3RT10 45
3RW30 46	80	3NE1 021-0	100	00	3RT10 45
3RW30 47	106	3NE1 022-0	125	00	3RT10 46

¹⁾ The type of coordination "2" refers to soft starters in combination with the stipulated fuse, not to any additional components in the feeder.

²⁾ $I_q = 50 \text{ kA at } 400 \text{ V}$.

³⁾ No SITOR fuse required! Alternatively: 3NA3 803 (NH00), 5SB2 21 (DIAZED), 5SE2 206 (NEOZED).

SIRIUS 3RW Soft Starters

3RW30, 3RW40 for Standard Applications

3RW30

Fused version with 3NE3 SITOR fuses (semiconductor protection by fuse, line and overload protection by motor starter protector; alternatively, installation with contactor and overload relay possible)

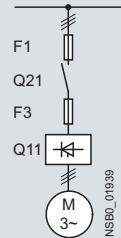
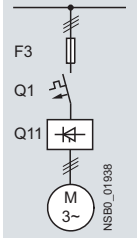

For matching fuse bases see Catalog LV 10.1

- "Switch Disconnectors"
- "Fuse Systems" --> "SITOR Semiconductor Fuses" or at www.siemens.com/sitor

Soft starters Q11 Type	Rated current A	Semiconductor fuses, minimum			Semiconductor fuses, maximum			Semiconductor fuses, minimum		
		F3 Type	Rated current A	Size	F3 Type	Rated current A	Size	F3 Type	Rated current A	Size
Type of coordination "2" ¹⁾ : $I_q = 65 \text{ kA at } 480 \text{ V} + 10 \%$										
3RW30 03 ²⁾	3	--	--	--	--	--	--	--	--	--
3RW30 13	3.6	--	--	--	--	--	--	3NE4 101	32	0
3RW30 14	6.5	--	--	--	--	--	--	3NE4 101	32	0
3RW30 16	9	--	--	--	--	--	--	3NE4 101	32	0
3RW30 17	12.5	--	--	--	--	--	--	3NE4 101	32	0
3RW30 18	17.6	--	--	--	3NE3 221	100	1	3NE4 101	32	0
3RW30 26	25	--	--	--	3NE3 221	100	1	3NE4 102	40	0
3RW30 27	32	--	--	--	3NE3 222	125	1	3NE4 118	63	0
3RW30 28	38	--	--	--	3NE3 222	125	1	3NE4 118	63	0
3RW30 36	45	--	--	--	3NE3 224	160	1	3NE4 120	80	0
3RW30 37	63	--	--	--	3NE3 225	200	1	3NE4 121	100	0
3RW30 38	72	3NE3 221	100	1	3NE3 227	250	1	--	--	--
3RW30 46	80	3NE3 222	125	1	3NE3 225	200	1	--	--	--
3RW30 47	106	3NE3 224	160	1	3NE3 231	350	1	--	--	--

Soft starters Q11 Type	Rated current A	Semiconductor fuses, max.			Semiconductor fuses, min.			Semiconductor fuses, max.			Cylindrical fuses	
		F3 Type	Rated current A	Size	F3 Type	Rated current A	Size	F3 Type	Rated current A	Size	F3 Type	Rated current A
Type of coordination "2" ¹⁾ : $I_q = 65 \text{ kA at } 480 \text{ V} + 10 \%$												
3RW30 03 ²⁾	3	--	--	--	3NE8 015-1	25	00	3NE8 015-1	25	00	3NC1 010	10
3RW30 13	3.6	--	--	--	3NE8 015-1	25	00	3NE8 015-1	25	00	3NC2 220	20
3RW30 14	6.5	--	--	--	3NE8 015-1	25	00	3NE8 015-1	25	00	3NC2 220	20
3RW30 16	9	--	--	--	3NE8 015-1	25	00	3NE8 015-1	25	00	3NC2 220	20
3RW30 17	12.5	--	--	--	3NE8 015-1	25	00	3NE8 018-1	63	00	3NC2 250	50
3RW30 18	17.6	--	--	--	3NE8 003-1	35	00	3NE8 021-1	100	00	3NC2 263	63
3RW30 26	25	3NE4 117	50	0	3NE8 017-1	50	00	3NE8 021-1	100	00	3NC2 263	63
3RW30 27	32	3NE4 118	63	0	3NE8 018-1	63	00	3NE8 022-1	125	00	3NC2 280	80
3RW30 28	38	3NE4 118	63	0	3NE8 020-1	80	00	3NE8 022-1	125	00	3NC2 280	80
3RW30 36	45	3NE4 120	80	0	3NE8 020-1	80	00	3NE8 024-1	160	00	3NC2 280	80
3RW30 37	63	3NE4 121	100	0	3NE8 021-1	100	00	3NE8 024-1	160	00	--	--
3RW30 38	72	--	--	--	3NE8 022-1	125	00	3NE8 024-1	160	00	--	--
3RW30 46	80	--	--	--	3NE8 022-1	125	00	3NE8 024-1	160	00	--	--
3RW30 47	106	--	--	--	3NE8 024-1	160	00	3NE8 024-1	160	00	--	--

Soft starters Q11 Type	Rated current A	Line contactors (optional) Q21	Motor starter protectors 400 V +10 %		Line fuses, maximum		
			Q1 Type	Rated current A	F1 Type	Rated current A	Size
Type of coordination "2" ¹⁾ : $I_q = 65 \text{ kA at } 480 \text{ V} + 10 \%$							
3RW30 03 ²⁾	3	3RT10 15	3RV20 11-1EA..	4	3NA3 805 ³⁾	20	000
3RW30 13	3.6	3RT10 15	3RV20 11-1FA..	5	3NA3 803-6	10	000
3RW30 14	6.5	3RT10 15	3RV20 11-1HA..	8	3NA3 805-6	16	000
3RW30 16	9	3RT10 16	3RV20 11-1JA..	10	3NA3 807-6	20	000
3RW30 17	12.5	3RT10 24	3RV20 11-1KA..	12.5	3NA3 810-6	25	000
3RW30 18	17.6	3RT10 26	3RV20 21-4BA..	20	3NA3 814-6	35	000
3RW30 26	25	3RT10 26	3RV20 21-4DA..	25	3NA3 822-6	63	00
3RW30 27	32	3RT10 34	3RV20 21-4EA..	32	3NA3 824-6	80	00
3RW30 28	38	3RT10 35	3RV20 21-4FA..	40	3NA3 824-6	80	00
3RW30 36	45	3RT10 36	3RV10 31-4GA10	45	3NA3 130-6	100	1
3RW30 37	63	3RT10 44	3RV10 41-4JA10	63	3NA3 132-6	125	1
3RW30 38	72	3RT10 45	3RV10 41-4KA10	75	3NA3 132-6	125	1
3RW30 46	80	3RT10 45	3RV10 41-4LA10	90	3NA3 136-6	160	1
3RW30 47	106	3RT10 46	3RV10 41-4MA10	100	3NA3 136-6	160	1

¹⁾ The type of coordination "2" refers to soft starters in combination with the stipulated protective device (motor starter protector/fuse), not to any additional components in the feeder.

²⁾ $I_q = 50 \text{ kA at } 400 \text{ V}$.

³⁾ 3NA3 805-1 (NH00), 5SB2 61 (DIAZED).

SIRIUS 3RW Soft Starters

3RW30, 3RW40 for Standard Applications

3RW30

Selection and ordering data



3RW ambient temperature 40 °C ¹⁾				3RW ambient temperature 50 °C ¹⁾				Size	DT	Order No.	Price per PU	PU (UNIT, SET, M)	PS*	PG
Rated values of induction motors		Rated values of induction motors		Operational current I _e		Rating at operational voltage U _e								
Operational current I _e	Rating at operational voltage U _e			Operational current I _e	Rating at operational voltage U _e									
	230 V	400 V	500 V		200 V	230 V	460 V	575 V						
A	kW	kW	kW	A	hp	hp	hp	hp						

Rated operational voltage U _e 200 ... 480 V ²⁾														
• With screw terminals														
3.6	0.75	1.5	--	3	0.5	0.5	1.5	--	S00	▶	3RW30 13-1BB□4	1	1 unit	131
6.5	1.5	3	--	4.8	1	1	3	--	S00	▶	3RW30 14-1BB□4	1	1 unit	131
9	2.2	4	--	7.8	2	2	5	--	S00	▶	3RW30 16-1BB□4	1	1 unit	131
12.5	3	5.5	--	11	3	3	7.5	--	S00	▶	3RW30 17-1BB□4	1	1 unit	131
17.6	4	7.5	--	17	3	3	10	--	S00	▶	3RW30 18-1BB□4	1	1 unit	131
• With spring-type terminals														
3.6	0.75	1.5	--	3	0.5	0.5	1.5	--	S00	B	3RW30 13-2BB□4	1	1 unit	131
6.5	1.5	3	--	4.8	1	1	3	--	S00	B	3RW30 14-2BB□4	1	1 unit	131
9	2.2	4	--	7.8	2	2	5	--	S00	B	3RW30 16-2BB□4	1	1 unit	131
12.5	3	5.5	--	11	3	3	7.5	--	S00	B	3RW30 17-2BB□4	1	1 unit	131
17.6	4	7.5	--	17	3	3	10	--	S00	B	3RW30 18-2BB□4	1	1 unit	131
• With screw terminals														
25	5.5	11	--	23	5	5	15	--	S0	▶	3RW30 26-1BB□4	1	1 unit	131
32	7.5	15	--	29	7.5	7.5	20	--	S0	▶	3RW30 27-1BB□4	1	1 unit	131
38	11	18.5	--	34	10	10	25	--	S0	▶	3RW30 28-1BB□4	1	1 unit	131
• With spring-type terminals														
25	5.5	11	--	23	5	5	15	--	S0	B	3RW30 26-2BB□4	1	1 unit	131
32	7.5	15	--	29	7.5	7.5	20	--	S0	B	3RW30 27-2BB□4	1	1 unit	131
38	11	18.5	--	34	10	10	25	--	S0	B	3RW30 28-2BB□4	1	1 unit	131
• With screw or spring-type terminals														
45	11	22	--	42	10	15	30	--	S2	▶	3RW30 36-□BB□4	1	1 unit	131
63	18.5	30	--	58	15	20	40	--	S2	▶	3RW30 37-□BB□4	1	1 unit	131
72	22	37	--	62	20	20	40	--	S2	▶	3RW30 38-□BB□4	1	1 unit	131
• With screw or spring-type terminals														
80	22	45	--	73	20	25	50	--	S3	▶	3RW30 46-□BB□4	1	1 unit	131
106	30	55	--	98	30	30	75	--	S3	▶	3RW30 47-□BB□4	1	1 unit	131

Order No. supplement for connection types

- With screw terminals
- With spring-type terminals³⁾

1
2

0
1

Order No. supplement for rated control supply voltage U_s

- 24 V AC/DC
- 110 ... 230 V AC/DC

Soft starters for easy starting conditions and high switching frequency, rated operational voltage U_e 200 ... 400 V, rated control supply voltage U_s 24 ... 230 V AC/DC

3	0.55	1.1	--	2.6	0.5	0.5	--	--	22.5 mm					
• With screw terminals										▶	3RW30 03-1CB54	1	1 unit	131
• With spring-type terminals										B	3RW30 03-2CB54	1	1 unit	131

¹⁾ Stand-alone installation.

²⁾ Soft starter with screw terminals: delivery time class ▶ (preferred type).

³⁾ Main circuit connection: screw terminals.

Note:

The listed motor ratings are rough guide values. The soft starter should always be designed on the basis of the required rated operational current of the motor.

The SIRIUS 3RW30 solid-state soft starters are designed for easy starting conditions. The selection and ordering data were

determined for the following boundary conditions (see also the notes on page 4/6):



- Maximum starting time in s: 3
- Maximum starting current in % of motor current I_e: 300
- Maximum number of starts per hour in 1/h: 20

SIRIUS 3RW Soft Starters

3RW30, 3RW40 for Standard Applications

3RW30

Accessories

Conductor cross-section		Tightening torque	For soft starters size	DT	Order No.	Price per PU	PU (UNIT, SET, M)	PS*	PG								
Solid or stranded	Finely stranded with end sleeve									AWG cables, solid or stranded							
mm ²	mm ²	AWG	Nm														
Three-phase feeder terminals																	
		2.5 ... 16	2.5 ... 16	10 ... 4	3 ... 4	S00 (3RW30 1.), S0 (3RW30 2.)	A	3RV29 25-5AB	1	1 unit	101						
3RV29 25-5AB																	
For soft starters		Type		Size		DT		Order No.		Price per PU		PU (UNIT, SET, M)		PS*		PG	
Auxiliary terminals																	
Auxiliary terminals, 3-pole																	
3RW30 4.		S3				B		3RT19 46-4F		1		1 unit		101			
Covers for soft starters																	
Terminal covers for box terminals																	
Additional touch protection to be fitted at the box terminals (2 units required per device)																	
3RW30 3.		S2				▶		3RT19 36-4EA2		1		1 unit		101			
3RW30 4.		S3				▶		3RT19 46-4EA2		1		1 unit		101			
																	
Terminal covers for cable lugs and busbar connections																	
For complying with the phase clearances and as touch protection if box terminal is removed (2 units required per contactor)																	
3RW30 4.		S3				▶		3RT19 46-4EA1		1		1 unit		101			
3RT19 46-4EA1																	
Manuals 3RW30/3RW40¹⁾																	
3RW30 1.		S00				C		3ZX10 12-0RW30-1AB1		1		1 unit		191			
3RW30 2.		S0															
3RW30 3.		S2															
3RW30 4.		S3															
Operating instructions¹⁾																	
3RW30 1.		S00						3ZX10 12-0RW30-2DA1									
3RW30 2.		S0															
3RW30 3.		S2															
3RW30 4.		S3															

¹⁾ The operating instructions are included in the scope of supply of the soft starter or are available – like the manual – as a PDF download from the Service&Support portal at www.siemens.com/industrial-controls/support
--> Controls --> Soft Starters and Solid-State Switching Devices --> SIRIUS 3RW Soft Starters.

SIRIUS 3RW Soft Starters

3RW30, 3RW40 for Standard Applications

3RW30

For soft starters	Motor starter protectors	DT	Order No.	Price per PU	PU (UNIT, SET, M)	PS*	PG
Type	Size	Size					

Link modules to motor starter protectors¹⁾

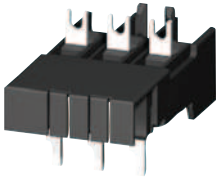

- With screw terminals

3RW30 1.	S00	S00	A	3RA29 21-1BA00	1	1 unit	101
3RW30 2.	S0	S00/S0	A	3RA29 21-1BA00	1	1 unit	101
3RW30 36.	S2	S2	▶	3RA19 31-1AA00	1	1 unit	101
3RW30 46., 3RW30 47.	S3	S3	▶	3RA19 41-1AA00	1	1 unit	101

- With spring-type terminals

3RW30 1.	S00	S00	A	3RA29 11-2GA00	1	1 unit	101
3RW30 2.	S0	S0	A	3RA29 21-2GA00	1	1 unit	101

¹⁾ Can be used in size S0 up to maximum 32 A.
Can be used in size S00/S0 only for 3RV2 motor starter protectors.

Version	Functionality Functions	DT	Order No.	Price per PU	PU (UNIT, SET, M)	PS*	PG
---------	-------------------------	----	-----------	--------------	-------------------	-----	----

Covers and push-in lugs (only for 3RW30 03)



3RP1 902



3RP1 903

Sealable covers	For securing against unauthorized adjustment of setting knobs	▶	3RP1 902		1	5 units	101
Push-in lugs	For screw fixing	▶	3RP1 903		1	10 units	101

Version	DT	Order No.	Price per PU	PU (UNIT, SET, M)	PS*	PG
---------	----	-----------	--------------	-------------------	-----	----

Tool for opening spring-type terminals for sizes S00 and S0



3RA29 08-1A

Screwdrivers
For all SIRIUS devices with spring-type terminals length approx. 200 mm, 3.0 mm x 0.5 mm, titanium gray/black, partially insulated

Spring-type terminals							
		A	3RA29 08-1A		1	1 unit	101

Blank labels

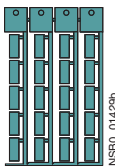

3RT19 00-1SB20

Unit labeling plates¹⁾
For SIRIUS devices
20 mm x 7 mm, pastel turquoise

	D	3RT19 00-1SB20		100	340 units	101
--	---	-----------------------	--	-----	-----------	-----

SIRIUS 3RW Soft Starters

3RW30, 3RW40 for Standard Applications

3RW30

More information

Application examples for normal starting (CLASS 10)

Normal starting CLASS 10 (up to 20 s with 300 % $I_{n,motor}$)
The soft starter rating can be selected to be as high as the rating of the motor used

Application	Conveyor belt	Roller conveyor	Compressor	Small fan ¹⁾	Pump	Hydraulic pump
Starting parameters						
• Voltage ramp and current limiting						
- Starting voltage	%	70	60	50	40	40
- Starting time	s	10	10	20	10	10

¹⁾ The mass inertia of the fan is <10 times the mass inertia of the motor.

Note:

These tables present sample set values and device sizes. They are intended only for the purposes of information and are not binding. The set values depend on the application in question and must be optimized during commissioning. The soft starter dimensions should be checked where necessary with the Win-Soft Starter software or with the help of Technical Assistance.

Configuration

The 3RW solid-state motor controllers are designed for easy starting conditions. In the event of deviating conditions or increased switching frequency, it may be necessary to choose a larger device. For accurate dimensioning, use the Win-Soft Starter selection and simulation program.

If necessary, an overload relay for heavy starting must be selected where long starting times are involved. PTC sensors are recommended.

No capacitive elements are permitted in the motor feeder between the SIRIUS 3RW soft starter and the motor (e. g. no reactive-power compensation equipment). In addition, neither static systems for reactive-power compensation nor dynamic PFC (Power Factor Correction) must be operated in parallel during starting and ramp-down of the soft starter. This is important to prevent faults arising on the compensation equipment and/or the soft starter.

All elements of the main circuit (such as fuses, controls and overload relays) should be dimensioned for direct starting, following the local short-circuit conditions. Fuses, controls and overload relays must be ordered separately. Please observe the maximum switching frequencies specified in the technical specifications.

Note:

When induction motors are switched on, voltage drops occur as a rule on starters of all types (direct starters, wye-delta starters, soft starters). The infeed transformer must always be dimensioned such that the voltage dip when starting the motor remains within the permissible tolerance. If the infeed transformer is dimensioned with only a small margin, it is best for the control voltage to be supplied from a separate circuit (independently of the main voltage) in order to avoid the potential switching off of the soft starter.

Schematic circuit diagram of power electronics

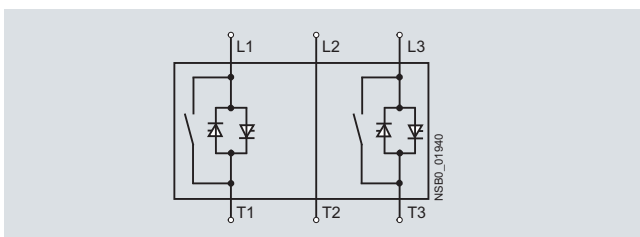

A bypass contact system is already integrated in the 3RW30 soft starter and therefore does not have to be ordered separately.

Status graphs

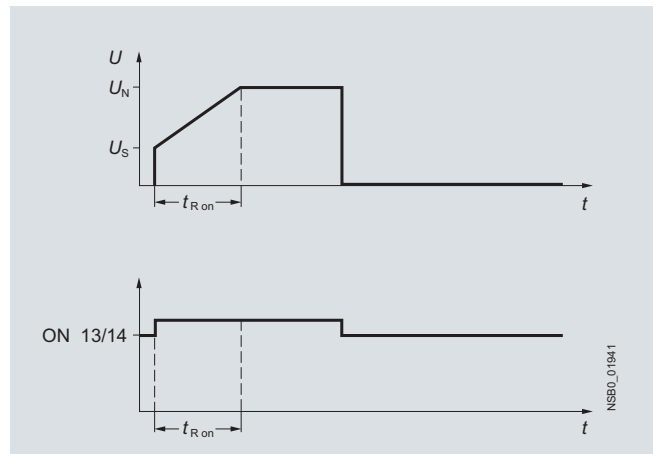

Manual for SIRIUS 3RW30/40

Besides containing all important information on configuring, commissioning and servicing, the manual also contains example circuits and the technical specifications for all devices.

Win-Soft Starter selection and simulation program

With this software, you can simulate and select all Siemens soft starters, taking into account various parameters such as mains properties, motor and load data, and special application requirements.

The software is a valuable tool, which makes complicated, lengthy manual calculations for determining the required soft starters superfluous.

The Win-Soft Starter selection and simulation program can be downloaded from:

www.siemens.com/softstarter --> Software

You can find more information about soft starters on the Internet likewise at:

www.siemens.com/softstarter

Training course for SIRIUS soft starters (SD-SIRIUSO)

Siemens offers a 2-day training course on the SIRIUS solid-state soft starters to keep customers and own personnel up-to-date on configuring, commissioning and maintenance issues.

You can find more information on our SITRAIN website:

www.siemens.com/sitrain

--> For course name select "SD-SIRIUSO"

Please direct enquiries and applications to SITRAIN Customer Support:

Tel.: +49 (1805) 23 56 11

Fax: +49 (1805) 23 56 12

E-mail: info@sitrain.com

SIRIUS 3RW Soft Starters

3RW30, 3RW40 for Standard Applications

3RW40

Overview

SIRIUS 3RW40 soft starters have all the same advantages as the 3RW30 soft starters.

The SIRIUS 3RW40 soft starters are characterized above all by their small space requirements. Integrated bypass contacts mean that no power loss has to be taken into the bargain at the power semiconductors (thyristors) after the motor has started up. This cuts down on heat losses, enabling a more compact design and making external bypass circuits superfluous.

At the same time this soft starter comes with additional integrated functions such as adjustable current limiting, motor overload and intrinsic device protection, and optional thermistor motor protection. The higher the motor rating, the more important these functions because they make it unnecessary to purchase and install protection equipment such as overload relays.

Internal intrinsic device protection prevents the thermal overloading of the thyristors and the power section defects this can cause. As an option the thyristors can also be protected by semiconductor fuses from short-circuiting.

Thanks to integrated status monitoring and fault monitoring, this compact soft starter offers many different diagnostics options. Up to four LEDs and relay outputs permit differentiated monitoring and diagnostics of the operating mechanism by indicating the operating state as well as for example mains or phase failure, missing load, non-permissible tripping time/class setting, thermal overloading or device faults.

Soft starters rated up to 250 kW (at 400 V) for standard applications in three-phase networks are available. Extremely small sizes, low power losses and simple start-up are just three of the many advantages of the SIRIUS 3RW40 soft starters.

"Increased safety" type of protection EEx e according to ATEX directive 94/9/EC

The 3RW40 soft starter sizes S0 to S12 are suitable for the starting of explosion-proof motors with "increased safety" type of protection EEx e. See www.siemens.com/industrial-controls/atex.

Functionality

The space required by the compact SIRIUS 3RW40 soft starter is often only about one third of that required by a contactor assembly for wye-delta starting of comparable rating. This not only saves space in the control cabinet and on the standard mounting rail but also does away completely with the wiring work needed for wye-delta starters. This is notable in particular for higher motor ratings which are only rarely available as fully wired solutions.

At the same time the number of cables from the starter to the motor is reduced from six to three. Compact dimensions, short start-up times, easy wiring and fast commissioning make themselves felt as clear-cut cost advantages.

The bypass contacts of these soft starters are protected during operation by an integrated solid-state arc quenching system. This prevents damage to the bypass contacts in the event of a fault, e. g. brief disconnection of the control voltage, mechanical shocks or life-related component defects on the coil operating mechanism or main contact spring.

The starting current of particularly powerful operating mechanisms can place an unjustifiable load on the local supply system. Soft starters reduce this starting current by means of their voltage ramp. Thanks to the adjustable current limiting, the SIRIUS 3RW40 soft starter takes even more pressure off the supply system. It leaves the set start ramp during the ramp-up – the ramp gradient is fixed by the starting voltage and the ramp time – as soon as the selected current limit is reached. From this moment the voltage of the soft starter is controlled so that the current supplied to the motor remains constant. This process is ended either by completion of the motor ramp-up or by tripping by the intrinsic device protection or the motor overload protection. As the re-

sult of this function the actual motor ramp-up can well take longer than the ramp time selected on the soft starter.

Thanks to the integrated motor overload protection according to IEC 60947-4-2 there is no need of an additional overload relay on the new soft starters. The rated motor current, the setting of the overload tripping time (CLASS times) and the reset of the motor overload protection function can be adjusted easily and quickly. Using a 4-step rotary potentiometer it is possible to set different overload tripping times on the soft starter. In addition to CLASS 10, 15 and 20 it is also possible to switch off the motor overload protection if a different motor management control device is to be used for this function, e. g. with connection to PROFIBUS.

Device versions with thermistor motor protection evaluation are available up to a rating of 55 kW (at 400 V). A "Thermoclick" measuring probe can be connected directly, as can a PTC of type A. Thermal overloading of the motor, open circuits and short circuits in the sensor circuit all result in the direct disconnection of the soft starter. And if ever the soft starter trips, various reset options are available the same as with intrinsic device protection and motor load protection: manually with the reset button, automatically or remotely through brief disconnection of the control voltage.

The new series of devices comes with the "polarity balancing" control method, which is designed to prevent direct current components in two-phase controlled soft starters. On two-phase controlled soft starters the current resulting from superimposition of the two controlled phases flows in the uncontrolled phase. This results for physical reasons in an asymmetric distribution of the three phase currents during the motor ramp-up. This phenomenon cannot be influenced, but in most applications it is non-critical.

Controlling the power semiconductors results not only in this asymmetry, however, but also in the previously mentioned direct current components which can cause severe noise generation on the motor at starting voltages of less than 50 %.

The control method used for these soft starters eliminates these direct current components during the ramp-up phase and prevents the braking torque which they can cause. It creates a motor ramp-up that is uniform in speed, torque and current rise, thus permitting a particularly gentle, two-phase starting of the motors. At the same time the acoustic quality of the starting operation comes close to the quality of a three-phase controlled soft starter. This is made possible by the on-going dynamic harmonizing and balancing of current half-waves of different polarity during the motor ramp-up. Hence the name "polarity balancing".

Application

The SIRIUS 3RW40 solid-state soft starters are used for the soft starting and stopping of three-phase asynchronous motors.

Due to two-phase control, the current is kept at minimum values in all three phases throughout the entire starting time and disturbing direct current components are eliminated in addition. This not only enables the two-phase starting of motors up to 250 kW (at 400 V) but also avoids the current and torque peaks which occur e. g. with wye-delta starters.

Application areas

See "Selection aid for soft starters" on page 4/6.

SIRIUS 3RW Soft Starters

3RW30, 3RW40 for Standard Applications

3RW40

Technical specifications

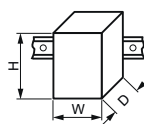
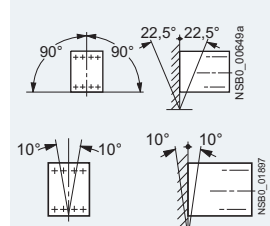
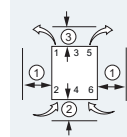
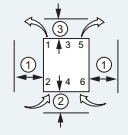
Type		3RW40 2.	3RW40 3.	3RW40 4.	3RW40 5.	3RW40 7.		
Mechanics and environment								
Mounting dimensions (WxHxD)								
<ul style="list-style-type: none"> Screw terminals Spring-type terminals 		mm	45 x 125 x 154	55 x 144 x 170	70 x 160 x 188	120 x 198 x 250	160 x 230 x 278	
		mm	45 x 150 x 154	55 x 144 x 170	70 x 160 x 188	120 x 198 x 250	160 x 230 x 278	
Permissible ambient temperature								
Operation	°C	-25 ... +60; (derating from +40)						
Storage	°C	-40 ... +80						
Weight								
	kg	0.77	1.35	1.9	4.9 (3RW40 55), 6.9 (3RW40 56)	8.9		
Permissible mounting position¹⁾								
<ul style="list-style-type: none"> With auxiliary fan (for 3RW40 2. ... 3RW40 4.) 								
	<ul style="list-style-type: none"> Without auxiliary fan (for 3RW40 2. ... 3RW40 4.) 	-- (fan integrated in the soft starter)						
Installation type¹⁾								
Stand-alone installation		3RW40 2.	 <ul style="list-style-type: none"> ① ≥ 15 mm (≥ 0.59 in) ② ≥ 40 mm (≥ 1.56 in) ③ ≥ 60 mm (≥ 2.36 in) 			3RW40 5., 3RW40 7.	<ul style="list-style-type: none"> ① ≥ 5 mm (≥ 0.2 in) ② ≥ 75 mm (≥ 3 in) ③ ≥ 100 mm (≥ 4 in) 	
		3RW40 3., 3RW40 4.	 <ul style="list-style-type: none"> ① ≥ 30 mm (≥ 1.18 in) ② ≥ 40 mm (≥ 1.56 in) ③ ≥ 60 mm (≥ 2.36 in) 					
Permissible installation altitude								
	m	5 000 (derating from 1000, see Characteristic curves page 4/7); higher on request						
Degree of protection								
		IP20	IP00					

¹⁾ In case of deviations, please note derating (see [Manual in Chapter "Configuration"](#)).

Type		3RW40 2. to 3RW40 4.		3RW40 5., 3RW40 7.	
Control electronics					
Rated values					
Rated control supply voltage	Terminal A1/A2	V	24 DC/AC	110 ... 230 AC/DC	115 AC 230 AC
• Tolerance		%	±20	-15/+10	-15/+10
Rated frequency		Hz	50/60		
• Tolerance		%	±10		
Power electronics					
Rated operational voltage					
Tolerance	V AC	200 ... 480	400 ... 600	200 ... 460	400 ... 600
	%	-15/+10	-15/+10	-15/+10	-15/+10
Maximum blocking voltage (thyristor)					
	V AC	1 600		1 400	1 800
Rated frequency					
Tolerance	Hz	50/60			
	%	±10			
Uninterrupted duty at 40 °C (% of I_e)					
	%	115			
Minimum load (% of minimum selectable rated motor current I_M)					
	%	20 (at least 2 A)			
Maximum cable length between soft starter and motor					
	m	300			

SIRIUS 3RW Soft Starters

3RW30, 3RW40 for Standard Applications

3RW40

Motor feeders with soft starters

The type of coordination to which the motor feeder with soft starter is mounted depends on the application-specific requirements. Normally, fuseless mounting (combination of motor starter protector/circuit breaker and soft starter) is sufficient.

If type of coordination "2" is to be fulfilled, semiconductor fuses must be fitted in the motor feeder.

T_{oC} 1

Type of coordination "1" according to IEC 60947-4-1: After a short-circuit incident the unit is defective therefore unsuitable for further use (protection of persons and equipment guaranteed).

T_{oC} 2

Type of coordination "2" according to IEC 60947-4-1: After a short-circuit incident the unit is suitable for further use (protection of persons and equipment guaranteed).

The type of coordination refers to soft starters in combination with the stipulated protective device (motor starter protector/circuit breaker/fuse), not to any additional components in the feeder.

The types of coordination are indicated in the corresponding tables by the symbols shown on orange backgrounds.

Fuseless version

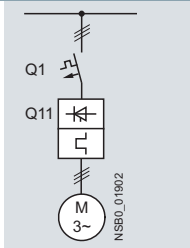

Soft starters	T _{oC} 1	Rated current A	Motor starter protectors/circuit breakers ¹⁾						
			400 V +10 %		400 V +10 %		575 V +10 %		
Q11 Type			Q1 Type	Q1 Type	I _{q max} kA	Rated current A	Q1 Type	I _{q max} kA	Rated current A
Type of coordination "1"									
3RW40 24		12.5	3RV20 21-4AA.. (S0)/ 3RV20 11-4AA.. (S00)	3RV23 21-4AC.. (S0)/ 3RV23 11-4AC.. (S00)	55	16	--	--	--
3RW40 26		25	3RV20 21-4DA..	3RV23 21-4DC..	55	25	--	--	--
3RW40 27		32	3RV20 21-4EA..	3RV23 21-4EC..	55	32	--	--	--
3RW40 28		38	3RV20 21-4FA..	3RV23 21-4FC..	55	40	--	--	--
3RW40 36		45	3RV10 31-4GA10	3RV13 31-4GC10	20	45	--	--	--
3RW40 37		63	3RV10 41-4JA10	3RV13 41-4JC10	20	63	--	--	--
3RW40 38		72	3RV10 41-4KA10	3RV13 41-4KC10	20	75	--	--	--
3RW40 46		80	3RV10 41-4LA10	3RV13 41-4LC10	11	90	--	--	--
3RW40 47		106	3RV10 41-4MA10	3RV13 41-4MC10	11	100	--	--	--
3RW40 55		134	3VL3 720-2DC36	--	35	200	3VL3 720-1DC36	12	200
3RW40 56		162	3VL3 720-2DC36	--	35	200	3VL3 720-1DC36	12	200
3RW40 73		230	3VL4 731-2DC36	--	65	315	3VL5 731-3DC36	35	315
3RW40 74		280	3VL4 731-2DC36	--	65	315	3VL5 731-3DC36	35	315
3RW40 75		356	3VL4 740-2DC36	--	65	400	3VL5 740-3DC36	35	400
3RW40 76		432	3VL5 750-2DC36	--	65	500	3VL5 750-3DC36	35	500

¹⁾ The rated motor current must be considered when selecting the devices. 3RV13 motor starter protectors are designed for starter combinations (without motor protection). Motor protection is provided in this case by the 3RW40 soft starter.

SIRIUS 3RW Soft Starters

3RW30, 3RW40 for Standard Applications

3RW40

Fused version (line protection only)

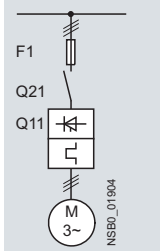

Soft starters	ToC 1	Rated current	Line fuses, maximum		Line contactors (optional)
Q11 Type	A	F1 Type	Rated current A	Size	Q21
Type of coordination "1"¹⁾: $I_q = 65 \text{ kA at } 600 \text{ V} + 5 \%$					
3RW40 24	12.5	3NA3 820-6	50	00	3RT10 24
3RW40 26	25	3NA3 822-6	63	00	3RT10 26
3RW40 27	32	3NA3 824-6	80	00	3RT10 34
3RW40 28	38	3NA3 824-6	80	00	3RT10 35
3RW40 36	45	3NA3 130-6	100	1	3RT10 36
3RW40 37	63	3NA3 132-6	125	1	3RT10 44
3RW40 38	72	3NA3 132-6	125	1	3RT10 45
3RW40 46	80	3NA3 136-6	160	1	3RT10 45
3RW40 47	106	3NA3 136-6	160	1	3RT10 46
3RW40 55	134	3NA3 244-6	250	2	3RT10 55-6A.36
3RW40 56	162	3NA3 244-6	250	2	3RT10 56-6A.36
3RW40 73	230	2 x 3NA3 354-6	2 x 355	3	3RT10 65-6A.36
3RW40 74	280	2 x 3NA3 354-6	2 x 355	3	3RT10 66-6A.36
3RW40 75	356	2 x 3NA3 365-6	2 x 500	3	3RT10 75-6A.36
3RW40 76	432	2 x 3NA3 365-6	2 x 500	3	3RT10 76-6A.36

¹⁾ The type of coordination "1" refers to soft starters in combination with the stipulated fuse, not to any additional components in the feeder.

Fused version with 3NE1 SITOR fuses (semiconductor and line protection)

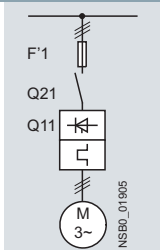

For matching fuse bases see Catalog LV 10.1

- "Switch Disconnectors"
- "Fuse Systems" --> "SITOR Semiconductor Fuses" or at www.siemens.com/sitor

Soft starters	ToC 2	Rated current	All-range fuses		Line contactors (optional)
Q11 Type	A	F1 Type	Rated current A	Size	Q21
Type of coordination "2"¹⁾: $I_q = 65 \text{ kA at } 600 \text{ V} + 5 \%$					
3RW40 24	12.5	3NE1 814-0	20	000	3RT10 24
3RW40 26	25	3NE1 803-0	35	000	3RT10 26
3RW40 27	32	3NE1 020-2	80	00	3RT10 34
3RW40 28	38	3NE1 020-2	80	00	3RT10 35
3RW40 36	45	3NE1 020-2	80	00	3RT10 36
3RW40 37	63	3NE1 820-0	80	000	3RT10 44
3RW40 38	72	3NE1 820-0	80	000	3RT10 45
3RW40 46	80	3NE1 021-0	100	00	3RT10 45
3RW40 47	106	3NE1 022-0	125	00	3RT10 46
3RW40 55	134	3NE1 227-2	250	1	3RT10 55-6A.36
3RW40 56	162	3NE1 227-2	250	1	3RT10 56-6A.36
3RW40 73	230	3NE1 331-2	350	2	3RT10 65-6A.36
3RW40 74	280	3NE1 333-2	450	2	3RT10 66-6A.36
3RW40 75	356	3NE1 334-2	500	2	3RT10 75-6A.36
3RW40 76	432	3NE1 435-2	560	3	3RT10 76-6A.36

¹⁾ The type of coordination "2" refers to soft starters in combination with the stipulated fuse, not to any additional components in the feeder.

SIRIUS 3RW Soft Starters

3RW30, 3RW40 for Standard Applications

3RW40

Fused version with 3NE3 SITOR fuses (semiconductor protection by fuse, line and overload protection by motor starter protector; alternatively, installation with contactor and overload relay possible)

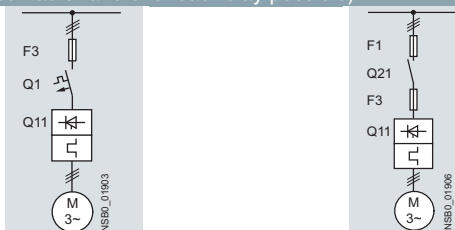

For matching fuse bases see Catalog LV 10.1

- "Switch Disconnectors"
- "Fuse Systems" --> "SITOR Semiconductor Fuses" or at www.siemens.com/sitor

Soft starters Q11 Type	ToC 2 Rated current A	Semiconductor fuses, minimum			Semiconductor fuses, maximum			Semiconductor fuses, minimum		
		F3 Type	Rated current A	Size	F3 Type	Rated current A	Size	F3 Type	Rated current A	Size
Type of coordination "2"¹⁾: I_q = 65 kA at 600 V + 5 %										
3RW40 24	12.5	--	--	--	--	--	--	3NE4 101	32	0
3RW40 26	25	--	--	--	3NE3 221	100	1	3NE4 102	40	0
3RW40 27	32	--	--	--	3NE3 224	160	1	3NE4 118	63	0
3RW40 28	38	--	--	--	3NE3 224	160	1	3NE4 118	63	0
3RW40 36	45	--	--	--	3NE3 224	160	1	3NE4 120	80	0
3RW40 37	63	--	--	--	3NE3 225	200	1	3NE4 121	100	0
3RW40 38	72	3NE3 221	100	1	3NE3 227	250	1	--	--	--
3RW40 46	80	3NE3 222	125	1	3NE3 225	200	1	--	--	--
3RW40 47	106	3NE3 224	160	1	3NE3 231	350	1	--	--	--
3RW40 55	134	3NE3 227	250	1	3NE3 335	560	2	--	--	--
3RW40 56	162	3NE3 227	250	1	3NE3 335	560	2	--	--	--
3RW40 73	230	3NE3 232-0B	400	1	3NE3 333	450	2	--	--	--
3RW40 74	280	3NE3 233	450	1	3NE3 336	630	2	--	--	--
3RW40 75	356	3NE3 335	560	2	3NE3 336	630	2	--	--	--
3RW40 76	432	3NE3 337-8	710	2	3NE3 340-8	900	2	--	--	--

Soft starters Q11 Type	ToC 2 Rated current A	Semiconductor fuses, max.			Semiconductor fuses, min.			Semiconductor fuses, max.			Cylindrical fuses	
		F3 Type	Rated current A	Size	F3 Type	Rated current A	Size	F3 Type	Rated current A	Size	F3 Type	Rated current A
Type of coordination "2"¹⁾: I_q = 65 kA at 600 V + 5 %												
3RW40 24	12.5	3NE4 117	50	0	3NE8 015-1	25	00	3NE8 017-1	50	00	3NC2 240	40
3RW40 26	25	3NE4 117	50	0	3NE8 017-1	50	00	3NE8 021-1	100	00	3NC2 263	63
3RW40 27	32	3NE4 118	63	0	3NE8 018-1	63	00	3NE8 022-1	125	00	3NC2 280	80
3RW40 28	38	3NE4 118	63	0	3NE8 020-1	80	00	3NE8 024-1	160	00	3NC2 280	80
3RW40 36	45	3NE4 120	80	0	3NE8 020-1	80	00	3NE8 024-1	160	00	3NC2 280	80
3RW40 37	63	3NE4 121	100	0	3NE8 021-1	100	00	3NE8 024-1	160	00	--	--
3RW40 38	72	--	--	--	3NE8 022-1	125	00	3NE8 024-1	160	00	--	--
3RW40 46	80	--	--	--	3NE8 022-1	125	00	3NE8 024-1	160	00	--	--
3RW40 47	106	--	--	--	3NE8 024-1	160	00	3NE8 024-1	160	00	--	--
3RW40 55	134	--	--	--	--	--	--	--	--	--	--	--
3RW40 56	162	--	--	--	--	--	--	--	--	--	--	--
3RW40 73	230	--	--	--	--	--	--	--	--	--	--	--
3RW40 74	280	--	--	--	--	--	--	--	--	--	--	--
3RW40 75	356	--	--	--	--	--	--	--	--	--	--	--
3RW40 76	432	--	--	--	--	--	--	--	--	--	--	--

Soft starters Q11 Type	ToC 2 Rated current A	Line contactors (optional) Q21	Motor starter protectors/circuit breakers				Line fuses, maximum			
			400 V +10 % Q1 Type	Rated current A	575 V +10 % Q1 Type	Rated current A	F1 Type	Rated current A	Size	
Type of coordination "2"¹⁾: I_q = 65 kA at 600 V + 5 %										
3RW40 24	12.5	3RT10 24	3RV20 21-4AA.. (S0)/ 3RV20 11-4AA.. (S00)	55	--	--	--	3NA3 820-6	50	00
3RW40 26	25	3RT10 26	3RV20 21-4DA..	55	--	--	--	3NA3 822-6	63	00
3RW40 27	32	3RT10 34	3RV20 21-4EA..	55	--	--	--	3NA3 824-6	80	00
3RW40 28	38	3RT10 35	3RV20 21-4FA..	55	--	--	--	3NA3 824-6	80	00
3RW40 36	45	3RT10 36	3RV10 31-4GA10	20	--	--	--	3NA3 130-6	100	1
3RW40 37	63	3RT10 44	3RV10 41-4JA10	20	--	--	--	3NA3 132-6	125	1
3RW40 38	72	3RT10 45	3RV10 41-4KA10	20	--	--	--	3NA3 132-6	125	1
3RW40 46	80	3RT10 45	3RV10 41-4LA10	11	--	--	--	3NA3 136-6	160	1
3RW40 47	106	3RT10 46	3RV10 41-4MA10	11	--	--	--	3NA3 136-6	160	1
3RW40 55	134	3RT10 55-6A.36	3VL3 720	200	3VL3 720	200	3NA3 244-6	250	2	2
3RW40 56	162	3RT10 56-6A.36	3VL3 720	200	3VL3 720	200	3NA3 244-6	250	2	2
3RW40 73	230	3RT10 65-6A.36	3VL4 731	315	3VL5 731	315	2 x 3NA3 354-6	2 x 355	3	3
3RW40 74	280	3RT10 66-6A.36	3VL4 731	315	3VL5 731	315	2 x 3NA3 354-6	2 x 355	3	3
3RW40 75	356	3RT10 75-6A.36	3VL4 740	400	3VL5 740	400	2 x 3NA3 365-6	2 x 500	3	3
3RW40 76	432	3RT10 76-6A.36	3VL5 750	500	3VL5 750	500	2 x 3NA3 365-6	2 x 500	3	3

¹⁾ The type of coordination "2" refers to soft starters in combination with the stipulated protective device (motor starter protector/circuit breaker/fuse), not to any additional components in the feeder.

SIRIUS 3RW Soft Starters

3RW30, 3RW40 for Standard Applications

3RW40

Selection and ordering data

SIRIUS 3RW40 for normal starting (CLASS 10)



3RW40 2.



3RW40 3.



3RW40 4.

3RW ambient temperature 40 °C ¹⁾				3RW ambient temperature 50 °C ¹⁾				Size	DT	Normal starting (CLASS 10)	PU (UNIT, SET, M)	PS*	PG	
Rated values of induction motors				Rated values of induction motors										
Operational current I _e	Rating at operational voltage U _e			Operational current I _e	Rating at operational voltage U _e			Order No.	Price per PU					
	230 V	400 V	500 V		200 V	230 V	460 V						575 V	
A	kW	kW	kW	A	hp	hp	hp	hp						
Rated operational voltage U_e 200 ... 480 V²⁾														
• With screw terminals														
12.5	3	5.5	--	11	3	3	7.5	--	S0	▶	3RW40 24-1BB□4	1	1 unit	131
25	5.5	11	--	23	5	5	15	--	S0	▶	3RW40 26-1BB□4	1	1 unit	131
32	7.5	15	--	29	7.5	7.5	20	--	S0	▶	3RW40 27-1BB□4	1	1 unit	131
38	11	18.5	--	34	10	10	25	--	S0	▶	3RW40 28-1BB□4	1	1 unit	131
• With spring-type terminals														
12.5	3	5.5	--	11	3	3	7.5	--	S0	B	3RW40 24-2BB□4	1	1 unit	131
25	5.5	11	--	23	5	5	15	--	S0	B	3RW40 26-2BB□4	1	1 unit	131
32	7.5	15	--	29	7.5	7.5	20	--	S0	B	3RW40 27-2BB□4	1	1 unit	131
38	11	18.5	--	34	10	10	25	--	S0	B	3RW40 28-2BB□4	1	1 unit	131
• With screw or spring-type terminals														
45	11	22	--	42	10	15	30	--	S2	▶	3RW40 36-□BB□4	1	1 unit	131
63	18.5	30	--	58	15	20	40	--	S2	▶	3RW40 37-□BB□4	1	1 unit	131
72	22	37	--	62	20	20	40	--	S2	▶	3RW40 38-□BB□4	1	1 unit	131
• With screw or spring-type terminals														
80	22	45	--	73	20	25	50	--	S3	▶	3RW40 46-□BB□4	1	1 unit	131
106	30	55	--	98	30	30	75	--	S3	▶	3RW40 47-□BB□4	1	1 unit	131
Rated operational voltage U_e 400 ... 600 V														
• With screw terminals														
12.5	--	5.5	7.5	11	--	--	7.5	10	S0	B	3RW40 24-1BB□5	1	1 unit	131
25	--	11	15	23	--	--	15	20	S0	B	3RW40 26-1BB□5	1	1 unit	131
32	--	15	18.5	29	--	--	20	25	S0	B	3RW40 27-1BB□5	1	1 unit	131
38	--	18.5	22	34	--	--	25	30	S0	B	3RW40 28-1BB□5	1	1 unit	131
• With spring-type terminals														
12.5	--	5.5	7.5	11	--	--	7.5	10	S0	B	3RW40 24-2BB□5	1	1 unit	131
25	--	11	15	23	--	--	15	20	S0	B	3RW40 26-2BB□5	1	1 unit	131
32	--	15	18.5	29	--	--	20	25	S0	B	3RW40 27-2BB□5	1	1 unit	131
38	--	18.5	22	34	--	--	25	30	S0	B	3RW40 28-2BB□5	1	1 unit	131
• With screw or spring-type terminals														
45	--	22	30	42	--	--	30	40	S2	B	3RW40 36-□BB□5	1	1 unit	131
63	--	30	37	58	--	--	40	50	S2	B	3RW40 37-□BB□5	1	1 unit	131
72	--	37	45	62	--	--	40	60	S2	B	3RW40 38-□BB□5	1	1 unit	131
• With screw or spring-type terminals														
80	--	45	55	73	--	--	50	60	S3	B	3RW40 46-□BB□5	1	1 unit	131
106	--	55	75	98	--	--	75	75	S3	B	3RW40 47-□BB□5	1	1 unit	131

Order No. supplement for connection types

- With screw terminals
- With spring-type terminals³⁾

Order No. supplement for rated control supply voltage U_c

- 24 V AC/DC
- 110 ... 230 V AC/DC

¹⁾ Stand-alone installation without auxiliary fan.

²⁾ Soft starter with screw terminals: delivery time class ▶ (preferred type).

³⁾ Main circuit connection: screw terminals.

Note:

The listed motor ratings are rough guide values. The soft starter should always be designed on the basis of the required rated operational current of the motor. The 3RW40 soft starters are designed for easy starting conditions. The selection and ordering data were determined for the following boundary conditions (see also the notes on page 4/6):

- Maximum starting time in s: 10
- Maximum starting current in % of motor current I_e: 300
- Maximum number of starts per hour in 1/h: 5

Switching frequency can be increased by means of auxiliary fans.

* You can order this quantity or a multiple thereof. Illustrations are approximate

SIRIUS 3RW Soft Starters

3RW30, 3RW40 for Standard Applications

3RW40



3RW40 2.



3RW40 3.



3RW40 4.

3RW ambient temperature 40 °C ¹⁾				3RW ambient temperature 50 °C ¹⁾				Size	DT	Normal starting (CLASS 10)	PU (UNIT, SET, M)	PS*	PG	
Rated values of induction motors		Rated values of induction motors		Operational current I _e		Rating at operational voltage U _e								Operational current I _e
Operational current I _e	Rating at operational voltage U _e		Operational current I _e	Rating at operational voltage U _e		200 V	230 V	460 V	575 V	Order No.	Price per PU			
	230 V	400 V		500 V	200 V							230 V	460 V	575 V
Rated operational voltage U_e 200 ... 480 V²⁾, with thermistor motor protection, rated control supply voltage U_s 24 V AC/DC														
• With screw terminals														
12.5	3	5.5	--	11	3	3	7.5	--	S0	▶	3RW40 24-1TB04	1	1 unit	131
25	5.5	11	--	23	5	5	15	--	S0	▶	3RW40 26-1TB04	1	1 unit	131
32	7.5	15	--	29	7.5	7.5	20	--	S0	▶	3RW40 27-1TB04	1	1 unit	131
38	11	18.5	--	34	10	10	25	--	S0	▶	3RW40 28-1TB04	1	1 unit	131
• With spring-type terminals														
12.5	3	5.5	--	11	3	3	7.5	--	S0	B	3RW40 24-2TB04	1	1 unit	131
25	5.5	11	--	23	5	5	15	--	S0	B	3RW40 26-2TB04	1	1 unit	131
32	7.5	15	--	29	7.5	7.5	20	--	S0	B	3RW40 27-2TB04	1	1 unit	131
38	11	18.5	--	34	10	10	25	--	S0	B	3RW40 28-2TB04	1	1 unit	131
• With screw or spring-type terminals														
45	11	22	--	42	10	15	30	--	S2	▶	3RW40 36-□TB04	1	1 unit	131
63	18.5	30	--	58	15	20	40	--	S2	▶	3RW40 37-□TB04	1	1 unit	131
72	22	37	--	62	20	20	40	--	S2	▶	3RW40 38-□TB04	1	1 unit	131
• With screw or spring-type terminals														
80	22	45	--	73	20	25	50	--	S3	▶	3RW40 46-□TB04	1	1 unit	131
106	30	55	--	98	30	30	75	--	S3	▶	3RW40 47-□TB04	1	1 unit	131
Rated operational voltage U_e 400 ... 600 V, with thermistor motor protection, rated control supply voltage U_s 24 V AC/DC														
• With screw terminals														
12.5	--	5.5	7.5	11	--	--	7.5	10	S0	B	3RW40 24-1TB05	1	1 unit	131
25	--	11	15	23	--	--	15	20	S0	B	3RW40 26-1TB05	1	1 unit	131
32	--	15	18.5	29	--	--	20	25	S0	B	3RW40 27-1TB05	1	1 unit	131
38	--	18.5	22	34	--	--	25	30	S0	B	3RW40 28-1TB05	1	1 unit	131
• With spring-type terminals														
12.5	--	5.5	7.5	11	--	--	7.5	10	S0	B	3RW40 24-2TB05	1	1 unit	131
25	--	11	15	23	--	--	15	20	S0	B	3RW40 26-2TB05	1	1 unit	131
32	--	15	18.5	29	--	--	20	25	S0	B	3RW40 27-2TB05	1	1 unit	131
38	--	18.5	22	34	--	--	25	30	S0	B	3RW40 28-2TB05	1	1 unit	131
• With screw or spring-type terminals														
45	--	22	30	42	--	--	30	40	S2	B	3RW40 36-□TB05	1	1 unit	131
63	--	30	37	58	--	--	40	50	S2	B	3RW40 37-□TB05	1	1 unit	131
72	--	37	45	62	--	--	40	60	S2	B	3RW40 38-□TB05	1	1 unit	131
• With screw or spring-type terminals														
80	--	45	55	73	--	--	50	60	S3	B	3RW40 46-□TB05	1	1 unit	131
106	--	55	75	98	--	--	75	75	S3	B	3RW40 47-□TB05	1	1 unit	131

Order No. supplement for connection types

- With screw terminals
- With spring-type terminals³⁾

¹⁾ Stand-alone installation without auxiliary fan.

²⁾ Soft starter with screw terminals: delivery time class ▶ (preferred type).

³⁾ Main circuit connection: screw terminals.

Note:

The listed motor ratings are rough guide values. The soft starter should always be designed on the basis of the required rated operational current of the motor. The 3RW40 soft starters are designed for easy starting conditions.

The selection and ordering data were determined for the following boundary conditions (see also the notes on page 4/6):

- Maximum starting time in s: 10
- Maximum starting current in % of motor current I_e: 300
- Maximum number of starts per hour in 1/h: 5

Switching frequency can be increased by means of auxiliary fans.

1

2

SIRIUS 3RW Soft Starters

3RW30, 3RW40 for Standard Applications

3RW40



3RW40 5.



3RW40 7.

3RW ambient temperature 40 °C ¹⁾				3RW ambient temperature 50 °C ¹⁾				Size	DT	Normal starting (CLASS 10)	PU (UNIT, SET, M)	PS*	PG	
Rated values of induction motors				Rated values of induction motors										
Operational current I _e	Rating at operational voltage U _e			Operational current I _e	Rating at operational voltage U _e			Order No.	Price per PU					
	230 V	400 V	500 V		200 V	230 V	460 V			575 V				
A	kW	kW	kW	A	hp	hp	hp	hp						
Rated operational voltage U_e 200 ... 460 V²⁾														
• With screw or spring-type terminals														
134	37	75	--	117	30	40	75	--	S6	B	3RW40 55-□BB□4	1	1 unit	131
162	45	90	--	145	40	50	100	--	S6	B	3RW40 56-□BB□4	1	1 unit	131
• With screw or spring-type terminals														
230	75	132	--	205	60	75	150	--	S12	B	3RW40 73-□BB□4	1	1 unit	131
280	90	160	--	248	75	100	200	--	S12	B	3RW40 74-□BB□4	1	1 unit	131
356	110	200	--	315	100	125	250	--	S12	B	3RW40 75-□BB□4	1	1 unit	131
432	132	250	--	385	125	150	300	--	S12	B	3RW40 76-□BB□4	1	1 unit	131
Rated operational voltage U_e 400 ... 600 V³⁾														
• With screw or spring-type terminals														
134	--	75	90	117	--	--	75	100	S6	B	3RW40 55-□BB□5	1	1 unit	131
162	--	90	110	145	--	--	100	150	S6	B	3RW40 56-□BB□5	1	1 unit	131
• With screw or spring-type terminals														
230	--	132	160	205	--	--	150	200	S12	B	3RW40 73-□BB□5	1	1 unit	131
280	--	160	200	248	--	--	200	250	S12	B	3RW40 74-□BB□5	1	1 unit	131
356	--	200	250	315	--	--	250	300	S12	B	3RW40 75-□BB□5	1	1 unit	131
432	--	250	315	385	--	--	300	400	S12	B	3RW40 76-□BB□5	1	1 unit	131

Order No. supplement for connection types⁴⁾

- With spring-type terminals
- With screw terminals

Order No. supplement for the rated control supply voltage U_s⁵⁾

- 115 V AC
- 230 V AC

2
6
3
4

¹⁾ Stand-alone installation.

²⁾ Soft starter with screw terminals: delivery time class ▶ (preferred type).

³⁾ Soft starter with screw terminals: delivery time class A.

⁴⁾ Main circuit connection: busbar connection.

⁵⁾ Control by way of the internal 24 V DC supply and direct control by means of PLC possible.

Note:

The listed motor ratings are rough guide values. The soft starter should always be designed on the basis of the required rated operational current of the motor.

The 3RW40 solid-state soft starters are designed for easy starting conditions. The selection and ordering data were determined for the following boundary conditions (see also the notes on page 4/6):

- Maximum starting time in s: 10
- Maximum starting current in % of motor current I_e: 300
- Maximum number of starts per hour in 1/h: 5

In the event of more exacting requirements, it may be necessary to choose a larger device. However, in some cases the de-signed-in safety reserves also permit the listed units to be used in boundary conditions which are slightly more demanding. Detailed technical information for a configuration which is tailored exactly to the application can be found in the manuals. Siemens recommends the use of the selection and simulation program Win-Soft Starter.

SIRIUS 3RW Soft Starters

3RW30, 3RW40 for Standard Applications

3RW40

SIRIUS 3RW40 for heavy starting (CLASS 20)



3RW40 2.

3RW40 3.

3RW40 4.

3RW ambient temperature 40 °C ¹⁾				3RW ambient temperature 50 °C ¹⁾				Size	DT	Heavy starting (CLASS 20)	PU (UNIT, SET, M)	PS*	PG	
Rated values of induction motors		Rated values of induction motors		Rated values of induction motors		Rated values of induction motors								
Operational current I_e	Rating at operational voltage U_e			Operational current I_e	Rating at operational voltage U_e			Order No.	Price per PU					
	230 V	400 V	500 V		200 V	230 V	460 V						575 V	
A	kW	kW	kW	A	hp	hp	hp	hp						
Rated operational voltage U_e 200 ... 480 V²⁾														
• With screw terminals														
12.5	3	5.5	--	11	3	3	7.5	--	S0	▶	3RW40 26-1BB□4	1	1 unit	131
25	5.5	11	--	23	5	5	15	--	S0	▶	3RW40 27-1BB□4	1	1 unit	131
• With spring-type terminals														
12.5	3	5.5	--	11	3	3	7.5	--	S0	B	3RW40 26-2BB□4	1	1 unit	131
25	5.5	11	--	23	5	5	15	--	S0	B	3RW40 27-2BB□4	1	1 unit	131
• With screw or spring-type terminals														
32	7.5	15	--	29	7.5	7.5	20	--	S2	▶	3RW40 36-□BB□4	1	1 unit	131
38	11	18.5	--	34	10	10	25	--	S2	▶	3RW40 37-□BB□4	1	1 unit	131
45	11	22	--	42	10	15	30	--	S2	▶	3RW40 37-□BB□4	1	1 unit	131
63	18.5	30	--	58	15	20	40	--	S3	▶	3RW40 47-□BB□4	1	1 unit	131
72	22	37	--	62	20	20	40	--	S3	▶	3RW40 47-□BB□4	1	1 unit	131
Rated operational voltage U_e 400 ... 600 V														
• With screw terminals														
12.5	--	5.5	7.5	11	--	--	7.5	10	S0	B	3RW40 26-1BB□5	1	1 unit	131
25	--	11	15	23	--	--	15	20	S0	B	3RW40 27-1BB□5	1	1 unit	131
• With spring-type terminals														
12.5	--	5.5	7.5	11	--	--	7.5	10	S0	B	3RW40 26-2BB□5	1	1 unit	131
25	--	11	15	23	--	--	15	20	S0	B	3RW40 27-2BB□5	1	1 unit	131
• With screw or spring-type terminals														
32	--	15	18.5	29	--	--	20	25	S2	B	3RW40 36-□BB□5	1	1 unit	131
38	--	18.5	22	34	--	--	25	30	S2	B	3RW40 37-□BB□5	1	1 unit	131
45	--	22	30	42	--	--	30	40	S2	B	3RW40 37-□BB□5	1	1 unit	131
63	--	30	37	58	--	--	40	50	S3	B	3RW40 47-□BB□5	1	1 unit	131
72	--	37	45	62	--	--	40	60	S3	B	3RW40 47-□BB□5	1	1 unit	131

Order No. supplement for connection types

- With screw terminals
- With spring-type terminals³⁾

Order No. supplement for rated control supply voltage U_c

- 24 V AC/DC
- 110 ... 230 V AC/DC

¹⁾ Stand-alone installation without auxiliary fan.

²⁾ Soft starter with screw terminals: delivery time class ▶ (preferred type).

³⁾ Main circuit connection: screw terminals.

Note:

The listed motor ratings are rough guide values. The soft starter should always be designed on the basis of the required rated operational current of the motor.

The 3RW40 solid-state soft starters are designed for easy starting conditions. The selection and ordering data were determined for the following boundary conditions (see also the notes on page 4/6):

- Maximum starting time in s: 20
- Maximum starting current in % of motor current I_e : 300
- Maximum number of starts per hour in 1/h: 5

Switching frequency can be increased by means of auxiliary fans.

In the event of more exacting requirements, it may be necessary to choose a larger device. However, in some cases the designed-in safety reserves also permit the listed units to be used in boundary conditions which are slightly more demanding. Detailed technical information for a configuration which is tailored exactly to the application can be found in the manuals. Siemens recommends the use of the selection and simulation program Win-Soft Starter.



SIRIUS 3RW Soft Starters

3RW30, 3RW40 for Standard Applications

3RW40



3RW40 2.



3RW40 3.



3RW40 4.

3RW ambient temperature 40 °C ¹⁾				3RW ambient temperature 50 °C ¹⁾				Size	DT	Heavy starting (CLASS 20)	PU (UNIT, SET, M)	PS*	PG
Rated values of induction motors				Rated values of induction motors									
Operational current I _e	Rating at operational voltage U _e			Operational current I _e	Rating at operational voltage U _e					Order No.	Price per PU		
	230 V	400 V	500 V		200 V	230 V	460 V	575 V	A				
A	kW	kW	kW	A	hp	hp	hp	hp					
Rated operational voltage U_e 200 ... 480 V²⁾, with thermistor motor protection, rated control supply voltage U_s 24 V AC/DC													
• With screw terminals													
12.5	3	5.5	--	11	3	3	7.5	--	S0	▶	3RW40 26-1TB04	1	1 unit 131
25	5.5	11	--	23	5	5	15	--	S0	▶	3RW40 27-1TB04	1	1 unit 131
• With spring-type terminals													
12.5	3	5.5	--	11	3	3	7.5	--	S0	B	3RW40 26-2TB04	1	1 unit 131
25	5.5	11	--	23	5	5	15	--	S0	B	3RW40 27-2TB04	1	1 unit 131
• With screw or spring-type terminals													
32	7.5	15	--	29	7.5	7.5	20	--	S2	▶	3RW40 36-□TB04	1	1 unit 131
38	11	18.5	--	34	10	10	25	--	S2	▶	3RW40 37-□TB04	1	1 unit 131
45	11	22	--	42	10	15	30	--	S2	▶	3RW40 37-□TB04	1	1 unit 131
63	18.5	30	--	58	15	20	40	--	S3	▶	3RW40 47-□TB04	1	1 unit 131
72	22	37	--	62	20	20	40	--	S3	▶	3RW40 47-□TB04	1	1 unit 131
Rated operational voltage U_e 400 ... 600 V, with thermistor motor protection, rated control supply voltage U_s 24 V AC/DC													
• With screw terminals													
12.5	--	5.5	7.5	11	--	--	7.5	10	S0	B	3RW40 26-1TB05	1	1 unit 131
25	--	11	15	23	--	--	15	20	S0	B	3RW40 27-1TB05	1	1 unit 131
• With spring-type terminals													
12.5	--	5.5	7.5	11	--	--	7.5	10	S0	B	3RW40 26-2TB05	1	1 unit 131
25	--	11	15	23	--	--	15	20	S0	B	3RW40 27-2TB05	1	1 unit 131
• With screw or spring-type terminals													
32	--	15	18.5	29	--	--	20	25	S2	B	3RW40 36-□TB05	1	1 unit 131
38	--	18.5	22	34	--	--	25	30	S2	B	3RW40 37-□TB05	1	1 unit 131
45	--	22	30	42	--	--	30	40	S2	B	3RW40 37-□TB05	1	1 unit 131
63	--	30	37	58	--	--	40	50	S3	B	3RW40 47-□TB05	1	1 unit 131
72	--	37	45	62	--	--	40	60	S3	B	3RW40 47-□TB05	1	1 unit 131

Order No. supplement for connection types

- With screw terminals
- With spring-type terminals³⁾

¹⁾ Stand-alone installation without auxiliary fan.

²⁾ Soft starter with screw terminals: delivery time class ▶ (preferred type).

Note:

The listed motor ratings are rough guide values. The soft starter should always be designed on the basis of the required rated operational current of the motor.

The 3RW40 solid-state soft starters are designed for easy starting conditions. The selection and ordering data were determined for the following boundary conditions (see also the notes on page 4/6):

- Maximum starting time in s: 20
- Maximum starting current in % of motor current I_e: 300
- Maximum number of starts per hour in 1/h: 5

Switching frequency can be increased by means of auxiliary fans.

³⁾ Main circuit connection: screw terminals.

In the event of more exacting requirements, it may be necessary to choose a larger device. However, in some cases the designed-in safety reserves also permit the listed units to be used in boundary conditions which are slightly more demanding. Detailed technical information for a configuration which is tailored exactly to the application can be found in the manuals. Siemens recommends the use of the selection and simulation program Win-Soft Starter.

SIRIUS 3RW Soft Starters

3RW30, 3RW40 for Standard Applications

3RW40



3RW40 5.



3RW40 7.

3RW ambient temperature 40 °C ¹⁾				3RW ambient temperature 50 °C ¹⁾				Size	DT	Heavy starting (CLASS 20)	PU (UNIT, SET, M)	PS*	PG	
Rated values of induction motors				Rated values of induction motors										
Operational current I _e	Rating at operational voltage U _e			Operational current I _e	Rating at operational voltage U _e			Order No.	Price per PU					
	230 V	400 V	500 V		200 V	230 V	460 V			575 V				
A	kW	kW	kW	A	hp	hp	hp	hp						
Rated operational voltage U_e 200 ... 460 V²⁾														
• With screw or spring-type terminals														
80	22	45	--	73	20	25	50	--	S6	B	3RW40 55-□BB□4	1	1 unit	131
106	30	55	--	98	25	30	60	--	S6	B	3RW40 55-□BB□4	1	1 unit	131
134	37	75	--	117	30	40	75	--	S6	B	3RW40 56-□BB□4	1	1 unit	131
162	45	90	--	145	40	50	100	--	S12	B	3RW40 73-□BB□4	1	1 unit	131
230	75	132	--	205	60	75	150	--	S12	B	3RW40 74-□BB□4	1	1 unit	131
280	90	160	--	248	75	100	200	--	S12	B	3RW40 75-□BB□4	1	1 unit	131
356	110	200	--	315	100	125	250	--	S12	B	3RW40 76-□BB□4	1	1 unit	131
Rated operational voltage U_e 400 ... 600 V³⁾														
• With screw or spring-type terminals														
80	--	45	55	73	--	--	50	60	S6	B	3RW40 55-□BB□5	1	1 unit	131
106	--	55	75	98	--	--	60	75	S6	B	3RW40 55-□BB□5	1	1 unit	131
134	--	75	90	117	--	--	75	100	S6	B	3RW40 56-□BB□5	1	1 unit	131
162	--	90	110	145	--	--	100	150	S12	B	3RW40 73-□BB□5	1	1 unit	131
230	--	132	160	205	--	--	150	200	S12	B	3RW40 74-□BB□5	1	1 unit	131
280	--	160	200	248	--	--	200	250	S12	B	3RW40 75-□BB□5	1	1 unit	131
356	--	200	250	315	--	--	250	300	S12	B	3RW40 76-□BB□5	1	1 unit	131
Order No. supplement for connection types⁴⁾														
• With spring-type terminals														
• With screw terminals														
Order No. supplement for the rated control supply voltage U_s⁵⁾														
• 115 V AC														
• 230 V AC														

1) Stand-alone installation.
 2) Soft starter with screw terminals: delivery time class ▶ (preferred type).
 3) Soft starter with screw terminals: delivery time class A.

4) Main circuit connection: busbar connection.
 5) Control by way of the internal 24 V DC supply and direct control by means of PLC possible.

Note:

The listed motor ratings are rough guide values. The soft starter should always be designed on the basis of the required rated operational current of the motor.

The 3RW40 solid-state soft starters are designed for easy starting conditions. The selection and ordering data were determined for the following boundary conditions (see also the notes on page 4/6):

- Maximum starting time in s: 40
- Maximum starting current in % of motor current I_e: 350
- Maximum number of starts per hour in 1/h: 1

In the event of more exacting requirements, it may be necessary to choose a larger device. However, in some cases the designed-in safety reserves also permit the listed units to be used in boundary conditions which are slightly more demanding. Detailed technical information for a configuration which is tailored exactly to the application can be found in the manuals. Siemens recommends the use of the selection and simulation program Win-Soft Starter.

SIRIUS 3RW Soft Starters

3RW30, 3RW40 for Standard Applications

3RW40

Accessories

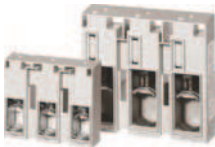

Conductor cross-section		Tightening torque	For soft starters size	DT	Order No.	Price per PU	PU (UNIT, SET, M)	PS*	PG	
Solid or stranded	Finely stranded with end sleeve									AWG cables, solid or stranded
mm ²	mm ²	AWG	Nm							
Three-phase feeder terminals										
										
2.5 ... 16	2.5 ... 16	10 ... 4	3 ... 4	S0 (3RW40 2.)	A	3RV29 25-5AB	1	1 unit	101	
Box terminal blocks for soft starters										
For soft starters Type		Version Size			DT	Order No.	Price per PU	PU (UNIT, SET, M)	PS*	PG
										
For round and ribbon cables (2 units required for each device)										
3RW40 5.	S6	<ul style="list-style-type: none"> Up to 70 mm² Up to 120 mm² 			▶	3RT19 55-4G		1	1 unit	101
					▶	3RT19 56-4G		1	1 unit	101
Auxiliary conductor connection for box terminals										
3RW40 7.	S12	Up to 240 mm ² (with auxiliary conductor connection)			▶	3RT19 66-4G		1	1 unit	101
Auxiliary terminals										
Auxiliary terminals, 3-pole										
3RW40 4.	S3				B	3RT19 46-4F		1	1 unit	101
Covers for soft starters										
Terminal covers for box terminals										
Additional touch protection to be fitted at the box terminals (2 units required per device)										
3RW40 3.	S2				▶	3RT19 36-4EA2		1	1 unit	101
3RW40 4.	S3				▶	3RT19 46-4EA2		1	1 unit	101
3RW40 5.	S6				▶	3RT19 56-4EA2		1	1 unit	101
3RW40 7.	S12				▶	3RT19 66-4EA2		1	1 unit	101
Terminal covers for cable lugs and busbar connections										
3RW40 4.	S3	For complying with the phase clearances and as touch protection if box terminal is removed			▶	3RT19 46-4EA1		1	1 unit	101
3RW40 5.	S6				▶	3RT19 56-4EA1		1	1 unit	101
3RW40 7.	S12				▶	3RT19 66-4EA1		1	1 unit	101
Also fits in case of S6 and S12 on mounted box terminals										
Sealing covers										
3RW40 2.	S0				▶	3RW49 00-0PB10		1	1 unit	131
3RW40 3.	S2									
3RW40 4.	S3									
3RW40 5.	S6				▶	3RW49 00-0PB00		1	1 unit	131
3RW40 7.	S12									

* You can order this quantity or a multiple thereof.
Illustrations are approximate



SIRIUS 3RW Soft Starters

3RW30, 3RW40 for Standard Applications

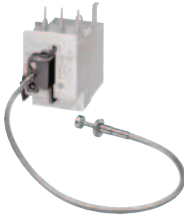
3RW40

For soft starters		Version	DT	Order No.	Price per PU	PU (UNIT, SET, M)	PS*	PG
Type	Size							
Modules for RESET¹⁾								
Modules for remote RESET, electrical								
Operating range 0.85 ... 1.1 x U _s , power consumption AC 80 VA, DC 70 W, ON period 0.2 ... 4 s, switching frequency 60/h								
	3RW40 5.	S6	• 24 ... 30 V AC/DC	▶	3RU19 00-2AB71	1	1 unit	101
	3RW40 7.	S12	• 110 ... 127 V AC/DC	▶	3RU19 00-2AF71	1	1 unit	101
			• 220 ... 250 V AC/DC	▶	3RU19 00-2AM71	1	1 unit	101
Mechanical RESET comprising								
	3RW40 5.	S6	• Resetting plungers, holders and formers	▶	3RU19 00-1A	1	1 unit	101
	3RW40 7.	S12	• Suitable pushbutton IP65, Ø 22 mm, 12 mm stroke	B	3SB30 00-0EA11	1	1 unit	102
			• Extension plungers	A	3SX13 35	1	1 unit	102
Cable releases with holder for RESET								
For Ø 6.5 mm holes in the control panel; max. control panel thickness 8 mm								
	3RW40 5.	S6	• Length 400 mm	▶	3RU19 00-1B	1	1 unit	101
	3RW40 7.	S12	• Length 600 mm	▶	3RU19 00-1C	1	1 unit	101

¹⁾ Remote RESET already integrated in the 3RW40 2. to 3RW40 4. soft starters.

For soft starters		Version	DT	Order No.	Price per PU	PU (UNIT, SET, M)	PS*	PG
Type	Size							
Fans (to increase switching frequency and for device mounting in positions different from the normal position)								
	3RW40 2.	S0		▶	3RW49 28-8VB00	1	1 unit	131
	3RW40 3.	S2		▶	3RW49 47-8VB00	1	1 unit	131
	3RW40 4.	S3						
Manuels 3RW30/3RW40¹⁾								
	3RW40 2.	S0		C	3ZX10 12-0RW30-1AB1	1	1 unit	191
	3RW40 3.	S2						
	3RW40 4.	S3						
	3RW40 5.	S6						
	3RW40 7.	S12						
Operating instructions¹⁾								
	3RW40 2.	S0			3ZX10 12-0RW40-1AA1			
	3RW40 3.	S2						
	3RW40 4.	S3						
	3RW40 5.	S6			3ZX10 12-0RW40-2DA1			
	3RW40 7.	S12						

¹⁾ The operating instructions are included in the scope of supply of the soft starter or are available – like the manual – as a PDF download from the Service&Support portal at www.siemens.com/industrial-controls/support --> Controls --> Soft Starters and Solid-State Switching Devices --> SIRIUS 3RW Soft Starters.



SIRIUS 3RW Soft Starters

3RW30, 3RW40 for Standard Applications

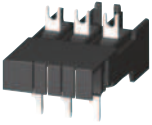
3RW40

For soft starters		Motor starter protectors		DT	Order No.	Price per PU	PU (UNIT, SET, M)	PS*	PG
Type	Size	Size	Size						
Link modules to motor starter protectors¹⁾									
	<ul style="list-style-type: none"> With screw terminals 								
	3RW40 2.	S0	S00/S0	A	3RA29 21-1BA00		1	1 unit	101
	3RW40 36.	S2	S2	▶	3RA19 31-1AA00		1	1 unit	101
	3RW40 46., 3RW40 47.	S3	S3	▶	3RA19 41-1AA00		1	1 unit	101
	<ul style="list-style-type: none"> With spring-type terminals 								
3RW40 2.	S0	S0	A	3RA29 21-2GA00		1	1 unit	101	

¹⁾ Can be used in size S0 up to maximum 32 A.
Can be used in size S0 only for 3RV2 motor starter protectors.

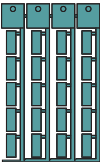
Version	DT	Order No.	Price per PU	PU (UNIT, SET, M)	PS*	PG
Tools for opening spring-type terminals for sizes S00 and S0						
	A	Spring-type terminals 		1	1 unit	101
		3RA29 08-1A				
Screwdrivers for all SIRIUS devices with spring-type terminals length approx. 200 mm, 3.0 mm x 0.5 mm, titanium gray/black, partially insulated						
3RA29 08-1A						
Blank labels						
	D	Unit labeling plates¹⁾ for SIRIUS devices 20 mm x 7 mm, pastel turquoise		100	340 units	101
		3RT19 00-1SB20				
3RT19 00-1SB20						

Spare parts

For soft starters		Version	DT	Order No.	Price per PU	PU (UNIT, SET, M)	PS*	PG
Type	Size	Rated control supply voltage U_s						
Fans								
	Fans							
	3RW40 5.-.BB3.	S6	115 V AC	▶	3RW49 36-8VX30	1	1 unit	131
	3RW40 5.-.BB4.	S6	230 V AC	▶	3RW49 36-8VX40	1	1 unit	131
	3RW40 7.-.BB3.	S12	115 V AC	▶	3RW49 47-8VX30	1	1 unit	131
	3RW40 7.-.BB4.	S12	230 V AC	▶	3RW49 47-8VX40	1	1 unit	131

SIRIUS 3RW Soft Starters

3RW30, 3RW40 for Standard Applications

3RW40

More information

Application examples for normal starting (CLASS 10)

Normal starting CLASS 10 (up to 20 s with 350 % $I_{n \text{ motor}}$)

The soft starter rating can be selected to be as high as the rating of the motor used.

Application		Conveyor belt	Roller conveyor	Compressor	Small fan ¹⁾	Pump	Hydraulic pump
Starting parameters							
• Voltage ramp and current limiting							
- Starting voltage	%	70	60	50	40	40	40
- Starting time	s	10	10	10	10	10	10
- Current limit value		$5 \times I_M$	$5 \times I_M$	$4 \times I_M$	$4 \times I_M$	$4 \times I_M$	$4 \times I_M$
Ramp-down time	s	5	5	0	0	10	0

¹⁾ The mass inertia of the fan is <10 times the mass inertia of the motor.

Application examples for heavy starting (CLASS 20)

Heavy starting CLASS 20 (up to 40 s with 350 % $I_{n \text{ motor}}$)

The soft starter has to be selected at least one performance class higher than the motor used.

Application		Stirrer	Centrifuge
Starting parameters			
• Voltage ramp and current limiting			
- Starting voltage	%	40	40
- Starting time	s	20	20
- Current limit value		$4 \times I_M$	$4 \times I_M$
Ramp-down time		0	0

Note:

These tables present sample set values and device sizes. They are intended only for the purposes of information and are not binding. The set values depend on the application in question and must be optimized during commissioning.

The soft starter dimensions should be checked where necessary with the Win-Soft Starter software or with the help of Technical Assistance.

SIRIUS 3RW Soft Starters

3RW30, 3RW40 for Standard Applications

3RW40

Configuration

The 3RW solid-state soft starters are designed for easy starting conditions. In the event of deviating conditions or increased switching frequency, it may be necessary to choose a larger device. For accurate dimensioning, use the Win-Soft Starter selection and simulation program.

Where long starting times are involved, the integrated solid-state overload relay for heavy starting should not be disconnected. PTC sensors are recommended. This also applies for the smooth ramp-down because during the ramp-down time an additional current loading applies in contrast to free ramp-down.

In the case of high switching frequencies in S4 mode, Siemens recommends the use of PTC sensors. For corresponding device versions with integrated thermistor motor protection or separate thermistor evaluation devices see Chapter 8 "Monitoring and Control Devices".

No capacitive elements are permitted in the motor feeder between the SIRIUS 3RW soft starter and the motor (e. g. no reactive-power compensation equipment). In addition, neither static systems for reactive-power compensation nor dynamic PFC (Power Factor Correction) must be operated in parallel during starting and ramp-down of the soft starter. This is important to prevent faults arising on the compensation equipment and/or the soft starter.

All elements of the main circuit (such as fuses and controls) should be dimensioned for direct starting, following the local short-circuit conditions. Fuses, controls and overload relays must be ordered separately. Please observe the maximum switching frequencies specified in the technical specifications.

Note:

When induction motors are switched on, voltage drops occur as a rule on starters of all types (direct starters, wye-delta starters, soft starters). The infeed transformer must always be dimensioned such that the voltage dip when starting the motor remains within the permissible tolerance. If the infeed transformer is dimensioned with only a small margin, it is best for the control voltage to be supplied from a separate circuit (independently of the main voltage) in order to avoid the potential switching off of the soft starter.

Schematic circuit diagram of power electronics

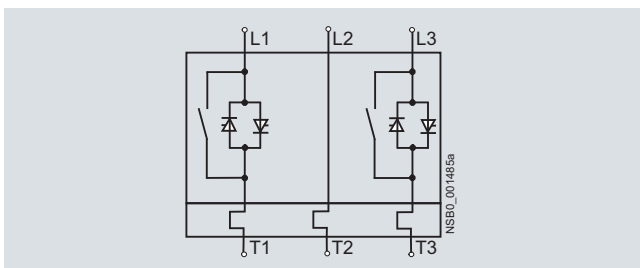

A bypass contact system and solid-state overload relay are already integrated in the 3RW40 soft starter and therefore do not have to be ordered separately.

Status graphs

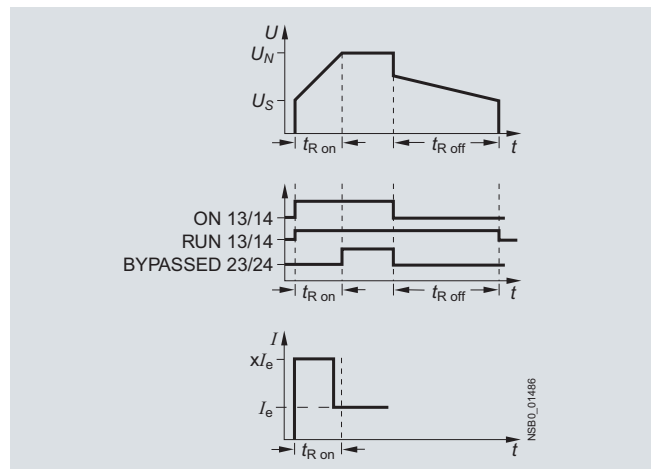

Manual for SIRIUS 3RW30/40

Besides containing all important information on configuring, commissioning and servicing, the manual also contains example circuits and the technical specifications for all devices.

Win-Soft Starter selection and simulation program

With this software, you can simulate and select all Siemens soft starters, taking into account various parameters such as mains properties, motor and load data, and special application requirements.

The software is a valuable tool, which makes complicated, lengthy manual calculations for determining the required soft starters superfluous.

The Win-Soft Starter selection and simulation program can be downloaded from:

www.siemens.com/softstarter --> Software

More information about soft starters can be found on the Internet at:

www.siemens.com/softstarter

Training course for SIRIUS soft starters (SD-SIRIUSO)

Siemens offers a 2-day training course on the SIRIUS solid-state soft starters to keep customers and own personnel up-to-date on configuring, commissioning and maintenance issues.

You can find more information on our SITRAIN website:

www.siemens.com/sitrain

--> For course name select "SD-SIRIUSO"

Please direct enquiries and applications to SITRAIN Customer Support:

Tel.: +49 (1805) 23 56 11

Fax: +49 (1805) 23 56 12

E-mail: info@sitrain.com

SIRIUS 3RW Soft Starters

3RW44 for High-Feature Applications

3RW44

Overview

In addition to soft starting and soft ramp-down, the solid-state SIRIUS 3RW44 soft starters provide numerous functions for higher-level requirements. They cover a performance range up to 710 kW (at 400 V) in the inline circuit and up to 1200 kW (at 400 V) in the inside-delta circuit.

The 3RW44 soft starters are characterized by a compact design for space-saving and clearly arranged control cabinet layouts. For optimized motor starting and stopping the innovative SIRIUS 3RW44 soft starters are an attractive alternative with considerable savings potential compared to applications with a frequency converter. The new torque control and adjustable current limiting enable the High-Feature soft starters to be used in nearly every conceivable task. They guarantee the reliable avoidance of sudden torque applications and current peaks during motor starting and stopping. This creates savings potential when calculating the size of the switchgear and when servicing the machinery installed. Be it for inline circuits or inside-delta circuits – the SIRIUS 3RW44 soft starter offers savings especially in terms of size and equipment costs.

The bypass contacts already integrated in the soft starter bypass the thyristors after a motor ramp-up is detected. This results in a further great reduction in the heat loss occurring during operation of the soft starter at rated value.

Combinations of various starting, operating and ramp-down possibilities ensure an optimum adaptation to the application-specific requirements. Operation and commissioning can be performed with the menu-controlled keypad and a menu-prompted, multi-line graphic display with background lighting. The optimized motor ramp-up and ramp-down can be effected quickly, easily and reliably by means of just a few settings with a previously selected language. Four-key operation and plain-text displays for each menu point guarantee full clarity at every moment of the parameterization and operation.

Applicable standards

- IEC 60947-4-2
- UL/CSA

Functionality

Equipped with modern, ergonomic user prompting the 3RW44 soft starters can be commissioned quickly and easily using a keypad and a menu-prompted, multi-line graphic display with background lighting. The optimized motor ramp-up and ramp-down can be effected quickly, easily and reliably by means of just a few settings with a selectable language. Four-key operation and plain-text displays for each menu point guarantee full clarity at every moment of the parameterization and operation. During operation and when control voltage is applied, the display field continuously presents measured values and operating values as well as warnings and fault messages. An external display and operator module can be connected by means of a connection cable to the soft starter, thus enabling active indications and the like to be read directly from the control cabinet door.

The SIRIUS 3RW44 soft starters are equipped with optimum functionality. An integral bypass contact system reduces the power loss of the soft starter during operation. This reliably prevents heating of the switchgear environment. The SIRIUS 3RW44 soft starters have internal intrinsic device protection. This prevents thermal overloading of the power section's thyristors, e. g. due to unacceptably high closing operations.

Wiring outlay for installing an additional motor overload relay is no longer needed as the SIRIUS 3RW44 soft starters perform this function too. In addition they offer adjustable trip classes and a thermistor motor protection function. As an option the thyristors can also be protected by SITOR semiconductor fuses from short-circuiting so that the soft starter is still functional after a short circuit (coordination type "2"). And even inrush current peaks are reliably avoided thanks to adjustable current limiting.

As a further option the SIRIUS 3RW44 soft starters can be upgraded with a PROFIBUS DP module. Thanks to their communication capability and their programmable control inputs and relay outputs the SIRIUS 3RW44 soft starters can be very easily and quickly integrated in higher-level controllers.

In addition a creep speed function is available for positioning and setting jobs. With this function the motor can be controlled in both directions of rotation with reduced torque and an adjustable, low speed.

On the other hand the SIRIUS 3RW44 soft starters offer a new, combined DC braking function for the fast stopping of driving loads.

Highlights

- Soft starting with breakaway pulse, torque control or voltage ramp, adjustable torque or current limiting as well as any combination of these, depending on load type
- Integrated bypass contact system to minimize power loss
- Various setting options for the starting parameters such as starting torque, starting voltage, ramp-up and ramp-down time, and much more in three separate parameter sets
- Start-up detection
- Inside-delta circuit for savings in terms of size and equipment costs
- Various ramp-down modes selectable: free ramp-down, torque-controlled pump ramp-down, combined DC braking
- Solid-state motor overload and intrinsic device protection
- Thermistor motor protection
- Keypad with a menu-prompted, multi-line graphic display with background lighting
- Interface for communication with the PC for more accurate setting of the parameters as well as for control and monitoring
- Simple adaptation to the motor feeder
- Simple mounting and commissioning
- Display of operating states and fault messages
- Connection to PROFIBUS with optional PROFIBUS DP module
- External display and operator module
- Mains voltages from 200 to 690 V, 50 to 60 Hz
- Can be used up to 60 °C (derating from 40 °C)

Soft Starter ES parameterization software¹⁾

Soft Starter ES software is used for the parameterization, monitoring and service diagnostics of SIRIUS 3RW44 High Feature soft starters.

SIRIUS 3RW44 Soft Starter Function Block Library for SIMATIC PCS 7¹⁾

The SIRIUS 3RW44 soft starter PCS 7 function block library can be used for simple and easy integration of SIRIUS 3RW44 soft starters into the SIMATIC PCS 7 process control system.

¹⁾ See Chapter 12 "Planning, Configuration and Visualizing for SIRIUS".

Application

The SIRIUS 3RW44 solid-state soft starters are suitable for the torque-controlled soft starting and smooth ramp-down as well as braking of three-phase asynchronous motors.

Application areas

See "Selection aid for soft starters" on page 4/6.

SIRIUS 3RW Soft Starters

3RW44 for High-Feature Applications

3RW44

Technical specifications

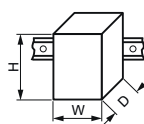
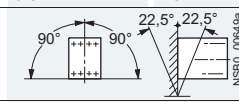
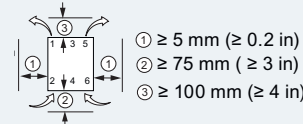
Type		3RW44 2.	3RW44 3.	3RW44 4.	3RW44 5.	3RW44 6.	
Mechanics and environment							
Mounting dimensions (WxHxD)							
<ul style="list-style-type: none"> Screw terminals Spring-type terminals 		mm	170 x 184 x 270	170 x 198 x 270	210 x 230 x 298	510 x 638.5 x 290	576 x 667 x 290
		mm	170 x 184 x 270	170 x 198 x 270	210 x 230 x 298	510 x 638.5 x 290	576 x 667 x 290
Permissible ambient temperature							
Operation	°C	0 ... +60; (derating from +40)					
Storage	°C	-25 ... +80					
Weight							
	kg	6.5	7.9	11.5	50	78	
Permissible mounting position							
							
Installation type							
Stand-alone installation							
							
Permissible installation altitude							
	m	5 000 (derating from 1000, see Characteristic curves page 4/7); higher on request					
Degree of protection							
IP00							

Type	Terminal		3RW44 ...BC3.	3RW44 ...BC4.
Control electronics				
Rated values				
Rated control supply voltage	A1/A2/PE	V	115 AC	230 AC
• Tolerance		%	-15/+10	-15/+10
Rated frequency		Hz	50 ... 60	50 ... 60
• Tolerance		%	±10	±10

Type		3RW44 ...BC.4	3RW44 ...BC.5	3RW44 ...BC.6
Power electronics				
Rated operational voltage for inline circuit	V AC	200 ... 460	400 ... 600	400 ... 690
Tolerance	%	-15/+10	-15/+10	-15/+10
Maximum blocking voltage (thyristor)	V AC	1 400	1 800	1 800
Rated operational voltage for inside-delta circuit	V AC	200 ... 460	400 ... 600	400 ... 600
Tolerance	%	-15/+10	-15/+10	-15/+10
Rated frequency	Hz	50 ... 60		
Tolerance	%	±10		
Uninterrupted duty at 40 °C (% of I_e)	%	115		
Minimum load (% of set motor current I_M)	%	8		
Maximum cable length between soft starter and motor	m	500 ¹⁾		

¹⁾ At the project configuration stage, it is important to make allowance for the voltage drop on the motor cable up to the motor connection. If necessary, higher values for the rated operational voltage or current must be calculated accordingly for the soft starter.

SIRIUS 3RW Soft Starters

3RW44 for High-Feature Applications

3RW44

Motor feeders with soft starters

The type of coordination to which the motor feeder with soft starter is mounted depends on the application-specific requirements. Normally, fuseless mounting (combination of motor starter protector/circuit breaker and soft starter) is sufficient.

If type of coordination "2" is to be fulfilled, semiconductor fuses must be fitted in the motor feeder.

ToC 1

Type of coordination "1" according to IEC 60947-4-1: After a short-circuit incident the unit is defective therefore unsuitable for further use (protection of persons and equipment guaranteed).

ToC 2

Type of coordination "2" according to IEC 60947-4-1: After a short-circuit incident the unit is suitable for further use (protection of persons and equipment guaranteed).

The type of coordination refers to soft starters in combination with the stipulated protective device (motor starter protector/circuit breaker/fuse), not to any additional components in the feeder.

The types of coordination are indicated in the corresponding tables by the symbols shown on orange backgrounds.

Inline circuit fuseless version

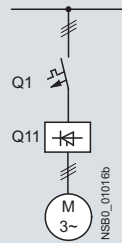

Soft starters		Motor starter protectors/circuit breakers ¹⁾	
Type	Rated current A	Type	Rated current A
Type of coordination "1": 3RW44 22 ... 3RW44 27: $I_q = 32 \text{ kA}$; 3RW44 34 and 3RW44 35: $I_q = 16 \text{ kA}$; 3RW44 36 ... 3RW44 66: $I_q = 65 \text{ kA}$			
3RW44 22	29	3RV10 42-4HA10	50
3RW44 23	36	3RV10 42-4JA10	63
3RW44 24	47	3RV10 42-4KA10	75
3RW44 25	57	3RV10 42-4LA10	90
3RW44 26	77	3RV10 42-4MA10	100
3RW44 27	93	3RV10 42-4MA10	100
3RW44 34	113	3VL17 16-2DD36	160
3RW44 35	134	3VL17 16-2DD36	160
3RW44 36	162	3VL37 25-2DC36	250
3RW44 43	203	3VL47 31-3DC36	315
3RW44 44	250	3VL47 31-3DC36	315
3RW44 45	313	3VL47 40-3DC36	400
3RW44 46	356	3VL47 40-3DC36	400
3RW44 47	432	3VL57 50-3DC36	500
3RW44 53	551	3VL67 80-3AB36	800
3RW44 54	615	3VL67 80-3AB36	800
3RW44 55	693	3VL67 80-3AB36	800
3RW44 56	780	3VL77 10-3AB36	1 000
3RW44 57	880	3VL77 10-3AB36	1 000
3RW44 58	970	3VL77 12-3AB36	1 250
3RW44 65	1 076	3VL77 12-3AB36	1 250
3RW44 66	1 214	3VL77 12-3AB36	1 250

¹⁾ The rated motor current must be considered when selecting the devices.

SIRIUS 3RW Soft Starters

3RW44 for High-Feature Applications

3RW44

Inline circuit fused version (line protection only)

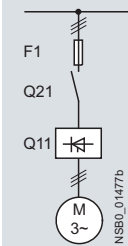

Soft starters Q11 Type	Rated current A	Line fuses, maximum 690 V +5 %			Line contactor up to 400 V (optional) Q21 Type	Braking contactors ¹⁾²⁾ (for example circuit see the 3RW44 manual)	
		F1 Type	Rated current A	Size		Q91 Type	Q92 Type
Type of coordination "1"³⁾: $I_q = 65 \text{ kA}$							
3RW44 22	29	3NA3 820-6	50	00	3RT10 34	3RT15 26	--
3RW44 23	36	3NA3 822-6	63	00	3RT10 35	3RT15 26	--
3RW44 24	47	3NA3 824-6	80	00	3RT10 36	3RT15 35	--
3RW44 25	57	3NA3 830-6	100	00	3RT10 44	3RT15 35	--
3RW44 26	77	3NA3 132-6	125	1	3RT10 45	3RT10 24	3RT10 35
3RW44 27	93	3NA3 136-6	160	1	3RT10 46	3RT10 25	3RT10 36
3RW44 34	113	3NA3 244-6	250	2	3RT10 54	3RT10 34	3RT10 44
3RW44 35	134	3NA3 244-6	250	2	3RT10 55	3RT10 36	3RT10 45
3RW44 36	162	3NA3 365-6	500	3	3RT10 56	3RT10 44	3RT10 45
3RW44 43	203	2 x 3NA3 354-6	2 x 355	3	3RT10 64	3RT10 44	3RT10 54
3RW44 44	250	2 x 3NA3 354-6	2 x 355	3	3RT10 65	3RT10 44	3RT10 55
3RW44 45	313	2 x 3NA3 365-6	2 x 500	3	3RT10 75	3RT10 54	3RT10 56
3RW44 46	356	2 x 3NA3 365-6	2 x 500	3	3RT10 75	3RT10 54	3RT10 56
3RW44 47	432	2 x 3NA3 365-6	2 x 500	3	3RT10 76	3RT10 55	3RT10 64
3RW44 53	551	2 x 3NA3 365-6	2 x 500	3	3TF68	3RT10 64	3RT10 66
3RW44 54	615	2 x 3NA3 365-6	2 x 500	3	3TF68	3RT10 64	3RT10 75
3RW44 55	693	2 x 3NA3 365-6	2 x 500	3	3TF69	3RT10 65	3RT10 75
3RW44 56	780	2 x 3NA3 365-6	2 x 500	3	3TF69	3RT10 65	3RT10 75
3RW44 57	880	2 x 3NA3 365-6	2 x 500	3	--	3RT10 75	3RT10 76
3RW44 58	970	3 x 3NA3 365-6	3 x 500	3	--	3RT10 75	3RT10 76
3RW44 65	1076	3 x 3NA3 365-6	3 x 500	3	--	3RT10 75	3TF68
3RW44 66	1214	3 x 3NA3 365-6	3 x 500	3	--	3RT10 76	3TF68

1) If the ramp-down function "Combined braking" is selected, no braking contactor is required.
If the ramp-down function "DC braking" is selected, a braking contactor must be used in addition (see table for type).
For applications with large centrifugal masses ($J_{Load} > J_{Motor}$) we recommend the function "DC braking".

2) Additional auxiliary relay K4:
LZX:RT4A4T30
(3RW44 soft starter with rated control supply voltage 230 V AC),
LZX:RT4A4S15
(3RW44 soft starter with rated control supply voltage 115 V AC).

3) The type of coordination "1" refers to soft starters in combination with the stipulated fuse, not to any additional components in the feeder.



SIRIUS 3RW Soft Starters

3RW44 for High-Feature Applications

3RW44

Inline circuit fused version with 3NE1 SITOR all-range fuse (semiconductor and line protection)

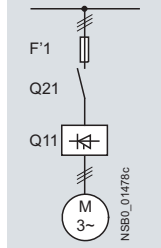

For matching fuse bases see Catalog LV 10.1

- "Switch Disconnectors"
- "Fuse Systems" --> "SITOR Semiconductor Fuses" or at www.siemens.com/sitor

Soft starters Q11 Type	ToC 2 Rated current A	All-range fuses				Line contactor up to 400 V (optional) Q21 Type	Braking contactors ¹⁾²⁾ (for example circuit see the 3RW44 manual) Q91 Type		Q92 Type
		F1 Type	Rated current A	Voltage V	Size				
Type of coordination "2"³⁾: $I_q = 65 \text{ kA}$									
3RW44 22	29	3NE1 020-2	80	690 +5 %	00	3RT10 34	3RT15 26	--	
3RW44 23	36	3NE1 020-2	80	690 +5 %	00	3RT10 35	3RT15 26	--	
3RW44 24	47	3NE1 021-2	100	690 +5 %	00	3RT10 36	3RT15 35	--	
3RW44 25	57	3NE1 022-2	125	690 +5 %	00	3RT10 44	3RT15 35	--	
3RW44 26	77	3NE1 022-2	125	690 +5 %	00	3RT10 45	3RT10 24	3RT10 35	
3RW44 27	93	3NE1 224-2	160	690 +5 %	1	3RT10 46	3RT10 25	3RT10 36	
3RW44 34	113	3NE1 225-2	200	690 +5 %	1	3RT10 54	3RT10 34	3RT10 44	
3RW44 35	134	3NE1 227-2	250	690 +5 %	1	3RT10 55	3RT10 36	3RT10 45	
3RW44 36	162	3NE1 227-2	250	690 +5 %	1	3RT10 56	3RT10 44	3RT10 45	
3RW44 43	203	3NE1 230-2	315	600 +10 %	1	3RT10 64	3RT10 44	3RT10 54	
3RW44 44	250	3NE1 331-2	350	460 +10 %	2	3RT10 65	3RT10 44	3RT10 55	
3RW44 45	313	3NE1 333-2	450	690 +5 %	2	3RT10 75	3RT10 54	3RT10 56	
3RW44 46	356	3NE1 334-2	500	690 +5 %	2	3RT10 75	3RT10 54	3RT10 56	
3RW44 47	432	3NE1 435-2	560	690 +5 %	3	3RT10 76	3RT10 55	3RT10 64	
3RW44 53	551	2 x 3NE1 334-2	500	690 +10 %	2	3TF68	3RT10 64	3RT10 66	
3RW44 54	615	2 x 3NE1 334-2	500	690 +10 %	2	3TF68	3RT10 64	3RT10 75	
3RW44 55	693	2 x 3NE1 334-2	500	690 +10 %	2	3TF69	3RT10 65	3RT10 75	
3RW44 56	780	2 x 3NE1 435-2	560	690 +10 %	3	3TF69	3RT10 65	3RT10 75	
3RW44 57	880	2 x 3NE1 435-2	560	690 +10 %	3	--	3RT10 75	3RT10 76	
3RW44 58	970	2 x 3NE1 435-2	560	690 +10 %	3	--	3RT10 75	3RT10 76	
3RW44 65	1076	3 x 3NE1 334-2	500	690 +10 %	2	--	3RT10 75	3TF68	
3RW44 66	1214	3 x 3NE1 435-2	560	690 +10 %	3	--	3RT10 76	3TF68	

¹⁾ If the ramp-down function "Combined braking" is selected, no braking contactor is required.
If the ramp-down function "DC braking" is selected, a braking contactor must be used in addition (see table for type).
For applications with large centrifugal masses ($J_{Load} > J_{Motor}$) we recommend the function "DC braking".

²⁾ Additional auxiliary relay K4:
LZX:RT4A4T30
(3RW44 soft starter with rated control supply voltage 230 V AC),
LZX:RT4A4S15
(3RW44 soft starter with rated control supply voltage 115 V AC).

³⁾ The type of coordination "2" refers to soft starters in combination with the stipulated fuse, not to any additional components in the feeder.

SIRIUS 3RW Soft Starters

3RW44 for High-Feature Applications

3RW44

Inline circuit fused version with 3NE or 3NC SITOR semiconductor fuse
(semiconductor protection by fuse, line and overload protection by motor starter protector/circuit breaker)

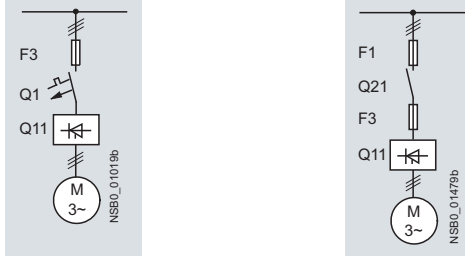

For matching fuse bases see Catalog LV 10.1

- "Switch Disconnectors"
- "Fuse Systems" --> "SITOR Semiconductor Fuses" or at www.siemens.com/sitor

Soft starters Q11 Type	T _{OC} 2 Rated current A	Semiconductor fuses, minimum			Semiconductor fuses, maximum			Semiconductor fuses (cylinder)		
		690 V +10 % F3 Type	Rated current A	Size	690 V +10 % F3 Type	Rated current A	Size	F3 Type	Rated current A	Size
Type of coordination "2"⁽³⁾: I_q = 65 kA										
3RW44 22	29	3NE4 120	80	0	3NE4 121	100	0	3NC2 280	80	22 x 58
3RW44 23	36	3NE4 121	100	0	3NE4 121	100	0	3NC2 200	100	22 x 58
3RW44 24	47	3NE4 121	100	0	3NE4 122	125	0	3NC2 200	100	22 x 58
3RW44 25	57	3NE4 122	125	0	3NE4 124	160	0	--	--	--
3RW44 26	77	3NE4 124	160	0	3NE4 124	160	0	--	--	--
3RW44 27	93	3NE3 224	160	1	3NE3 332-0B	400	2	--	--	--
3RW44 34	113	3NE3 225	200	1	3NE3 335	560	2	--	--	--
3RW44 35	134	3NE3 225	200	1	3NE3 335	560	2	--	--	--
3RW44 36	162	3NE3 227	250	1	3NE3 333	450	2	--	--	--
3RW44 43	203	3NE3 230-0B	315	1	3NE3 333	450	2	--	--	--
3RW44 44	250	3NE3 230-0B	315	1	3NE3 333	450	2	--	--	--
3RW44 45	313	3NE3 233	450	1	3NE3 336	630	2	--	--	--
3RW44 46	356	3NE3 333	450	2	3NE3 336	630	2	--	--	--
3RW44 47	432	3NE3 335	560	2	3NE3 338-8	800	2	--	--	--
3RW44 53	551	2 x 3NE3 335	560	2	3 x 3NE3 334-0B	500	2	--	--	--
3RW44 54	615	2 x 3NE3 335	560	2	3 x 3NE3 334-0B	500	2	--	--	--
3RW44 55	693	2 x 3NE3 335	560	2	3 x 3NE3 334-0B	500	2	--	--	--
3RW44 56	780	2 x 3NE3 336	630	2	2 x 3NE3 340-8	900	2	--	--	--
3RW44 57	880	2 x 3NE3 336	630	2	2 x 3NE3 340-8	900	2	--	--	--
3RW44 58	970	2 x 3NE3 336	630	2	2 x 3NE3 340-8	900	2	--	--	--
3RW44 65	1076	2 x 3NE3 340-8	900	2	3 x 3NE3 338-8	800	2	--	--	--
3RW44 66	1214	2 x 3NE3 340-8	900	2	3 x 3NE3 338-8	800	2	--	--	--

Soft starters Q11 Type	T _{OC} 2 Rated current A	Line contactor up to 400 V (optional) Q21 Type	Braking contactors ¹⁾²⁾ (for example circuit see the 3RW44 manual) Q91 Type		Motor starter protectors/ circuit breakers 440 V +10 % Q1 Type		Line fuses, maximum 690 V +5 % F1 Type		
			Q92 Type	Rated current A	Rated current A	Size			
Type of coordination "2"⁽³⁾: I_q = 65 kA									
3RW44 22	29	3RT10 34	3RT15 26	--	3RV10 41-4HA10	50	3NA3 820-6	50	00
3RW44 23	36	3RT10 35	3RT15 26	--	3RV10 41-4JA10	63	3NA3 822-6	63	00
3RW44 24	47	3RT10 36	3RT15 35	--	3RV10 41-4KA10	75	3NA3 824-6	80	00
3RW44 25	57	3RT10 44	3RT15 35	--	3RV10 41-4LA10	90	3NA3 830-6	100	00
3RW44 26	77	3RT10 45	3RT10 24	3RT10 35	3RV10 41-4MA10	100	3NA3 132-6	125	1
3RW44 27	93	3RT10 46	3RT10 25	3RT10 36	3RV10 41-4MA10	100	3NA3 136-6	160	1
3RW44 34	113	3RT10 54	3RT10 34	3RT10 44	3VL17 16	160	3NA3 244-6	250	2
3RW44 35	134	3RT10 55	3RT10 36	3RT10 45	3VL17 16	160	3NA3 244-6	250	2
3RW44 36	162	3RT10 56	3RT10 44	3RT10 45	3VL37 25	250	3NA3 365-6	500	3
3RW44 43	203	3RT10 64	3RT10 44	3RT10 54	3VL47 31	315	2 x 3NA3 354-6	2 x 355	3
3RW44 44	250	3RT10 65	3RT10 44	3RT10 55	3VL47 31	315	2 x 3NA3 354-6	2 x 355	3
3RW44 45	313	3RT10 75	3RT10 54	3RT10 56	3VL47 40	400	2 x 3NA3 365-6	2 x 500	3
3RW44 46	356	3RT10 75	3RT10 54	3RT10 56	3VL47 40	400	2 x 3NA3 365-6	2 x 500	3
3RW44 47	432	3RT10 76	3RT10 55	3RT10 64	3VL57 50	500	2 x 3NA3 365-6	2 x 500	3
3RW44 53	551	3TF68	3RT10 64	3RT10 66	3VL67 80	800	2 x 3NA3 365-6	2 x 500	3
3RW44 54	615	3TF68	3RT10 64	3RT10 75	3VL67 80	800	2 x 3NA3 365-6	2 x 500	3
3RW44 55	693	3TF69	3RT10 65	3RT10 75	3VL67 80	800	2 x 3NA3 365-6	2 x 500	3
3RW44 56	780	3TF69	3RT10 65	3RT10 75	3VL77 10	1000	2 x 3NA3 365-6	2 x 500	3
3RW44 57	880	--	3RT10 75	3RT10 76	3VL77 10	1000	2 x 3NA3 365-6	2 x 500	3
3RW44 58	970	--	3RT10 75	3RT10 76	3VL77 12	1250	3 x 3NA3 365-6	3 x 500	3
3RW44 65	1076	--	3RT10 75	3TF68	3VL77 12	1250	3 x 3NA3 365-6	3 x 500	3
3RW44 66	1214	--	3RT10 76	3TF68	3VL77 12	1250	3 x 3NA3 365-6	3 x 500	3

¹⁾ If the ramp-down function "Combined braking" is selected, no braking contactor is required. If the ramp-down function "DC braking" is selected, a braking contactor must be used in addition (see table for type).
For applications with large centrifugal masses ($J_{Load} > J_{Motor}$) we recommend the function "DC braking".

²⁾ Additional auxiliary relay K4:
LZX:RT4A4T30 (3RW44 soft starter with rated control supply voltage 230 V AC),
LZX:RT4A4S15 (3RW44 soft starter with rated control supply voltage 115 V AC).

³⁾ The type of coordination "2" refers to soft starters in combination with the stipulated protective device (motor starter protector/circuit breaker/fuse), not to any additional components in the feeder.

SIRIUS 3RW Soft Starters

3RW44 for High-Feature Applications

3RW44

Inside-delta circuit fused version with 3NE or 3NC SITOR fuses
 (semiconductor protection by fuse, lead and overload protection by motor starter protector/circuit breaker)

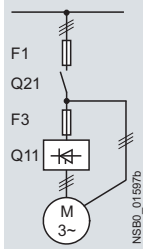
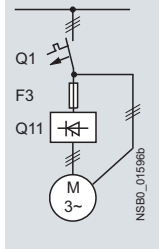

For matching fuse bases see Catalog LV 10.1

- "Switch Disconnectors"
- "Fuse Systems" --> "SITOR Semiconductor Fuses" or at www.siemens.com/sitor

Soft starters Q11 Type	Rated current A	Semiconductor fuses, minimum			Semiconductor fuses, maximum			Semiconductor fuses (cylinder)		
		690 V +10 % F3 Type	Rated current A	Size	690 V +10 % F3 Type	Rated current A	Size	F3 Type	Rated current A	Size
Type of coordination "2"¹⁾										
3RW44 22	50	3NE4 120	80	0	3NE4 121	100	0	3NC2 280	80	22 x 58
3RW44 23	62	3NE4 121	100	0	3NE4 121	100	0	3NC2 200	100	22 x 58
3RW44 24	81	3NE4 121	100	0	3NE4 122	125	0	3NC2 200	100	22 x 58
3RW44 25	99	3NE4 122	125	0	3NE4 124	160	0	--	--	--
3RW44 26	133	3NE4 124	160	0	3NE4 124	160	0	--	--	--
3RW44 27	161	3NE3 224	160	1	3NE3 332-0B	400	2	--	--	--
3RW44 34	196	3NE3 225	200	1	3NE3 335	560	2	--	--	--
3RW44 35	232	3NE3 225	200	1	3NE3 335	560	2	--	--	--
3RW44 36	281	3NE3 227	250	1	3NE3 333	450	2	--	--	--
3RW44 43	352	3NE3 230-0B	315	1	3NE3 333	450	2	--	--	--
3RW44 44	433	3NE3 230-0B	315	1	3NE3 333	450	2	--	--	--
3RW44 45	542	3NE3 233	450	1	3NE3 336	630	2	--	--	--
3RW44 46	617	3NE3 333	450	2	3NE3 336	630	2	--	--	--
3RW44 47	748	3NE3 335	560	2	3NE3 338-8	800	2	--	--	--
3RW44 53	954	2 x 3NE3 335	560	2	3 x 3NE3 334-0B	500	2	--	--	--
3RW44 54	1065	2 x 3NE3 335	560	2	3 x 3NE3 334-0B	500	2	--	--	--
3RW44 55	1200	2 x 3NE3 335	560	2	3 x 3NE3 334-0B	500	2	--	--	--
3RW44 56	1351	2 x 3NE3 336	630	2	2 x 3NE3 340-8	900	2	--	--	--
3RW44 57	1524	2 x 3NE3 336	630	2	3 x 3NE3 340-8	900	2	--	--	--
3RW44 58	1680	2 x 3NE3 336	630	2	3 x 3NE3 340-8	900	2	--	--	--
3RW44 65	1864	2 x 3NE3 340-8	900	2	3 x 3NE3 338-8	800	2	--	--	--
3RW44 66	2103	2 x 3NE3 340-8	900	2	3 x 3NE3 338-8	800	2	--	--	--

Soft starters Q11 Type	Rated current A	Line contactor up to 400 V (optional) Q21 Type	Motor starter protectors/ circuit breakers		Line fuses, maximum		
			440 V +10 % Q1 Type	Rated current A	690 V +5 % F1 Type	Rated current A	Size
Type of coordination "2"¹⁾							
3RW44 22	50	3RT10 36-1AP04	3RV10 42-4KA10	75	3NA3 824-6	80	00
3RW44 23	62	3RT10 44-1AP04	3RV10 42-4LA10	90	3NA3 830-6	100	00
3RW44 24	81	3RT10 46-1AP04	3RV10 42-4MA10	100	3NA3 132-6	125	1
3RW44 25	99	3RT10 54-1AP36	3VL27 16	160	3NA3 136-6	160	1
3RW44 26	133	3RT10 55-6AP36	3VL27 16	160	3NA3 240-6	200	2
3RW44 27	161	3RT10 56-6AP36	3VL37 20	200	3NA3 244-6	250	2
3RW44 34	196	3RT10 64-6AP36	3VL37 25	250	3NA3 360-6	400	3
3RW44 35	232	3RT10 65-6AP36	3VL47 31	315	3NA3 360-6	400	3
3RW44 36	281	3RT10 66-6AP36	3VL47 40	400	2 x 3NA3 360-6	2 x 400	3
3RW44 43	352	3RT10 75-6AP36	3VL47 40	400	2 x 3NA3 365-6	2 x 500	3
3RW44 44	433	3RT10 76-6AP36	3VL57 50	500	2 x 3NA3 365-6	2 x 500	3
3RW44 45	542	3TF68 44-OCM7	3VL57 63	800	3 x 3NA3 365-6	3 x 500	3
3RW44 46	617	3TF68 44-OCM7	3VL67 80	800	3 x 3NA3 365-6	3 x 500	3
3RW44 47	748	3TF69	3VL67 80	800	3 x 3NA3 365-6	3 x 500	3
3RW44 53	954	--	3VL77 10	1000	3 x 3NA3 365-6	3 x 500	3
3RW44 54	1065	--	3VL77 12	1250	3 x 3NA3 365-6	3 x 500	3
3RW44 55	1200	--	3VL87 16	1600	3 x 3NA3 365-6	3 x 500	3
3RW44 56	1351	--	3VL87 16	1600	3 x 3NA3 372	3 x 630	3
3RW44 57	1524	--	3VL87 16	1600	3 x 3NA3 372	3 x 630	3
3RW44 58	1680	--	3WL12 20	2000	2 x 3NA3 480	2 x 1000	4
3RW44 65	1864	--	3WL12 25	2500	2 x 3NA3 482	2 x 1250	4
3RW44 66	2103	--	3WL12 25	2500	2 x 3NA3 482	2 x 1250	4

¹⁾ The type of coordination "2" refers to soft starters in combination with the stipulated protective device (motor starter protector/circuit breaker/fuse), not to any additional components in the feeder.

SIRIUS 3RW Soft Starters

3RW44 for High-Feature Applications

3RW44

Selection and ordering data

SIRIUS 3RW44 for normal starting (CLASS 10) in inline circuit

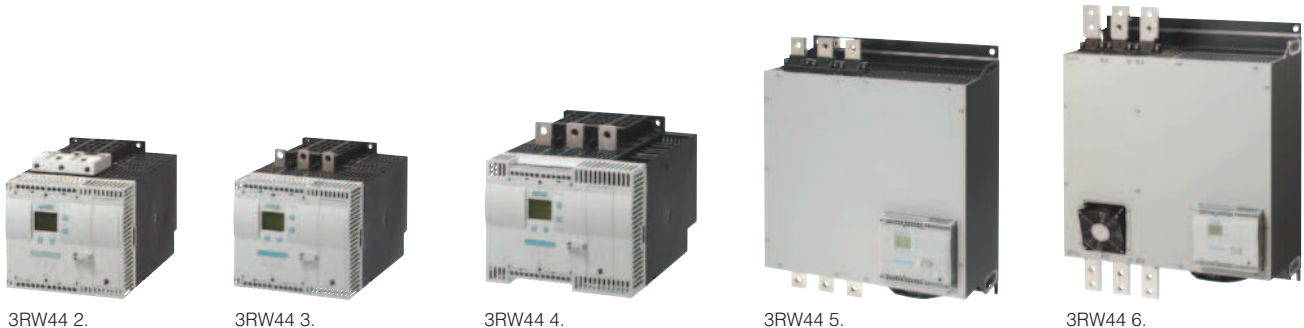

3RW44 2.					3RW44 3.				3RW44 4.				3RW44 5.		3RW44 6.		DT	Normal starting (CLASS 10) in inline circuit	PU (UNIT, SET, M)	PS*	PG
3RW ambient temperature 40 °C					3RW ambient temperature 50 °C				Order No.		Price per PU										
Rated values of induction motors					Rated values of induction motors																
Operational current I_e	Rating at operational voltage U_e				Operational current I_e	Rating at operational voltage U_e															
	230 V	400 V	500 V	690 V		1000 V	200 V	230 V	460 V	575 V	A	hp	hp	hp	hp						
kW	kW	kW	kW	kW	A	hp	hp	hp	hp												
Inline circuit, rated operational voltage 200 ... 460 V¹⁾																					
29	5.5	15	--	--	26	7.5	7.5	15	--	▶	3RW44 22-□BC□4	1	1 unit	131							
36	7.5	18.5	--	--	32	10	10	20	--	▶	3RW44 23-□BC□4	1	1 unit	131							
47	11	22	--	--	42	10	15	25	--	▶	3RW44 24-□BC□4	1	1 unit	131							
57	15	30	--	--	51	15	15	30	--	▶	3RW44 25-□BC□4	1	1 unit	131							
77	18.5	37	--	--	68	20	20	50	--	▶	3RW44 26-□BC□4	1	1 unit	131							
93	22	45	--	--	82	25	25	60	--	▶	3RW44 27-□BC□4	1	1 unit	131							
Order No. supplement for connection types																					
<ul style="list-style-type: none"> • With screw terminals • With spring-type terminals 																					
113	30	55	--	--	100	30	30	75	--	B	3RW44 34-□BC□4	1	1 unit	131							
134	37	75	--	--	117	30	40	75	--	B	3RW44 35-□BC□4	1	1 unit	131							
162	45	90	--	--	145	40	50	100	--	B	3RW44 36-□BC□4	1	1 unit	131							
203	55	110	--	--	180	50	60	125	--	B	3RW44 43-□BC□4	1	1 unit	131							
250	75	132	--	--	215	60	75	150	--	B	3RW44 44-□BC□4	1	1 unit	131							
313	90	160	--	--	280	75	100	200	--	B	3RW44 45-□BC□4	1	1 unit	131							
356	110	200	--	--	315	100	125	250	--	B	3RW44 46-□BC□4	1	1 unit	131							
432	132	250	--	--	385	125	150	300	--	B	3RW44 47-□BC□4	1	1 unit	131							
551	160	315	--	--	494	150	200	400	--	C	3RW44 53-□BC□4	1	1 unit	131							
615	200	355	--	--	551	150	200	450	--	C	3RW44 54-□BC□4	1	1 unit	131							
693	200	400	--	--	615	200	250	500	--	C	3RW44 55-□BC□4	1	1 unit	131							
780	250	450	--	--	693	200	250	600	--	C	3RW44 56-□BC□4	1	1 unit	131							
880	250	500	--	--	780	250	300	700	--	C	3RW44 57-□BC□4	1	1 unit	131							
970	315	560	--	--	850	300	350	750	--	C	3RW44 58-□BC□4	1	1 unit	131							
1076	355	630	--	--	970	350	400	850	--	C	3RW44 65-□BC□4	1	1 unit	131							
1214	400	710	--	--	1076	350	450	950	--	C	3RW44 66-□BC□4	1	1 unit	131							

Order No. supplement for connection types

- With spring-type terminals
- With screw terminals

Order No. supplement for the rated control supply voltage U_s ²⁾

- 115 V AC
- 230 V AC

¹⁾ 3RW44 2. ... 3RW44 4., soft starters with screw terminals: delivery time class ▶ (preferred type).

²⁾ Control by way of the internal 24 V DC supply and direct control by means of PLC possible.

Note:

The listed motor ratings are rough guide values. The soft starter should always be designed on the basis of the required rated operational current of the motor.

The SIRIUS 3RW44 solid-state soft starters are designed for easy starting conditions. The selection and ordering data were determined for the following boundary conditions (see also the notes on page 4/6):

- Maximum starting time in s: 10
- Maximum starting current in % of motor current I_e : 300
- Maximum number of starts per hour in 1/h: 5

In the event of more exacting requirements, it may be necessary to choose a larger device. However, in some cases the designed-in safety reserves also permit the listed units to be used in boundary conditions which are slightly more demanding. Detailed technical information for a configuration which is tailored exactly to the application can be found in the manuals. Siemens recommends the use of the selection and simulation program Win-Soft Starter.

* You can order this quantity or a multiple thereof. Illustrations are approximate

SIRIUS 3RW Soft Starters

3RW44 for High-Feature Applications

3RW44

3RW ambient temperature 40 °C						3RW ambient temperature 50 °C				DT	Normal starting (CLASS 10) in inline circuit	PU (UNIT, SET, M)	PS*	PG	
Rated values of induction motors						Rated values of induction motors									
Operational current I_e	Rating at operational voltage U_e					Operational current I_e	Rating at operational voltage U_e				Order No.	Price per PU			
	230 V	400 V	500 V	690 V	1000 V		200 V	230 V	460 V	575 V					
A	kW	kW	kW	kW	kW	A	hp	hp	hp	hp					
Inline circuit, rated operational voltage 400 ... 600 V¹⁾															
29	--	15	18.5	--	--	26	--	--	15	20	A	3RW44 22-□BC□5	1	1 unit	131
36	--	18.5	22	--	--	32	--	--	20	25	A	3RW44 23-□BC□5	1	1 unit	131
47	--	22	30	--	--	42	--	--	25	30	A	3RW44 24-□BC□5	1	1 unit	131
57	--	30	37	--	--	51	--	--	30	40	A	3RW44 25-□BC□5	1	1 unit	131
77	--	37	45	--	--	68	--	--	50	50	A	3RW44 26-□BC□5	1	1 unit	131
93	--	45	55	--	--	82	--	--	60	75	A	3RW44 27-□BC□5	1	1 unit	131
Order No. supplement for connection types • With screw terminals • With spring-type terminals															
113	--	55	75	--	--	100	--	--	75	75	B	3RW44 34-□BC□5	1	1 unit	131
134	--	75	90	--	--	117	--	--	75	100	B	3RW44 35-□BC□5	1	1 unit	131
162	--	90	110	--	--	145	--	--	100	125	B	3RW44 36-□BC□5	1	1 unit	131
203	--	110	132	--	--	180	--	--	125	150	B	3RW44 43-□BC□5	1	1 unit	131
250	--	132	160	--	--	215	--	--	150	200	B	3RW44 44-□BC□5	1	1 unit	131
313	--	160	200	--	--	280	--	--	200	250	B	3RW44 45-□BC□5	1	1 unit	131
356	--	200	250	--	--	315	--	--	250	300	B	3RW44 46-□BC□5	1	1 unit	131
432	--	250	315	--	--	385	--	--	300	400	B	3RW44 47-□BC□5	1	1 unit	131
551	--	315	355	--	--	494	--	--	400	500	C	3RW44 53-□BC□5	1	1 unit	131
615	--	355	400	--	--	551	--	--	450	600	C	3RW44 54-□BC□5	1	1 unit	131
693	--	400	500	--	--	615	--	--	500	700	C	3RW44 55-□BC□5	1	1 unit	131
780	--	450	560	--	--	693	--	--	600	750	C	3RW44 56-□BC□5	1	1 unit	131
880	--	500	630	--	--	780	--	--	700	850	C	3RW44 57-□BC□5	1	1 unit	131
970	--	560	710	--	--	850	--	--	750	900	C	3RW44 58-□BC□5	1	1 unit	131
1076	--	630	800	--	--	970	--	--	850	1100	C	3RW44 65-□BC□5	1	1 unit	131
1214	--	710	900	--	--	1076	--	--	950	1200	C	3RW44 66-□BC□5	1	1 unit	131

- Order No. supplement for connection types**
- With spring-type terminals
 - With screw terminals
- Order No. supplement for the rated control supply voltage U_s ²⁾**
- 115 V AC
 - 230 V AC

¹⁾ Soft starter with screw terminals:
 3RW44 2 ... 3RW44 4. Delivery time class A,
 3RW44 5 ... 3RW44 6. Delivery time class B.

²⁾ Control by way of the internal 24 V DC supply and direct control by means of PLC possible.

Note:

The listed motor ratings are rough guide values. The soft starter should always be designed on the basis of the required rated operational current of the motor.

The SIRIUS 3RW44 solid-state soft starters are designed for easy starting conditions. The selection and ordering data were determined for the following boundary conditions (see also the notes on page 4/6):

- Maximum starting time in s: 10
- Maximum starting current in % of motor current I_e : 300
- Maximum number of starts per hour in 1/h: 5

In the event of more exacting requirements, it may be necessary to choose a larger device. However, in some cases the de-signed-in safety reserves also permit the listed units to be used in boundary conditions which are slightly more demanding. Detailed technical information for a configuration which is tailored exactly to the application can be found in the manuals. Siemens recommends the use of the selection and simulation program Win-Soft Starter.



SIRIUS 3RW Soft Starters

3RW44 for High-Feature Applications

3RW44

3RW ambient temperature 40 °C						3RW ambient temperature 50 °C				DT	Normal starting (CLASS 10) in inline circuit	PU (UNIT, SET, M)	PS*	PG	
Rated values of induction motors						Rated values of induction motors									
Operational current I_e	Rating at operational voltage U_e					Operational current I_e	Rating at operational voltage U_e				Order No.	Price per PU			
	230 V	400 V	500 V	690 V	1000 V		200 V	230 V	460 V	575 V					
A	kW	kW	kW	kW	kW	A	hp	hp	hp	hp					
Inline circuit, rated operational voltage 400 ... 690 V															
29	--	15	18.5	30	--	26	--	--	15	20	B	3RW44 22-□BC□6	1	1 unit	131
36	--	18.5	22	37	--	32	--	--	20	25	B	3RW44 23-□BC□6	1	1 unit	131
47	--	22	30	45	--	42	--	--	25	30	B	3RW44 24-□BC□6	1	1 unit	131
57	--	30	37	55	--	51	--	--	30	40	B	3RW44 25-□BC□6	1	1 unit	131
77	--	37	45	75	--	68	--	--	50	50	B	3RW44 26-□BC□6	1	1 unit	131
93	--	45	55	90	--	82	--	--	60	75	B	3RW44 27-□BC□6	1	1 unit	131
Order No. supplement for connection types															
• With screw terminals															
• With spring-type terminals															
113	--	55	75	110	--	100	--	--	75	75	B	3RW44 34-□BC□6	1	1 unit	131
134	--	75	90	132	--	117	--	--	75	100	B	3RW44 35-□BC□6	1	1 unit	131
162	--	90	110	160	--	145	--	--	100	125	B	3RW44 36-□BC□6	1	1 unit	131
203	--	110	132	200	--	180	--	--	125	150	B	3RW44 43-□BC□6	1	1 unit	131
250	--	132	160	250	--	215	--	--	150	200	B	3RW44 44-□BC□6	1	1 unit	131
313	--	160	200	315	--	280	--	--	200	250	B	3RW44 45-□BC□6	1	1 unit	131
356	--	200	250	355	--	315	--	--	250	300	B	3RW44 46-□BC□6	1	1 unit	131
432	--	250	315	400	--	385	--	--	300	400	B	3RW44 47-□BC□6	1	1 unit	131
551	--	315	355	560	--	494	--	--	400	500	C	3RW44 53-□BC□6	1	1 unit	131
615	--	355	400	630	--	551	--	--	450	600	C	3RW44 54-□BC□6	1	1 unit	131
693	--	400	500	710	--	615	--	--	500	700	C	3RW44 55-□BC□6	1	1 unit	131
780	--	450	560	800	--	693	--	--	600	750	C	3RW44 56-□BC□6	1	1 unit	131
880	--	500	630	900	--	780	--	--	700	850	C	3RW44 57-□BC□6	1	1 unit	131
970	--	560	710	1000	--	850	--	--	750	900	C	3RW44 58-□BC□6	1	1 unit	131
1076	--	630	800	1100	--	970	--	--	850	1100	C	3RW44 65-□BC□6	1	1 unit	131
1214	--	710	900	1200	--	1076	--	--	950	1200	C	3RW44 66-□BC□6	1	1 unit	131
Order No. supplement for connection types															
• With spring-type terminals															
• With screw terminals															
Order No. supplement for the rated control supply voltage U_s¹⁾															
• 115 V AC															
• 230 V AC															

¹⁾ Control by way of the internal 24 V DC supply and direct control by means of PLC possible.

Note:

The listed motor ratings are rough guide values. The soft starter should always be designed on the basis of the required rated operational current of the motor.

The SIRIUS 3RW44 solid-state soft starters are designed for easy starting conditions. The selection and ordering data were determined for the following boundary conditions (see also the notes on page 4/6):

- Maximum starting time in s: 10
- Maximum starting current in % of motor current I_e : 300
- Maximum number of starts per hour in 1/h: 5

In the event of more exacting requirements, it may be necessary to choose a larger device. However, in some cases the designed-in safety reserves also permit the listed units to be used in boundary conditions which are slightly more demanding. Detailed technical information for a configuration which is tailored exactly to the application can be found in the manuals. Siemens recommends the use of the selection and simulation program Win-Soft Starter.

SIRIUS 3RW Soft Starters

3RW44 for High-Feature Applications

3RW44

SIRIUS 3RW44 for heavy starting (CLASS 20) in inline circuit



3RW ambient temperature 40 °C						3RW ambient temperature 50 °C					DT	Heavy starting (CLASS 20) in inline circuit	PU (UNIT, SET, M)	PS*	PG
Rated values of induction motors						Rated values of induction motors									
Operational current I_e	Rating at operational voltage U_e					Operational current I_e	Rating at operational voltage U_e				Order No.	Price per PU			
	230 V	400 V	500 V	690 V	1000 V		200 V	230 V	460 V	575 V					
A	kW	kW	kW	kW	kW	A	hp	hp	hp	hp					
Inline circuit, rated operational voltage 200 ... 460 V¹⁾															
29	5.5	15	--	--	--	26	7.5	7.5	15	--	▶	3RW44 22-□BC□4	1	1 unit	131
36	7.5	18.5	--	--	--	32	10	10	20	--	▶	3RW44 23-□BC□4	1	1 unit	131
47	11	22	--	--	--	42	10	15	25	--	▶	3RW44 24-□BC□4	1	1 unit	131
57	15	30	--	--	--	51	15	15	30	--	▶	3RW44 25-□BC□4	1	1 unit	131
77	18.5	37	--	--	--	68	20	20	50	--	▶	3RW44 27-□BC□4	1	1 unit	131
Order No. supplement for connection types															
<ul style="list-style-type: none"> • With screw terminals • With spring-type terminals 															
93	22	45	--	--	--	82	25	25	60	--	B	3RW44 34-□BC□4	1	1 unit	131
113	30	55	--	--	--	100	30	30	75	--	B	3RW44 35-□BC□4	1	1 unit	131
134	37	75	--	--	--	117	30	40	75	--	B	3RW44 36-□BC□4	1	1 unit	131
162	45	90	--	--	--	145	40	50	100	--	B	3RW44 43-□BC□4	1	1 unit	131
203	55	110	--	--	--	180	50	60	125	--	B	3RW44 45-□BC□4	1	1 unit	131
250	75	132	--	--	--	215	60	75	150	--	B	3RW44 46-□BC□4	1	1 unit	131
313	90	160	--	--	--	280	75	100	200	--	B	3RW44 47-□BC□4	1	1 unit	131
356	110	200	--	--	--	315	100	125	250	--	B	3RW44 47-□BC□4	1	1 unit	131
432	132	250	--	--	--	385	125	150	300	--	C	3RW44 53-□BC□4	1	1 unit	131
551	160	315	--	--	--	494	150	200	400	--	C	3RW44 53-□BC□4	1	1 unit	131
615	200	355	--	--	--	551	150	200	450	--	C	3RW44 55-□BC□4	1	1 unit	131
693	200	400	--	--	--	615	200	250	500	--	C	3RW44 57-□BC□4	1	1 unit	131
780	250	450	--	--	--	693	200	250	600	--	C	3RW44 65-□BC□4	1	1 unit	131
880	250	500	--	--	--	780	250	300	700	--	C	3RW44 65-□BC□4	1	1 unit	131
970	315	560	--	--	--	850	300	350	750	--	C	3RW44 65-□BC□4	1	1 unit	131
Order No. supplement for connection types															
<ul style="list-style-type: none"> • With spring-type terminals • With screw terminals 															
Order No. supplement for the rated control supply voltage U_s²⁾															
<ul style="list-style-type: none"> • 115 V AC • 230 V AC 															

¹⁾ 3RW44 2. to 3RW44 4. soft starters with screw terminals: delivery time class ▶ (preferred type).

²⁾ Control by way of the internal 24 V DC supply and direct control by means of PLC possible.

Note:

The listed motor ratings are rough guide values. The soft starter should always be designed on the basis of the required rated operational current of the motor.

The SIRIUS 3RW44 solid-state soft starters are designed for easy starting conditions. The selection and ordering data were determined for the following boundary conditions (see also the notes on page 4/6):

- Maximum starting time in s: 40
- Maximum starting current in % of motor current I_e : 350
- Maximum number of starts per hour in 1/h: 1

In the event of more exacting requirements, it may be necessary to choose a larger device. However, in some cases the de-

signed-in safety reserves also permit the listed units to be used in boundary conditions which are slightly more demanding. Detailed technical information for a configuration which is tailored exactly to the application can be found in the manuals. Siemens recommends the use of the selection and simulation program Win-Soft Starter.

* You can order this quantity or a multiple thereof. Illustrations are approximate

SIRIUS 3RW Soft Starters

3RW44 for High-Feature Applications

3RW44

3RW ambient temperature 40 °C						3RW ambient temperature 50 °C				DT	Heavy starting (CLASS 20) in inline circuit	PU (UNIT, SET, M)	PS*	PG	
Rated values of induction motors						Rated values of induction motors									
Operational current I_e	Rating at operational voltage U_e					Operational current I_e	Rating at operational voltage U_e				Order No.	Price per PU			
	230 V	400 V	500 V	690 V	1000 V		200 V	230 V	460 V	575 V					
A	kW	kW	kW	kW	kW	A	hp	hp	hp	hp					
Inline circuit, rated operational voltage 400 ... 600 V¹⁾															
29	--	15	18.5	--	--	26	--	--	15	20	A	3RW44 22-□BC□5	1	1 unit	131
36	--	18.5	22	--	--	32	--	--	20	25	A	3RW44 23-□BC□5	1	1 unit	131
47	--	22	30	--	--	42	--	--	25	30	A	3RW44 24-□BC□5	1	1 unit	131
57	--	30	37	--	--	51	--	--	30	40	A	3RW44 25-□BC□5	1	1 unit	131
77	--	37	45	--	--	68	--	--	50	50	A	3RW44 27-□BC□5	1	1 unit	131
Order No. supplement for connection types															
<ul style="list-style-type: none"> • With screw terminals • With spring-type terminals 															
93	--	45	55	--	--	82	--	--	60	75	B	3RW44 34-□BC□5	1	1 unit	131
113	--	55	75	--	--	100	--	--	75	75	B	3RW44 35-□BC□5	1	1 unit	131
134	--	75	90	--	--	117	--	--	75	100	B	3RW44 36-□BC□5	1	1 unit	131
162	--	90	110	--	--	145	--	--	100	125	B	3RW44 43-□BC□5	1	1 unit	131
203	--	110	132	--	--	180	--	--	125	150	B	3RW44 45-□BC□5	1	1 unit	131
250	--	132	160	--	--	215	--	--	150	200	B	3RW44 46-□BC□5	1	1 unit	131
313	--	160	200	--	--	280	--	--	200	250	B	3RW44 47-□BC□5	1	1 unit	131
356	--	200	250	--	--	315	--	--	250	300	B	3RW44 47-□BC□5	1	1 unit	131
432	--	250	315	--	--	385	--	--	300	400	C	3RW44 53-□BC□5	1	1 unit	131
551	--	315	355	--	--	494	--	--	400	500	C	3RW44 53-□BC□5	1	1 unit	131
615	--	355	400	--	--	551	--	--	450	600	C	3RW44 54-□BC□5	1	1 unit	131
693	--	400	500	--	--	615	--	--	500	700	C	3RW44 57-□BC□5	1	1 unit	131
780	--	450	560	--	--	693	--	--	600	750	C	3RW44 65-□BC□5	1	1 unit	131
880	--	500	630	--	--	780	--	--	700	850	C	3RW44 65-□BC□5	1	1 unit	131
970	--	560	710	--	--	850	--	--	750	900	C	3RW44 65-□BC□5	1	1 unit	131

Order No. supplement for connection types

- With spring-type terminals
- With screw terminals

Order No. supplement for the rated control supply voltage U_s ²⁾

- 115 V AC
- 230 V AC

¹⁾ Soft starter with screw terminals:
 3RW44 2. to 3RW44 4. Delivery time class A,
 3RW44 5. to 3RW44 6. Delivery time class B.

²⁾ Control by way of the internal 24 V DC supply and direct control by means of PLC possible.

Note:

The listed motor ratings are rough guide values. The soft starter should always be designed on the basis of the required rated operational current of the motor.

The SIRIUS 3RW44 solid-state soft starters are designed for easy starting conditions. The selection and ordering data were determined for the following boundary conditions (see also the notes on page 4/6):

- Maximum starting time in s: 40
- Maximum starting current in % of motor current I_e : 350
- Maximum number of starts per hour in 1/h: 1

In the event of more exacting requirements, it may be necessary to choose a larger device. However, in some cases the designed-in safety reserves also permit the listed units to be used in boundary conditions which are slightly more demanding. Detailed technical information for a configuration which is tailored exactly to the application can be found in the manuals. Siemens recommends the use of the selection and simulation program Win-Soft Starter.

SIRIUS 3RW Soft Starters

3RW44 for High-Feature Applications

3RW44

4

3RW ambient temperature 40 °C						3RW ambient temperature 50 °C					DT	Heavy starting (CLASS 20) in inline circuit	PU (UNIT, SET, M)	PS*	PG
Rated values of induction motors						Rated values of induction motors									
Operational current I_e	Rating at operational voltage U_e					Operational current I_e	Rating at operational voltage U_e				Order No.	Price per PU			
	230 V	400 V	500 V	690 V	1000 V		200 V	230 V	460 V	575 V					
A	kW	kW	kW	kW	kW	A	hp	hp	hp	hp					
Inline circuit, rated operational voltage 400 ... 690 V															
29	--	15	18.5	30	--	26	--	--	15	20	B	3RW44 22-□BC□6	1	1 unit	131
36	--	18.5	22	37	--	32	--	--	20	25	B	3RW44 23-□BC□6	1	1 unit	131
47	--	22	30	45	--	42	--	--	25	30	B	3RW44 24-□BC□6	1	1 unit	131
57	--	30	37	55	--	51	--	--	30	40	B	3RW44 25-□BC□6	1	1 unit	131
77	--	37	45	75	--	68	--	--	50	50	B	3RW44 27-□BC□6	1	1 unit	131
Order No. supplement for connection types															
<ul style="list-style-type: none"> • With screw terminals • With spring-type terminals 															
93	--	45	55	90	--	82	--	--	60	75	B	3RW44 34-□BC□6	1	1 unit	131
113	--	55	75	110	--	100	--	--	75	75	B	3RW44 35-□BC□6	1	1 unit	131
134	--	75	90	132	--	117	--	--	75	100	B	3RW44 36-□BC□6	1	1 unit	131
162	--	90	110	160	--	145	--	--	100	125	B	3RW44 43-□BC□6	1	1 unit	131
203	--	110	132	200	--	180	--	--	125	150	B	3RW44 45-□BC□6	1	1 unit	131
250	--	132	160	250	--	215	--	--	150	200	B	3RW44 46-□BC□6	1	1 unit	131
313	--	160	200	315	--	280	--	--	200	250	B	3RW44 47-□BC□6	1	1 unit	131
356	--	200	250	355	--	315	--	--	250	300	B	3RW44 47-□BC□6	1	1 unit	131
432	--	250	315	400	--	385	--	--	300	400	C	3RW44 53-□BC□6	1	1 unit	131
551	--	315	355	560	--	494	--	--	400	500	C	3RW44 53-□BC□6	1	1 unit	131
615	--	355	400	630	--	551	--	--	450	600	C	3RW44 55-□BC□6	1	1 unit	131
693	--	400	500	710	--	615	--	--	500	700	C	3RW44 57-□BC□6	1	1 unit	131
780	--	450	560	800	--	693	--	--	600	750	C	3RW44 65-□BC□6	1	1 unit	131
880	--	500	630	900	--	780	--	--	700	850	C	3RW44 65-□BC□6	1	1 unit	131
970	--	560	710	1 000	--	850	--	--	750	900	C	3RW44 65-□BC□6	1	1 unit	131

Order No. supplement for connection types

- With spring-type terminals
- With screw terminals

Order No. supplement for the rated control supply voltage U_s ¹⁾

- 115 V AC
- 230 V AC

¹⁾ Control by way of the internal 24 V DC supply and direct control by means of PLC possible.

Note:

The listed motor ratings are rough guide values. The soft starter should always be designed on the basis of the required rated operational current of the motor.

The SIRIUS 3RW44 solid-state soft starters are designed for easy starting conditions. The selection and ordering data were determined for the following boundary conditions (see also the notes on page 4/6):

- Maximum starting time in s: 40
- Maximum starting current in % of motor current I_e : 350
- Maximum number of starts per hour in 1/h: 1

In the event of more exacting requirements, it may be necessary to choose a larger device. However, in some cases the designed-in safety reserves also permit the listed units to be used in boundary conditions which are slightly more demanding. Detailed technical information for a configuration which is tailored exactly to the application can be found in the manuals. Siemens recommends the use of the selection and simulation program Win-Soft Starter.

SIRIUS 3RW Soft Starters

3RW44 for High-Feature Applications

3RW44

SIRIUS 3RW44 for very heavy starting (CLASS 30) in inline circuit



3RW44 2.						3RW44 3.					3RW44 4.					3RW44 5.		3RW44 6.	
3RW ambient temperature 40 °C						3RW ambient temperature 50 °C					DT	Very heavy starting (CLASS 30) in inline circuit		PU (UNIT, SET, M)	PS*	PG			
Rated values of induction motors						Rated values of induction motors													
Operational current I_e		Rating at operational voltage U_e				Operational current I_e		Rating at operational voltage U_e			Order No.		Price per PU						
A	230 V	400 V	500 V	690 V	1000 V	A	200 V	230 V	460 V	575 V	hp	hp	hp	hp					
	kW	kW	kW	kW	kW		hp	hp	hp	hp									
Inline circuit, rated operational voltage 200 ... 460 V¹⁾																			
29	5.5	15	--	--	--	26	7.5	7.5	15	--	▶	3RW44 22-□BC□4		1	1 unit	131			
36	7.5	18.5	--	--	--	32	10	10	20	--	▶	3RW44 24-□BC□4		1	1 unit	131			
47	11	22	--	--	--	42	10	15	25	--	▶	3RW44 25-□BC□4		1	1 unit	131			
57	15	30	--	--	--	51	15	15	30	--	▶	3RW44 25-□BC□4		1	1 unit	131			
Order No. supplement for connection types																			
<ul style="list-style-type: none"> • With screw terminals • With spring-type terminals 																			
77	18.5	37	--	--	--	68	20	20	50	--	B	3RW44 34-□BC□4		1	1 unit	131			
93	22	45	--	--	--	82	25	25	60	--	B	3RW44 35-□BC□4		1	1 unit	131			
113	30	55	--	--	--	100	30	30	75	--	B	3RW44 43-□BC□4		1	1 unit	131			
134	37	75	--	--	--	117	30	40	75	--	B	3RW44 43-□BC□4		1	1 unit	131			
162	45	90	--	--	--	145	40	50	100	--	B	3RW44 43-□BC□4		1	1 unit	131			
203	55	110	--	--	--	180	50	60	125	--	B	3RW44 46-□BC□4		1	1 unit	131			
250	75	132	--	--	--	215	60	75	150	--	B	3RW44 47-□BC□4		1	1 unit	131			
313	90	160	--	--	--	280	75	100	200	--	C	3RW44 53-□BC□4		1	1 unit	131			
356	110	200	--	--	--	315	100	125	250	--	C	3RW44 53-□BC□4		1	1 unit	131			
432	132	250	--	--	--	385	125	150	300	--	C	3RW44 53-□BC□4		1	1 unit	131			
551	160	315	--	--	--	494	150	200	400	--	C	3RW44 55-□BC□4		1	1 unit	131			
615	200	355	--	--	--	551	150	200	450	--	C	3RW44 58-□BC□4		1	1 unit	131			
693	200	400	--	--	--	615	200	250	500	--	C	3RW44 65-□BC□4		1	1 unit	131			
780	250	450	--	--	--	693	200	250	600	--	C	3RW44 65-□BC□4		1	1 unit	131			
880	250	500	--	--	--	780	250	300	700	--	C	3RW44 65-□BC□4		1	1 unit	131			
970	315	560	--	--	--	850	300	350	750	--	C	3RW44 66-□BC□4		1	1 unit	131			

Order No. supplement for connection types

- With spring-type terminals
- With screw terminals

Order No. supplement for the rated control supply voltage U_s ²⁾

- 115 V AC
- 230 V AC

¹⁾ 3RW44 2. to 3RW44 4. soft starters with screw terminals: delivery time class ▶ (preferred type).

²⁾ Control by way of the internal 24 V DC supply and direct control by means of PLC possible.

Note:

The listed motor ratings are rough guide values. The soft starter should always be designed on the basis of the required rated operational current of the motor.

The SIRIUS 3RW44 solid-state soft starters are designed for easy starting conditions. The selection and ordering data were determined for the following boundary conditions (see also the notes on page 4/6):

- Maximum starting time in s: 60
- Maximum starting current in % of motor current I_e : 350
- Maximum number of starts per hour in 1/h: 1

In the event of more exacting requirements, it may be necessary to choose a larger device. However, in some cases the de-

signed-in safety reserves also permit the listed units to be used in boundary conditions which are slightly more demanding. Detailed technical information for a configuration which is tailored exactly to the application can be found in the manuals. Siemens recommends the use of the selection and simulation program Win-Soft Starter.

* You can order this quantity or a multiple thereof. Illustrations are approximate

SIRIUS 3RW Soft Starters

3RW44 for High-Feature Applications

3RW44

3RW ambient temperature 40 °C						3RW ambient temperature 50 °C				DT	Very heavy starting (CLASS 30) in inline circuit	PU (UNIT, SET, M)	PS*	PG	
Rated values of induction motors						Rated values of induction motors									
Operational current I_e	Rating at operational voltage U_e					Operational current I_e	Rating at operational voltage U_e				Order No.	Price per PU			
	230 V	400 V	500 V	690 V	1000 V		200 V	230 V	460 V	575 V					
A	kW	kW	kW	kW	kW	A	hp	hp	hp	hp					
Inline circuit, rated operational voltage 400 ... 600 V¹⁾															
29	--	15	18.5	--	--	26	--	--	15	20	A	3RW44 22-□BC□5	1	1 unit	131
36	--	18.5	22	--	--	32	--	--	20	25	A	3RW44 24-□BC□5	1	1 unit	131
47	--	22	30	--	--	42	--	--	25	30	A	3RW44 25-□BC□5	1	1 unit	131
57	--	30	37	--	--	51	--	--	30	40	A	3RW44 25-□BC□5	1	1 unit	131
Order No. supplement for connection types															
<ul style="list-style-type: none"> • With screw terminals • With spring-type terminals 															
77	--	37	45	--	--	68	--	--	50	50	B	3RW44 34-□BC□5	1	1 unit	131
93	--	45	55	--	--	82	--	--	60	75	B	3RW44 35-□BC□5	1	1 unit	131
113	--	55	75	--	--	100	--	--	75	75	B	3RW44 43-□BC□5	1	1 unit	131
134	--	75	90	--	--	117	--	--	75	100	B	3RW44 43-□BC□5	1	1 unit	131
162	--	90	110	--	--	145	--	--	100	125	B	3RW44 43-□BC□5	1	1 unit	131
203	--	110	132	--	--	180	--	--	125	150	B	3RW44 46-□BC□5	1	1 unit	131
250	--	132	160	--	--	215	--	--	150	200	B	3RW44 47-□BC□5	1	1 unit	131
313	--	160	200	--	--	280	--	--	200	250	C	3RW44 53-□BC□5	1	1 unit	131
356	--	200	250	--	--	315	--	--	250	300	C	3RW44 53-□BC□5	1	1 unit	131
432	--	250	315	--	--	385	--	--	300	400	C	3RW44 53-□BC□5	1	1 unit	131
551	--	315	355	--	--	494	--	--	400	500	C	3RW44 55-□BC□5	1	1 unit	131
615	--	355	400	--	--	551	--	--	450	600	C	3RW44 58-□BC□5	1	1 unit	131
693	--	400	500	--	--	615	--	--	500	700	C	3RW44 65-□BC□5	1	1 unit	131
780	--	450	560	--	--	693	--	--	600	750	C	3RW44 65-□BC□5	1	1 unit	131
880	--	500	630	--	--	780	--	--	700	850	C	3RW44 65-□BC□5	1	1 unit	131
--	--	--	--	--	--	850	--	--	750	900	C	3RW44 66-□BC□5	1	1 unit	131

Order No. supplement for connection types

- With spring-type terminals
- With screw terminals

Order No. supplement for the rated control supply voltage U_s ²⁾

- 115 V AC
- 230 V AC

¹⁾ Soft starter with screw terminals:
 3RW44 2. to 3RW44 4. Delivery time class A,
 3RW44 5. to 3RW44 6. Delivery time class B.

²⁾ Control by way of the internal 24 V DC supply and direct control by means of PLC possible.

Note:

The listed motor ratings are rough guide values. The soft starter should always be designed on the basis of the required rated operational current of the motor.

The SIRIUS 3RW44 solid-state soft starters are designed for easy starting conditions. The selection and ordering data were determined for the following boundary conditions (see also the notes on page 4/6):

- Maximum starting time in s: 60
- Maximum starting current in % of motor current I_e : 350
- Maximum number of starts per hour in 1/h: 1

In the event of more exacting requirements, it may be necessary to choose a larger device. However, in some cases the designed-in safety reserves also permit the listed units to be used in boundary conditions which are slightly more demanding. Detailed technical information for a configuration which is tailored exactly to the application can be found in the manuals. Siemens recommends the use of the selection and simulation program Win-Soft Starter.

SIRIUS 3RW Soft Starters

3RW44 for High-Feature Applications

3RW44

3RW ambient temperature 40 °C						3RW ambient temperature 50 °C					DT	Very heavy starting (CLASS 30) in inline circuit	PU (UNIT, SET, M)	PS*	PG
Rated values of induction motors						Rated values of induction motors									
Operational current I_e	Rating at operational voltage U_e					Operational current I_e	Rating at operational voltage U_e				Order No.	Price per PU			
	230 V	400 V	500 V	690 V	1000 V		200 V	230 V	460 V	575 V					
A	kW	kW	kW	kW	kW	A	hp	hp	hp	hp					
Inline circuit, rated operational voltage 400 ... 690 V															
29	--	15	18.5	30	--	26	--	--	15	20	B	3RW44 22-□BC□6	1	1 unit	131
36	--	18.5	22	37	--	32	--	--	20	25	B	3RW44 24-□BC□6	1	1 unit	131
47	--	22	30	45	--	42	--	--	25	30	B	3RW44 25-□BC□6	1	1 unit	131
57	--	30	37	55	--	51	--	--	30	40	B	3RW44 25-□BC□6	1	1 unit	131
Order No. supplement for connection types															
<ul style="list-style-type: none"> • With screw terminals • With spring-type terminals 															
77	--	37	45	75	--	68	--	--	50	50	B	3RW44 34-□BC□6	1	1 unit	131
93	--	45	55	90	--	82	--	--	60	75	B	3RW44 35-□BC□6	1	1 unit	131
113	--	55	75	110	--	100	--	--	75	75	B	3RW44 43-□BC□6	1	1 unit	131
134	--	75	90	132	--	117	--	--	75	100	B	3RW44 43-□BC□6	1	1 unit	131
162	--	90	110	160	--	145	--	--	100	125	B	3RW44 43-□BC□6	1	1 unit	131
203	--	110	132	200	--	180	--	--	125	150	B	3RW44 46-□BC□6	1	1 unit	131
250	--	132	160	250	--	215	--	--	150	200	B	3RW44 47-□BC□6	1	1 unit	131
313	--	160	200	315	--	280	--	--	200	250	C	3RW44 53-□BC□6	1	1 unit	131
356	--	200	250	355	--	315	--	--	250	300	C	3RW44 53-□BC□6	1	1 unit	131
432	--	250	315	400	--	385	--	--	300	400	C	3RW44 53-□BC□6	1	1 unit	131
551	--	315	355	560	--	494	--	--	400	500	C	3RW44 55-□BC□6	1	1 unit	131
615	--	355	400	630	--	551	--	--	450	600	C	3RW44 58-□BC□6	1	1 unit	131
693	--	400	500	710	--	615	--	--	500	700	C	3RW44 65-□BC□6	1	1 unit	131
780	--	450	560	800	--	693	--	--	600	750	C	3RW44 65-□BC□6	1	1 unit	131
880	--	500	630	900	--	780	--	--	700	850	C	3RW44 65-□BC□6	1	1 unit	131
--	--	--	--	--	--	850	--	--	750	900	C	3RW44 66-□BC□6	1	1 unit	131

Order No. supplement for connection types

- With spring-type terminals
- With screw terminals

Order No. supplement for the rated control supply voltage U_s ¹⁾

- 115 V AC
- 230 V AC

¹⁾ Control by way of the internal 24 V DC supply and direct control by means of PLC possible.

Note:

The listed motor ratings are rough guide values. The soft starter should always be designed on the basis of the required rated operational current of the motor.

The SIRIUS 3RW44 solid-state soft starters are designed for easy starting conditions. The selection and ordering data were determined for the following boundary conditions (see also the notes on page 4/6):

- Maximum starting time in s: 60
- Maximum starting current in % of motor current I_e : 350
- Maximum number of starts per hour in 1/h: 1

In the event of more exacting requirements, it may be necessary to choose a larger device. However, in some cases the designed-in safety reserves also permit the listed units to be used in boundary conditions which are slightly more demanding. Detailed technical information for a configuration which is tailored exactly to the application can be found in the manuals. Siemens recommends the use of the selection and simulation program Win-Soft Starter.

SIRIUS 3RW Soft Starters

3RW44 for High-Feature Applications

3RW44

SIRIUS 3RW44 for normal starting (CLASS 10) in inside-delta circuit



3RW44 2.					3RW44 3.					3RW44 4.					3RW44 5.		3RW44 6.																																																																														
3RW ambient temperature 40 °C ¹⁾										3RW ambient temperature 50 °C ¹⁾										DT	Normal starting (CLASS 10) in inside-delta circuit	PU (UNIT, SET, M)	PS*	PG																																																																							
Rated values of induction motors										Rated values of induction motors																																																																																					
Operational current I _e		Rating at operational voltage U _e								Operational current I _e		Rating at operational voltage U _e								Order No.		Price per PU																																																																									
A		230 V	400 V	500 V	690 V	1000 V						A	200 V	230 V	460 V	575 V																																																																															
		kW	kW	kW	kW	kW							hp	hp	hp	hp																																																																															
Inside-delta circuit, rated operational voltage 200 ... 460 V²⁾																																																																																															
50	15	22	--	--	--	45	10	15	30	--	▶	3RW44 22-□BC□4	1	1 unit	131	62	18.5	30	--	--	--	55	15	20	40	--	▶	3RW44 23-□BC□4	1	1 unit	131	81	22	45	--	--	--	73	20	25	50	--	▶	3RW44 24-□BC□4	1	1 unit	131	99	30	55	--	--	--	88	25	30	60	--	▶	3RW44 25-□BC□4	1	1 unit	131	133	37	75	--	--	--	118	30	40	75	--	▶	3RW44 26-□BC□4	1	1 unit	131	161	45	90	--	--	--	142	40	50	100	--	▶	3RW44 27-□BC□4	1	1 unit	131
Order No. supplement for connection types																																																																																															
• With screw terminals																																																																																															
• With spring-type terminals																																																																																															
196	55	110	--	--	--	173	50	60	125	--	B	3RW44 34-□BC□4	1	1 unit	131	232	75	132	--	--	--	203	60	75	150	--	B	3RW44 35-□BC□4	1	1 unit	131	281	90	160	--	--	--	251	75	100	200	--	B	3RW44 36-□BC□4	1	1 unit	131																																																
352	110	200	--	--	--	312	100	125	250	--	B	3RW44 43-□BC□4	1	1 unit	131	433	132	250	--	--	--	372	125	150	300	--	B	3RW44 44-□BC□4	1	1 unit	131	542	160	315	--	--	--	485	150	200	400	--	B	3RW44 45-□BC□4	1	1 unit	131																																																
617	200	355	--	--	--	546	150	200	450	--	B	3RW44 46-□BC□4	1	1 unit	131	748	250	400	--	--	--	667	200	250	600	--	B	3RW44 47-□BC□4	1	1 unit	131																																																																
954	315	560	--	--	--	856	300	350	750	--	C	3RW44 53-□BC□4	1	1 unit	131	1065	355	630	--	--	--	954	350	400	850	--	C	3RW44 54-□BC□4	1	1 unit	131	1200	400	710	--	--	--	1065	350	450	950	--	C	3RW44 55-□BC□4	1	1 unit	131																																																
1351	450	800	--	--	--	1200	450	500	1050	--	C	3RW44 56-□BC□4	1	1 unit	131	1524	500	900	--	--	--	1351	450	600	1200	--	C	3RW44 57-□BC□4	1	1 unit	131	1680	560	1000	--	--	--	1472	550	650	1300	--	C	3RW44 58-□BC□4	1	1 unit	131																																																
1864	630	1100	--	--	--	1680	650	750	1500	--	C	3RW44 65-□BC□4	1	1 unit	131	2103	710	1200	--	--	--	1864	700	850	1700	--	C	3RW44 66-□BC□4	1	1 unit	131																																																																

Order No. supplement for connection types

- With spring-type terminals
- With screw terminals

Order No. supplement for the rated control supply voltage U_s³⁾

- 115 V AC
- 230 V AC

¹⁾ In the selection table, the unit rated current I_e refers to the induction motor's rated operational current in the inside-delta circuit. The actual current of the device is approx. 58 % of this value.

²⁾ 3RW44 2. to 3RW44 4. soft starters with screw terminals: delivery time class ▶ (preferred type).

³⁾ Control by way of the internal 24 V DC supply and direct control by means of PLC possible.

Note:

The listed motor ratings are rough guide values. The soft starter should always be designed on the basis of the required rated operational current of the motor.

The SIRIUS 3RW44 solid-state soft starters are designed for easy starting conditions. The selection and ordering data were determined for the following boundary conditions (see also the notes on page 4/6):

- Maximum starting time in s: 10
- Maximum starting current in % of motor current I_e: 300
- Maximum number of starts per hour in 1/h: 5

In the event of more exacting requirements, it may be necessary to choose a larger device. However, in some cases the designed-in safety reserves also permit the listed units to be used in boundary conditions which are slightly more demanding. Detailed technical information for a configuration which is tailored exactly to the application can be found in the manuals. Siemens recommends the use of the selection and simulation program Win-Soft Starter.

SIRIUS 3RW Soft Starters

3RW44 for High-Feature Applications

3RW44

3RW ambient temperature 40 °C ¹⁾						3RW ambient temperature 50 °C ¹⁾				DT	Normal starting (CLASS 10) in inside-delta circuit	PU (UNIT, SET, M)	PS*	PG		
Rated values of induction motors						Rated values of induction motors										
Operational current I _e	Rating at operational voltage U _e					Operational current I _e	Rating at operational voltage U _e				Order No.	Price per PU				
	230 V	400 V	500 V	690 V	1000 V		200 V	230 V	460 V	575 V						
A	kW	kW	kW	kW	kW	A	hp	hp	hp	hp						
Inside-delta circuit, rated operational voltage 400 ... 600 V²⁾																
50	--	22	30	--	--	45	--	--	30	40	A	3RW44 22-□BC□5	1	1 unit	131	
62	--	30	37	--	--	55	--	--	40	50	A	3RW44 23-□BC□5	1	1 unit	131	
81	--	45	45	--	--	73	--	--	50	60	A	3RW44 24-□BC□5	1	1 unit	131	
99	--	55	55	--	--	88	--	--	60	75	A	3RW44 25-□BC□5	1	1 unit	131	
133	--	75	90	--	--	118	--	--	75	100	A	3RW44 26-□BC□5	1	1 unit	131	
161	--	90	110	--	--	142	--	--	100	125	A	3RW44 27-□BC□5	1	1 unit	131	
Order No. supplement for connection types																
<ul style="list-style-type: none"> • With screw terminals • With spring-type terminals 																
196	--	110	132	--	--	173	--	--	125	150	B	3RW44 34-□BC□5	1	1 unit	131	
232	--	132	160	--	--	203	--	--	150	200	B	3RW44 35-□BC□5	1	1 unit	131	
281	--	160	200	--	--	251	--	--	200	250	B	3RW44 36-□BC□5	1	1 unit	131	
352	--	200	250	--	--	312	--	--	250	300	B	3RW44 43-□BC□5	1	1 unit	131	
433	--	250	315	--	--	372	--	--	300	350	B	3RW44 44-□BC□5	1	1 unit	131	
542	--	315	355	--	--	485	--	--	400	500	B	3RW44 45-□BC□5	1	1 unit	131	
617	--	355	450	--	--	546	--	--	450	600	B	3RW44 46-□BC□5	1	1 unit	131	
748	--	400	500	--	--	667	--	--	600	750	B	3RW44 47-□BC□5	1	1 unit	131	
954	--	560	630	--	--	856	--	--	750	950	C	3RW44 53-□BC□5	1	1 unit	131	
1 065	--	630	710	--	--	954	--	--	850	1 050	C	3RW44 54-□BC□5	1	1 unit	131	
1 200	--	710	800	--	--	1 065	--	--	950	1 200	C	3RW44 55-□BC□5	1	1 unit	131	
1 351	--	800	900	--	--	1 200	--	--	1 050	1 350	C	3RW44 56-□BC□5	1	1 unit	131	
1 524	--	900	1 000	--	--	1 351	--	--	1 200	1 500	C	3RW44 57-□BC□5	1	1 unit	131	
1 680	--	1 000	1 200	--	--	1 472	--	--	1 300	1 650	C	3RW44 58-□BC□5	1	1 unit	131	
1 864	--	1 100	1 350	--	--	1 680	--	--	1 500	1 900	C	3RW44 65-□BC□5	1	1 unit	131	
2 103	--	1 200	1 500	--	--	1 864	--	--	1 700	2 100	C	3RW44 66-□BC□5	1	1 unit	131	

Order No. supplement for connection types

- With spring-type terminals
- With screw terminals

Order No. supplement for the rated control supply voltage U_s³⁾

- 115 V AC
- 230 V AC

¹⁾ In the selection table, the unit rated current I_e refers to the induction motor's rated operational current in the inside-delta circuit. The actual current of the device is approx. 58 % of this value.

²⁾ Soft starter with screw terminals: 3RW44 2. to 3RW44 4. Delivery time class A, 3RW44 5. to 3RW44 6. Delivery time class B.

³⁾ Control by way of the internal 24 V DC supply and direct control by means of PLC possible.

Note:

The listed motor ratings are rough guide values. The soft starter should always be designed on the basis of the required rated operational current of the motor.

The SIRIUS 3RW44 solid-state soft starters are designed for easy starting conditions. The selection and ordering data were determined for the following boundary conditions (see also the notes on page 4/6):

- Maximum starting time in s: 10
- Maximum starting current in % of motor current I_e: 300
- Maximum number of starts per hour in 1/h: 5

In the event of more exacting requirements, it may be necessary to choose a larger device. However, in some cases the de-signed-in safety reserves also permit the listed units to be used in boundary conditions which are slightly more demanding. Detailed technical information for a configuration which is tailored exactly to the application can be found in the manuals. Siemens recommends the use of the selection and simulation program Win-Soft Starter.

SIRIUS 3RW Soft Starters

3RW44 for High-Feature Applications

3RW44

SIRIUS 3RW44 for heavy starting (CLASS 20) in inside-delta circuit



3RW44 2.						3RW44 3.				3RW44 4.				3RW44 5.		3RW44 6.	
3RW ambient temperature 40 °C ¹⁾						3RW ambient temperature 50 °C ¹⁾				DT	Heavy starting (CLASS 20) in inside-delta circuit		PU (UNIT, SET, M)	PS*	PG		
Rated values of induction motors						Rated values of induction motors											
Operational current I _e		Rating at operational voltage U _e				Operational current I _e		Rating at operational voltage U _e									
		230 V	400 V	500 V	690 V	1000 V			200 V	230 V	460 V	575 V	Order No.	Price per PU			
A	kW	kW	kW	kW	kW	A	hp	hp	hp	hp							

Inside-delta circuit, rated operational voltage 200 ... 460 V ²⁾															
50	15	22	--	--	--	45	10	15	30	--	▶	3RW44 23-□BC□4	1	1 unit	131
62	18.5	30	--	--	--	55	15	20	40	--	▶	3RW44 24-□BC□4	1	1 unit	131
81	22	45	--	--	--	73	20	25	50	--	▶	3RW44 25-□BC□4	1	1 unit	131
99	30	55	--	--	--	88	25	30	60	--	▶	3RW44 25-□BC□4	1	1 unit	131
133	37	75	--	--	--	118	30	40	75	--	▶	3RW44 27-□BC□4	1	1 unit	131

Order No. supplement for connection types

- With screw terminals
- With spring-type terminals

161	45	90	--	--	--	142	40	50	100	--	B	3RW44 34-□BC□4	1	1 unit	131
196	55	110	--	--	--	173	50	60	125	--	B	3RW44 35-□BC□4	1	1 unit	131
232	75	132	--	--	--	203	60	75	150	--	B	3RW44 36-□BC□4	1	1 unit	131
281	90	160	--	--	--	251	75	100	200	--	B	3RW44 43-□BC□4	1	1 unit	131
352	110	200	--	--	--	312	100	125	250	--	B	3RW44 44-□BC□4	1	1 unit	131
433	132	250	--	--	--	372	125	150	300	--	B	3RW44 45-□BC□4	1	1 unit	131
542	160	315	--	--	--	485	150	200	400	--	B	3RW44 47-□BC□4	1	1 unit	131
617	200	355	--	--	--	546	150	200	450	--	B	3RW44 47-□BC□4	1	1 unit	131
748	250	400	--	--	--	667	200	250	600	--	C	3RW44 53-□BC□4	1	1 unit	131
954	315	560	--	--	--	856	300	350	750	--	C	3RW44 53-□BC□4	1	1 unit	131
1 065	355	630	--	--	--	954	350	400	850	--	C	3RW44 55-□BC□4	1	1 unit	131
1 200	400	710	--	--	--	1 065	350	450	950	--	C	3RW44 57-□BC□4	1	1 unit	131
1 351	450	800	--	--	--	1 200	450	500	1 050	--	C	3RW44 65-□BC□4	1	1 unit	131
1 524	500	900	--	--	--	1 351	450	600	1 200	--	C	3RW44 65-□BC□4	1	1 unit	131
1 680	560	1 000	--	--	--	1 472	550	650	1 300	--	C	3RW44 65-□BC□4	1	1 unit	131
--	--	--	--	--	--	1 680	650	750	1 500	--	C	3RW44 66-□BC□4	1	1 unit	131

Order No. supplement for connection types

- With spring-type terminals
- With screw terminals

Order No. supplement for the rated control supply voltage U_s³⁾

- 115 V AC
- 230 V AC

¹⁾ In the selection table, the unit rated current I_e refers to the induction motor's rated operational current in the inside-delta circuit. The actual current of the device is approx. 58 % of this value.

²⁾ 3RW44 2. to 3RW44 4. soft starters with screw terminals: delivery time class ▶ (preferred type).

³⁾ Control by way of the internal 24 V DC supply and direct control by means of PLC possible.

Note:

The listed motor ratings are rough guide values. The soft starter should always be designed on the basis of the required rated operational current of the motor.

The SIRIUS 3RW44 solid-state soft starters are designed for easy starting conditions. The selection and ordering data were determined for the following boundary conditions (see also the notes on page 4/6):

- Maximum starting time in s: 40
- Maximum starting current in % of motor current I_e: 350

• Maximum number of starts per hour in 1/h: 1
 In the event of more exacting requirements, it may be necessary to choose a larger device. However, in some cases the designed-in safety reserves also permit the listed units to be used in boundary conditions which are slightly more demanding. Detailed technical information for a configuration which is tailored exactly to the application can be found in the manuals. Siemens recommends the use of the selection and simulation program Win-Soft Starter.

* You can order this quantity or a multiple thereof. Illustrations are approximate

SIRIUS 3RW Soft Starters

3RW44 for High-Feature Applications

3RW44

3RW ambient temperature 40 °C ¹⁾					3RW ambient temperature 50 °C ¹⁾					DT	Heavy starting (CLASS 20) in inside-delta circuit	PU (UNIT, SET, M)	PS*	PG	
Rated values of induction motors					Rated values of induction motors										
Operational current I _e	Rating at operational voltage U _e					Operational current I _e	Rating at operational voltage U _e					Order No.	Price per PU		
	230 V	400 V	500 V	690 V	1000 V		200 V	230 V	460 V	575 V					
A	kW	kW	kW	kW	kW	A	hp	hp	hp	hp					
Inside-delta circuit, rated operational voltage 400 ... 600 V²⁾															
50	--	22	30	--	--	45	--	--	30	40	A	3RW44 23-□BC□5	1	1 unit	131
62	--	30	37	--	--	55	--	--	40	50	A	3RW44 24-□BC□5	1	1 unit	131
81	--	45	45	--	--	73	--	--	50	60	A	3RW44 25-□BC□5	1	1 unit	131
99	--	55	55	--	--	88	--	--	60	75	A	3RW44 25-□BC□5	1	1 unit	131
133	--	75	90	--	--	118	--	--	75	100	A	3RW44 27-□BC□5	1	1 unit	131
Order No. supplement for connection types															
<ul style="list-style-type: none"> • With screw terminals • With spring-type terminals 															
161	--	90	110	--	--	142	--	--	100	125	B	3RW44 34-□BC□5	1	1 unit	131
196	--	110	132	--	--	173	--	--	125	150	B	3RW44 35-□BC□5	1	1 unit	131
232	--	132	160	--	--	203	--	--	150	200	B	3RW44 36-□BC□5	1	1 unit	131
281	--	160	200	--	--	251	--	--	200	250	B	3RW44 43-□BC□5	1	1 unit	131
352	--	200	250	--	--	312	--	--	250	300	B	3RW44 44-□BC□5	1	1 unit	131
433	--	250	315	--	--	372	--	--	300	350	B	3RW44 45-□BC□5	1	1 unit	131
542	--	315	355	--	--	485	--	--	400	500	B	3RW44 47-□BC□5	1	1 unit	131
617	--	355	450	--	--	546	--	--	450	600	B	3RW44 47-□BC□5	1	1 unit	131
748	--	400	500	--	--	667	--	--	600	750	C	3RW44 53-□BC□5	1	1 unit	131
954	--	560	630	--	--	856	--	--	750	950	C	3RW44 53-□BC□5	1	1 unit	131
1 065	--	630	710	--	--	954	--	--	850	1 050	C	3RW44 55-□BC□5	1	1 unit	131
1 200	--	710	800	--	--	1 065	--	--	950	1 200	C	3RW44 57-□BC□5	1	1 unit	131
1 351	--	800	900	--	--	1 200	--	--	1 050	1 350	C	3RW44 65-□BC□5	1	1 unit	131
1 524	--	900	1 000	--	--	1 351	--	--	1 200	1 500	C	3RW44 65-□BC□5	1	1 unit	131
1 680	--	1 000	1 200	--	--	1 472	--	--	1 300	1 650	C	3RW44 65-□BC□5	1	1 unit	131
--	--	--	--	--	--	1 680	--	--	1 500	1 900	C	3RW44 66-□BC□5	1	1 unit	131
Order No. supplement for connection types															
<ul style="list-style-type: none"> • With spring-type terminals • With screw terminals 															
Order No. supplement for the rated control supply voltage U_s³⁾															
<ul style="list-style-type: none"> • 115 V AC • 230 V AC 															

¹⁾ In the selection table, the unit rated current I_e refers to the induction motor's rated operational current in the inside-delta circuit. The actual current of the device is approx. 58 % of this value.

²⁾ Soft starter with screw terminals: 3RW44 2. to 3RW44 4. Delivery time class A, 3RW44 5. to 3RW44 6. Delivery time class B.

³⁾ Control by way of the internal 24 V DC supply and direct control by means of PLC possible.

Note:

The listed motor ratings are rough guide values. The soft starter should always be designed on the basis of the required rated operational current of the motor.

The SIRIUS 3RW44 solid-state soft starters are designed for easy starting conditions. The selection and ordering data were determined for the following boundary conditions (see also the notes on page 4/6):

- Maximum starting time in s: 40
- Maximum starting current in % of motor current I_e: 350
- Maximum number of starts per hour in 1/h: 1

In the event of more exacting requirements, it may be necessary to choose a larger device. However, in some cases the designed-in safety reserves also permit the listed units to be used in boundary conditions which are slightly more demanding. Detailed technical information for a configuration which is tailored exactly to the application can be found in the manuals. Siemens recommends the use of the selection and simulation program Win-Soft Starter.

SIRIUS 3RW Soft Starters

3RW44 for High-Feature Applications

3RW44

SIRIUS 3RW44 for very heavy starting (CLASS 30) in inside-delta circuit



3RW ambient temperature 40 °C ¹⁾						3RW ambient temperature 50 °C ¹⁾				DT	Very heavy starting (CLASS 30) in inside-delta circuit	PU (UNIT, SET, M)	PS*	PG		
Rated values of induction motors						Rated values of induction motors										
Operational current I _e	Rating at operational voltage U _e					Operational current I _e	Rating at operational voltage U _e				Order No.	Price per PU				
	230 V	400 V	500 V	690 V	1000 V		200 V	230 V	460 V	575 V						
A	kW	kW	kW	kW	kW	A	hp	hp	hp	hp						
Inside-delta circuit, rated operational voltage 200 ... 460 V²⁾																
50	15	22	--	--	--	45	10	15	30	--	▶	3RW44 23-□BC□4	1	1 unit	131	
62	18.5	30	--	--	--	55	15	20	40	--	▶	3RW44 24-□BC□4	1	1 unit	131	
81	22	45	--	--	--	73	20	25	50	--	▶	3RW44 25-□BC□4	1	1 unit	131	
99	30	55	--	--	--	88	25	30	60	--	▶	3RW44 25-□BC□4	1	1 unit	131	
133	37	75	--	--	--	118	30	40	75	--	▶	3RW44 27-□BC□4	1	1 unit	131	
Order No. supplement for connection types																
<ul style="list-style-type: none"> • With screw terminals • With spring-type terminals 																
161	45	90	--	--	--	142	40	50	100	--	B	3RW44 35-□BC□4	1	1 unit	131	
196	55	110	--	--	--	173	50	60	125	--	B	3RW44 36-□BC□4	1	1 unit	131	
232	75	132	--	--	--	203	60	75	150	--	B	3RW44 43-□BC□4	1	1 unit	131	
281	90	160	--	--	--	251	75	100	200	--	B	3RW44 43-□BC□4	1	1 unit	131	
352	110	200	--	--	--	312	100	125	250	--	B	3RW44 45-□BC□4	1	1 unit	131	
433	132	250	--	--	--	372	125	150	300	--	B	3RW44 47-□BC□4	1	1 unit	131	
542	160	315	--	--	--	485	150	200	400	--	C	3RW44 53-□BC□4	1	1 unit	131	
617	200	355	--	--	--	546	150	200	450	--	C	3RW44 53-□BC□4	1	1 unit	131	
748	250	400	--	--	--	667	200	250	600	--	C	3RW44 53-□BC□4	1	1 unit	131	
954	315	560	--	--	--	856	300	350	750	--	C	3RW44 55-□BC□4	1	1 unit	131	
1 065	355	630	--	--	--	954	350	400	850	--	C	3RW44 58-□BC□4	1	1 unit	131	
1 200	400	710	--	--	--	1 065	350	450	950	--	C	3RW44 65-□BC□4	1	1 unit	131	
1 351	450	800	--	--	--	1 200	450	500	1 050	--	C	3RW44 65-□BC□4	1	1 unit	131	
1 524	500	900	--	--	--	1 351	450	600	1 200	--	C	3RW44 65-□BC□4	1	1 unit	131	
--	--	--	--	--	--	1 472	550	650	1 300	--	C	3RW44 66-□BC□4	1	1 unit	131	
Order No. supplement for connection types																
<ul style="list-style-type: none"> • With spring-type terminals • With screw terminals 																
Order No. supplement for the rated control supply voltage U_s³⁾																
<ul style="list-style-type: none"> • 115 V AC • 230 V AC 																

¹⁾ In the selection table, the unit rated current I_e refers to the induction motor's rated operational current in the inside-delta circuit. The actual current of the device is approx. 58 % of this value.

²⁾ 3RW44 2..to 3RW44 4.. soft starters with screw terminals: delivery time class ▶ (preferred type).

³⁾ Control by way of the internal 24 V DC supply and direct control by means of PLC possible.

Note:

The listed motor ratings are rough guide values. The soft starter should always be designed on the basis of the required rated operational current of the motor.

The SIRIUS 3RW44 solid-state soft starters are designed for easy starting conditions. The selection and ordering data were determined for the following boundary conditions (see also the notes on page 4/6):

- Maximum starting time in s: 60
- Maximum starting current in % of motor current I_e: 350
- Maximum number of starts per hour in 1/h: 1

In the event of more exacting requirements, it may be necessary to choose a larger device. However, in some cases the designed-in safety reserves also permit the listed units to be used in boundary conditions which are slightly more demanding. Detailed technical information for a configuration which is tailored exactly to the application can be found in the manuals. Siemens recommends the use of the selection and simulation program Win-Soft Starter.

SIRIUS 3RW Soft Starters

3RW44 for High-Feature Applications

3RW44

3RW ambient temperature 40 °C ¹⁾					3RW ambient temperature 50 °C ¹⁾					DT	Very heavy starting (CLASS 30) in inside-delta circuit	PU (UNIT, SET, M)	PS*	PG	
Rated values of induction motors					Rated values of induction motors										
Operational current I _e	Rating at operational voltage U _e					Operational current I _e	Rating at operational voltage U _e					Order No.	Price per PU		
	230 V	400 V	500 V	690 V	1000 V		200 V	230 V	460 V	575 V					
A	kW	kW	kW	kW	kW	A	hp	hp	hp	hp					
Inside-delta circuit, rated operational voltage 400 ... 600 V²⁾															
50	--	22	30	--	--	45	--	--	30	40	A	3RW44 23-□BC□5	1	1 unit	131
62	--	30	37	--	--	55	--	--	40	50	A	3RW44 24-□BC□5	1	1 unit	131
81	--	45	45	--	--	73	--	--	50	60	A	3RW44 25-□BC□5	1	1 unit	131
99	--	55	55	--	--	88	--	--	60	75	A	3RW44 25-□BC□5	1	1 unit	131
133	--	75	90	--	--	118	--	--	75	100	A	3RW44 27-□BC□5	1	1 unit	131
Order No. supplement for connection types															
<ul style="list-style-type: none"> • With screw terminals • With spring-type terminals 															
161	--	90	110	--	--	142	--	--	100	125	B	3RW44 35-□BC□5	1	1 unit	131
196	--	110	132	--	--	173	--	--	125	150	B	3RW44 36-□BC□5	1	1 unit	131
232	--	132	160	--	--	203	--	--	150	200	B	3RW44 43-□BC□5	1	1 unit	131
281	--	160	200	--	--	251	--	--	200	250	B	3RW44 43-□BC□5	1	1 unit	131
352	--	200	250	--	--	312	--	--	250	300	B	3RW44 45-□BC□5	1	1 unit	131
433	--	250	315	--	--	372	--	--	300	350	B	3RW44 47-□BC□5	1	1 unit	131
542	--	315	355	--	--	485	--	--	400	500	C	3RW44 53-□BC□5	1	1 unit	131
617	--	355	450	--	--	546	--	--	450	600	C	3RW44 53-□BC□5	1	1 unit	131
748	--	400	500	--	--	667	--	--	600	750	C	3RW44 53-□BC□5	1	1 unit	131
954	--	560	630	--	--	856	--	--	750	950	C	3RW44 55-□BC□5	1	1 unit	131
1 065	--	630	710	--	--	954	--	--	850	1 050	C	3RW44 58-□BC□5	1	1 unit	131
1 200	--	710	800	--	--	1 065	--	--	950	1 200	C	3RW44 65-□BC□5	1	1 unit	131
1 351	--	800	900	--	--	1 200	--	--	1 050	1 350	C	3RW44 65-□BC□5	1	1 unit	131
1 524	--	900	1 000	--	--	1 351	--	--	1 200	1 500	C	3RW44 65-□BC□5	1	1 unit	131
--	--	--	--	--	--	1 472	--	--	1 300	1 650	C	3RW44 66-□BC□5	1	1 unit	131

Order No. supplement for connection types

- With spring-type terminals
- With screw terminals

Order No. supplement for the rated control supply voltage U_s³⁾

- 115 V AC
- 230 V AC

¹⁾ In the selection table, the unit rated current I_e refers to the induction motor's rated operational current in the inside-delta circuit. The actual current of the device is approx. 58 % of this value.

²⁾ Soft starter with screw terminals: 3RW44 2. to 3RW44 4. Delivery time class A, 3RW44 5. to 3RW44 6. Delivery time class B.

³⁾ Control by way of the internal 24 V DC supply and direct control by means of PLC possible.

Note:

The listed motor ratings are rough guide values. The soft starter should always be designed on the basis of the required rated operational current of the motor.

The SIRIUS 3RW44 solid-state soft starters are designed for easy starting conditions. The selection and ordering data were determined for the following boundary conditions (see also the notes on page 4/6):

- Maximum starting time in s: 60
- Maximum starting current in % of motor current I_e: 350
- Maximum number of starts per hour in 1/h: 1



In the event of more exacting requirements, it may be necessary to choose a larger device. However, in some cases the de-signed-in safety reserves also permit the listed units to be used in boundary conditions which are slightly more demanding. Detailed technical information for a configuration which is tailored exactly to the application can be found in the manuals. Siemens recommends the use of the selection and simulation program Win-Soft Starter.

SIRIUS 3RW Soft Starters

3RW44 for High-Feature Applications

3RW44

Accessories



Version	DT	Order No.	Price per PU	PU (UNIT, SET, M)	PS*	PG
Soft Starter ES 2007 PC communication program¹⁾						
	Soft Starter ES 2007 Basic Floating license for one user E-SW, software and documentation on CD, 3 languages (German/English/French), communication through system interface • License key on USB stick, Class A, including CD		B	3ZS1 313-4CC10-0YA5	1	1 unit 131
	Soft Starter ES 2007 Standard Floating license for one user E-SW, software and documentation on CD, 3 languages (German/English/French), communication through system interface • License key on USB stick, Class A, including CD		B	3ZS1 313-5CC10-0YA5	1	1 unit 131
	Soft Starter ES 2007 Premium Floating license for one user E-SW, software and documentation on CD, 3 languages (German/English/French), communication through system interface or PROFIBUS • License key on USB stick, Class A, including CD		B	3ZS1 313-6CC10-0YA5	1	1 unit 131
SIRIUS 3RW44 Soft Starter Function Block Library for SIMATIC PCS 7¹⁾						
	Scope of supply: AS modules and faceplates for integrating SIRIUS 3RW44 into the PCS 7 process control system, for PCS 7, version V 6.1/V 7.0					
	Engineering software for one engineering station (single license) including run- time software for execution of the AS module in an automation system (single license), German/English/French, Type of delivery: on CD incl. electronic documentation in German/English/Portuguese		▶	3ZS1 633-1XX00-0YA0	1	1 unit 131
	Runtime software for execution of the AS module in an automation system (single license), Type of delivery: License without software and documentation		▶	3ZS1 633-2XX00-0YB0	1	1 unit 131

¹⁾ For detailed information about the Soft Starter ES software program and about the SIRIUS 3RW44 Soft Starter Function Block Library for SIMATIC PCS 7 see Chapter 12 "Planning, Configuration and Visualizing for SIRIUS".

SIRIUS 3RW Soft Starters

3RW44 for High-Feature Applications



3RW44

Version	DT	Order No.	Price per PU	PU (UNIT, SET, M)	PS*	PG
PC cables						
		For PC/PG communication with SIRIUS 3RW44 soft starters				
	A	3UF7 940-0AA00-0		1	1 unit	131
		Through the system interface, for connecting to the serial interface of the PC/PG				
3UF7 940-0AA00-0						
USB/serial adapters						
		For connecting the PC cable to the USB interface of a PC				
	B	3UF7 946-0AA00-0		1	1 unit	131
		We recommend, in conjunction with 3RW44 soft starter, using SIMOCODE pro 3UF7, 3RK3 modular safety system, ET 200S/ECOFAS/ET 200pro motor starters, AS-i safety monitor, AS-i analyzer				
PROFIBUS communication modules						
		Modules can be plugged into the soft starters for integrating the starters in the PROFIBUS network with DPV1 slave functionality. On Y-link the soft starter has only DPV0 slave functionality.				
	A	3RW49 00-0KC00		1	1 unit	131
3RW49 00-0KC00						
External display and operator modules						
		For indicating and operating the functions provided by the soft starter using an externally mounted display and operator module in degree of protection IP54 (e. g. in the control cabinet door)				
		3RW49 00-0AC00		1	1 unit	131
3RW49 00-0AC00						
		Connection cable				
		From the device interface (serial) of the 3RW44 soft starter to the external display and operator module				
	A	3UF7 932-0AA00-0		1	1 unit	131
	A	3UF7 932-0BA00-0		1	1 unit	131
	A	3UF7 937-0BA00-0		1	1 unit	131
	A	3UF7 933-0BA00-0		1	1 unit	131
		• Length 0.5 m, flat				
		• Length 0.5 m, round				
		• Length 1.0 m, round				
		• Length 2.5 m, round				

SIRIUS 3RW Soft Starters

3RW44 for High-Feature Applications

3RW44

	For soft starters	Version	DT	Order No.	Price per PU	PU (UNIT, SET, M)	PS*	PG
Box terminal blocks for soft starters								
 3RT19	Box terminal blocks (2 units are required for each device)							
	3RW44 2.	Included in the scope of supply						
	3RW44 3.	<ul style="list-style-type: none"> Up to 70 mm² Up to 120 mm² 	▶	3RT19 55-4G		1	1 unit	101
		Auxiliary conductor connection for box terminals	B	▶	3RT19 56-4G		1	1 unit
	3RW44 4.	<ul style="list-style-type: none"> Up to 240 mm² (with auxiliary conductor connection) 	▶	3RT19 66-4G		1	1 unit	101
Covers for soft starters								
Terminal covers for box terminals								
Additional touch protection to be fitted at the box terminals (2 units required per device)								
	3RW44 2. and 3RW44 3.		▶	3RT19 56-4EA2		1	1 unit	101
	3RW44 4.		▶	3RT19 66-4EA2		1	1 unit	101
 3RT19.6-4EA1	Terminal covers for cable lugs and busbar connections							
	3RW44 2. and 3RW44 3.	For complying with the phase clearances and as touch protection (2 units required per contactor)	▶	3RT19 56-4EA1		1	1 unit	101
	3RW44 4.	Also fits on mounted box terminals.	▶	3RT19 66-4EA1		1	1 unit	101
Manuals 3RW44¹⁾								
	3RW44			3ZX10 12-0RW44-1AB1				
Operating instructions¹⁾								
	3RW44			3ZX10 12-0RW44-0AA0				

¹⁾ The operating instructions are included in the scope of supply of the soft starter or are available – like the manual – as a PDF download from the Service&Support portal at www.siemens.com/industrial-controls/support --> Controls --> Soft Starters and Solid-State Switching Devices --> SIRIUS 3RW Soft Starters.

Spare parts

	For soft starters	Version	DT	Order No.	Price per PU	PU (UNIT, SET, M)	PS*	PG
Fans								
 3RW49	Fans							
	3RW44 2. and 3RW44 3.	115 V AC	▶	3RW49 36-8VX30		1	1 unit	131
		230 V AC	▶	3RW49 36-8VX40		1	1 unit	131
	3RW44 4.	115 V AC	▶	3RW49 47-8VX30		1	1 unit	131
		230 V AC	▶	3RW49 47-8VX40		1	1 unit	131
	3RW44 5. and 3RW44 6. ¹⁾	115 V AC	▶	3RW49 57-8VX30		1	1 unit	131
		230 V AC	▶	3RW49 57-8VX40		1	1 unit	131
	3RW44 6. ²⁾	115 V AC	▶	3RW49 66-8VX30		1	1 unit	131
	230 V AC	▶	3RW49 66-8VX40		1	1 unit	131	

¹⁾ 3RW44 6. mounting on output side.

²⁾ For mounting on front side.

SIRIUS 3RW Soft Starters

3RW44 for High-Feature Applications

3RW44

More information

Application examples for normal starting (CLASS 10)

Normal starting CLASS 10 (up to 20 s with 350 % $I_{n \text{ motor}}$)

The soft starter rating can be selected to be as high as the rating of the motor used

Application		Conveyor belt	Roller conveyor	Compressor	Small fan ¹⁾	Pump	Hydraulic pump
Starting parameters							
• Voltage ramp and current limiting							
- Starting voltage	%	70	60	50	30	30	30
- Starting time	s	10	10	10	10	10	10
- Current limit value		Deactivated	Deactivated	$4 \times I_M$	$4 \times I_M$	Deactivated	Deactivated
• Torque ramp							
- Starting torque		60	50	40	20	10	10
- End torque		150	150	150	150	150	150
- Starting time		10	10	10	10	10	10
• Breakaway pulse							
		Deactivated (0 ms)	Deactivated (0 ms)	Deactivated (0 ms)	Deactivated (0 ms)	Deactivated (0 ms)	Deactivated (0 ms)
Ramp-down mode							
		Smooth ramp-down	Smooth ramp-down	Free ramp-down	Free ramp-down	Pump ramp-down	Free ramp-down

Application examples for heavy starting (CLASS 20)

Heavy starting CLASS 20 (up to 40 s with 350 % $I_{n \text{ motor}}$)

The soft starter has to be selected one performance class higher than the motor used

Application		Stirrer	Centrifuge	Milling machines
Starting parameters				
• Voltage ramp and current limiting				
- Starting voltage	%	30	30	30
- Starting time	s	30	30	30
- Current limit value		$4 \times I_M$	$4 \times I_M$	$4 \times I_M$
• Torque ramp				
- Starting torque		30	30	30
- End torque		150	150	150
- Starting time		30	30	30
• Breakaway pulse				
		Deactivated (0 ms)	Deactivated (0 ms)	Deactivated (0 ms)
Ramp-down mode				
		Free ramp-down	Free ramp-down	Free ramp-down or DC braking

Application examples for very heavy starting (CLASS 30)

Very heavy starting CLASS 30 (up to 60 s with 350 % $I_{n \text{ motor}}$)

The soft starter has to be selected two performance classes higher than the motor used

Application		Large fans ²⁾	Mills	Breakers	Circular saws/bandsaws
Starting parameters					
• Voltage ramp and current limiting					
- Starting voltage	%	30	50	50	30
- Starting time	s	60	60	60	60
- Current limit value		$4 \times I_M$	$4 \times I_M$	$4 \times I_M$	$4 \times I_M$
• Torque ramp					
- Starting torque		20	50	50	20
- End torque		150	150	150	150
- Starting time		60	60	60	60
• Breakaway pulse					
		Deactivated (0 ms)	80 %; 300 ms	80 %; 300 ms	Deactivated (0 ms)
Ramp-down mode					
		Free ramp-down	Free ramp-down	Free ramp-down	Free ramp-down

¹⁾ The mass inertia of the fan is <10 times the mass inertia of the motor.

²⁾ The mass inertia of the fan is ≥10 times the mass inertia of the motor.

Note:

These tables present sample set values and device sizes. They are intended only for the purposes of information and are not binding. The set values depend on the application in question and must be optimized during commissioning. The soft starter dimensions should be checked where necessary with the Win-Soft Starter software or with the help of Technical Assistance.

SIRIUS 3RW Soft Starters

3RW44 for High-Feature Applications

3RW44

Circuit concept

The SIRIUS 3RW44 soft starters can be operated in two different types of circuit.

- **Inline circuit**
The controls for isolating and protecting the motor are simply connected in series with the soft starter. The motor is connected to the soft starter with three cables.
- **Inside-delta circuit**
The wiring is similar to that of wye-delta starters. The phases of the soft starter are connected in series with the individual motor windings. The soft starter then only has to carry the phase current, amounting to about 58 % of the rated motor current (conductor current).

Comparison of the types of circuit

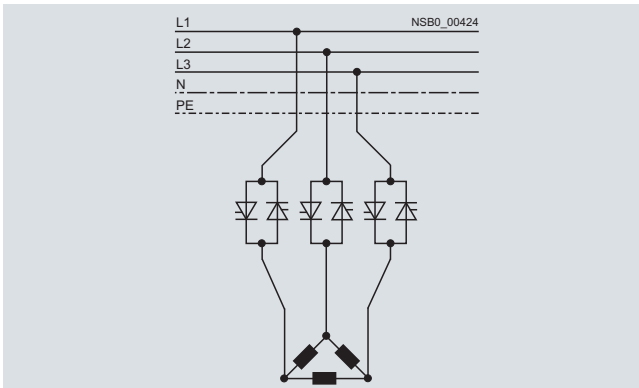

Inline circuit:

Rated current I_g corresponds to the rated motor current I_n , 3 cables to the motor

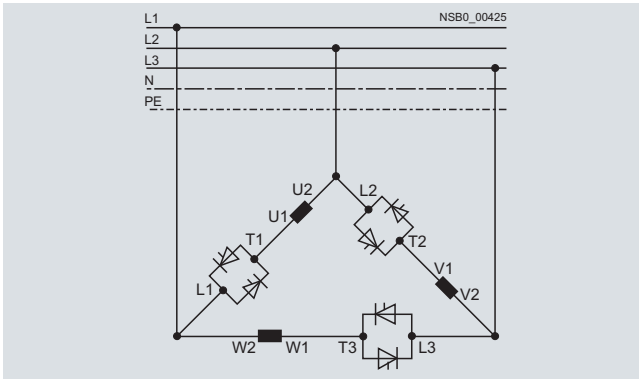

Inside-delta circuit:

Rated current I_g corresponds to approx. 58 % of the rated motor current I_n , 6 cables to the motor (as with wye-delta starters)

Which circuit?

Using the inline circuit involves the lowest wiring outlay. If the soft starter to motor connections are long, this circuit is preferable. With the inside-delta circuit there is double the wiring complexity but a smaller size of device can be used at the same rating.

Thanks to the choice of operating mode between the inline circuit and inside-delta circuit, it is always possible to select the most favorable solution.

The braking function is possible only in the inline circuit.

Configuration

The 3RW44 solid-state soft starters are designed for normal starting. In case of heavy starting or increased starting frequency, a larger device must be selected.

For long starting times it is recommended to have a PTC sensor in the motor. This also applies for the ramp-down modes smooth ramp-down, pump ramp-down and DC braking, because during the ramp-down time in these modes, an additional current loading applies in contrast to free ramp-down.

No capacitive elements are permitted in the motor feeder between the SIRIUS 3RW soft starter and the motor (e. g. no reactive-power compensation equipment). In addition, neither static systems for reactive-power compensation nor dynamic PFC (Power Factor Correction) must be operated in parallel during starting and ramp-down of the soft starter. This is important to prevent faults arising on the compensation equipment and/or the soft starter.

All elements of the main circuit (such as fuses and controls) should be dimensioned for direct starting, following the local short-circuit conditions. Fuses, controls and overload relays must be ordered separately.

A bypass contact system and solid-state overload relay are already integrated in the 3RW44 soft starter and therefore do not have to be ordered separately.

The harmonic component load for starting currents must be taken into consideration for the selection of motor starter protectors (selection of release).

Note:

When induction motors are switched on, voltage drops occur as a rule on starters of all types (direct starters, wye-delta starters, soft starters). The infeed transformer must always be dimensioned such that the voltage dip when starting the motor remains within the permissible tolerance. If the infeed transformer is dimensioned with only a small margin, it is best for the control voltage to be supplied from a separate circuit (independently of the main voltage) in order to avoid the potential switching off of the soft starter.

Device interface, PROFIBUS DP communication module, Soft Starter ES parameterizing and operating software

The 3RW44 electronic soft starters have a PC interface for communicating with the Soft Starter ES software or for connecting the external display and operator module. If the optional PROFIBUS communication module is used, the 3RW44 soft starter can be integrated in the PROFIBUS network and communicate using the GSD file or Soft Starter ES Premium software.

SIRIUS 3RW44 Soft Starter Function Block Library for SIMATIC PCS 7

The SIRIUS 3RW44 soft starter PCS 7 function block library can be used for simple and easy integration of SIRIUS 3RW44 soft starters into the SIMATIC PCS 7 process control system. The SIRIUS 3RW44 soft starter PCS 7 function block library contains the diagnostics and driver blocks corresponding with the SIMATIC PCS 7 diagnostics and driver concept as well as the elements (symbols and faceplates) required for operator control and process monitoring.

SIRIUS 3RW Soft Starters

3RW44 for High-Feature Applications

3RW44

Manual for SIRIUS 3RW44

Besides containing all important information on configuring, commissioning and servicing, the manual also contains example circuits and the technical specifications for all devices.

Win-Soft Starter selection and simulation program

With this software, you can simulate and select all Siemens soft starters, taking into account various parameters such as mains properties, motor and load data, and special application requirements.

The software is a valuable tool, which makes complicated, lengthy manual calculations for determining the required soft starters superfluous.

The Win-Soft Starter selection and simulation program can be downloaded from:

www.siemens.com/softstarter --> Software

You can find more information about soft starters on the Internet likewise at:

www.siemens.com/softstarter

Training course for SIRIUS soft starters (SD-SIRIUSO)

Siemens offers a 2-day training course on the SIRIUS solid-state soft starters to keep customers and own personnel up-to-date on configuring, commissioning and maintenance issues.

You can find more information on our SITRAIN website:

www.siemens.com/sitrain

--> For course name select "SD-SIRIUSO"

Please direct enquiries and applications to SITRAIN Customer Support:

Tel.: +49 (1805) 23 56 11

Fax: +49 (1805) 23 56 12

E-mail: info@sitrain.com