

# ADAM-4521

## Addressable RS-485 to RS-232 Converter with 1000 V<sub>DC</sub> Isolation

### Introduction

ADAM-4521 is an intelligent RS-485 to RS-232 converter specifically designed to connect RS-232 devices to an RS-485 network with other RS-485 devices. RS-232 is the most common transmission standard. Although widely available on most computer systems, measurement equipment, PLCs, and industrial devices, its transmission speed, communication distance, and especially networking capability are limited due to unbalanced transmission. The ADAM-4521 addressable converter solves this problem and lets you easily build up an RS-485 network with your RS-232 devices by assigning each one an address for easier communication.

### Built-in Intelligence

ADAM-4521 is equipped with a built-in microprocessor, which uses two UARTs and automatically processes data before transmitting it to the RS-232 device. This makes ADAM-4521 able to allow different baud rates between RS-232 devices and the RS-485 network. The microprocessor also verifies whether the data is transmitted with the appropriate address, which enables each device on the RS-485 network to communicate with your PC over long distances.

### RS-485 Network with Automatic Data Flow Control

The RS-485 standard supports half-duplex communication, meaning a single pair of wires is used to both transmit and receive data. Handshaking signals such as RTS (Request To Send) are normally used to control the direction of the data flow, but a special I/O circuit in the ADAM-4521 automatically senses the direction of the data flow and switches the transmission direction. No handshaking signals are necessary.

### Features

- Built-in microprocessor
- Transmission speeds of up to 115.2 kbps
- 1000 V<sub>DC</sub> isolation
- Surge protection on RS-485 line
- RS-232 and RS-485 can be set to different baud rates
- Automatic RS-485 data flow control
- Watchdog timer function included
- Power and data flow indicator for troubleshooting
- Reserved space for termination resistor
- Software configurable to either addressable or non-addressable mode
- Easily mounted on DIN rail, panel or piggyback
- All communication setups stored in EEPROM

### Specifications

- **Transmission speed (bps):** 300, 600, 1200, 2400, 4800, 9600, 19.2K, 38.4K, 57.6K, 115.2K (software configurable)
- **Power requirement:** Unregulated +10 to +30 V<sub>DC</sub> with protection from power reversals
- **Case:** ABS with captive mounting hardware
- **Accessories (included):** Nylon DIN-rail mounting adapter, SECC panel mounting bracket
- **RS-232 interface connector:** Female DB-9
- **RS-422/RS-485 interface connector:** plug-in screw terminal (accepts AWG 1-#12 or 2-#14-#22 (0.5 to 2.5mm<sup>2</sup>) wires)
- **Operating temperature:** -10 to 70°C
- **Dimension:** 2.36" x 4.41" (60mm x 120mm)
- **Power consumption:** 1 W

## Installation

### Initial Inspection

We carefully inspect the ADAM-4521 both mechanically and electrically before we ship it. It should be free of marks and scratches and in perfect order on receipt.

As you unpack the module, check it for signs of shipping damage (damaged box, scratches, dents, etc.). If it is damaged or fails to meet our specifications, notify our service department or your local sales representative immediately. Also, call the carrier immediately and retain the shipping carton and packing material for inspection by the carrier. We will then make arrangements to repair or replace the unit.

Before you begin installation, please make sure you have the following items:

- 1 ADAM-4521 module
- 1 Bracket
- 1 Utility disk

### Basic Configuration

Before installing the ADAM-4521 in an existing network, it should be configured. Though all modules are initially configured at the factory, it is recommended that you check the baud rate settings.

#### Factory Default Settings:

Protocol: RS-485  
Baud Rate: 9600 bps  
Delimiter: {  
Mode: Addressable  
Add cr: Yes  
Address: 01

## Power Supply

For the ease of use in industrial environments the ADAM modules are designed to accept industry standard  $+24 V_{DC}$  unregulated power. Operation is guaranteed when using any power supply between  $+10$  and  $+30 V_{DC}$ . Power ripples must be limited to 5V peak to peak while the voltage in all cases must be maintained between  $+10$  and  $+30 V_{DC}$ . All power supply specifications are referenced at module connector.

The power cables should be selected according to the number of modules connected and the length of the power lines. When using a network with long cables, we advise the use of thicker wire to limit the line voltage drop. In addition to serious voltage drops, long voltage lines can also cause interference with communication wires.

We advise that the following standard colors (as indicated on the modules) be used for power lines:

$+V_s$  → (R) Red  
GND → (B) Black

### Communication Wiring

We recommend that shielded-twisted-pair cables that comply with the EIA RS-485 standard be used with the ADAM network to reduce interference. Only one set of twisted-pair cables is required to transmit both Data and RTS signals. We advise that the following standard colors (as indicated on the modules) be used for the communication lines:

DATA + (Y) → Yellow  
DATA - (G) → Green

## Basic Connection Diagram

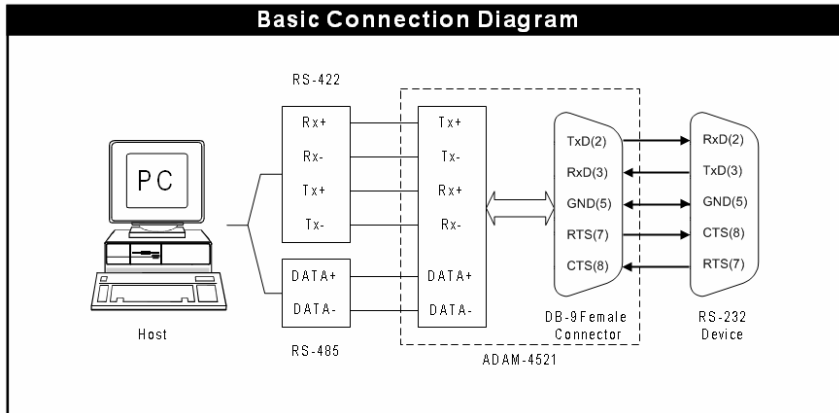

## Software Configuration

The ADAM-4521 comes with a utility disk containing software with the following capabilities:

- Baud rate configuration
- Address configuration
- Addressable or non-addressable mode selection
- RS-485 or RS-422 mode selection

**NOTE:** Before configuring the ADAM-4521, make sure it is connected to your host through an RS-422 or RS-485 line.

The main screen consists of a menu bar at the top and a status field which displays information about the connected modules. When you first start the program, it will automatically scan for any connected modules and display their data. The status field lists module characteristics and configuration parameters.

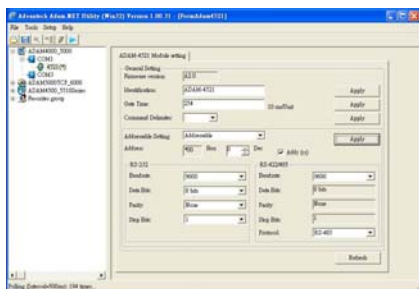

Figure 1 Main Screen

**NOTE:** An asterisk sign "\*" after the module's address indicates that the module is in the INIT\* state.

## COMport

To configure your communication port, press COMport icon. A menu will appear allowing you to change which port you are using, the baud rate, and the timeout.

## Search

To scan the network for connected devices, click the right button on the COM port to search the existed com port. A window will appear and prompt you for a value from 0 to 255. It will then scan all the addresses from 0 to that number.

## Setup

When you enter the setup screen, look at the below frame of screen. You can see the RS-232 setting and the RS-485 setting. Please check the setting of the interface. You can choose a proper item to fit your owned setting. After you finish the setting, please remember to press the Apply button on the right side.

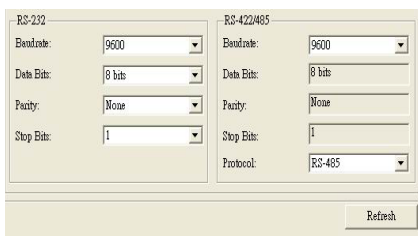

Figure 2 Setup Options

1. To change the basic settings, select the item the press <Enter>. Choose the parameter you wish to change, and press <Enter>. A small popup window will appear with the configuration options for that parameter. Choose the proper value, and press <Enter>.
2. To change the RS-232/RS-485(RS-422) baud rate settings, select RS-232 Frame or RS-422/485 Frame and press <Enter>. Choose the parameter you wish to change and press <Enter>. A window will appear with the configuration options for that parameter. Choose the proper value and press <Enter>. In addition, you can assign the module with proper ID via the Identification option.
3. The Mode (addressable or non-addressable) and Baud Rate options need special attention because they can only be changed when ADAM-4521 is in the INIT\* state. To alter the Mode and Baud Rate, do the following:

- Power all components on except ADAM-4521.
- Power ADAM-4521 on while shorting the INIT\* and GND terminals.
- Configure the Mode and/or Baud Rate.
- Power ADAM-4521 off.
- Remove the grounding of the INIT\* terminal, and power ADAM-4521 on.
- Check the settings.

### INIT\* state default settings:

Baud Rate: 9600 bps  
Protocol: RS-485  
Address: 00h

- After you have made the changes for a block of parameters, press <Apply>. You will be asked if you are satisfied with the changes you have made or not. Press "Yes" to keep the changes you have made, "No" to escape without changing the values.

**NOTE:** *When changing configuration parameters, always make sure a window appears notifying you that the target module has confirmed the changes.*

## Terminal

This selection allows you to directly send and receive commands on the RS-485 line. It has two options: Advantech ASCII and Modbus Screen.

Choosing Advantech ASCII will place the ADAM-4521 in command test mode, where you send commands one at a time by typing them into the top blank and pressing <Send>. The response appears in the bottom blank. To send the command again, simply press <Send>.

Modbus mode is a Modbus type of command test. Previous commands and their responses stay on the screen for you to refer to. If you want to repeatedly send a command, press <Start> and you can choose the Modbus type to fit your setting. There are Coil Status, Input Status, Holding Register, Input Register.

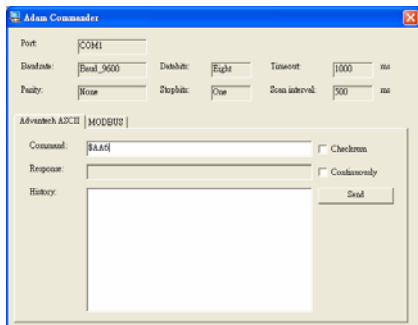

**Figure 3 Command Test**

A box on the right hand side of the screen shows the communication parameters for the serial line such as the baud rate and number of stop bits.

## Quit

Choosing File on the menu bar, then choose the Exit button to ends the ADAM utility program.

## Command Set

To avoid communication conflicts when several devices try to send data at the same time, all actions are instigated by the host computer. The basic form is a command/response protocol with the host initiating the sequence.

When modules are not transmitting, they are in listen mode. The host issues a command to a module with a specified address and waits a certain amount of time for the module to respond. If no response arrives, a timeout aborts the sequence and returns control to the host.

## Syntax

[delimiter character] [address] [command] [data]  
[checksum] [carriage return]

Every command begins with a delimiter character. The first four commands can use a dollar sign \$ or a percentage sign %, but the Data Pass command uses one of eight special characters, as described on the following page.

The delimiter character is followed by a two-character address (hexadecimal) that specifies the target module. The actual two character command follows the address. Depending on the command, an optional data segment follows the command string. An optional two character checksum may be appended to the total string. Every command is terminated by a carriage return (cr).

**NOTE:** *ALL COMMANDS SHOULD BE ISSUED IN UPPERCASE CHARACTERS.*

Command Syntax	Command Name	Description
\$AA6(ID)	Set ID	Assign an ID of up to 24 bytes to the module at address AA.
\$AA7	Read ID	Read the ID from the module at address AA.
\$AAC(delimiter)	Set Delimiter	Set the delimiter character for the Data Pass command.
\$AAD	Read Delimiter	Read the delimiter character from the module at address AA.
Delimiter AA(data)	Data Pass	Tell the module at address AA to pass up to 32 bytes of data to the RS-232 device.

## Command Descriptions

### Set ID

**Description** Assign an ID of up to 24 bytes to the module at address AA.

**Syntax** \$AA6(identification) (cr)

**Response** !AA (cr) if the command is valid.

**Example** command: \$246ADAM NETWORK 1 (cr)  
response: !24 (cr)

The command asks the module at address 24h to write "ADAM NETWORK 1" to EEPROM.

### Read ID

**Description** Read the ID from the module at address AA.

**Syntax** \$AA7 (cr)

**Response** !AA(identification) (cr)

**Example** command: \$247 (cr)  
response: !24ADAM NETWORK 1 (cr)

The command asks the module at address 24h to return the identification data from EEPROM.

### Set Delimiter

**Description** set the delimiter character for the Data Pass command. There are 8 special characters to choose from:

: [ ] ^ { | } ~

**Syntax** \$AAC(delimiter) (cr)

**Response** !AA (cr) if the command is valid

**Example** command: \$24C{ (cr)  
response: !24 (cr)

The command asks the module at address 24h to write delimiter character { to EEPROM.

### Read Delimiter

**Description** Read the delimiter character from the module at address AA.

**Syntax** \$AAD (cr)

**Response** !AA(delimiter) (cr) if the command is valid. (delimiter) is a character for the Data Pass command.

**Example** command: \$24D (cr)  
response: !24{ (cr)

The command asks the module at address 24h to return the delimiter character from EEPROM.

### Data Pass

**Description** Tell the module at address AA to pass up to 32 bytes of data to the RS-232 device.

**Syntax** (delimiter)AA(data) (cr)

**Response** depends on the device

**Example** command: !24#02 (cr)  
response:

The command asks the module at address 24h to send #02 (cr) to the RS-232 communication port.

## Example Program

This demo program demonstrates how you might send a string of data to your HP34401A Multimeter (RS-232 device) via the ADAM-4521.

### ADAM-4521 Configuration Status:

```
ADDRESS:02
MODE:ADDRESSABLE
DELIMITER: {
ADD(CR):NO
RS-485 baud(9600),N,8,1
RS-232 baud(9600),N,8,2
HP34401A RS-232 baud(9600),N,8,2
```

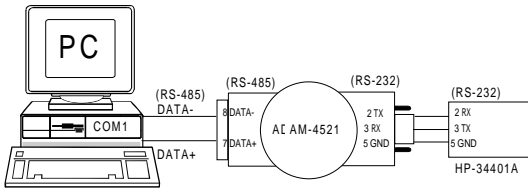

### Program: DEMO01.C

```
#include <dos.h>
#include <io.h>
#include <stdio.h>
#include <conio.h>
#define TIME_OUT 500000
static int base0=0x3F8;
static char rec[36];
static char cmd[40];

void send(void);
void receive(void);

void main()
{
    outp(base0+3,0x80); /* set DLAB=1 */
    outp(base0 ,0x0C); outp(base0+1,0x00); /* set baud=9600 */
    outp(base0+3,0x03); /* set data=8 stop=1 no parity */
    outp(base0+1,0x00); /* disable COM1 interrupt */
    printf("\nInput string : ");
    gets(cmd);
    while (cmd[0] != 'q' && cmd[0] != 'Q')
    {
        send();
        receive();
        printf("\nInput string : ");
        gets(cmd);
    }
}
```

```

void send()
{
    static int i,flag;
    i=strlen(cmd);
    cmd[i]=0x0a; /* HP-34401A uses LF(0x0a) as the end of an incoming command. */
    cmd[i+1]=0x0d;
    i=0;
    flag=1;
    while (flag)
    {
        outportb(base0,cmd[i]); /* Send data */
        while((inportb(base0+5)& 0x40)!=0x40);
        if(cmd[i] == 0x0d)
            flag=0;
        i++;
    }
    while( (inportb(base0+5)&0x40) !=0x40);
}

void receive(void)
{
    int i,flag;
    long int timeout;
    i=0;
    flag=1;
    timeout=TIME_OUT;
    while (flag)
    { /* Check receiver data */
        if ((inportb(base0+5) & 1) !=0)
        {
            rec[i]=inportb(base0); /* Receive data */
            if(rec[i] == 0x0a)/* HP34401A uses 0x0a as the end of an outgoing command. */
                rec[i+1]='\0';
            flag=0;
            printf("\nReceived data : %s",rec);
        }
        i++;
    }
    else
    { /* Check timeout */
        timeout--;
        if (timeout == 0)
        {
            flag = 0;
            printf("\nTimeout error\n");
        }
    }
}
}
}

```

## Output

---

```

Input string:  {02:SYST:REM           (Put the multimeter into remote operation mode.)
Timeout error
Input string:  {02*IDN?              (Read the multimeter ID.)
Received data: HEWLETT-PACKARD,34401A,0,3-1-1
Input string:  {02:SYST:VERS?       (Ask what version of SCPI the multimeter conforms to.)
Received data: 1991.0
Input string:  {02:READ?            (Trigger the readings, and read the results.)
Received data: +6.91849000E-04

```

# ADAM-4521 Dimensions

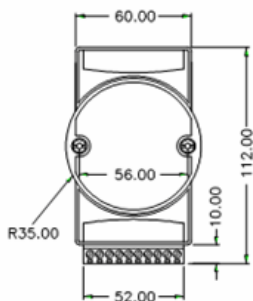

FRONT VIEW

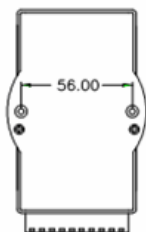

REAR VIEW

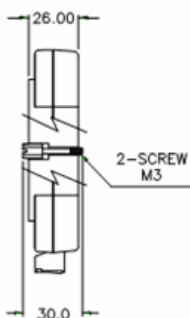

SIDE VIEW

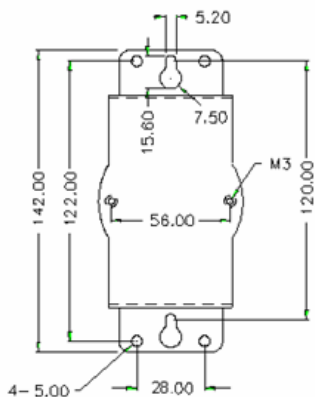

PANEL MOUNTING  
BRACKET

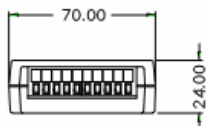

TOP VIEW

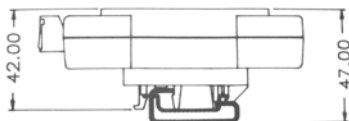

DIN-RAIL MOUNTING  
ADAPTER