

**DIGITAL TEMPERATURE
RELAY
TR-100M**



OPERATING MANUAL

*The quality management system of production complies with the requirements of
ISO 9001:2008*

Dear customer,

Company NOVATEK-ELECTRO LTD. thanks you for purchasing our products.
You will be able to use properly the product after carefully studying the Operating Manual.
Keep the Operating Manual throughout the service life of the product.

CONTENT

1 APPLICATION	4
1.1 Product application	4
1.2 Controls, overall and mounting dimensions	4
1.2.1 Overall and mounting dimensions of TP-100M	4
1.2.2 Indication and controls	4
1.3 Operation conditions	5
2 COMPONENTS	5
3 SPECIFICATIONS	5
3.1 Basic Specifications	5
3.2 Programmable and used parameters	6
4 DESCRIPTION AND OPERATION OF THE PRODUCT	8
4.1 Design	8
4.2 Principle of operation	8
5 INTENDED USE	8
5.1 Preparation for operation	8
5.1.1 Preparation for connection	8
5.1.2 General instructions	9
5.1.3 Product installation	9
5.1.4 Product connection	10
5.2 Use of the product	11
5.2.1 Product control	11
5.2.2 Display of parameters	11
5.2.3 Changing of parameters	11
5.2.4 Adjustment of cooling parameters	12
5.2.5 Display of maximum attained temperature	12
5.2.6 Restoring of factory default settings	12
5.2.7 Testing of output load relays	12
5.2.8 Testing of indication	12
5.3 Description of alarm status	12
5.4 Temperature transducers	13
5.4.1 Transducer of PT100 type	13
5.4.2 Transducer of PT1000 type	13
5.4.3 Transducer of PTC1000 (EKS111) type	13
5.4.4 Transducer of PTC (minika) type	13
5.5 Digital filtering of temperature	14
5.6 Remote control of output relays	14
5.7 Operation with EIA/TIA-485 MODBUS interface	14
5.7.1 General	14
5.7.2 Message formats	15
5.7.2.1 Byte format	15
5.7.2.2 Frame format	16
5.7.3 Generation and verification of check sum	16
5.7.3.1 Generation of check sum of CRC	16
5.7.3.2 Generation of check sum of LRC	17
5.7.4 Command system	17
5.7.4.1 Function 0x03 – Reading of register group	17
5.7.4.2 Function 0x06 – Recording of the register	17
5.7.4.3 Function 0x08 – Diagnostics	17
6 MAINTENANCE	18
7 SERVICE LIFE AND MANUFACTURER WARRANTY	19
8 TRANSPORTATION AND STORAGE	19
9 ACCEPTANCE CERTIFICATE	19
10 CLAIMS DATA	19

ATTENTION! ALL REQUIREMENTS OF THIS OPERATION MANUAL ARE COMPULSORY TO BE MET!



WARNING! – PRODUCT TERMINALS AND INTERNAL COMPONENTS ARE UNDER POTENTIALLY LETHAL VOLTAGE

TO ENSURE THE PRODUCT SAFE OPERATION IT IS STRICTLY FORBIDDEN THE FOLLOWING:

– TO CARRY OUT MOUNTING WORKS AND MAINTENANCE WITHOUT DISCONNECTING THE PRODUCT FROM THE MAINS:

- TO OPEN AND REPAIR THE PRODUCT INDEPENDENTLY;

– TO OPERATE THE PRODUCT WITH MECHANICAL DAMAGES OF THE CASE.

IT IS NOT ALLOWED WATER PENETRATION ON TERMINALS AND INTERNAL ELEMENTS OF THE PRODUCT.

**During operation and maintenance the regulatory document requirements must be met, namely:
Regulations for Operation of Consumer Electrical Installations;
Safety Rules for Operation of Consumer Electrical Installations;
Occupational Safety when in Operation of Electrical Installations;**

Installation, adjustment and maintenance of the product must be performed by qualified personnel having studied this Operation Manual.

The product is safe for use under keeping of the operating rules.

This Operation Manual is intended to familiarize you with arrangement, the requirements for safety, operation and maintenance procedures of the digital temperature relay of TR-100M type (hereinafter referred to as the "product", "TR-100M").

The product meets the requirements of the following:

- Low-voltage switchgear; Part 1; General rules (IEC 60947-1:2004, IDT);
- Low-voltage circuit breaker and controller; Part 6-2; multifunctional equipment; Control and safety switching equipment (IEC 60947-6-2:1992, IDT);
- Electromagnetic compatibility; Industrial, scientific and medical RF equipment; electromagnetic interference characteristics; standards and measuring procedure (CISPR 11:2004, IDT);
- Electromagnetic compatibility; Part 4-2; Testing and measurement techniques; Electrostatic discharge immunity test (IEC 61000-4-2:2001, IDT).

Harmful substances in amounts exceeding maximum permissible concentrations are not available.

1 APPLICATION

1.1 Product application

TR-100M is the microprocessor-based device intended to measure and control temperature mode of dry-type transformer with four transducers connected by two- or three-wire circuit, with subsequently displaying the temperature on the display and sending alarms when any parameters are outside preset limits.

The product can also be used for protection of motors and generators.

The product has the **universal** power supply of 24 to 265 V (AC or DC) and connection to network IIA/TIA-485 with MODBUS RTU / ASCII protocol.

The product can be applied with the following types of temperature transducers:

- PT100 – platinum transducer with rated resistance of 100 Ohm, at 0°C;
- PT1000 – platinum transducer with rated resistance of 1000 Ohm, at 0°C;
- PTC1000 (EKS111) – transducer with rated resistance of 990 Ohm, at 25°C;
- PTC (minika) – cold resistance of transducer of 20-250 Ohm.

1.2 Controls, overall and mounting dimensions

1.2.1 Overall and mounting dimensions of TR-100M

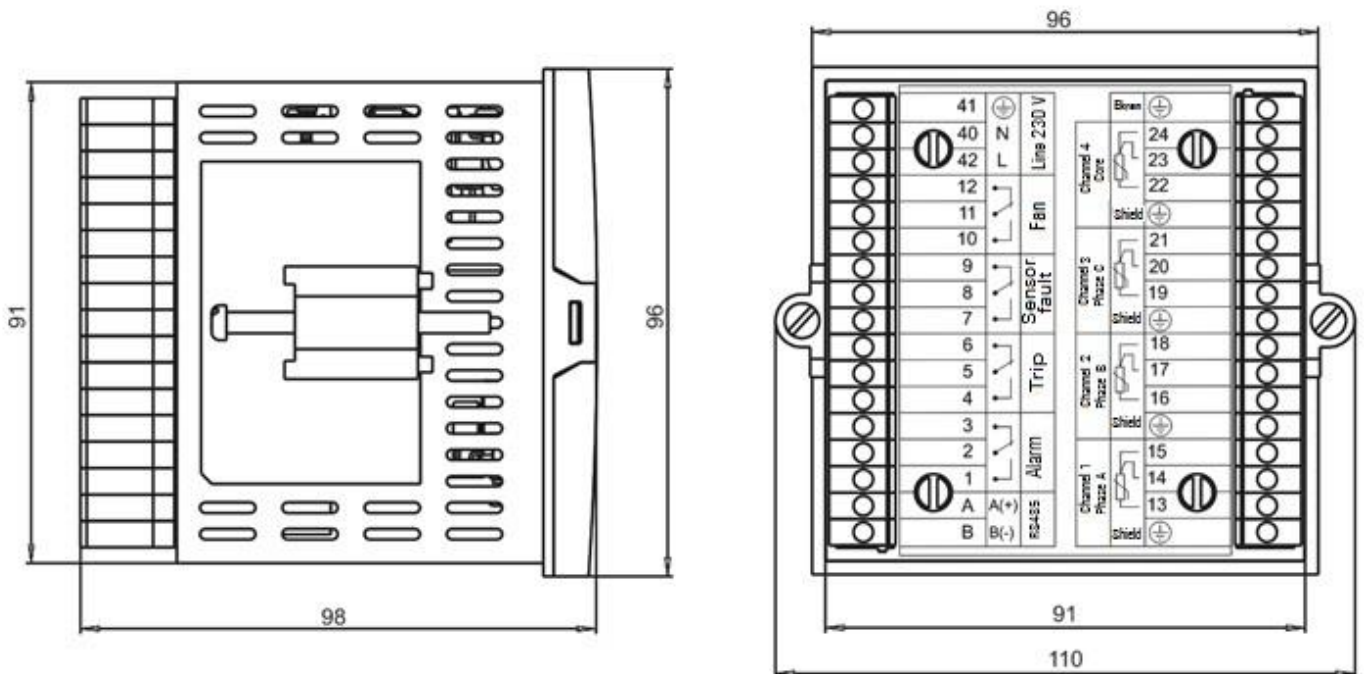
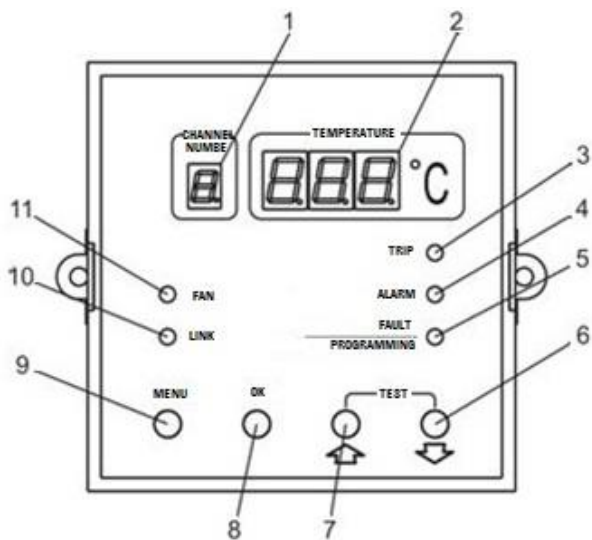

Figure 1.1 – Overall and mounting dimensions of TR-100M

1.2.2 Indication and controls

Figure 1.2 shows the appearance of the front panel of the product.



- 1 – Digital display for the number of operating display channel;
- 2 – Digital display for the temperature values;
- 3 – Indicator of **TRIP** relay enabling;
- 4 – Indicator of **ALARM** relay enabling;
- 5 – Indicator of TR-100M programming, **FAULT** and **PROGRAMMING** relay enabling;
- 6 – Button (DOWN);
- 7 – Button (UP);
- 8 – **OK** button (record and exit from parameters programming mode);
- 9 – **MENU** button (enter to review mode and parameters programming mode);
- 10 – Indicator of RS-485 communication activity;
- 11 – Indicator of cooling relay enabling.

Figure 1.2 – Front panel of TR-100M

1.3 Operation conditions

The product is designed for operation in the following conditions:

- Ambient temperature: from minus 35 to +50°C;
- Atmospheric pressure: from 84 to 106.7 kPa;
- Relative air humidity (at temperature of +25°C): 30 ... 80%.

ATTENTION! The product is not intended for operation in the following conditions:

- Significant vibration and shocks;
- High humidity;
- Aggressive environment with content in the air of acids, alkalis, etc., as well as severe contaminations (grease, oil, dust, etc.).

2 COMPONENTS

The product components are given in Table 2.1.

Table 2.1 – Product Components

Description	Quantity, pc
TR-100M	1
Fastener	2
Rubber seal	1
Removable terminal block	2
Operating Manual	1
Packing	1

3 SPECIFICATIONS

3.1 Basic Specifications

Basic Specifications of the product are given in Table 3.1.

Table 3.1 – Basic Specifications

Description	Value
Operating supply voltage (\sim), V	230 / 240
Voltage at which service capability is maintained (\sim / \dots), V	24 – 265
Frequency of supply mains, Hz	45 – 65
Consumed power (from mains of ~230 V), W, not more	6.0
Consumed power (from power supply unit +24 V), W, not more	2.2
Quantity of transducers connected, pc.	4
Types of transducers used to measure temperature	PT100, PT1000, PTC1000 (EKS111), PTC (minika)*
Transducers connection circuit	2 / 3-wire
Max. length of transducer wire depending on connection circuit, m	2-wire – to 5 m; 3-wire – to 100 m
Temperature measurement accuracy, °C	± 2

Table 3.1 (Continued)

Description	Value
Measured temperature range, °C: PT100 PT1000 PTC1000 (EKS111) PTC (minika)	minus 60 to +300 minus 60 to +300 minus 50 to +120 +60 to +180
Temperature digital filtering	Available
Quantity of output relays and contacts type, pc.	4 – switching
Commutation life of output contacts of the relay: – Electrical lifetime at 10A 250V AC (cos φ = 1.0), time, not less – Electrical lifetime at 10A 24V DC, time, not less – Mechanical lifetime, time, not less	100000 10000 10000000
Specification of output contacts of the relay: – Max. switching current at \sim 250 V (cos φ = 1.0), A – Max. switching current at \sim 250 V (cos φ = 0.4), A – Max. switching current at \dots 30 V, A – Max. switching power, VA	10 6 3 2500
Test of output relays	Available
Test of indication	Available
EIA/TIA-485 MODBUS RTU / ASCII	Available
Data storage time, year, not less	15
Product service	Control and distribution device
Rated operating condition	Continuous
Protection rating of front panel	IP64
Protection rating of housing	IP20
Electric shock protection class	II
Climatic version	NC 3.1
Permissible contamination level	II
Overvoltage category	II
Rated insulation voltage, V	450
Rated impulse withstand voltage, kV	2.5
Wire cross-section for connection to terminals, mm ²	0.5 – 2.5
Tightening torque of terminal screws, N*m	0.4
Weight, kg, not more	0.360
Overall dimensions (L x W x H), mm	110 x 98 x 96
Installation is designed on the front panel of the board (cabinet) or device	
The product remains functional at any position in space	

* – PTC (minika) transducers can be series-connected (by 1, 3, 6 pc.)	

3.2 Programmable and used parameters

Programmable and used parameters are given in Table 3.2.

Table 3.2 – Programmable and used parameters

Settings and readings	Parameter code	Min. / max. values	Factory setting	Parameter description	Address Dec
General					
Alarm	RLr	50/240°C	140	Temperature of ALARM relay enabling	100
Differential of alarm	dF.R	1/200°C	10	Differential of ALARM relay tripping	101
Overheat	trP	50/240°C	160	Temperature of TRIP relay enabling	102
Differential of overheat	dF.t	1/200°C	10	Differential of TRIP relay tripping	103
Cooling relay	FRn	0/3	1	Operating mode of FAN relay: 0 – it is always OFF; 1 – it is enabled by channels 1, 2 and 3; 2 – it is enabled by channels 1, 2, 3 and 4; 3 – it is enabled by channel 4.	104
Cooling enabling	FOn	30/240°C	90	Temperature of FAN relay enabling	105
Differential of cooling	dF.F	1/200°C	20	Differential of FAN relay tripping	106

Table 3.2 (Continued)

Settings and readings	Parameter code	Min. / max. values	Factory setting	Parameter description	Address Dec
Delay	dLR	0/ 300 s	4	Delayed enabling of all the relays in case of emergency trip owing to temperature	107
Transducer fault	Rct	0/2	0	Actions when transducer is fault: 0 – Indication with transducer FAULT relay enabling; 1 – it.0 + ALARM relay enabling; 2 – it.1 + FAN relay enabling.	108
MODBUS					
Enabling	rSR	0/2	0	RS-485 connection enabling (disabling): 0 – it is OFF; 1 – it is ON; 2 – it is ON (remote control of output load relays).	109
Identifier	rSn	1/247	1	Product number (network address)	110
Type	rSc	0/1	0	Protocol type: 0 – MODBUS RTU; 1 – MODBUS ASCII.	111
Rate	rSs	0/3	2	Data transfer rate: 0 – 2400 (bps); 1 – 4800 (bps); 2 – 9600 (bps); 3 – 19200 (bps).	112
Parity	rSP	0/3	1	Parity check and stopping bits: 0 – No: 1 stop bit; 1 – No: 2 stop bits; 2 – Yes: Even: 1 stop bit; 3 – Yes: Odd: 1 stop bit.	113
Timeout	rSL	0/999	0	Response delay (x200 µs): Unit of value is equal to 200 µs.	114
System					
Display mode	dSP	0/2	2	Operating mode of display: 0 – It displays the highest temperature with Channel No.; 1 – Operator views temperature manually; 2 – Sequentially with 4s interval, it displays temperature of channels enabling;	115
Relay testing	tSt	0/4	0	Output relays testing: 0 – All relays are to be tested; 1 – FAN relay is to be tested; 2 – transducer FAULT relay is to be tested; 3 – TRIP relay is to be tested; 4 – ALARM relay is to be tested	116
Password	PRs	000/999	123	000 – Password is OFF; NNN – is the value of the password.	117
Reset	rSt	0/1	0	Reset of all the settings to factory set values: 0 – do not reset; 1 – reset all settings to factory set values.	118
Version	uEr	*	10	Micro-program version	119
Channel 1					
Channel enabling	chl	0/1	1	Channel 1 enabling (disabling): 0 – channel is OFF; 1 – channel is ON.	120
Calibration	cRl	-10/10°C	0	Offset of scale to CA1 value relative to temperature measured by transducer;	121
Type	ctl	0/3	0	Type of transducer used: 0 – PT100 (100 Ohm / 0°C); 1 – PT1000 (1000 Ohm / 0°C); 2 – PTC1000 (990 Ohm / 25°C); 3 – PTC (minika).	122

Table 3.2 (Continued)

Settings and readings	Parameter code	Min. / max. values	Factory setting	Parameter description	Address Dec
Max. t of channel**	c n̄ 1	-99/999°C	-99	Max. attained temperature;	123
Channel 2					
Channel enabling	c h̄ 2	0/1	1	Channel 2 enabling (disabling): 0 – channel is OFF; 1 – channel is ON.	124
Calibration	c R̄ 2	-10/10°C	0	Offset of scale to CA2 value relative to temperature measured by transducer;	125
Type	c t̄ 2	0/3	0	Type of transducer used: 0 – PT100 (100 Ohm / 0°C); 1 – PT1000 (1000 Ohm / 0°C); 2 – PTC1000 (990 Ohm / 25°C); 3 – PTC (minika).	126
Max. t of channel**	c n̄ 2	-99/999°C	-99	Max. attained temperature;	127
Channel 3					
Channel enabling	c h̄ 3	0/1	1	Channel 3 enabling (disabling): 0 – channel is OFF; 1 – channel is ON.	128
Calibration	c R̄ 3	-10/10°C	0	Offset of scale to CA3 value relative to temperature measured by transducer;	129
Type	c t̄ 3	0/2	0	Type of transducer used: 0 – PT100 (100 Ohm / 0°C); 1 – PT1000 (1000 Ohm / 0°C); 2 – PTC1000 (990 Ohm / 25°C).	130
Max. t of channel**	c n̄ 3	-99/999°C	-99	Max. attained temperature;	131
Channel 4					
Channel enabling	c h̄ 4	0/1	0	Channel 4 enabling (disabling): 0 – channel is OFF; 1 – channel is ON.	132
Calibration	c R̄ 4	-10/10°C	0	Offset of scale to CA4 value relative to temperature measured by transducer;	133
Type	c t̄ 4	0/3	0	Type of transducer used: 0 – PT100 (100 Ohm / 0°C); 1 – PT1000 (1000 Ohm / 0°C); 2 – PTC1000 (990 Ohm / 25°C); 3 – PTC (minika).	134
Max. t of channel**	c n̄ 4	-99/999°C	-99	Max. attained temperature;	135
* – The parameter is read-only;					
** – In case of short circuit of transducer, the value of minus 99 is recorded, and in case of transducer breakout – the value of 999 is registered.					

4 DESCRIPTION AND OPERATION OF THE PRODUCT

4.1 Design

The structure of TR-100M is made in plastic housing designed for mounting on the front panel of the board (cabinet) or of the device; dimensions of the housing is 110 x 98 x 96 mm. The housing is made of shockproof, self-extinguishing material. The housing sketch with overall and mounting dimensions is given in Fig.1.1.

4.2 Principle of operation

The product has four channels for temperature measurement, and four output load relays. The temperature transducers of the first three channels measure the temperature of each transformer winding; and the fourth one measures temperature of the transformer yoke.

In case of dangerous temperature rise of the transformer, the product first will enable alarm system and the cooling fans. If the temperature rise continues and the temperature exceeds the limit value, the product will perform emergency shutdown of the transformer.

In case of the temperature transducers fault, TR-100M enables the alarm of the transducer fault.

5 INTENDED USE

5.1 Preparation for operation

5.1.1 Preparation for connection:

- Unpack the product (we recommend to keep the original packing for the entire warranty period of the product operation);
- Check the product for damage after transportation; in case of such damages detection, contact the supplier or

manufacturer;

- Check for components (it.2), in case of detection of incomplete product, contact the supplier or manufacturer;
- Carefully study the Operating Manual (**pay special attention to the connection diagram to power the product**);
- If you have any questions regarding the installation of the product, please contact the manufacturer by telephone number indicated at the end of this Operating Manual.

5.1.2 General instructions

If the temperature of the product after transportation or storage differs from the environment temperature at which it is expected to operate, then before connection to electric mains keep the product under the operating conditions within two hours (because the product elements may have moisture condensation).

ATTENTION!

OUTPUT CONTACTS OF LOAD RELAY ARE NOT DESIGNED FOR LOAD COMMUTATION IN CASE OF SHORT CIRCUITS. THEREFORE THEY SHOULD BE PROTECTED BY AUTOMATIC CIRCUIT BREAKERS (FUSES) WITH TRIPPING CURRENT NOT EXCEEDING 10 A OF CLASS B.

ATTENTION! ALL CONNECTIONS MUST BE PERFORMED WHEN THE PRODUCT IS DE-ENERGIZED.

Error when performing the installation works may damage the product and connected devices.

To ensure the reliability of electrical connections you should use flexible (stranded) wires with insulation for voltage of not less than 450V, the ends of which it is necessary to be striped of insulation for 5 ± 0.5 mm and tightened with bootlaces. Recommended cable cross section for connection of temperature transducers is of 0.5 to 0.75 mm²; to connect the power supply and external devices it should be of 1.0 to 2.5 mm².

TR-100M connection to MODBUS network is made by cable of twisted pair type.

Wires fastening should exclude mechanical damage, twisting and insulation abrasion of wires.

IT IS NOT ALLOWED TO LEAVE EXPOSED PORTIONS OF WIRE PROTRUDING BEYOND THE REMOVABLE TERMINAL BLOCK.

For reliable contact it is necessary to perform tightening of screws of removable terminal block with the force specified in Table 3.1.

When reducing the tightening torque, the junction point is heated, terminal block may be melted and wire can burn. If you increase the tightening torque, it is possible to have thread failure of terminal block screws or the compression of the connected wires.

To improve operational properties of the product it is recommended to install the fuse (fuse element), or the equivalent for current of 3A in power supply circuit for TR-100M.

To reduce the influence of electromagnetic interference:

- All cables which transmit measurement signals from the temperature transducers should be made of shielded cable of twisted pair (triple) type with cross section of at least 0.5mm²;
- When laying the lines of TR-100M – transducer, it is required to separate them into individual conduit run (or several runs). The routes should be located separately from the power cables as well as cables that produce high frequency and impulse noise. The routes should be planned so that the length of signal lines is minimal.

When testing the transformer isolation it is strongly recommended to disable the temperature transducers from TR-100M, since impulse noise (generated during testing) can lead to failure of the product.

5.1.3 Product installation

5.1.3.1 Board design requirements

TR-100M is made as the board design version.

The board design should meet the following requirements:

- The hole for installation of the product should be square of 91.5 x 91.5 mm (tolerance +0.5 mm);
- The distance between the product panels (top, bottom and side ones) and the relevant surfaces of the board should be at least 10 mm;

5.1.3.2 Mounting procedure:

- Put the rubber seal on TR-100M (it.4 Fig. 5.1);
- Install removable terminal blocks (it.3 Fig. 5.1);
- Install the device in the hole of the board;
- Install fasteners (it.2 Fig. 5.1) on the side panels of the product;
- Fasten the product in the board, tightened the fastening screws.

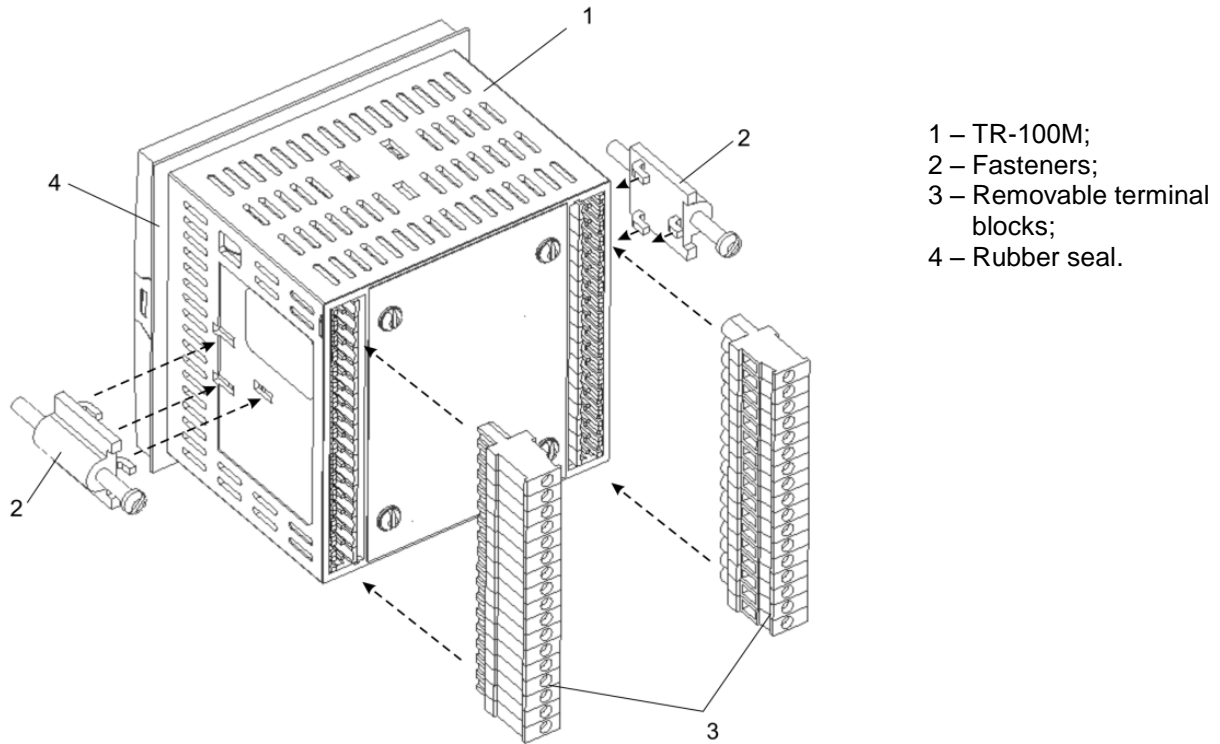

- 1 – TR-100M;
- 2 – Fasteners;
- 3 – Removable terminal blocks;
- 4 – Rubber seal.

Figure 5.1 – Product installation

5.1.4 Product connection

5.1.4.1 Prepare the cables for connection of TR-100M with temperature transducers and external devices as well as power source;

5.1.4.2 Connect the product in accordance with the diagram shown in Fig.5.2.

⚠ ATTENTION! INTENDED FOR CONNECTION OF **POWER SUPPLY AND TERMINALS 1 – 12** INTENDED FOR CONNECTION TO EXTERNAL DEVICES, ARE DESIGNED FOR MAXIMUM VOLTAGE OF **265 V**. TO AVOID ELECTRICAL INSULATION BREAKDOWN, IT IS PROHIBITED TO CONNECT THE SOURCES OF VOLTAGE EXCEEDING THE VALUES SPECIFIED ABOVE.

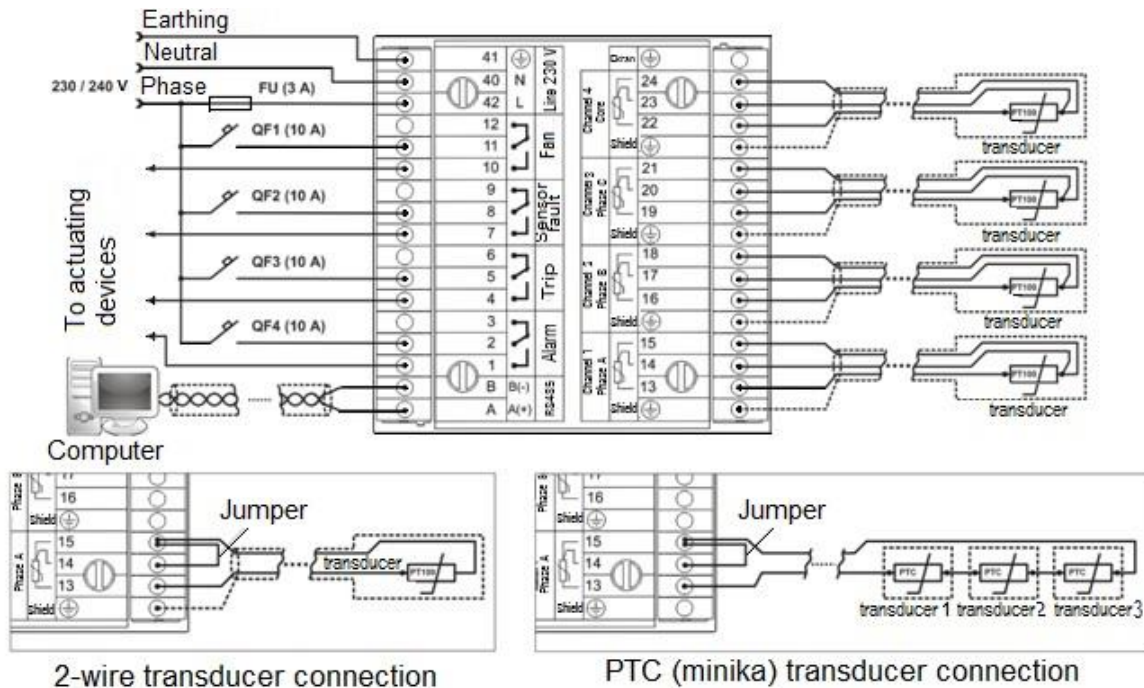

*FU – Fuse (automatic circuit breaker) for current of 3A;
 QF1 - QF4 – Automatic circuit breakers (fuses) for current of 10 A.*

Figure 5.2 – TR-100M Connection Diagram

5.2 Use of the product

In initial state TR-100M alternately, with 4s interval, displays the temperature of enabled transducers and the number of the corresponding channel (if setting value "2" of the parameter is $d5P$ see Table 3.2).

If the temperature of one of enabled transducers exceeds the temperature of the set threshold of ALARM ($R L r$), after the set time ($d L R$) the **ALARM** relay is ON with corresponding indication (it.4 Fig.1.2).

The same thing happens when exceeding the temperature threshold of OVERHEAT ($t r P$), after the set time ($d L R$) the **TRIP** relay is ON with corresponding indication (it.3 Fig.1.2).







Similarly, when exceeding the temperature threshold of COOLING ($F.0 n$), after the set time ($d L R$) the **FAN** relay is ON with corresponding indication (it.11 Fig.1.2).

Disabling of the **ALARM**, **TRIP** and **FAN** relay will occur when the temperature of all enabled transducers is lower than $R L r - d F R$ (Alarm), $t r P - d F t$ (Trip) and $F.0 n - d F F$ (Fan). In this case the corresponding indicators are off.

If in TR-100M all the temperature transducers are disabled, then on the digital display instead of temperature value the blinking inscription " - - - " is shown, and instead of the channel number the blinking mark "-" is displayed.

5.2.1 Product control





The product control is performed as follows:

- to switch between channels, press  or  button;
- to check all LEDs and displays, simultaneously press  and  buttons;
- to enter the parameter view mode, press  button;
- to enter the settings change mode, press and hold for 5 seconds  button;

If you do not press any button within 20 sec, TR-100M will display the inscription "E H t" (for 1 s), and then returns to the initial state.

5.2.2 Display of parameters













To view the parameters you need:

- press once  button, in this case all the LEDs are off, and the display shows the first parameter code "R L r" from Table 3.2;
- for scrolling the parameters, press  or  button;
- to enter the parameter, press  button;
- to exit from the parameter, press  button.

If you do not press any button within 20 sec, TR-100M will returns to the initial state.

Note – In parameter view mode changing of settings is impossible.

5.2.3 Changing of parameters

- 1) To change parameters, press and hold for 5 seconds  button, and then после этого:
 - If you have set the password, enter it. To change the value of the current digit, press  or  button; to move to the next digit, press  button; to confirm the password, press  button. If you do not press any button within 10 sec, TR-100M will returns to the initial state;
 - If the entered password is correct, the LED of **FAULT / PROGRAMMING** is on (it. 5 Fig.1.2) and the digital display will show the first parameter from Table 3.2;
 - If the password entered is incorrect, then TR-100M will return to its original state;
 - If the password is disabled (parameter $P R S$ is set to "000"), the password authentication is not performed. The LED of **FAULT / PROGRAMMING** is on (it.5 Fig.1.2) and the digital display will show the first parameter from Table 3.2.
- 2) To scroll the parameters, press  or  button;
- 3) To enter the parameter, press  button;
- 4) To change the parameter, press  or  button;
- 5) To record the parameter and return to menu, press  button;
- 6) To go back to menu without recording, press  button.

If you do not press any button within 20 sec, TR-100M will returns to the initial state.

5.2.4 Adjustment of cooling parameters



TR-100M can control on/off of the cooling fan, it is necessary to set the parameter value F_{Fn} different from 0 (see Table 3.2):



- **Mode 1** – In this mode the temperature is determined by three transducers 1, 2 and 3. As soon as the temperature of one transducer exceeds the temperature of set threshold for cooling enabling (F_{Fn}), the **FAN** relay is on with corresponding indication (LED 11 flashes, Fig.1.2). The **FAN** relay is off, if temperature of all three transducers drops below than $F_{Fn} - dF.F$;
- **Mode 2** – is similar to Mode 1, except that the temperature is determined by four transducers 1, 2, 3 and 4;
- **Mode 3** – If the channel 4 is enabled ($ch4 = 1$, see Table 3.2). In this mode the temperature is determined by the fourth transducer. As soon as the temperature of the transducer exceeds the temperature of set threshold for cooling enabling (F_{Fn}), the **FAN** relay is on with corresponding indication (LED 11 flashes, Fig.1.2). The **FAN** relay is off, if temperature of the transducer drops below than $F_{Fn} - dF.F$.

Note – The **FAN LED** (it.11 Fig.1.2) is on, when the cooling control is enabled, and it flashes when the temperature of one of transducers exceeds the temperature of the set threshold F_{Fn} (see Table 3.2).

5.2.5 Display of maximum attained temperature

The TR-100M is provided for storage of maximum attained temperature of transducers enabled.

To view the maximum attained temperature, go to the view mode or the mode for changing the parameters (it.5.2.2 or it.5.2.3), using buttons  or  scroll up to the parameter c_{n1} , c_{n2} , c_{n3} or c_{n4} (Channels 1 - 4 respectively) and press  button (entering the parameter).

Reset of the maximum transducer temperature is performed by pressing  button, and return to menu – by pressing  button.



Note – To reset the maximum attained temperature you should be in the mode for parameter changing (it.5.2.3).

5.2.6 Restoring of factory default settings

To restore the factory default settings there are two ways:



The first method: In the mode of changing the parameters, set the parameter $r5t = 1$ and press  button, in this case TR-100M will restart with factory settings. Using this method, the password is not reset;

The second method:

- Energize TR-100M simultaneously holding down  and  buttons, in this case the digital display will show the inscription “ nRU ”;
- Release the buttons;
- Power off, factory settings are restored, including the password (password is 123).

5.2.7 Testing of output load relays

The TR-100M is provided for testing both for all relays together and each relay separately, for this purpose it is necessary:

- 1) In mode of parameters changing, set the parameter value $t5t$ (0 to 4, see Table 3.2) and press  button, in this case the digital display will show the inscription “ oFF ” (which means that the tested load relays are in normally open (off) condition), all LEDs will turn off;
- 2) One time pressing  button, the condition of tested load relays is changed:
 oFF – Relays are in normally open (off) state;
 on – Relays are in normally closed (on) state.

To go back to menu, press  button. If you do not press any button within 20 s, TR-100M will returns to the initial state.

5.2.8 Testing of indication

Press simultaneously  and  buttons, in this case all the LEDs and digital displays should on for 2s.

If at least one of the LEDs or digital displays will not function, TR-100M should be removed from service and send for repair.

5.3 Description of alarm status

FAN, ALARM and TRIP relays will be enabled only when threshold of temperature set by the user is reached.

Transducer **FAULT** relay turns on if there is malfunction of the transducers.

FAULT / PROGRAMMING LED will on when there are failures of TR-100M or transducers are faulty.

In case of failure in one of the temperature transducers connected to TR-100M, depending on the parameter set R_{ct} (see Table 3.2), the LEDs of **FAN** and **ALARM** (it.3, 4 Fig.1.2) start to flash and the digital display shows the fault code.

Types of faults are given in Table 5.1.

Table 5.1 – Types of TR-100M faults

Fault	Description
Calibration error	TR-100M requires calibration. The display shows alternating inscription “E r r <-> c l b”, the product continues normal operation.
Parameter error	TR-100M instead of incorrect parameter downloads the factory setting, in this case the digital display shows the alternating inscription “E r r <-> E r P”, the product continues normal operation.
EEPROM failure	All the load relays are turned off, the digital display shows alternating inscription “E r r <-> E E P”.
Any transducer short circuit	Enabling of transducer FAULT relay, the LEDs of FAULT / PROGRAMMING , ALARM and FAN start flashing. The digital display shows the inscription “F c c”.
Any transducer breakout	Enabling of transducer FAULT relay, the LEDs of FAULT / PROGRAMMING , ALARM and FAN start flashing. The digital display shows the inscription “F o c”.
Exceeding temperature of overheating	FAN relay is enable with corresponding indication in channel.
Exceeding temperature of alarm	ALARM relay is enable with corresponding indication in channel
Exceeding temperature of cooling	FAN relay is enable with corresponding indication in channel

5.4 Temperature transducers

5.4.1 Transducer of PT100 type

It is platinum transducer with rated resistance of 100 Ohms at 0°C. When using the transducers of this type the measurement error is $\pm 2^\circ\text{C}$, the sensors are connected to channels 1, 2, 3 and 4 by two- or three-wire circuit (Fig.5.2) with later setting of “0” $c_{t.1}/c_{t.2}/c_{t.3}/c_{t.4}$ according to the Table 3.2. The range of measured temperatures is from minus 60 to +300°C. TP-100M detects breakdown and short circuit of measuring lines.

5.4.2 Transducer of PT1000 type

It is platinum transducer with rated resistance of 1000 Ohm at 0°C. When using the transducers of this type the measurement error is $\pm 2^\circ\text{C}$, the transducers are connected to channels 1, 2, 3 and 4 by two- or three-wire circuit (Fig.5.2) with later setting of “1” $c_{t.1}/c_{t.2}/c_{t.3}/c_{t.4}$ according to the Table 3.2. The range of measured temperatures is from minus 60 to +300°C. TP-100M detects breakdown and short circuit of measuring lines.

5.4.3 Transducer of PTC1000 (EKS111) type

It is the transducer with rated resistance of 990 Ohm at 25°C. When using the transducers of this type the measurement error is $\pm 2^\circ\text{C}$, the transducers are connected to channels 1, 2, 3 and 4 by two- or three-wire circuit (Fig.5.2) with later setting of “2” $c_{t.1}/c_{t.2}/c_{t.3}/c_{t.4}$ according to the Table 3.2. The range of measured temperatures is from minus 50 to +120°C). TP-100M detects breakdown and short circuit of measuring lines.

5.4.4 Transducer of PTC (minika) type (with positive temperature coefficient of resistance)

It is semiconductor resistor that dramatically changes its electrical resistance when the temperature changes on the housing surface within the range of sensitivity. Cold resistance of the transducer is 20 to 250 Ohms. Sensors can be connected in series to 6 pc (1-3-6) for 1 channel.

Figure 5.3 shows dependency graph of the PTC transducer resistance on the temperature.

The transducers are classified for different in RRT* from 60 to 180°C with increments of 10°C.

The PTC transducers are connected to channels 1, 2 and 4 by two or three-wire circuit (Fig. 5.2) with later setting of “3” parameters $c_{t.1}/c_{t.2}/c_{t.4}$ according to the Table 3.2.

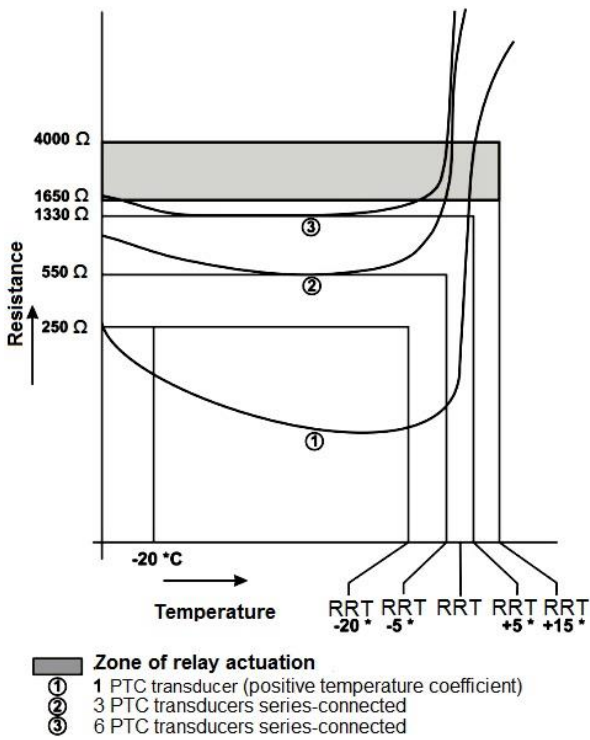

Figure 5.3 – Dependency graph of the PTC transducer resistance on the temperature

5.5 Digital filtering of temperature

For improved performance the TR-100M uses digital filters of the input signals which allows reducing the influence of random noise on the temperature measurement.

The digital filter eliminates the noise signal components by exponential smoothing.

In the product the digital filter has fixed (non-configurable) parameters.

5.6 Remote control of output relays

When setting the parameter of $r_{5A} = 2$ (see Table 3.2) TR-100M is switched to the mode of **Remote control of output relays**. The control registers are specified in Table 5.2 (12 – 15). Filled in these registers the value of 0 or 1, you can enable or disable the corresponding relay.

After enabling the mode of **Remote control of output relays**, the product continues to operate as usual, except that the control of the output relay is transferred to the remote operator.

5.7 Operation with EIA/TIA-485 MODBUS interface

5.7.1 General

TR-100M allows performing data communication with external devices via serial interface EIA/TIA-485 by MODBUS protocol with limited set of commands.

When building the network the organization principle of master – slave is used where the slave is TR-100M. In the network there can be only one master node and several slave nodes. As the master node the personal computer or programmable logic controller acts. In case of this organization the initiator of cycles for exchange can act only the master node.

Requests of the master node are individual (addressed to the specific product). TR-100M transfers data responding to individual requests of the master node.

In case when errors are detected in receiving the requests or the impossibility to fulfill the received command, TR-100M in response generates an error message.

Addresses (in decimal form) of registers of programmable parameters are shown in Table 3.2.

Addresses (in decimal form) of the additional registers and their functions are shown in Table 5.2.

Table 5.2 – Additional registers and their functions

Address Dec	Description	Function	Remark
0	Identifier	It is always equal to 4	
1	Microprogram version	10 (it can be changed by manufacturer)	
2	Status register	bit 0 0 – No fault; 1 – Fault (Code in fault register);	bit 5 – bit 15 reserved
		bit 1 0 – TRIP relay is disabled; 1 – TRIP relay is enabled.	

TR-100M detects short circuit of measuring lines. In the zone of temperatures up to RRT* the display shows “FF”. Upon reaching the RRT* and above the display shows □□.

Note* – **RRT (Rated Response Temperature)** – it is the temperature at which the transducer abruptly changes its electrical resistance.

Table 5.2 (Continued)

Address Dec	Description	Function	Remark
		bit 2 0 – ALARM relay is disabled; 1 – ALARM relay is enabled.	
		bit 3 0 – FAN relay is disabled; 1 – FAN relay is enabled.	
		bit 4 0 – transducer FAULT relay is disabled; 1 – transducer FAULT relay is enabled.	
3	Fault register	bit 0 0 – No fault; 1 – EEPROM failure.	bit 6 – bit 15 reserved
		bit 1 0 – No fault; 1 – Transducer short circuit.	
		bit 2 0 – No fault; 1 – Transducer breakout.	
		bit 3 0 – No fault; 1 – Exceeding the threshold of “Trip”.	
		bit 4 0 – No fault; 1 – Exceeding the threshold of “Alarm”.	
		bit 5 0 – No fault; 1 – Exceeding the threshold of “Fan”.	
4	Transducer 1 status register	bit 0 0 – No fault; 1 – Transducer short circuit.	bit 5 – bit 15 reserved
		bit 1 0 – No fault; 1 – Transducer breakout.	
		bit 2 0 – No fault; 1 – Exceeding the threshold of “Trip”.	
		bit 3 0 – No fault; 1 – Exceeding the threshold of “Alarm”.	
		bit 4 0 – No fault; 1 – Exceeding the threshold of “Fan”.	
5	Transducer 2 status register	Similarly to the transducer 1 status register	
6	Transducer 3 status register	Similarly to the transducer 1 status register	
7	Transducer 4 status register	Similarly to the transducer 1 status register	
8	Temperature 1	Temperature value in °C	Integer
9	Temperature 2	Temperature value in °C	Integer
10	Temperature 3	Temperature value in °C	Integer
11	Temperature 4	Temperature value in °C	Integer
12	TRIP relay control register	0 – relay is disabled; 1 – relay is enabled.	Integer
13	ALARM relay control register	0 – relay is disabled; 1 – relay is enabled.	Integer
14	FAN relay control register	0 – relay is disabled; 1 – relay is enabled.	Integer
15	transducer FAULT relay control register	0 – relay is disabled; 1 – relay is enabled.	Integer

5.7.2 Message formats

The data communication protocol has clearly defined message formats. Adherence to the formats ensures correct and robust operation of the network.

5.7.2.1 Byte format

TR-100M is configured to work with one of the two formats of byte data: with parity control (Fig. 5.4) and no parity (Fig. 5.5). In the mode with parity control the type of control is specified: parity (Even) or oddness (Odd). The transfer of bit data is made by least significant byte first.

By default (during manufacture) the product is configured to work without parity control and with two stop bits.

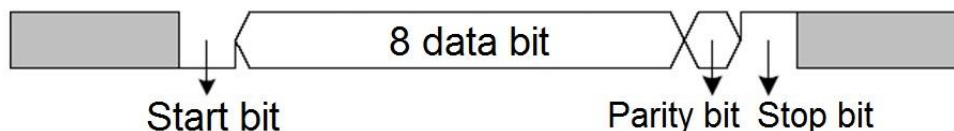

Figure 5.4 – Byte format with parity control

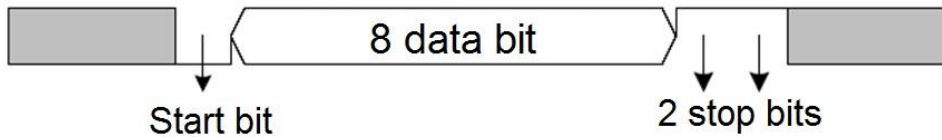

Figure 5.5 – Byte format without parity control (2 stop bits).

Byte transfer is done at rates of 2400, 4800, 9600 and 19200 bps. By default, during manufacture, the product is configured for operation at rate of 9600 bps.

Note – For **MODBUS RTU** mode 8 data bits are transferred, and for **MODBUS ASCII** mode 7 data bits are transferred.

5.7.2.2 Frame format

The frame length cannot exceed 256 bytes for **MODBUS RTU** and 513 bytes for **MODBUS ASCII**.

In mode of Modbus RTU control of start and end of the frame is carried out using intervals of silence with the length not less than transmission time of 3.5 bytes. The frame should be transmitted as continuous stream of bytes. Correctness of frame receiving additionally is controlled by checksum CRC.

The address field occupies one byte. Slave addresses are in the range from 1 to 247.

Figure 5.6 presents the RTU frame format.

Intervals of silence > 3.5 byte	Address	Function code	Data	Checksum CRC	Intervals of silence > 3.5 byte
	1 byte	1 byte	Up to 252 bytes	2 bytes	

Figure 5.6 – RTU Frame Format

In mode of **MODBUS ASCII** control of start and end of the frame is carried out using special symbols (symbol (‘:’ 0x3A) – for frame start; symbols (‘CRLF’ 0x0D0x0A) – for the frame end). The frame should be transmitted as continuous stream of bytes. Correctness of frame receiving additionally is controlled by checksum LRC.

The address field occupies two bytes. Slave addresses are in the range from 1 to 247.

Figure 5.7 presents the ASCII frame format.

: 1 byte	Address	Function code	Data	Checksum LRC	CRLF 2 bytes
	2 bytes	2 bytes	Up to 504 bytes	2 bytes	

Figure 5.7 –ASCII Frame Format

Note – In mode **MODBUS ASCII** each data byte is encoded as two bytes of ASCII code (e.g.:1 byte 0x25 data is encoded in two bytes ASCII code 0x32 and 0x35).

5.7.3 Generation and verification of check sum

The transmitting device forms the checksum for all bytes of the message transmitted. TR-100M likewise forms the checksum for all bytes of the message received and compares it with the checksum received from the transmitting device. If there is no match with the generated checksum and received one the error message is generated.

5.7.3.1 Generation of check sum of CRC

The checksum in the message is transferred with low byte first, it is a cyclic check code based on an irreducible polynomial 0xA001.

Subprogram of formation of checksum CRC using C:

```

1:  uint16_t Generate CRC (uint8_t *pSendRecvBuf, uint16_t uCount)
2:  {
3:      cons uint16_t Polynom = 0xA001;
4:      uint16_t crc = 0xFFFF;
5:      uint16_t i;
6:      uint8_t byte;
7:      for(i=0; i<(uCount-2); i++){
8:          crc = crc ^ pSendRecvBuf[i];
9:          for(byte=0; byte<8; byte++){
10:             if((crc& 0x0001) == 0){
11:                 crc = crc>> 1;
12:             }else{
13:                 crc = crc>> 1;

```



```

14:         crc = crc ^ Polynom;
15:}
16:}
17:}
18: returncrc;
19:}
    
```

5.7.3.2 Generation of check sum of LRC

The checksum in the message is transmitted by significant byte first, represents the longitudinal control of redundancy.

Subprogram of formation of checksum LRC using C:

```

1: uint8_t Generate LRC (uint8_t *pSendRecvBuf, uint16_t uCount)
2: {
3:     uint8_t lrc = 0x00;
4:     uint16_t i;
5:     for(i=0; i<(uCount-1); i++){
6:         lrc = (lrc + pSendRecvbuf[i]) & 0xFF;
7:     }
8:lrc = ((lrc ^ 0xFF) + 2) & 0xFF;
9:returnlrc;
10: }
    
```

5.7.4 Command system

5.7.4.1 Function 0x03 – Reading of register group

Function 0x03 provides reading of TR-100M register content. The request of the master contains the address of the initial register, as well as the number of words to read.

TR-100M response contains the number of returned bytes and the requested data. The number of returned registers is limited to 50.If the number of registers in the request exceeds 50 (100 bytes), the partition of the response into frames is not performed.

Example of request and response in **Modbus RTU** is given in Fig.5.8.

Request

Address	Function	Start address HB	Start address LB	QTY of words HB	QTY of words LB	CRC LB	CRC HB
01h	03h	00h	A0h	00h	02h	C4h	29h

Response – Register value 00A0h = 1000 (FLOAT)

Address	Function	Byte QTY	Data HW HB	Data HW LB	Data LW HB	Data LW LB	CRC LB	CRC HB
01h	03h	04h	44h	7Ah	00h	00h	CFh	1Ah

Figure 5.8 – Example of request and response of functions 0x03 – Reading of register group

5.7.4.2 Function 0x06 – Recording of the register

Function 0x06 provides recording in one register of TR-100M. The master request contains the register address and data to be recorded.

The response of the product matches the master request and contains the address of the register and set data. Example of request and response in mode **Modbus RTU** is given in Fig.5.9.

Request – register 00A0h = 1000 (INT)

Address	Function	Start address HB	Start address LB	Data HB	Data LB	CRC LB	CRC HB
01h	06h	00h	A0h	03h	E8h	89h	56h

Response

Address	Function	Start address HB	Start address LB	Data HB	Data LB	CRC LB	CRC HB
01h	06h	00h	A0h	03h	E8h	89h	56h

Figure 5.9 – Example of request and response for functions 0x06 – the register setting

5.7.4.3 Function 0x08 – Diagnostics

Function 0x08 provides a number of tests for checking of communication system between the master and TR-100M, as well as for checking of various internal conditions of TR-100M.

The function uses the sub function field to specify the action performed (test).

Sub-function 0x00 – return of the request data

The data transmitted in the data field of the request will be returned in the response data field.

Example of request and response in mode of **MODBUSRTU** is given in Fig. 5.10.

Request

Address	Function	Sub-function HB	Sub-function LB	Data HB	Data LB	CRC LB	CRC HB
01h	08h	00h	A0h	A0h	3Ch	98h	1Ah

Response

Address	Function	Sub-function HB	Sub-function LB	Data HB	Data LB	CRC LB	CRC HB
01h	08h	00h	00h	A0h	3Ch	98h	1Ah

Figure 5.10 – Example of request and response for sub-function 0x00– return of request data

Sub-function 0x01 – restart of communication options

Peripheral port of TR-100M will be initialized and restarted.

Response will not return.

Example of request in mode of **MODBUSRTU** is given in Fig.5.11.

Request

Address	Function	Sub-function HB	Sub-function LB	Data HB	Data LB	CRC LB	CRC HB
01h	08h	00h	01h	00h	00h	B1h	CBh

Response is not returned.

Figure 5.11 – Example of request and response for sub-function 0x01– restart of communication options

Sub-function 04h – set the mode To Listen Only

This mode has TR-100M to go to the mode **To Listen Only**. The command isolates the product from other devices of the network, eliminating its influence on the exchange process. No response is returned. Any subsequent commands addressed to this TR-100M, will be accepted, but replies will not be returned. Exit from mode **To listen Only** is possible only when you receive diagnostic command with sub-function 0x01 – restart of communication options.

Example of request and response in the mode of **MODBUS RTU** is given in Fig.5.12.

Request

Address	Function	Sub-function HB	Sub-function LB	Data HB	Data LB	CRC LB	CRC HB
01h	08h	00h	04h	00h	00h	A1h	CAh

Response is not returned.

Figure 5.12– Example of request and response for sub-function 0x04 – set the mode **To Listen Only**

6 MAINTENANCE

6.1 Safety precautions



THE TERMINALS AND THE PRODUCT INTERNAL ELEMENTS CONTAINS POTENTIALLY LETHAL VOLTAGE.

DURING MAINTENANCE IT IS NECESSARY TO DISABLE THE PRODUCT AND CONNECTED DEVICES FROM THE MAINS

6.2 Maintenance of the product must be performed by qualified service personnel.

6.3 Recommended frequency of maintenance **is every six months.**

6.4 Maintenance procedure:

- 1) Check the connection reliability of the wires, if necessary, clamp with the force specified in Table 3.1;
- 2) Visually check the integrity of the housing, in case of detection of cracks and damages to remove the product from service and send for repair;
- 3) If necessary, wipe with cloth the front panel and the product housing.

Do not use abrasives and solvents for cleaning.

7 SERVICE LIFE AND MANUFACTURER WARRANTY

7.1 The lifetime of the product is 15 years. Upon expiration of the service life, contact the manufacturer.

7.2 Shelf life is 3 years.

7.3 Warranty period of the product operation is 5 years from the date of sale.

During the warranty period of operation (in the case of failure of the product) the manufacturer is responsible for free repair of the product.

ATTENTION! IF THE PRODUCT HAS BEEN OPERATED IN VIOLATION OF THE REQUIREMENTS OF THIS MANUAL, THE MANUFACTURER HAS THE RIGHT TO REFUSE IN WARRANTY SERVICE.

7.4 Warranty service is performed at the place of purchase or by the manufacturer of the product.

7.5 Post-warranty service of the product is performed by the manufacturer at current rates.

7.6 Before sending for repair, the product should be packed in the original or other packing excluding mechanical damage.

You are kindly requested, in case of return of the product and transfer it to the warranty (post-warranty) service, in the field of the claims data, list the detailed reason for return.

8 TRANSPORTATION AND STORAGE

The product in the original package is permitted to be transported and stored at the temperature from minus 45 to +60°C and relative humidity of 80%.

9 ACCEPTANCE CERTIFICATE

TR-100M has been manufactured and accepted in accordance with the requirements of current technical documentation and classified as fit for operation.