



Pages 18-4 to 7

VOLTAGE MONITORING RELAYS

- For three-phase systems with or without neutral and single-phase systems
- Minimum and maximum AC voltage
- Phase loss and incorrect phase sequence
- Asymmetry
- Minimum and maximum frequency.



Pages 18-8 and 9

CURRENT MONITORING RELAYS

- For single and three-phase systems
- Maximum AC/DC current
- Minimum or maximum AC/DC current
- Minimum and maximum AC/DC current.



Page 18-10

PUMP PROTECTION RELAYS

- For single and three-phase systems
- Minimum $\cos\phi$ for dry running protection
- Maximum AC current
- Phase loss and incorrect phase sequence.



Page 18-11

PHASE SHIFT MONITORING RELAYS

- For single and three-phase systems
- Minimum $\cos\phi$
- Maximum $\cos\phi$.



Page 18-11

FREQUENCY MONITORING RELAYS

- For single and three-phase systems
- Minimum frequency
- Maximum frequency.



Page 18-12

INTERFACE PROTECTION SYSTEM UNITS

- Compliant with Italian standard CEI 0-21, for low voltage
- Compliant with Italian standard CEI 0-16, for medium voltage.



- Modular version for switchgear panels, also suitable for rear mounting plate fixing
- Minimum and maximum voltage monitoring relays for single and three-phase systems, with or without neutral
- Voltage asymmetry, phase sequence and phase loss control relays
- Minimum and maximum current monitoring relays
- Frequency monitoring relays
- Interface protection system units compliant with Italian standards CEI 0-21 and CEI 0-16.

	SEC. - PAGE
Modular voltage monitoring relays	
For three-phase systems, without neutral	18 - 4
For three-phase systems, with or without neutral	18 - 6
For single-phase systems	18 - 7
Modular current monitoring relays	
For single systems	18 - 8
For single and three-phase systems	18 - 9
Modular pump protection relays	18 - 10
Modular phase shift monitoring relays	18 - 11
Modular frequency monitoring relays	18 - 11
Interface protection system units	18 - 12
Dimensions	18 - 17
Wiring diagrams	18 - 18
Technical characteristics	18 - 30

Voltage monitoring relays for three-phase systems without neutral



	PMV10	PMV20	PMV30	PMV40	PMV50	PMV70
Modular version	●(1U)	●(2U)	●(2U)	●(2U)	●(2U)	●(2U)
Minimum AC voltage			●		●	●
Maximum AC voltage					●	●
Phase loss	●	●	●	●	●	●
Incorrect phase sequence	●	●	●	●	●	●
Asymmetry				●		
Page		18-4			18-5	18-5

Voltage monitoring relays for three-phase systems with or without neutral



	PMV50N	PMV70N	PMV80N
Modular version	●(3U)	●(3U)	●(3U)
Minimum AC voltage	●	●	●
Maximum AC voltage	●	●	●
Phase loss	●	●	●
Neutral loss	●	●	●
Incorrect phase sequence	●	●	●
Asymmetry		●	
Minimum frequency			●
Maximum frequency			●
Page	18-6	18-6	18-7

18

Voltage monitoring relay for single-phase systems



	PMV55
Modular version	●(2U)
Minimum AC voltage	●
Maximum AC voltage	●
Page	18-7

Current monitoring relays for single and three-phase systems



	PMA20	PMA30	PMA40
Modular version	●(2U)	●(2U)	●(3U)
Maximum AC/DC current	●		
Minimum or maximum AC/DC current		●	
Minimum and maximum AC/DC current			●
Page	18-8		18-9

Pump protection relay for single and three-phase systems



Phase shift monitoring relay for single and three-phase systems



	PMA50
Modular version	●(3U)
Minimum $\cos\phi$ for dry running pump protection	●
Maximum AC current	●
Phase loss	●
Incorrect phase sequence	●
Page	18-10

	PMA60
Modular version	●(3U)
Minimum $\cos\phi$	●
Maximum $\cos\phi$	●
Page	18-11

Frequency monitoring relay for single and three-phase systems



Interface protection system compliant with Italian standard CEI 0-16, for medium voltage



	PMF20
Modular version	●(2U)
Minimum frequency only	●
Maximum frequency only	●
Page	18-11

	PMVF30
Version	Flush mount (96x96mm/3.78x3.78")
Dual threshold voltage/frequency	●
Voltage release	●
Page	18-14

Interface protection system compliant with Italian standard CEI 0-21, for low voltage



	PMVF20	PMVF51
Version	Flush mount (96x96mm/3.78x3.78")	Modular (6U)
Dual threshold min and max voltage	●	●
Dual threshold min and max frequency	●	●
Page	18-12	18-13

For three-phase systems, without neutral



PMV10 A440

Order code	Rated voltage to control Ue (phase to phase)	Qty per pkg	Wt
	[V] 50/60Hz	n°	[kg]

Three-phase system, without neutral. Phase loss and incorrect phase sequence. Instantaneous trip. 1 module housing.

PMV10 A440	208...480VAC	1	0.050
PMV20 A240	100...240VAC	1	0.120
PMV20 A575	208...575VAC	1	0.120
PMV20 A600	380...600VAC	1	0.120

2 modules housing.

General characteristics

- Voltage monitoring relay, self powered, for phase loss and incorrect phase sequence
- Phase loss detection if one of the voltages is <70% rated value
- Phase loss tripping time: 60ms
- 1 relay output with 1 changeover contact (SPDT)
- Modular DIN 43880 housing: 1 module for PMV10; 2 module for PMV20
- IEC degree of protection: IP40 on front (only when placed in IP40 enclosure or control board); IP20 at terminals.

Certifications and compliance

Certifications obtained: EAC; UL Listed, for USA and Canada (cULus - File E93601) as Auxiliary Devices. Compliant with standards: IEC/EN 60255-5, IEC/EN 61000-6-2, IEC/EN 61000-6-3, UL 508, CSA C22.2 n° 14.

Operational diagram

See page 18-18.



PMV20...

Order code	Rated voltage to control Ue (phase to phase)	Qty per pkg	Wt
	[V] 50/60Hz	n°	[kg]

Three-phase system, without neutral. Minimum AC voltage. Delayed trip. Phase loss and incorrect phase sequence. Instantaneous trip.

PMV30 A240	208...240VAC	1	0.130
PMV30 A575	380...575VAC	1	0.130
PMV30 A600	600VAC	1	0.130

General characteristics

- Voltage monitoring relay, self powered, for minimum voltage, phase loss and incorrect phase sequence
- Configurable rated voltage (Ue):
 - PMV30 A240: 208-220-230-240VAC
 - PMV30 A575: 380-400-415-440-460-480-525-575VAC
- Excellent tripping accuracy
- TRMS measurements (True Root Mean Square)
- Control of phase-to-phase voltages
- Phase loss detection if one of the voltages is <70% rated value
- Phase loss tripping time: 60ms
- 1 relay output with 1 changeover contact (SPDT)
- Modular DIN 43880 housing, 2 module
- IEC degree of protection: IP40 on front (only when placed in IP40 enclosure or control board); IP20 at terminals.

ADJUSTMENTS

- "V min" Minimum voltage tripping threshold 80...95% Ue
- "Delay" Tripping time 0.1...20s
- "Reset delay" Resetting time 0.1...20s.

Certifications and compliance

Certifications obtained: EAC; UL Listed, for USA and Canada (cULus - File E93601), as Auxiliary Devices. Compliant with standards: IEC/EN 60255-5, IEC/EN 61000-6-2, IEC/EN 61000-6-3, UL 508, CSA C22.2 n° 14.

Operational diagram

See page 18-18.



PMV30...

Order code	Rated voltage to control Ue (phase-to-phase)	Qty per pkg	Wt
	[V] 50/60Hz	n°	[kg]

Three-phase system, without neutral. Asymmetry. Delayed trip. Phase loss and incorrect phase sequence. Instantaneous trip.

PMV40 A240	208...240VAC	1	0.130
PMV40 A575	380...575VAC	1	0.130
PMV40 A600	600VAC	1	0.130

General characteristics

- Voltage monitoring relay, self powered, for asymmetry, phase loss and incorrect phase sequence
- Excellent tripping accuracy
- TRMS measurements (True Root Mean Square)
- Control of phase-to-phase voltages
- Phase loss detection if one of the voltages is <70% rated value
- Phase loss tripping time: 60ms
- 1 relay output with 1 changeover contact (SPDT)
- Modular DIN 43880 housing, 2 module
- IEC degree of protection: IP40 on front (only when placed in IP40 enclosure or control board); IP20 at terminals.

ADJUSTMENTS

- "Asymmetry" High voltage asymmetry tripping threshold 5...15% Ue
- "Delay" Tripping time 0.1...20s
- "Reset delay" Resetting time 0.1...20s.

Certifications and compliance

Certifications obtained: EAC; UL Listed, for USA and Canada (cULus - File E93601), as Auxiliary Devices. Compliant with standards: IEC/EN 60255-5, IEC/EN 61000-6-2, IEC/EN 61000-6-3, UL 508, CSA C22.2 n° 14.

Operational diagram

See page 18-18.



PMV40...

For three-phase systems, without neutral



PMV50...

Order code	Rated voltage to control Ue (phase-to-phase)	Qty per pkg	Wt
	[V] 50/60Hz	n°	[kg]

Three-phase system, without neutral.
Minimum and maximum AC voltage. Delayed trip.
Phase loss and incorrect phase sequence. Instantaneous trip.

PMV50 A240	208...240VAC	1	0.130
PMV50 A575	380...575VAC	1	0.130
PMV50 A600	600VAC	1	0.130

General characteristics

- Voltage monitoring relay, self powered, for minimum and maximum voltage, phase loss and incorrect phase sequence
- Configurable rated voltage (Ue):
 - PMV50 A240: 208-220-230-240VAC
 - PMV50 A575: 380-400-415-440-460-480-525-575VAC
- High tripping accuracy
- TRMS measurements (True Root Mean Square)
- Control of phase-to-phase voltages
- Phase loss detection if one of the voltages is <70% rated value
- Phase loss tripping time: 60ms
- 1 relay output with 1 changeover contact (SPDT)
- Modular DIN 43880 housing, 2 module
- IEC degree of protection: IP40 on front (only when placed in IP40 enclosure or control board); IP20 on terminals.

ADJUSTMENTS

- “V max” Maximum voltage tripping threshold
105...115% Ue
- “V min” Minimum voltage tripping threshold
80...95% Ue
- “Delay” for each Tripping time 0.1...20s
- “Reset delay” Resetting time 0.1...20s.

Certifications and compliance

Certifications obtained: EAC; UL Listed, for USA and Canada (cULus - File E93601) as Auxiliary Devices.
Compliant to standards: IEC/EN 60255-5, IEC/EN 61000-6-2, IEC/EN 61000-6-3, UL 508, CSA C22.2 n° 14.

Operational diagram

See page 18-18.



PMV70...

Order code	Rated voltage to control Ue (phase to phase)	Qty per pkg	Wt
	[V] 50/60Hz	n°	[kg]

Three-phase system, without neutral.
Minimum and maximum AC voltage and asymmetry.
Delayed trip.
Phase loss and incorrect phase sequence. Instantaneous trip.

PMV70 A240	208...240VAC	1	0.130
PMV70 A575	380...575VAC	1	0.130
PMV70 A600	600VAC	1	0.130

General characteristics

- Voltage monitoring relay, self powered, for minimum and maximum voltage, phase loss, incorrect phase sequence and asymmetry
- Configurable rated voltage (Ue):
 - PMV70 A240: 208-220-230-240VAC
 - PMV70 A575: 380-400-415-440-460-480-525-575VAC
- Excellent tripping accuracy
- TRMS measurements (True Root Mean Square)
- Control of phase-to-phase voltages
- Phase loss detection if one of the voltages is <70% rated value
- Phase loss tripping time: 60ms
- 1 relay output with 1 changeover contact (SPDT)
- Modular DIN 43880 housing, 2 module
- IEC degree of protection: IP40 on front (only when placed in IP40 enclosure or control board); IP20 at terminals.

ADJUSTMENTS

- “V max” Maximum voltage tripping threshold
105...115% Ue
- “V min” Minimum voltage tripping threshold
80...95% Ue
- “Delay” for each Tripping delay 0.1...20s
- “Asymmetry” High voltage asymmetry tripping threshold 5...15% Ue.

Certifications and compliance

Certifications obtained: EAC; UL Listed, for USA and Canada (cULus - File E93601), as Auxiliary Devices.
Compliant with standards: IEC/EN 60255-5, IEC/EN 61000-6-2, IEC/EN 61000-6-3, UL 508, CSA C22.2 n° 14.

Operational diagram

See page 18-18.

For three-phase systems with or without neutral



PMV50N...

Order code	Rated voltage to control Ue (phase to phase)	Qty per pkg	Wt
	[V] 50/60Hz	n°	[kg]

Three-phase system, with or without neutral.
Minimum and maximum AC voltage. Delayed trip.
Phase loss, neutral loss and incorrect phase sequence.
Instantaneous trip.

PMV50N A240	208...240VAC	1	0.200
PMV50N A440	380...440VAC	1	0.200
PMV50N A600	480...600VAC	1	0.200

General characteristics

- Voltage monitoring relay, self powered, for minimum and maximum voltage, phase loss, neutral loss and incorrect phase sequence
- 4 configurable rated voltage (Ue):
 - PMV50N A240: 208-220-230-240VAC (phase-phase) 120-127-132-138VAC (phase-neutral)
 - PMV50N A440: 380-400-415-440VAC (phase-phase) 220-230-240-254VAC (phase-neutral)
 - PMV50N A600: 480-525-575-600VAC (phase-phase) 277-303-332-347VAC (phase-neutral)
- Excellent tripping accuracy
- TRMS measurements (True Root Mean Square)
- Phase loss detection when one of the voltages is <70% rated voltage
- Phase or neutral loss tripping time: 60ms
- 2 relay outputs, each with 1 changeover contact (SPDT)
- Modular DIN 43880 housing, 3 module
- IEC degree of protection: IP40 on front (only when placed in IP40 enclosure or control board); IP20 at terminals.

ADJUSTMENTS

- “V max” Maximum voltage tripping threshold 105...115% Ue
- “V min” Minimum voltage tripping threshold 80...95% Ue
- “Delay” for each Tripping time 0.1...20s
- “Reset Delay” Resetting time 0.1...20s.

Certifications and compliance

Certifications obtained: EAC.
Compliant with standards: IEC/EN 60255-5, IEC/EN 61000-6-2, IEC/EN 61000-6-3, UL 508, CSA C22.2 n° 14.

Operational diagram

See page 18-19.



PMV70N...

Order code	Rated voltage to control Ue (phase to phase)	Qty per pkg	Wt
	[V] 50/60Hz	n°	[kg]

Three-phase system, with or without neutral.
Minimum and maximum AC voltage and asymmetry.
Delayed trip.
Phase loss, neutral loss and incorrect phase sequence.
Instantaneous trip.

PMV70N A240	208...240VAC	1	0.200
PMV70N A440	380...440VAC	1	0.200
PMV70N A600	480...600VAC	1	0.200

General characteristics

- Voltage monitoring relay, self powered, for minimum and maximum voltage, phase loss, neutral loss, incorrect phase sequence and asymmetry
- 4 configurable rated voltage (Ue):
 - PMV70N A240: 208-220-230-240VAC (phase-phase) 120-127-132-138VAC (phase-neutral)
 - PMV70N A440: 380-400-415-440VAC (phase-phase) 220-230-240-254VAC (phase-neutral)
 - PMV70N A600: 480-525-575-600VAC (phase-phase) 277-303-332-347VAC (phase-neutral)
- Excellent tripping accuracy
- TRMS measurements (True Root Mean Square)
- Phase loss detection when one of the voltages is <70% rated value
- Phase or neutral loss tripping time: 60ms
- 2 relay outputs, each with 1 changeover contact (SPDT)
- Modular DIN 43880 housing, 3 module
- IEC degree of protection: IP40 on front (only when placed in IP40 enclosure or control board); IP20 at terminals.

ADJUSTMENTS

- “V max” Maximum voltage tripping threshold 105...115% Ue
- “V min” Minimum voltage tripping threshold 80...95% Ue
- “Delay” for each Tripping time 0.1...20s
- “Asymmetry” High voltage asymmetry tripping threshold 5...15% Ue.

Certifications and compliance

Certifications obtained: EAC.
Compliant with standards: IEC/EN 60255-5, IEC/EN 61000-6-2, IEC/EN 61000-6-3, UL 508, CSA C22.2 n° 14.

Operational diagram

See page 18-19.

For three-phase systems, with or without neutral



PMV80N...

Order code	Rated voltage to control Ue (phase to phase)	Qty per pkg	Wt
	[V] 50/60Hz	n°	[kg]

Three-phase system, with or without neutral.
Minimum and maximum AC voltage, minimum and maximum frequency. Delayed trip.
Phase loss, neutral loss and incorrect phase sequence.
Instantaneous trip.

PMV80N A240	208...240VAC	1	0.200
PMV80N A440	380...440VAC	1	0.200
PMV80N A600	480...600VAC	1	0.200

General characteristics

- Voltage monitoring relay, self powered, for minimum and maximum voltage, minimum and maximum frequency, phase loss, neutral loss and incorrect phase sequence
- 4 configurable rated voltage (Ue):
 - PMV80N A240: 208-220-230-240VAC (phase-phase) 120-127-132-138VAC (phase-neutral)
 - PMV80N A440: 380-400-415-440VAC (phase-phase) 220-230-240-254VAC (phase-neutral)
 - PMV80N A600: 480-525-575-600VAC (phase-phase) 277-303-332-347VAC (phase-neutral)
- Excellent tripping accuracy
- TRMS measurements (True Root Mean Square)
- Phase loss detection if one of the voltages is <70% rated value
- Phase or neutral loss tripping time: 60ms
- 2 relay outputs, each with 1 changeover contact (SPDT)
- Modular DIN 43880, 3 module
- IEC degree of protection: IP40 on front (only when placed in IP40 enclosure or control board); IP20 at terminals.

ADJUSTMENTS

“V max”	Maximum voltage tripping threshold 105...115% Ue
“V min”	Minimum voltage tripping threshold 80...95% Ue
“Hz min/max”	Minimum/maximum frequency tripping threshold 1...10%
“V delay”	Tripping time 0.1...20s
“Hz delay”	Tripping time 0.1...5s.

Certifications and compliance

Certifications obtained: EAC.
Compliant with standards: IEC/EN 60255-5, IEC/EN 61000-6-2, IEC/EN 61000-6-3, UL 508, CSA C22.2 n° 14.

Operational diagram

See page 18-19.

For single-phase systems



PMV55...

Order code	Rated voltage to control Ue	Qty per pkg	Wt
	[V] 50/60Hz	n°	[kg]

Single-phase system.
Minimum and maximum AC voltage. Delayed trip.

PMV55 A240	208...240VAC	1	0.125
PMV55 A440	380...440VAC	1	0.125

General characteristics

- Voltage monitoring relay, self powered, for minimum and maximum voltage
- 4 configurable rated voltage (Ue):
 - PMV55 A240: 208-220-230-240VAC
 - PMV55 A440: 380-400-415-440VAC
- Excellent tripping accuracy
- TRMS measurements (True Root Mean Square)
- 1 relay output with 1 changeover contact (SPDT)
- Modular DIN 43880 housing, 2 module
- IEC degree of protection: IP40 on front (only when placed in IP40 enclosure or control board); IP20 at terminals.

ADJUSTMENTS

“V max”	Maximum voltage tripping threshold 105...115% Ue
“V min”	Minimum voltage tripping threshold 80...95% Ue
“Delay” for each	Tripping time 0.1...20s
“Reset delay”	Resetting time 0.1...20s.

Certifications and compliance

Certifications obtained: EAC; UL Listed, for USA and Canada (cULus - File E93601), as Auxiliary Devices.
Compliant with standards: IEC/EN 60255-5, IEC/EN 61000-6-2, IEC/EN 61000-6-3, UL 508, CSA C22.2 n° 14.

Operational diagram

See page 18-19.

For single-phase systems



PMA20 240

Order code	Rated current I_n	Auxiliary supply voltage	Qty per pkg	Wt
	[A]	[V]	n°	[kg]

Single-phase system.
AC/DC maximum current control.
Auxiliary AC/DC power supply.
Automatic or manual reset.

PMA20 240	5 or 16A	24...240V AC/DC	1	0.121
------------------	----------	--------------------	---	-------

General characteristics

- Current monitoring relay for AC/DC maximum current control, AC/DC multivoltage auxiliary power supply
- Direct connection up to 16A max or by current transformer (CT)
- Excellent tripping accuracy
- TRMS current measurements (True Root Mean Square)
- Resetting and inhibition input
- 1 relay output with 1 changeover contact (SPDT)
- Modular DIN 43880 housing, 2 module
- IEC degree of protection: IP40 on front (only when placed in IP40 enclosure or control board); IP20 at terminals.

ADJUSTMENTS

- "I_{max}" Maximum current tripping threshold
5...100% I_n
- "Hysteresis" Maximum hysteresis threshold
1...50%
- "Trip delay" Tripping time 0.1...30s
- "Inhibition time" Inhibition delay for external input or at power up 1...60s
- "Aut. reset delay" Automatic resetting time 0.1...30s
- "Mode"
- Rated current 5A or 16A
 - Relay output normally energised or de-energised
 - Tripping memory (Latch) On or Off.

Certifications and compliance

Certifications obtained: EAC; UL Listed, for USA and Canada (cULus - File E93601), as Auxiliary Devices - Modular ampere monitoring relays.
Compliant with standards: IEC/EN 60255-5, IEC/EN 61000-6-2, IEC/EN 61000-6-3, UL 508, CSA C22.2 n° 14.

Operational diagram

See page 18-20.

For single and three-phase systems



PMA30 240

Order code	Rated current I_e	Auxiliary supply voltage	Qty per pkg	Wt
	[A]	[V]	n°	[kg]

Single and three-phase system.
AC/DC minimum or maximum current control. Delayed trip.
Auxiliary AC/DC power supply.
Automatic or manual reset.

PMA30 240	5 or 16A	24...240V AC/DC	1	0.121
------------------	----------	-----------------	---	-------

General characteristics

- Current monitoring relay for AC/DC minimum or maximum current control; AC/DC multivoltage auxiliary power supply
- Direct connection up to 16A max or by current transformer (CT)
- Excellent tripping accuracy
- TRMS current measurements (True Root Mean Square)
- Resetting and inhibition input
- 1 relay output with 1 changeover contact (SPDT)
- Modular DIN 43880 housing, 2 module
- IEC degree of protection: IP40 on front (only when placed in IP40 enclosure or control board); IP20 at terminals.

ADJUSTMENTS

"Set point"	Minimum or maximum current tripping threshold 5...100% I_e
"Hysteresis"	Minimum or maximum hysteresis threshold 1...50%
"Trip delay"	Tripping time 0.1...30s
"Inhibition time"	Inhibition delay for external input or at power up 1...60s
" I_e "	Current scale selection: 5A or 16A
"Mode"	<ul style="list-style-type: none"> • Min or max function • Relay output normally energised or de-energised • Tripping memory (Latch) On or Off.

Certifications and compliance

Certifications obtained: EAC; UL Listed, for USA and Canada (cULus - File E93601), as Auxiliary Devices - Modular ampere monitoring relays.
Compliant with standards: IEC/EN 60255-5, IEC/EN 61000-6-2, IEC/EN 61000-6-3, UL 508, CSA C22.2 n° 14.

Operational diagram

See pages 18-21 and 22.



PMA40 240

Order code	Rated current I_e	Auxiliary supply voltage	Qty per pkg	Wt
	[A]	[V]	n°	[kg]

Single and three-phase system.
AC/DC minimum and maximum current control. Delayed trip.
Auxiliary AC/DC power supply.
Automatic or manual reset.

PMA40 240	0.02-0.05-0.25-1-5-16A	24...240V AC/DC	1	0.166
------------------	------------------------	-----------------	---	-------

General characteristics

- Current monitoring relay for AC/DC minimum and maximum current control, AC/DC multivoltage auxiliary power supply
- Direct connection up to 16A max or by current transformer (CT)
- Excellent tripping accuracy
- TRMS current measurements (True Root Mean Square)
- Automatic or manual resetting (manual resetting by power removal)
- 2 relay outputs (Min and Max), configurable, each with 1 changeover contact (SPDT)
- Modular DIN 43880 housing, 3 module
- IEC degree of protection: IP40 on front (only when placed in IP40 enclosure or control board); IP20 at terminals.

ADJUSTMENTS

" I_{max} "	Maximum current tripping threshold 5...100% I_e
" I_{min} "	Minimum current tripping threshold 5...100% I_e
"Trip delay"	Minimum and maximum current tripping time 0.1...30s
"Inhibition time"	Inhibition time at power up 1...60s
" I_e "	Current scale selection: 20mA, 50mA, 250mA, 1A, 5A or 16A
"Mode"	<ul style="list-style-type: none"> • Separate or common relay outputs • Relay output normally energised or de-energised • Tripping memory (Latch) On or Off.

Certifications and compliance

Certifications obtained: EAC; UL Listed, for USA and Canada (cULus - File E93601), as Auxiliary Devices - Modular ampere monitoring relays.
Compliant with standards IEC/EN 60255-5, IEC/EN 61000-6-2, IEC/EN 61000-6-3, UL 508, CSA C22.2 n° 14.

Operational diagram

See page 18-22 and 23.

For single and three-phase systems



PMA50...

Order code	Rated current I _e	Auxiliary supply voltage	Qty per pkg	Wt
	[A]	[V]	n°	[kg]

Single and three-phase systems.
Maximum AC current and minimum cosφ. Delayed trip.
Phase loss and incorrect phase sequence. Instantaneous trip.
Auxiliary AC power supply.
Automatic or manual reset.

PMA50 A240	5 or 16A	220...240VAC	1	0.251
PMA50 A415		380...415VAC	1	0.251
PMA50 A480		440...480VAC	1	0.251

General characteristics

- Pump protection relay against dry running, auxiliary AC power supply
- Motor under-load and over-current control
- Direct connection up to 16A max or by current transformer (CT)
- Excellent tripping accuracy
- Voltage control range 80...660VAC
- Current control range 0.1...16A
- Resetting and enabling consent input
- 1 relay output relay with 1 changeover contact (SPDT)
- Modular DIN 43880 housing, 3 module
- IEC degree of protection: IP40 on front (only when placed in IP40 enclosure or control board); IP20 at terminals.

ADJUSTMENTS

"Cosφ min"	Minimum cosφ threshold 0.1...0.99 (under-load/dry running)
"Imax"	Maximum (over) current threshold 10...100%I _e
"Trip delay"	Tripping time for minimum cosφ and maximum current 0.1...10s
"Inhibition time"	Inhibition delay for external input or at power up 1...60s
"Aut. reset delay"	Automatic reset time OFF...100min
"Mode"	<ul style="list-style-type: none"> • Rated current 5A or 16A • Single or three phase • External reset On or Off.

Certifications and compliance

Certifications obtained: EAC; UL Listed, for USA and Canada (cULus - File E93601), as Auxiliary Devices - Modular ampere monitoring relays.
Compliant with standards: IEC/EN 60255-5, IEC/EN 61000-6-2, IEC/EN 61000-6-3, UL 508, CSA C22.2 n° 14.

Operational diagram

See pages 18-23 and 24.

Phase shift monitoring relay for single and three-phase systems



PMA60...

Order code	Rated current I _e	Auxiliary supply voltage	Qty per pkg	Wt
	[A]	[V]	n°	[kg]
Single and three-phase systems. Minimum and maximum cosφ control. Delayed trip. AC auxiliary power supply. Automatic or manual reset.				
PMA60 A240	16A	220...240VAC	1	0.254
PMA60 A415		380...415VAC	1	0.254
PMA60 A480		440...480VAC	1	0.254

General characteristics

- Minimum and maximum phase shift monitoring relay, AC auxiliary power supply
- Direct connection up to 16A max or by current transformer (CT)
- Excellent tripping accuracy
- Voltage control range 80...660VAC
- Current control range 0.1...16A
- Automatic or manual resetting (manual resetting by power removal)
- 2 relay outputs (Min and Max), configurable, each with 1 changeover contact (SPDT)
- Modular DIN 43880 housing, 3 module
- IEC degree of protection: IP40 on front (only when placed in IP40 enclosure or control board); IP20 at terminals.

ADJUSTMENTS

- "Cosφ min" Minimum cosφ threshold
0.1...0.99 inductive
- "Trip delay" Tripping time for minimum cosφ
0.1...30s
- "Cosφ max" Maximum inductive cosφ threshold
0.1...0.99
- "Trip delay" Tripping time for maximum cosφ
0.1...30s
- "Inhibition time" Inhibition delay at power up 1...60s
- "Mode"
 - Single or three phase
 - Relay outputs normally energised or de-energised
 - Tripping memory (Latch) On or Off.

Certifications and compliance

Certifications obtained: EAC; UL Listed, for USA and Canada (cULus - File E93601), as Auxiliary Devices - Modular ampere monitoring relays.
Compliant with standards: IEC/EN 60255-5, IEC/EN 61000-6-2, IEC/EN 61000-6-3, UL 508, CSA C22.2 n° 14.

Operational diagram

See pages 18-24 and 25.

Frequency monitoring relay for single and three-phase systems



PMF20...

Order code	Rated voltage U _e	Qty per pkg	Wt
	[V] 50/60Hz	n°	[kg]
Single and three-phase systems. Minimum and maximum frequency. Delayed trip. Automatic reset.			
PMF20 A240	220...240VAC	1	0.125
PMF20 A415	380...415VAC	1	0.125

General characteristics

- Frequency monitoring relay, self powered, for minimum and maximum control
- Rated frequency selection: 50 or 60Hz
- Tripping threshold for minimum and maximum frequency
- Excellent tripping accuracy
- 1 relay output, configurable, with 1 changeover contact (SPDT)
- Modular DIN 43880 housing, 2 module
- IEC degree of protection: IP40 on front (only when placed in IP40 enclosure or control board); IP20 at terminals.

ADJUSTMENTS

- "Hz max" Maximum frequency tripping threshold
+1...+10%
- "Delay" Tripping time 0.1...20s
- "Hz min" Minimum frequency tripping threshold
-1...-10%
- "Delay" Tripping time 0.1...20s
- "Reset delay" Resetting time 0.1...20s
- "Mode"
 - Minimum and maximum frequency
 - Output relay energised at maximum frequency
 - Output relay energised at minimum frequency
 - Output relay de-energised at maximum frequency.

Certifications and compliance

Certifications obtained: EAC; UL Listed, for USA and Canada (cULus - File E93601), as Auxiliary Devices.
Compliant with standards: IEC/EN 60255-5, IEC/EN 61000-6-2, IEC/EN 61000-6-3, UL 508, BCSA C22.2 n° 14.

Operational diagram

See page 18-25.

For low voltage



PMVF 20...

Order code	Rated voltage		Qty per pkg	Wt
	Control	Auxiliary		
	[V]	[V]	n°	[kg]
PMVF 20	230VAC 400VAC	100...400VAC/ 110...250VDC	1	0.568
PMVF 20 D048		12...48VDC	1	0.580

Three-phase system, with or without neutral, in low voltage. Dual threshold minimum and maximum voltage and frequency protection. Flush mount type.

Voltage threshold per CEI 0-21

Type of protection	Tripping threshold	Tripping time
Maximum voltage 59.S2	1.15Un	0.2s
Maximum voltage 59.S1 (moving mean over 10min)	1.10Un	≤ 3s
Minimum voltage 27.S1	0.85Un	0.4s
Minimum voltage 27.S2	0.4Un	0.2s

Frequency threshold per CEI 0-21

Type of protection	Tripping threshold	Tripping time
High external signal and low local control conditions.		
Maximum frequency 81>.S2	51.5Hz	0.1s
Minimum frequency 81<.S2	47.5Hz	0.1s
Low external signal and high local control conditions.		
Maximum frequency 81>.S2	51.5Hz	1s
Minimum frequency 81<.S2	47.5Hz	4s
High conditions for both external signal and local control.		
Maximum frequency 81>.S1	50.5Hz	0.1s
Minimum frequency 81<.S1	49.5Hz	0.1s

NOTE: Low conditions for both external signal and local control are not taken into consideration by the standard.

Order code	Description

EXPANSION MODULES FOR PMVF 20.

For independent signal in case of phase power unbalance (LSP).

EXP10 03	2 relay outputs 5A 250VAC
Communication ports.	
EXP10 18	IEC/EN 61850 interface
EXP10 10	Opto-isolated USB interface
EXP10 11	Opto-isolated RS232 interface
EXP10 12	Opto-isolated RS485 interface
EXP10 13	Opto-isolated Ethernet interface

IEC/EN 61850 protocol

The EXP10 18 module will be made available only when the competent authorities have established the exact terms of the supervision and control of the specific commands (currently under study as specified in the Italian CEI 0-21 standard).

General characteristics

PMVF 20 interface protection system (SPI) unit has been developed according to the Italian CEI 0-21 standard prescriptions. It is used when a local generating system is connected in parallel with the low-voltage electric utility. The controls refer to limits of voltage and frequency monitoring.

In the case when either the voltage or the frequency are out of admissible limits, the SPI must step in by de-energising a relay output so that the interface device (DDI) trips.

PMVF 20 is equipped with 4 inputs having the following functions:

- DDI status feedback
- External signal for frequency selection (communication network malfunction)
- Local control for frequency selection
- Remote tripping (forced DDI opening independent of voltage and frequency values).

Also, there are two relay outputs for:

- DDI opening and closing
- Standby device opening (programmable: retentive normally energised, retentive normally de-energised or adjustable pulse).

The standby device control is compulsory in installations with more than 20kW and consists of a signal, with a 0.5s delay respect to the DDI opening command, transmitted only if the DDI fails and does not complete the disconnection.

By fitting the EXP10 03 expansion module on the PMVF 20, the following functions can be configured as:

- Programmable alarm
- Autonomous signalling in case of phase power unbalance (LSP), only if three CTs are also installed.

Operational characteristics

- Auxiliary voltage:
 - PMVF 20: 100...400VAC/110...250VDC
 - PMVF 20 D048: 12...48VDC
- Voltage inputs:
 - 400VAC (three-phase connection)
 - 230VAC (single-phase connection)
- Relay outputs 5A 250VAC AC1 / 5A 30VDC
- 4 digital inputs
- Current inputs (optional): Use via CTs with selectable /5A or /1A secondary
- Support of EXP series communications ports (USB, RS232, RS485, Ethernet) see section 28
- Parameter configuration and remote control (only with communication expansion module) with software **Synergy** and **Xpress**
- Housing: Flush mount 96x96mm/3.78x3.78"
- IEC degree of protection: IP65 on front; IP20 on terminals
- **Predisposed for IEC/EN 61850 signal supervision using expansion or external module.**

Reference standards

Compliant with standards: Italian CEI 0-21, IEC/EN 60255-5, IEC/EN 61010-1, IEC/EN 61000-6-2, IEC/EN 61000-6-3.

Note for Italian CEI 0-21 standard:

According to standard prescriptions, once the installation is completed, the interface protection must be tested by the installer using a relay test box which controls the trip thresholds and timing.

Operational diagram

See page 18-26.

Programming software

Since PMVF 20 is standard-supplied pre-programmed, with specific default settings as per the Italian standard CEI 0-21, it can be put in service immediately without having to change any programming. Setup editing is password protected so that parameter settings cannot be tampered with by unauthorised personnel.

Supervision and energy management **Synergy** software

See section 27.

Configuration and remote control software **Xpress**

See section 27.



EXP10 03

For low voltage



PMVF 51

Order code	Rated voltage		Qty per pkg	Wt
	Control	Auxiliary		
	[V]	[V]	n°	[kg]
Three-phase system with or without neutral in low voltage. Dual threshold minimum and maximum voltage and frequency protection. Modular type with 2 relay outputs.				
PMVF 51	230VAC 400VAC	100...240VAC/ 110...250VDC	1	0.470

Voltage threshold per CEI 0-21

Type of protection	Tripping threshold	Tripping time
Maximum voltage 59.S2	1.15Un	0.2s
Maximum voltage 59.S1 (moving mean over 10min)	1.10Un	≤ 3s
Minimum voltage 27.S1	0.85Un	0.4s
Minimum voltage 27.S2	0.4Un	0.2s

Frequency threshold per CEI 0-21

Type of protection	Tripping threshold	Tripping time
High external signal and low local control conditions.		
Maximum frequency 81>.S2	51.5Hz	0.1s
Maximum frequency 81<.S2	47.5Hz	0.1s
Low external signal and high local control conditions.		
Maximum frequency 81>.S2	51.5Hz	1s
Minimum frequency 81<.S2	47.5Hz	4s
High conditions for both external signal and local control.		
Maximum frequency 81>.S1	50.5Hz	0.1s
Minimum frequency 81<.S1	49.5Hz	0.1s

NOTE: Low conditions for both external signal and local control are not taken into consideration by the standard.

Order code	Description
EXPANSION MODULES FOR PMVF 51. Communication ports.	
EXM10 10	Opto-isolated USB interface
EXM10 11	Opto-isolated RS232 interface
EXM10 12	Opto-isolated RS485 interface
EXM10 13	Opto-isolated Ethernet interface
EXM10 18	IEC/EN 61850 interface
Inputs and outputs.	
EXM10 01	2 digital opto-isolated inputs and 2 relay outputs 5A 250VAC

IEC/EN 61850 protocol

The EXM10 18 module will be made available only when the competent authorities have established the exact terms of the supervision and control of the specific commands (currently under study as specified in the Italian CEI 0-21 standard).



EXM10...

General characteristics

PMVF 51 interface protection system (SPI) unit has been developed according to the Italian CEI 0-21 standard prescriptions. Each is used when a local solar generating system is connected in parallel with the low-voltage electric utility. The controls refer to limits of voltage and frequency monitoring.

In the case when either the voltage or the frequency are out of admissible limits, the SPI must step in by de-energising a relay output so that the interface device (DDI) trips.

PMVF 51 is equipped with 4 inputs having the following functions:

- DDI status feedback
- External signal for frequency selection (communication network malfunction)
- Local control for frequency selection
- Remote tripping (forced DDI opening, independent of voltage and frequency values).

Also, there are two relay outputs for:

- DDI opening and closing
- Standby device opening (programmable: retentive normally energised, retentive normally de-energised or adjustable pulse).

The standby device control is compulsory in installations with more than 20kW and consists of a signal, with a 0.5s delay respect to the DDI opening command, transmitted only if the DDI failed and did not complete the disconnection.

PMVF 51 also has two additional relay outputs to configure as:

- Programmable alarm
- Autonomous signalling in case of phase power unbalance (LSP), only if three CTs are also installed.

Operational characteristics

- Auxiliary voltage: 100...240VAC/110...250VDC
- Voltage inputs:
 - 400VAC (three-phase connection)
 - 230VAC (single-phase connection)
- Relay outputs 5A 250VAC AC1 / 5A 30VDC
- 4 digital inputs
- Current inputs (optional): Use via CTs with selectable /5A or /1A secondary
- Support of EXM series communications inputs (USB, RS232, RS485, Ethernet) see section 28
- Modular housing:
 - PMVF 51: 6 module
- Parameter configuration and remote control (only with communication expansion module) with software **Synergy** and **Xpress**
- Degree of protection for both: IP40 on front; IP20 on terminals
- **Predisposed for IEC/EN 61850 signal supervision using expansion or external module.**

Reference standards

Compliant with standards: Italian CEI 0-21, IEC/EN 60255-5, IEC/EN 61010-1, IEC/EN 61000-6-2, IEC/EN 61000-6-3.

Note for Italian CEI 0-21 standard:

According to standard prescriptions, once the installation is completed, the interface protection must be tested by the installer using a relay test box which controls the trip thresholds and timing.

Operational diagram

See pages 18-27.

Programming software

Since PMVF 51 is standard-supplied pre-programmed, with specific default factory settings as per the Italian standard CEI 0-21, it can be put in service immediately without having to change any programming. Setup editing is password protected so that parameter settings cannot be tampered with by unauthorised personnel.

Supervision and energy management **Synergy software**
See section 27.

Configuration and remote control software **Xpress**
See section 27.

For medium voltage



PMVF 30...

Voltage threshold per CEI 0-16

Order code	Rated voltage		Qty per pkg	Wt [kg]
	Control [V]	Auxiliary [V]		
	[V]	[V]	n°	[kg]
Medium-voltage system. Dual threshold minimum and maximum voltage and frequency protection. Flush mount type.				
PMVF 30	Measurements via VTs in MV or direct in LV	100...400VAC/ 110...250VDC	1	0.566
PMVF 30 D048		12...48VDC	1	0.566

Type of protection	Tripping threshold	Tripping time
Maximum voltage 59.S2	1.2Un	0.6s
Maximum voltage 59.S1 (moving mean over 10min)	1.1Un	≤ 3s
Minimum voltage 27.S1	0.85Un	0.4s
Minimum voltage 27.S2	0.4Un	0.2s
Maximum residual voltage 59.V0 (59N)	5% √3 Un	25s

Frequency threshold per CEI 0-16
Frequency protection at voltage choice

Type of protection	Tripping threshold	Tripping time
Configuration in standard conditions.		
Maximum frequency 81>.S2	51.5Hz	1s
Minimum frequency 81<.S2	47.5Hz	4s
Limited configuration in case of local control or voltage choice condition		
Maximum frequency 81>.S1	50.2Hz	0.15s
Minimum frequency 81<.S1	49.8Hz	0.15s
– Voltage choice functions		
Maximum residual voltage 59.V0 (59N)	5% √3 Un	-
Minimum direct sequence voltage 27.Vd	70% Un	-
Maximum inverse sequence voltage 59.Vi	15% Un	-

Order code	Description
EXPANSION MODULES FOR PMVF 30. For auto reclosing management of automatic circuit breaker (DDI).	
EXP10 03	2 relay outputs 5A 250VAC
Communication ports.	
EXP10 18	IEC/EN 61850 interface
EXP10 10	Opto-isolated USB interface
EXP10 11	Opto-isolated RS232 interface
EXP10 12	Opto-isolated RS485 interface
EXP10 13	Opto-isolated Ethernet interface

IEC/EN 61850 protocol

The EXP10 18 module will be made available only when the competent authorities have established the exact terms of the supervision and control of the specific commands (currently under study as specified in the Italian CEI 0-16 standard).

18



EXP10...

General characteristics

PMVF 30 interface protection system (PI) unit has been developed according to the Italian CEI 0-16 standard prescriptions. It is used when a local generating system is connected in parallel with the medium-voltage utility distribution grid. The controls refer to limits of voltage and frequency monitoring.

In the case when either the voltage or the frequency are out of admissible limits, the SPI must step in by de-energising a relay output so that the interface device (DDI) trips.

PMVF 30 is equipped with inputs having the following functions:

- DDI status feedback
- Interface protection system exclusion
- Local control
- Remote tripping (forced DDI opening, independent of voltage and frequency values).

In addition, there are two relay outputs to configure as:

- DDI opening
- Programmable (either as factory default for standby device opening or to set up as auto reclosing if the DDI is an automatic circuit breaker).

Standby device opening

In installations with more than 400kW, the standard specifies there must be a command signal, that releases another standby device, given within 1 second whenever the DDI opening fails or malfunctions.

Automatic DDI reclosing

Whenever an automatic circuit breaker is used as the DDI, the PMVF 30 is capable of controlling both the opening (according to the installation conditions indicated in the Italian CEI 0-16 standard) and the auto reclosing. The auto reclosing function includes defining the number of attempts and the time interval between an attempt and the following one as well as generating an alarm if the closing operation does not take place. This function can be carried out through a programmable output of the PMVF 30 (unless it is already used for the standby device operation) or by installing an EXP10 03 expansion module.

Operational characteristics

- Auxiliary voltage:
 - PMVF 30: 100...400VAC/110...250VDC
 - PMVF 30 D048: 12...48VDC
- Voltage inputs (connection via VTs in MV or directly in LV end):
 - Primary: 400...150,000V
 - Secondary: 50...500V (for voltage/frequency); 50...150V (for residual voltage measurement)
- Relay outputs 5A 250VAC AC1 / 5A 30VDC
- 4 digital inputs
- 3 current inputs (for optional measuring): Use via CTs with selectable /5A or /1A secondary
- Support of EXP series communications ports (USB, RS232, RS485, Ethernet); see section 28
- Housing: Flush mount 96x96mm/3.78x3.78"
- Parameter configuration and remote control (only with communication expansion module) with software **Synergy** and **Xpress**
- Degree of protection: IP65 on front; IP20 on terminals
- **Predisposed for IEC/EN 61850 signal supervision using expansion or external module.**

Reference standards

Compliant with standards: Italian CEI 0-16; IEC/EN 60255-5, IEC/EN 61010-1, IEC/EN 61000-6-2, IEC/EN 61000-6-3.

Operational diagram

See page 18-28.

Programming software

Since PMVF 30 is standard-supplied pre-programmed, with specific default factory settings as per the Italian standard CEI 0-16, it can be put in service immediately without having to change any programming. Setup editing is password protected so that parameter settings cannot be tampered with by unauthorised personnel.

Supervision and energy management **Synergy** software

See section 27.

Configuration and remote control software **Xpress**

See section 27.

GSM modem for remote disconnection signal management

Compliant with Italian CEI 0-16 Standard, paragraph 8.8.6.5 and annex M, resolution 421/2014 of the AEEGSI



PMVF GSM 1

Order code	Description
	GSM Modem (modular - 4U). IP69K exterior aerial with 2.5 m cable. RJ45-USB programming cable (included).
PMVF GSM 1	9.5...35VDC/9.5...27VAC

green LED: output status
Off: exit de-energised
On: exit energised

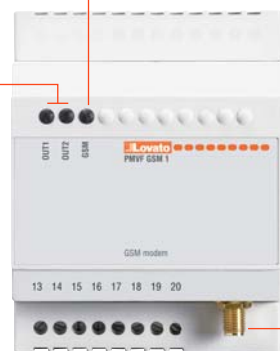

RJ45 connector for programming

blue LED: GSM status

Off: not supplied

On constantly: not registered on the network (wrong or missing PIN)

Flashing slowly: network registration OK

Flashing quickly: communication in progress

Aerial connector

Software

To configure the PMVF GSM 1 modem (using the RJ45-USB programming cable included), the PMVF GSM SW software must be used. This can be downloaded freely from the www.LovatoElectric.com website.

The software allows you to set:

- the users enabled to exchange messages with the modem
- the active customer code (POD)
- the functions assigned to the digital outputs and input
- the texts of the SMS associated with the commands.

Configuration is also possible off-line, creating a file to transfer to the modem at another time.

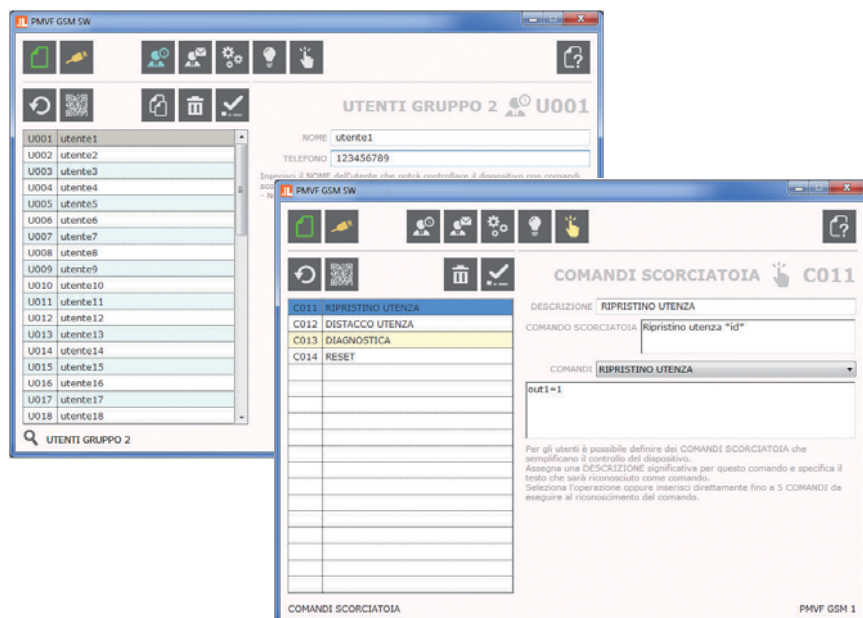

Application requirements

The Italian CEI 0-16 Standard, in paragraph 8.8.6.5 and annex M, prescribes that electricity production systems powered by wind or the sun through photovoltaics with a power equal to or greater than 100kW, connected to or to be connected to medium-voltage networks, have a GSM modem.

The modem must be able to receive the signals sent by the electricity distributor for the management of generation disconnection.

Functional characteristics

- Connection to the GSM network for sending and receiving SMS messages
- Programmable message texts
- Control output controlled by SMS for sending of intertripping signal to the protection interface
- Digital input for receiving the status of the Interface Device (DDI) and sending of successful DDI opening and closing SMSs
- POD management (active user code)
- Management of the list of caller IDs (CLI) up to 50 callers enabled
- Detection of mobile network coverage
- Full compatibility with medium-voltage PI LOVATO Electric PMVF 30: no software/hardware updates or programming required
- Compatibility with third-party PIs where the remote disconnection signal is transmitted via digital input (dry contact). For additional information contact our Customer Service office Tel. + 39 035 4282422; E-mail: service@LovatoElectric.com.

Operational characteristics

MODEM

- 35mm DIN (IEC/EN 60715) rail fixing
- 4 modules
- Supply: 9.5...35VDC / 9.5...27VAC
- Consumption: 200mW (5W peak)
- 2 digital outputs 3A 250VAC
- 1 self-supplied digital input
- Housing for 3V and 1.8V SIM card
- SIM PIN management
- Certified according to FCC rules, part 15
- Back-up battery 320mAh (3.7 V)
- Operating temperature: 0...+45°C; -30...+60°C with back-up battery disconnected (for disconnection procedure consult the manual supplied with the product)
- Protection rating: IP40 on front; IP20 on terminals.

AERIAL

- Quad band 850/900/1800/1900MHz
- Exterior IP69K
- 2.5m cable
- Fixing via M10 hole:
 - with adhesive seal
 - with threaded pin and nut.

Compliance

Compliant with standards: IEC/EN 60950-1 (≤2013-05); EN 50385; EN 301 489-7 V1.3.1; EN 301 489-1 V1.9.2; EN 301 511 V9.0.2

Maximum combination for PMVF 20 and PMVF 30 types

In addition to the two standard-supplied modules, another two expansion modules (one per type) can be installed from the following indicated below.

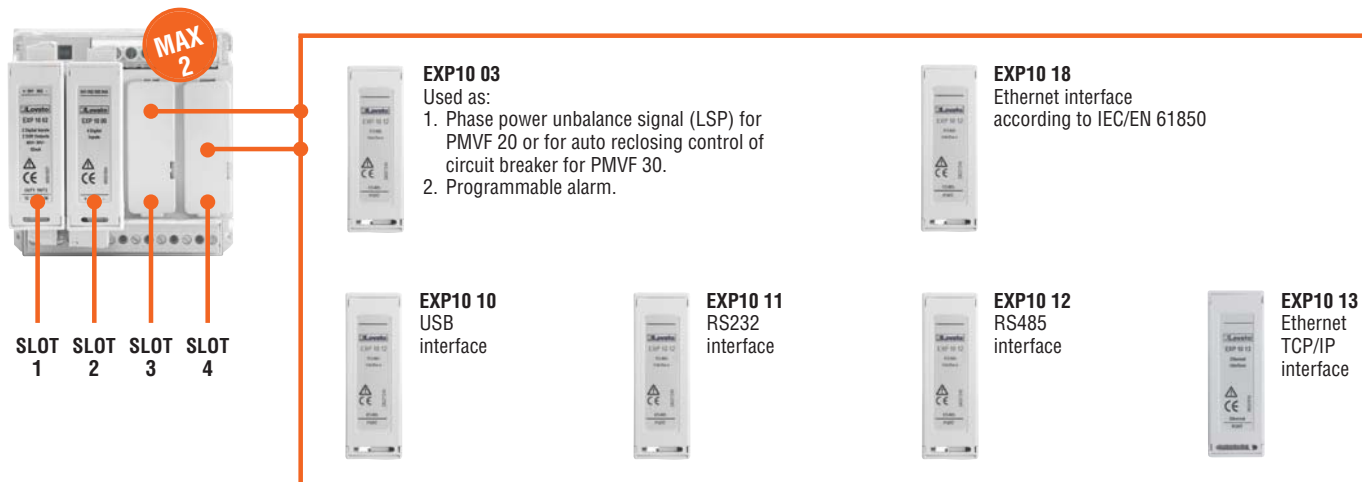

Maximum combination for PMVF 51 type

In addition to the standard-supplied module (1), two other expansion modules (one per type) can be installed from the indicated types.

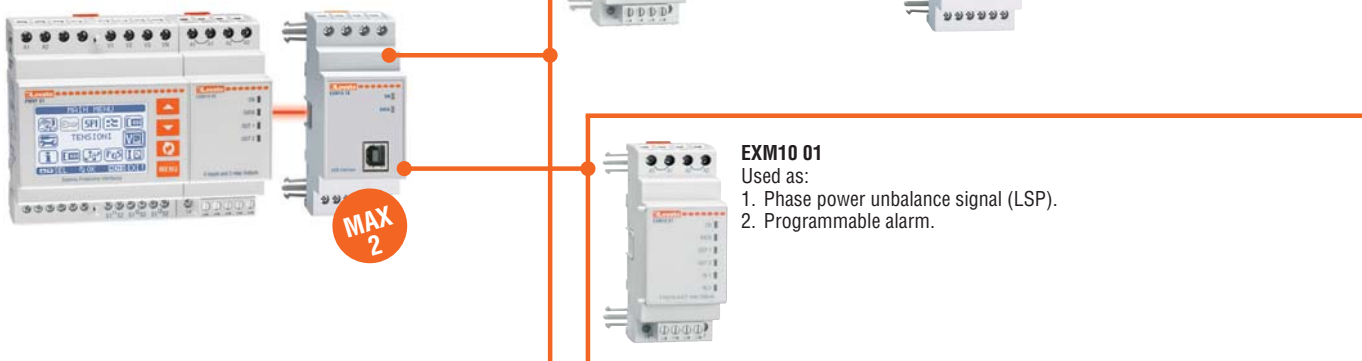

PROTECTION RELAYS PMV10...

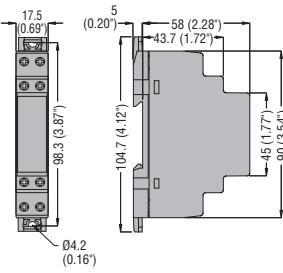

PMV... - PMF20 PMA20... - PMA30...

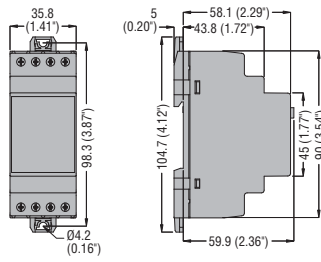

PMV...N - PMA40... - PMA50... - PMA60...

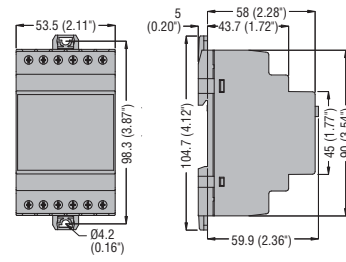

INTERFACE PROTECTION SYSTEM UNITS FOR LOW VOLTAGE PMVF 20...

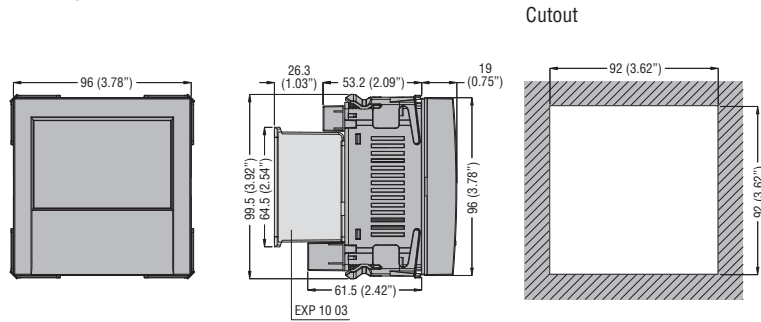

PMVF 51

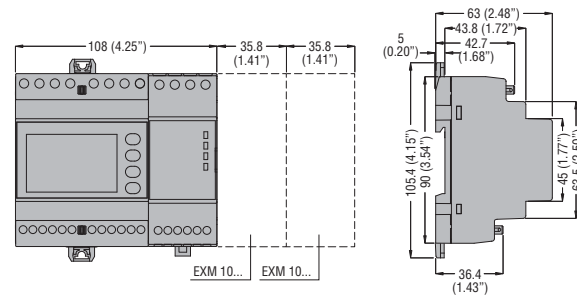

INTERFACE PROTECTION SYSTEM UNIT FOR MEDIUM VOLTAGE PMVF 30

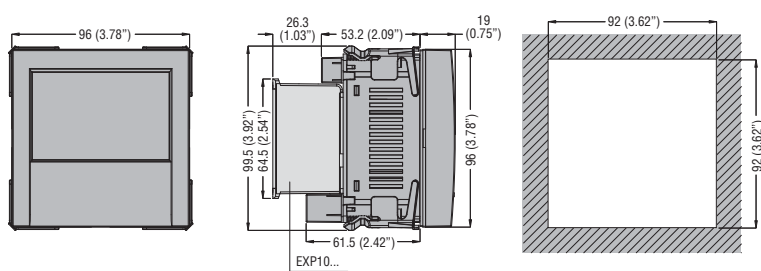

GSM MODEM FOR REMOTE DISCONNECTION SIGNAL PMVF GMS 1

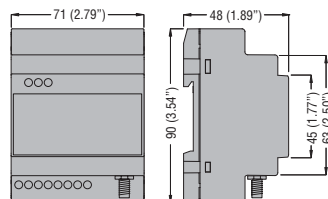

Voltage monitoring relays for 3-phase systems without neutral

PMV10 - PMV20 - PMV30 - PMV40
PMV50 - PMV70

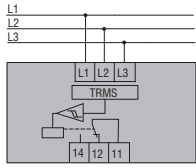

Phase loss and incorrect phase sequence (PMV10 - PMV20 - PMV30 - PMV40 - PMV50 - PMV70)

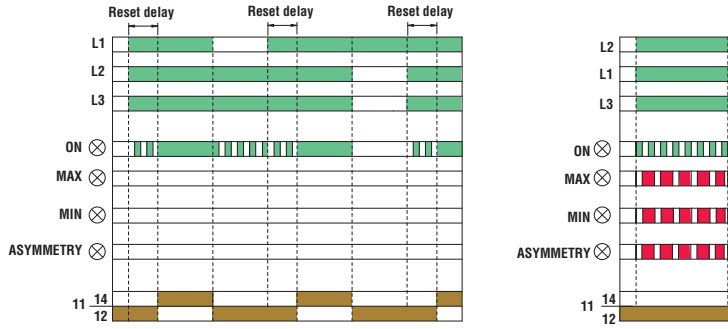

Maximum and minimum voltage (PMV30 - PMV50 - PMV70)

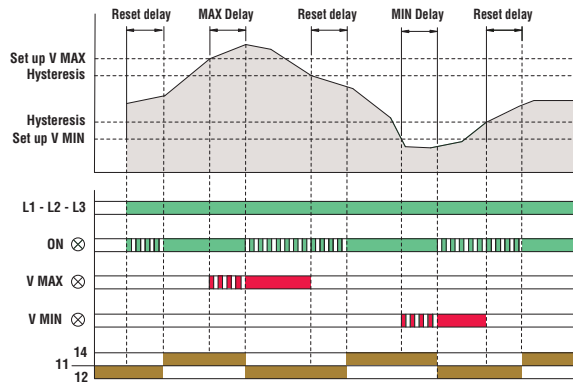

Asymmetry (PMV40 - PMV70)

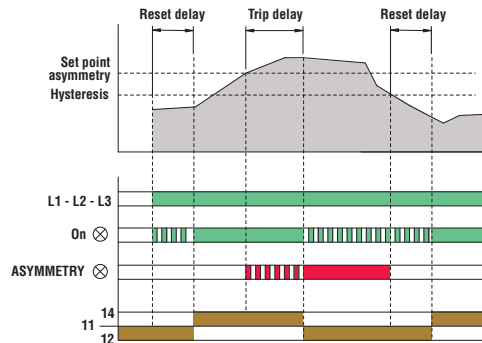

Voltage monitoring relays for 3-phase systems c/w or w/o neutral PMV50N - PMV70N - PMV80N

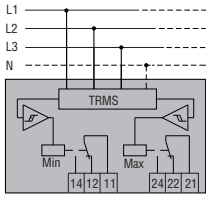

Phase loss and incorrect phase sequence (PMV50N - PMV70N - PMV80N)

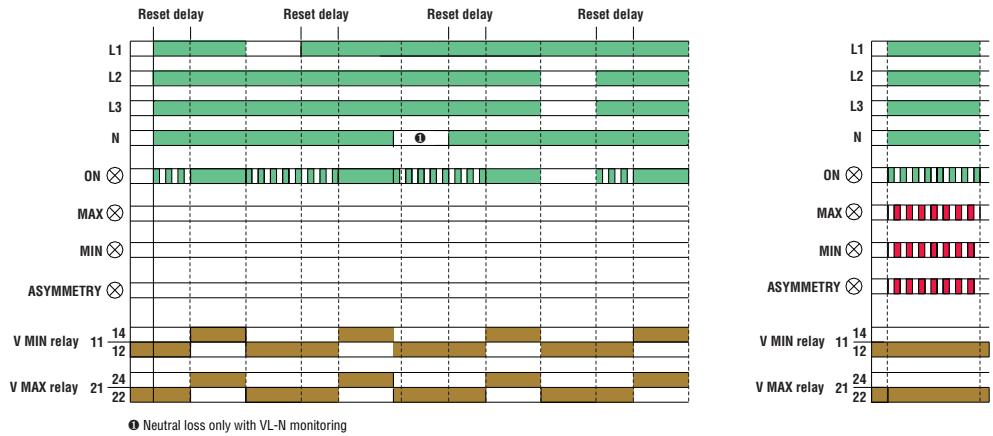

Maximum and minimum voltage (PMV50N - PMV70N - PMV80N)

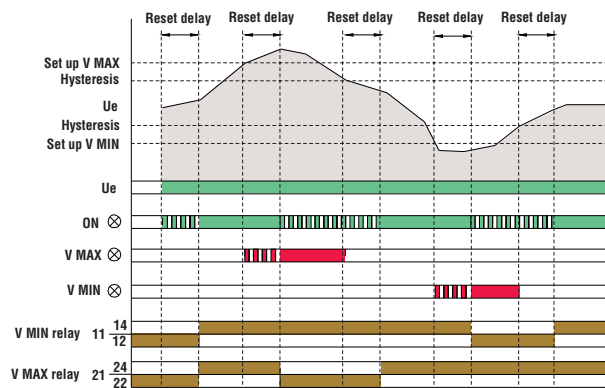

Asymmetry (PMV70N)

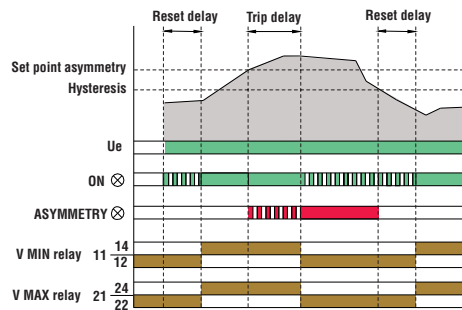

Maximum and minimum frequency (PMV80N)

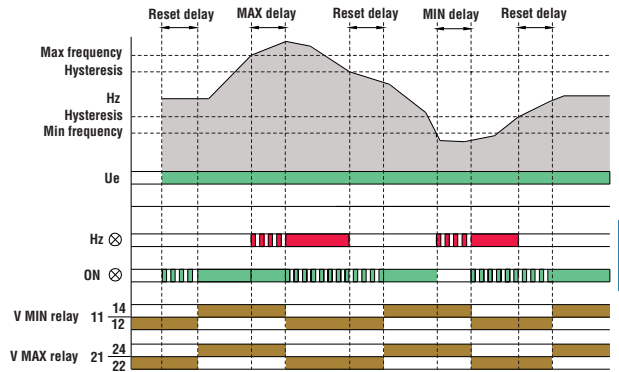

Voltage monitoring relay for 1-phase systems

PMV55

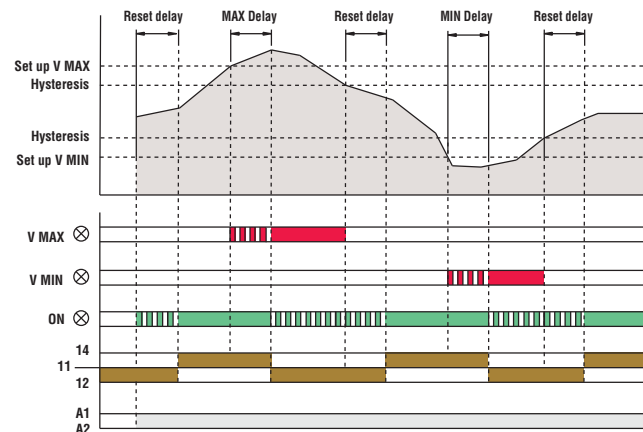
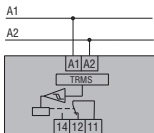

Current monitoring relay for 1-phase systems PMA20

Single-phase connection with CT

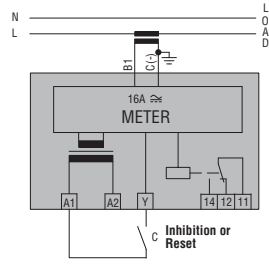

Single-phase direct connection

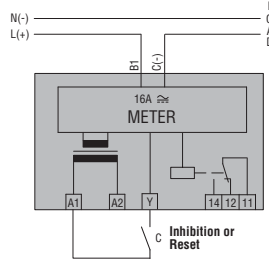

Operation with tripping latch (Latch ON)

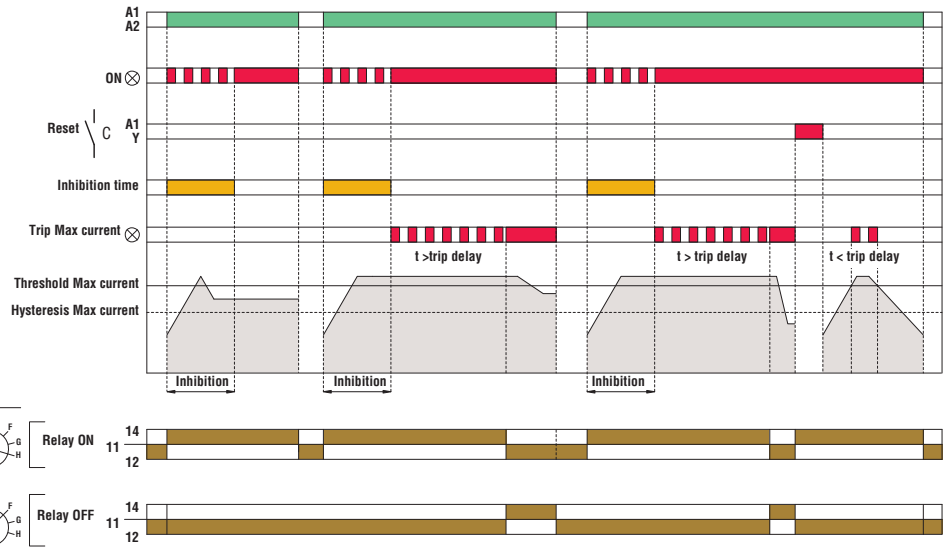

Operation with no tripping latch (Latch OFF)

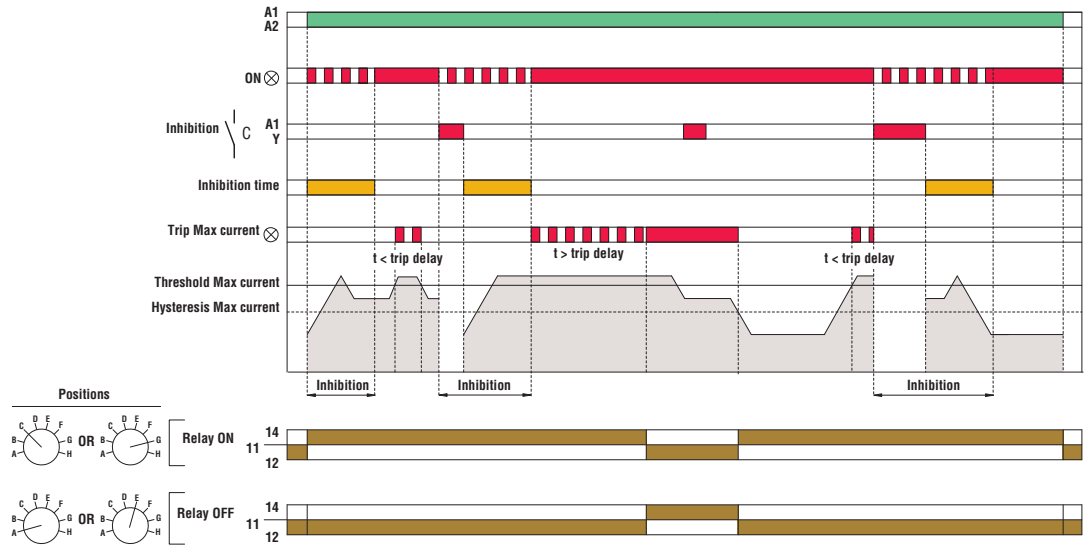

Operation			
Mode	Ie	Relay output	Latch
A	5A	OFF	OFF
B		ON	ON
C		OFF	OFF
D		ON	ON
E	16A	OFF	OFF
F		ON	ON
G		OFF	OFF
H		ON	ON

Current monitoring relay for single and three-phase systems

PMA30

Single-phase connection by CT

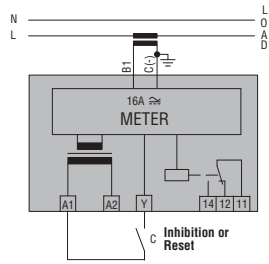

Single-phase direct connection

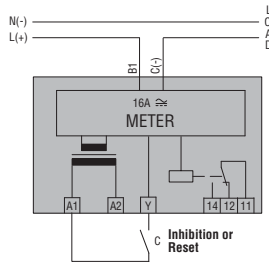

Three-phase connection by CT (1 phase control)

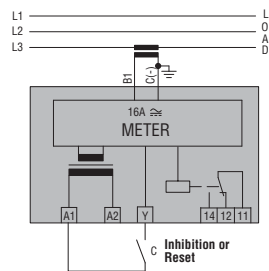

Three-phase direct connection (1 phase control)

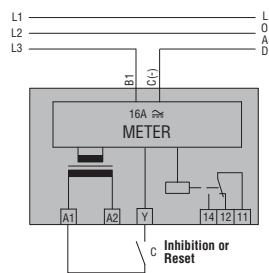

Operation			
Mode	Function	Relay output	Latch
A	Minimum current	OFF	OFF
B		ON	ON
C		ON	OFF
D	Maximum current	OFF	ON
E		OFF	OFF
F		ON	ON
G		ON	OFF
H		ON	ON

Maximum current control operation with tripping latch (Latch ON)

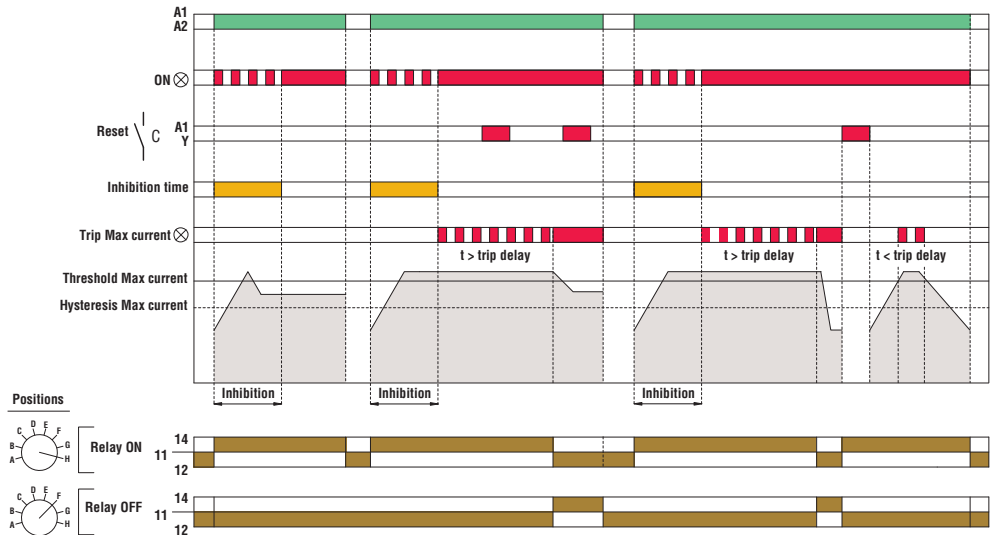

Maximum current control operation with no tripping latch (Latch OFF)

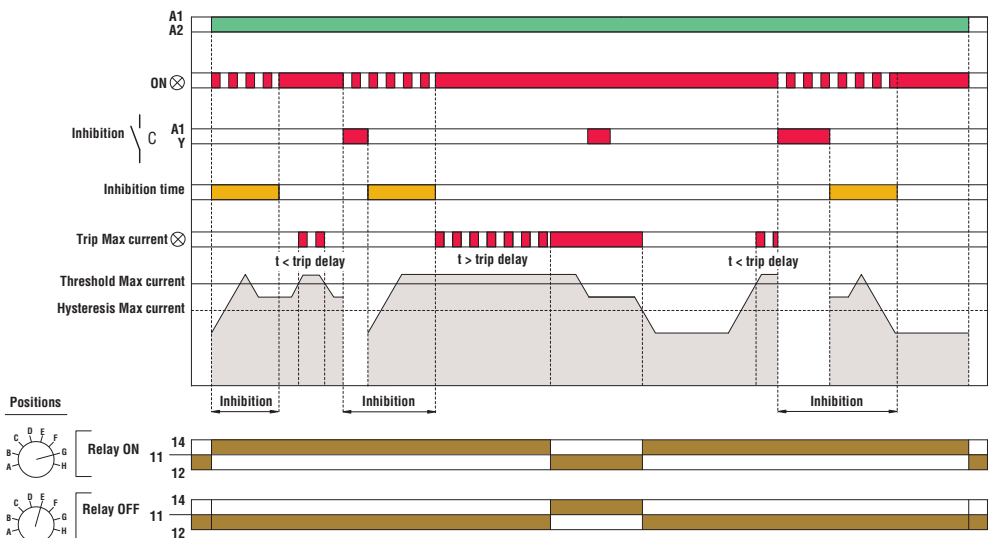

Minimum current control operation with tripping latch (Latch ON)

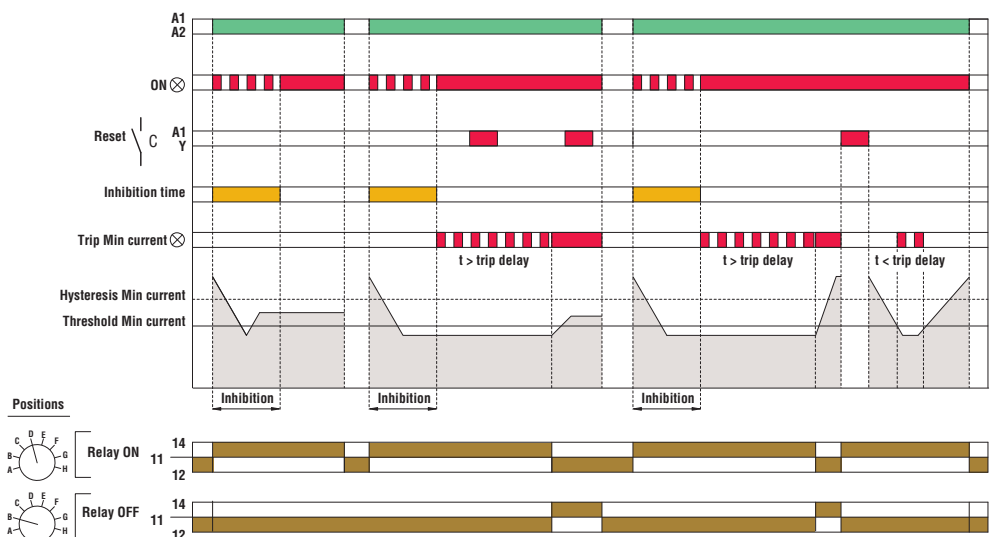

Minimum current control operation with no tripping latch (Latch OFF)

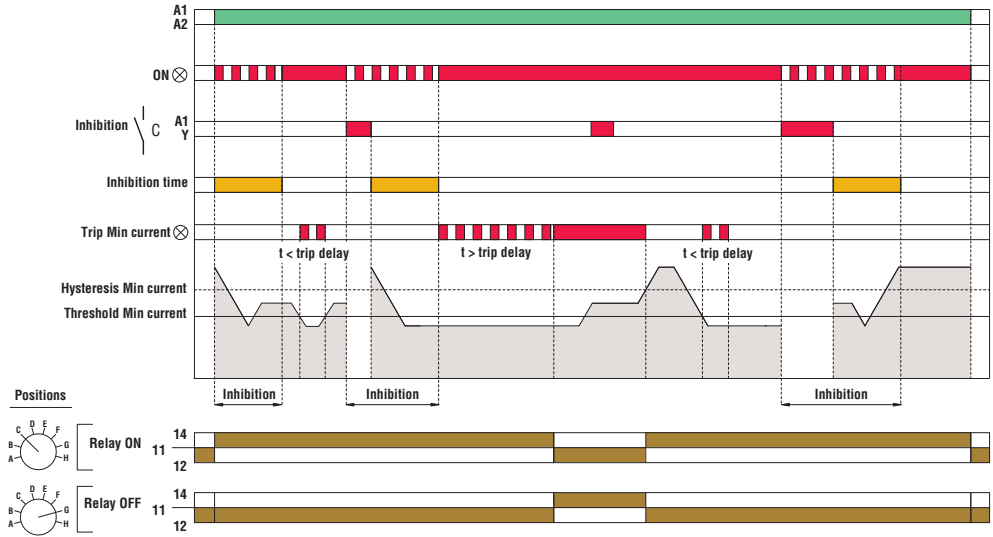

Current monitoring relay for single and three-phase systems

PMA40

Single-phase connection by CT

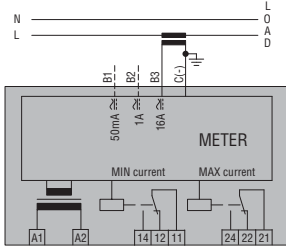

Single-phase direct connection

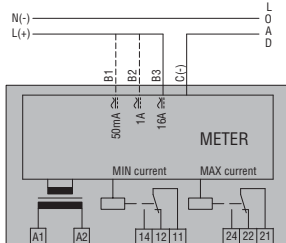

Three-phase connection by CT (1 phase control)

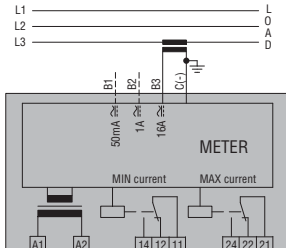

Operation with tripping latch (Latch ON)

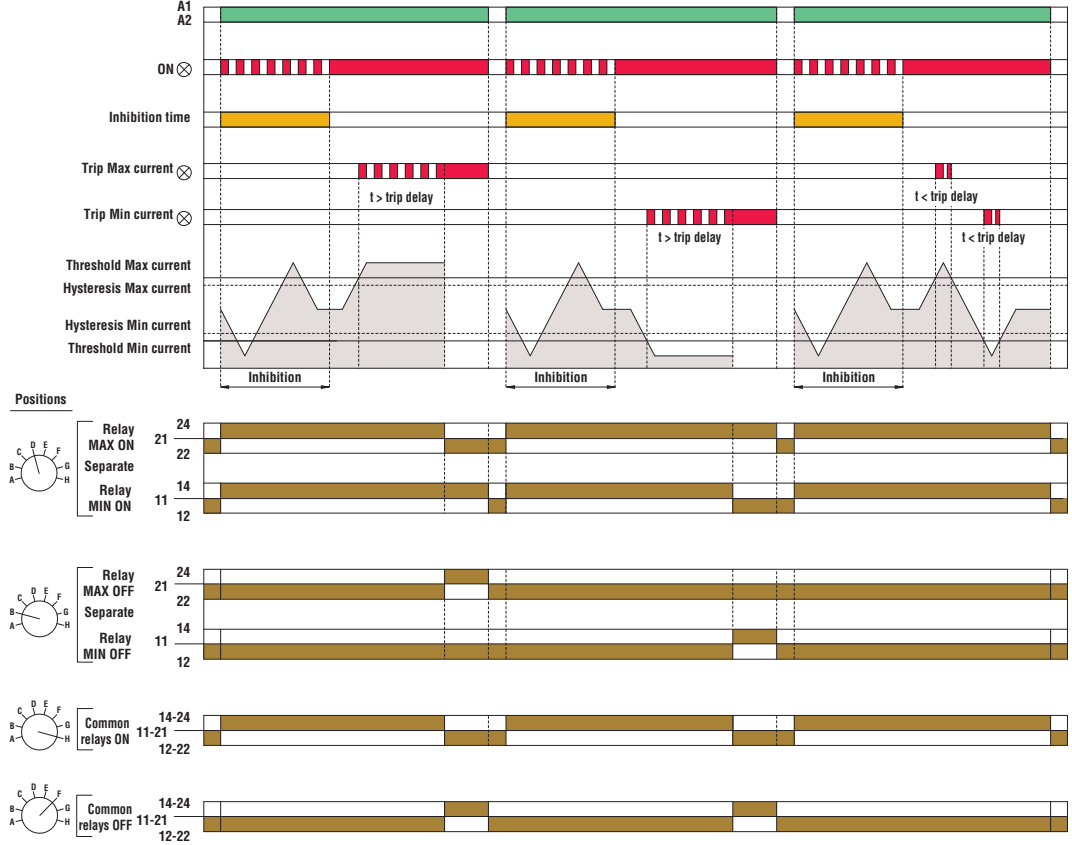

Three-phase direct connection (1 phase control)

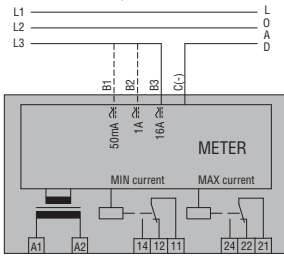

Operation			
Mode	Operation	Relay output	Latch
A	Separate relays	OFF	OFF
B		ON	ON
C		OFF	OFF
D	Common relays	ON	ON
E		OFF	OFF
F		ON	ON
G		OFF	OFF
H		ON	ON

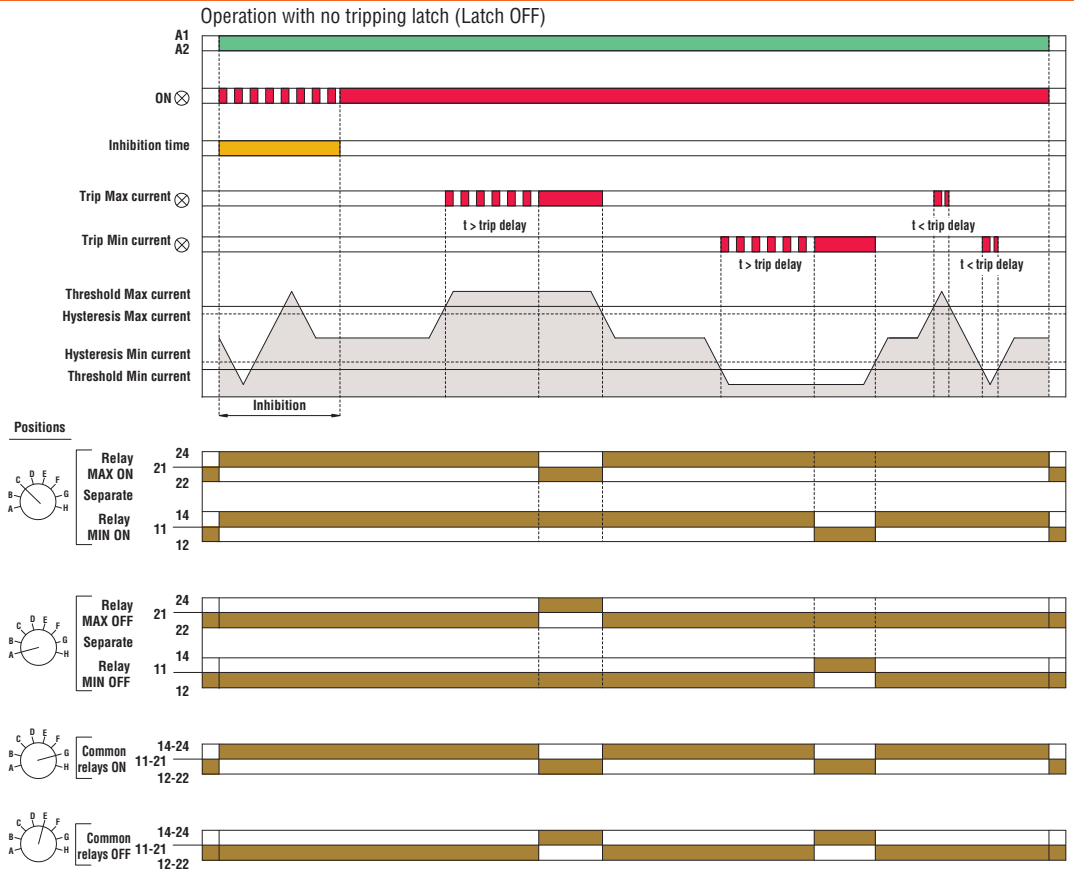

Pump protection - motor under-load/over-current monitoring PMA50

Three-phase connection by CT

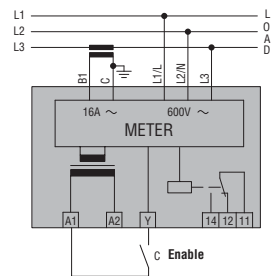

Three-phase direct connection

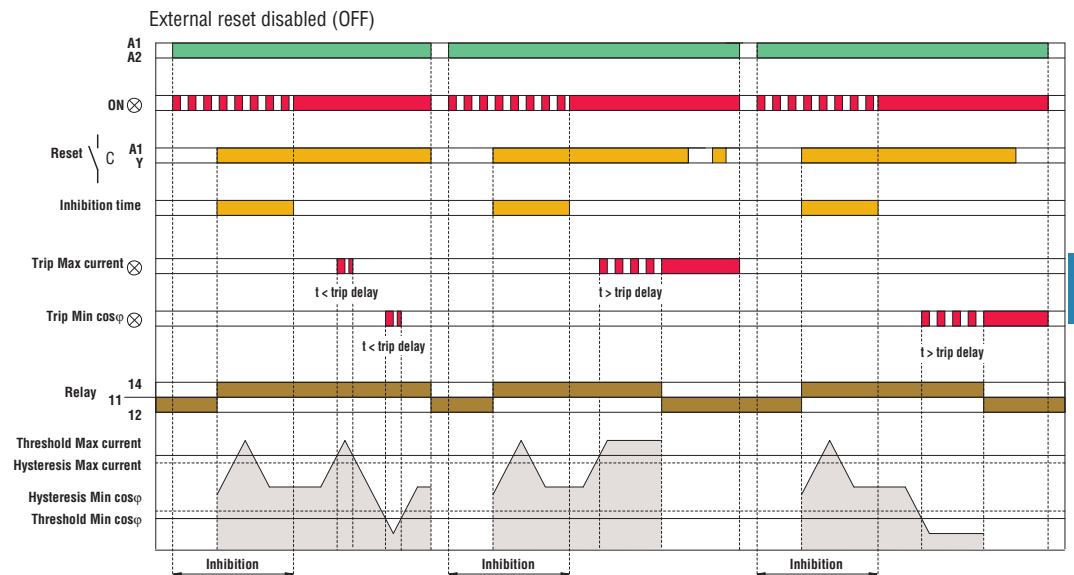
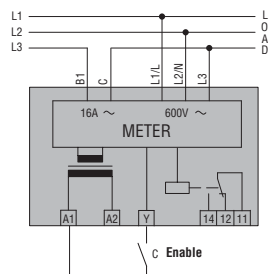

Single-phase connection by CT

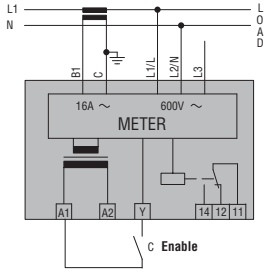

Operation			
Mode	Ie	Connection	External reset
A	5A	1 phase	OFF
B		ON	
C		3 phase	OFF
D	16A	1 phase	ON
E		OFF	
F		ON	
G		3 phase	OFF
H			ON

External reset enabled (ON)

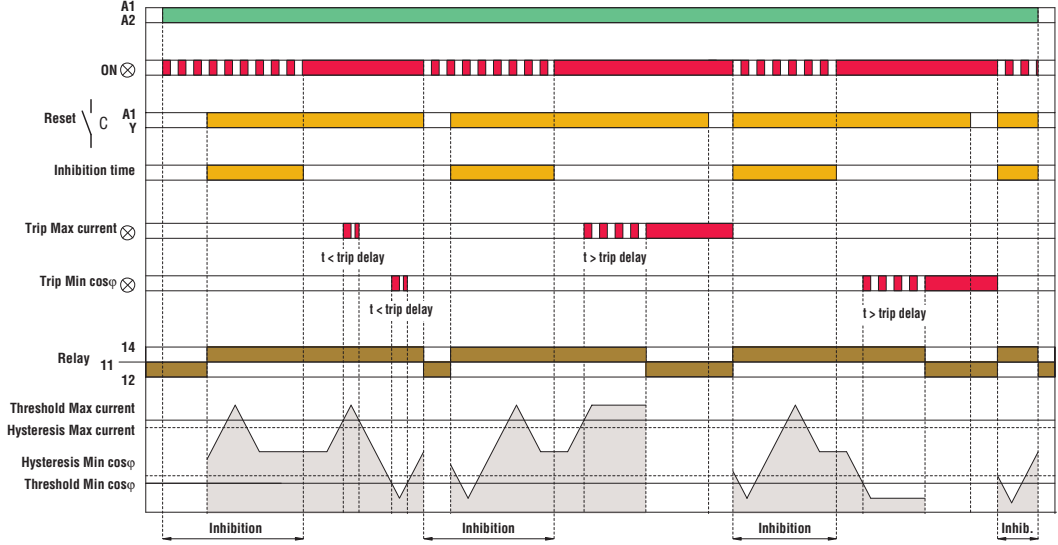

Phase shift monitoring relay

PMA60

Three-phase connection by CT

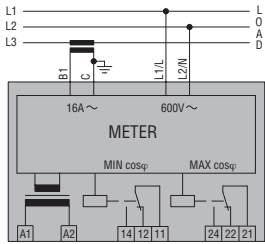

Three-phase direct connection

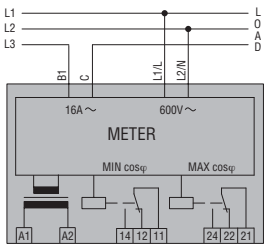

Operation with tripping latch (Latch ON)

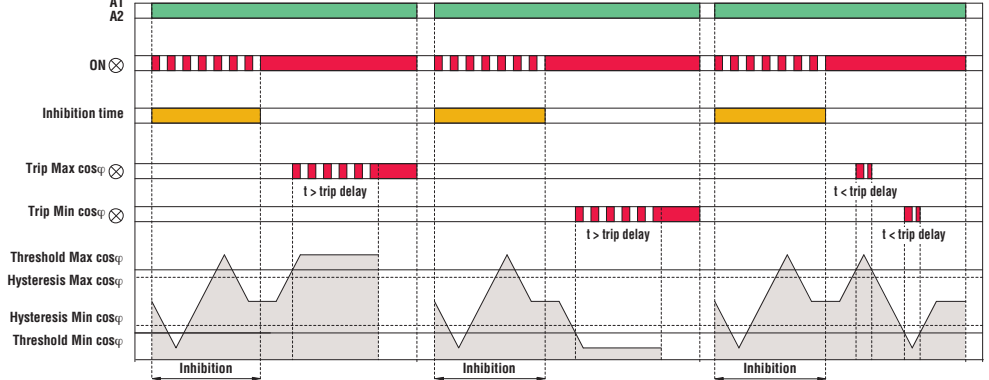

Positions

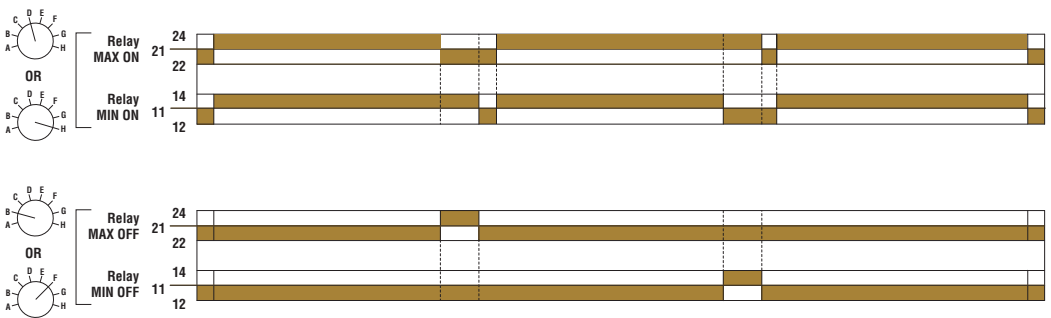

Single-phase connection by CT

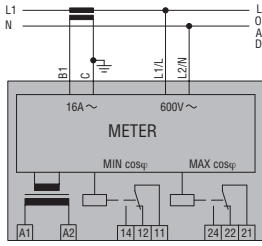

Operation			
Mode	Connection	Relay output	Latch
A	1 phase	OFF	OFF
B		ON	ON
C		ON	OFF
D		ON	ON
E	3 phase	OFF	OFF
F		ON	ON
G		OFF	OFF
H		ON	ON

Operation with no tripping latch (Latch OFF)

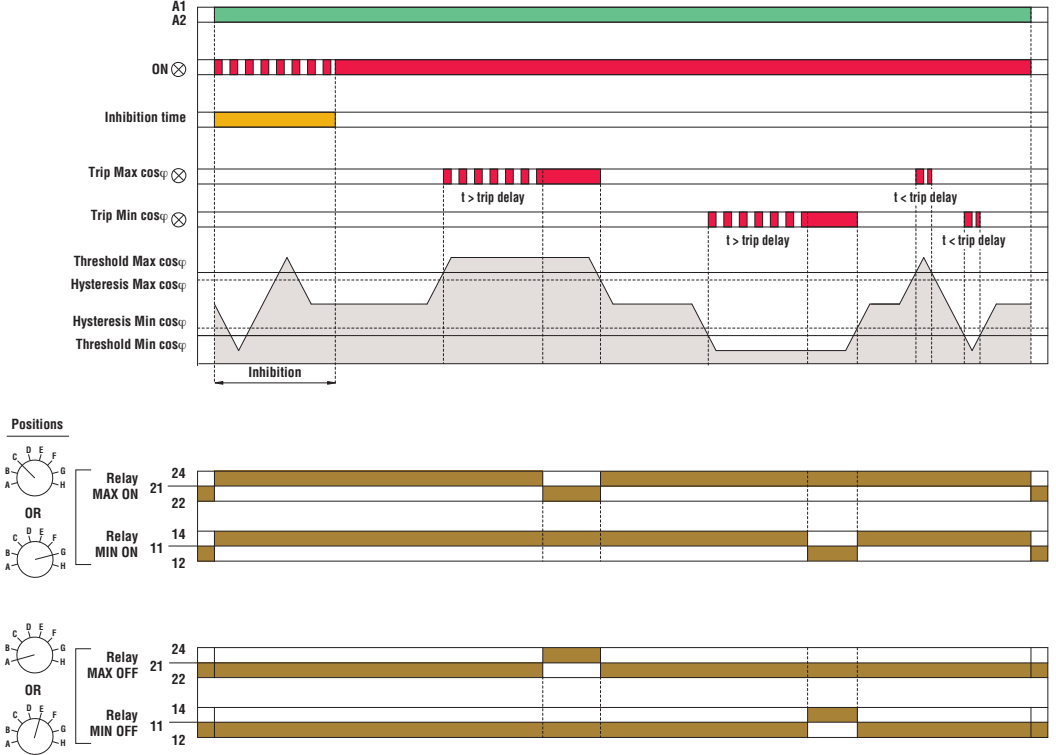

Frequency monitoring relay

PMF20

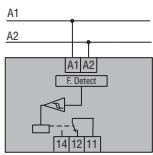

MAX-MIN, MAX or MIN function

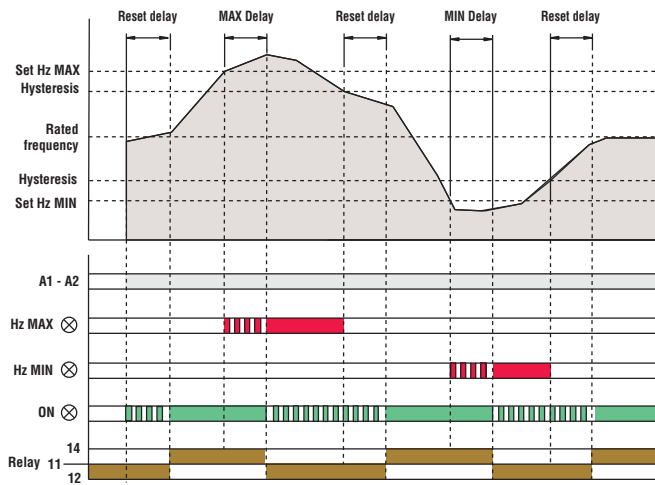

MAX function

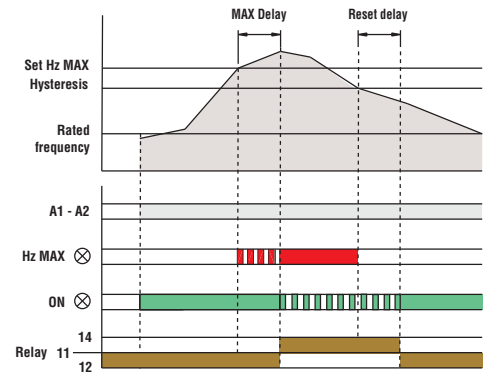

Interface protection systems compliant with Italian CEI 0-21 standard - For low voltage

PMVF 20...

Three-phase connection

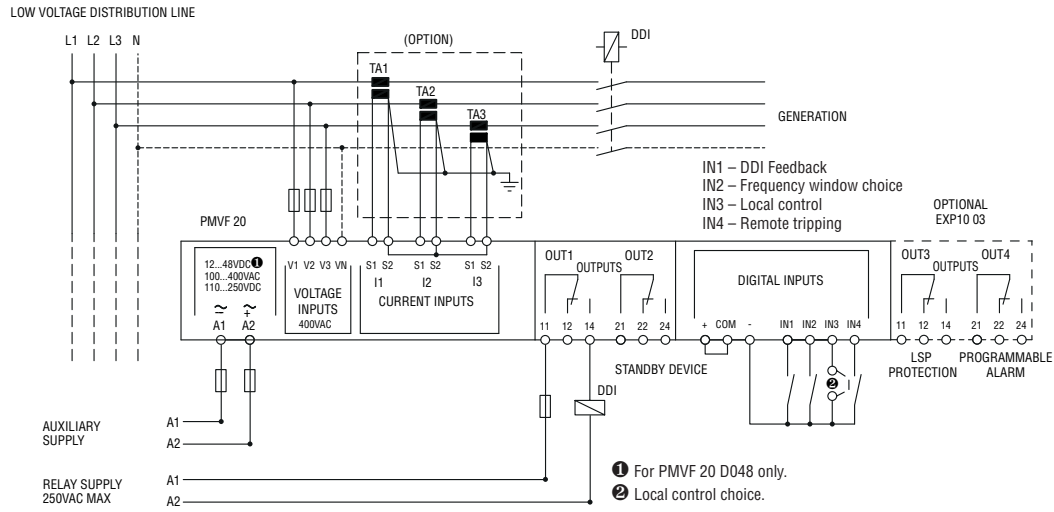

Rear view

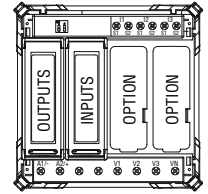

Activation modes for standby device

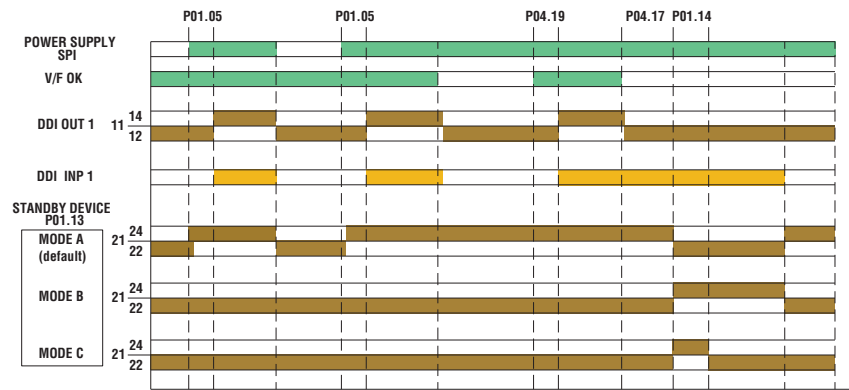

Interface protection systems compliant with Italian CEI 0-21 standard - For low voltage

PMVF 51

Three-phase connection

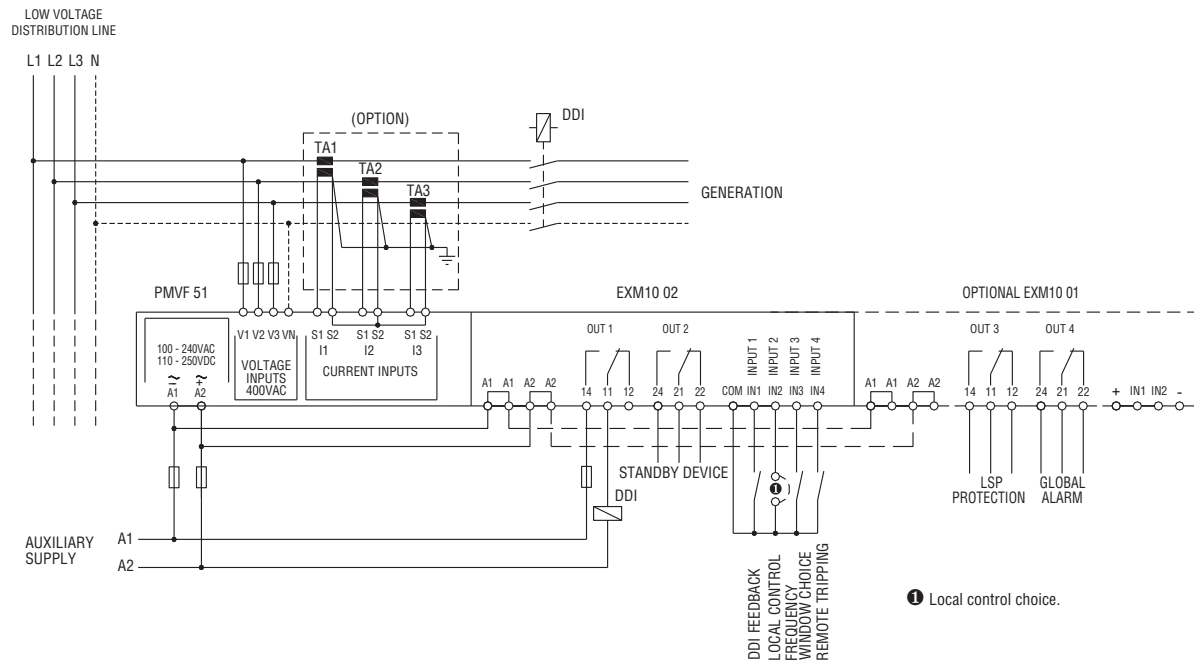

Activation modes for standby device

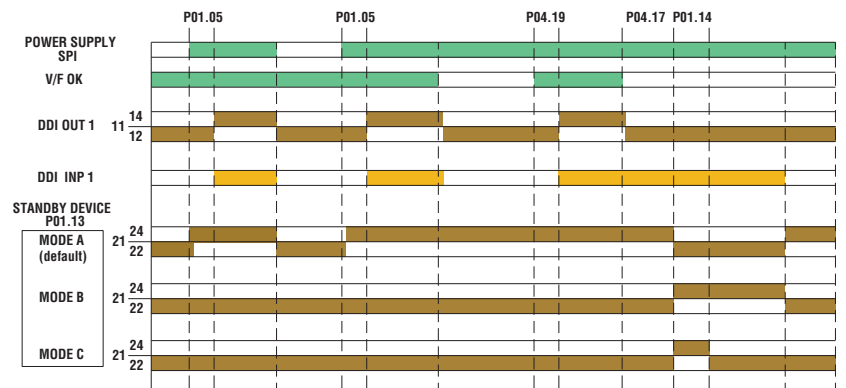

Interface protection systems compliant with Italian CEI 0-16 standard - For medium voltage

PMVF 30...

Connection through VTs in Medium Voltage
Three-phase connection

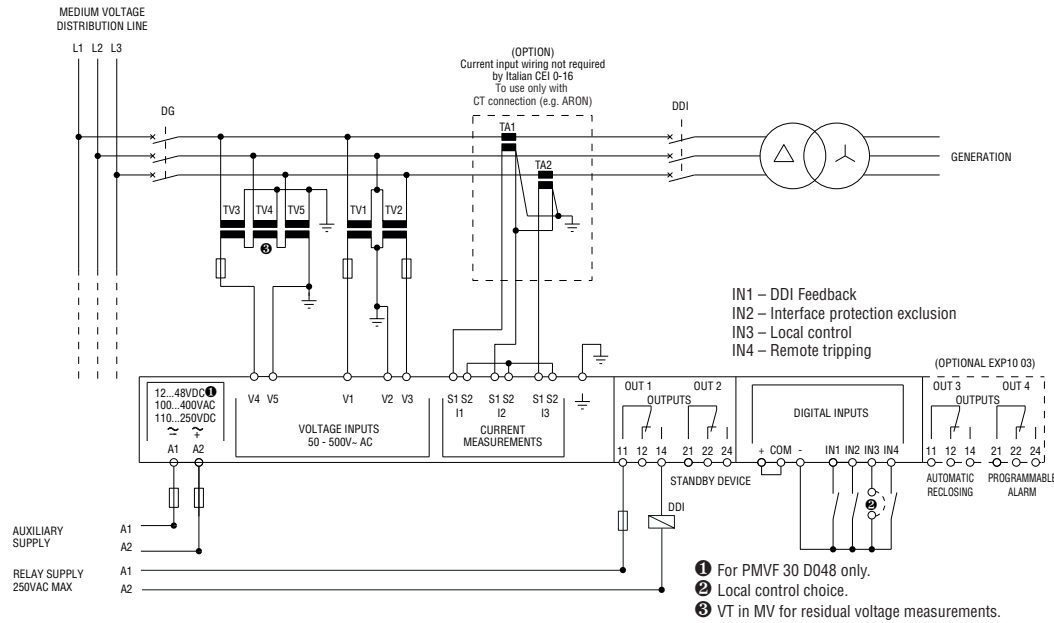

Rear view

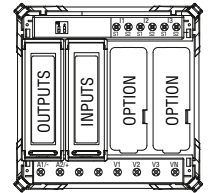

Direct connection in Low Voltage Three-phase connection

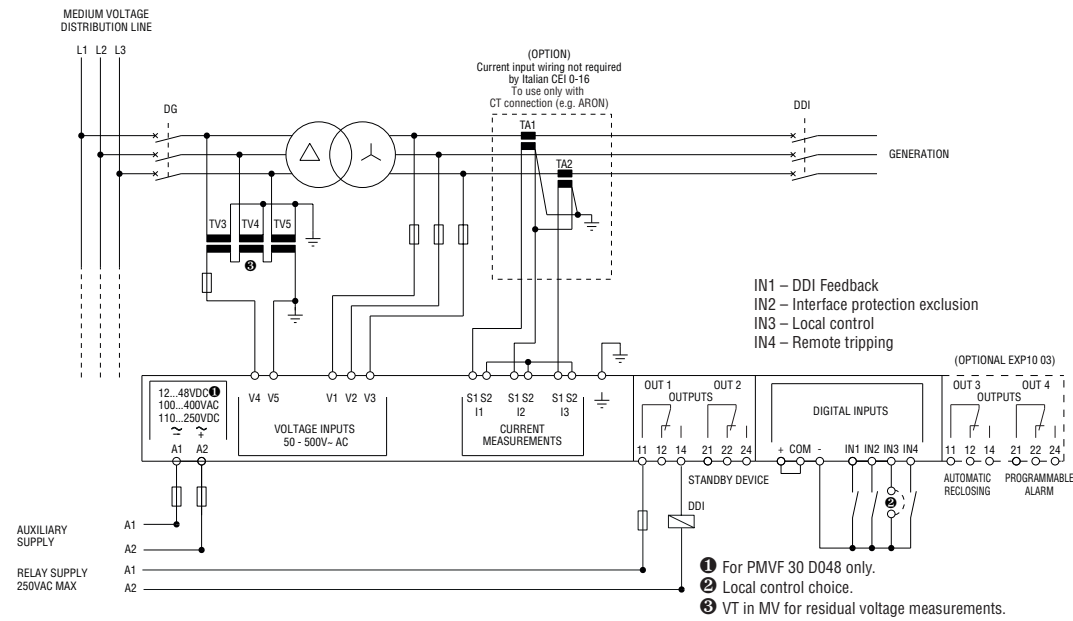

Rear view

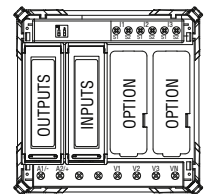

Activation modes for standby device

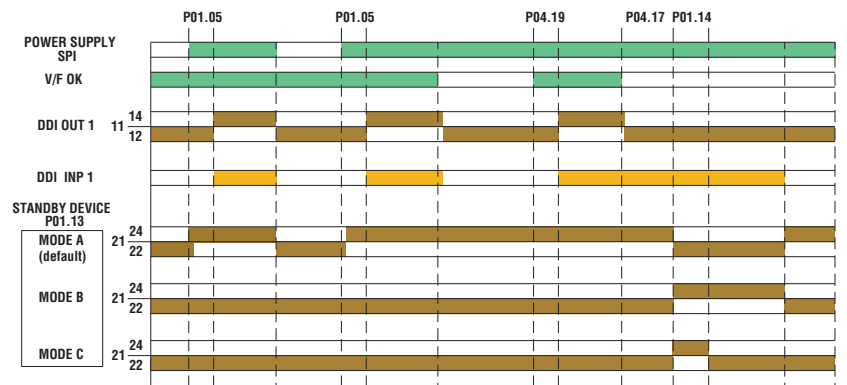

Interface protection systems compliant with Italian CEI 0-16 standard - For medium voltage
PMVF 30... with PMVF GSM 1

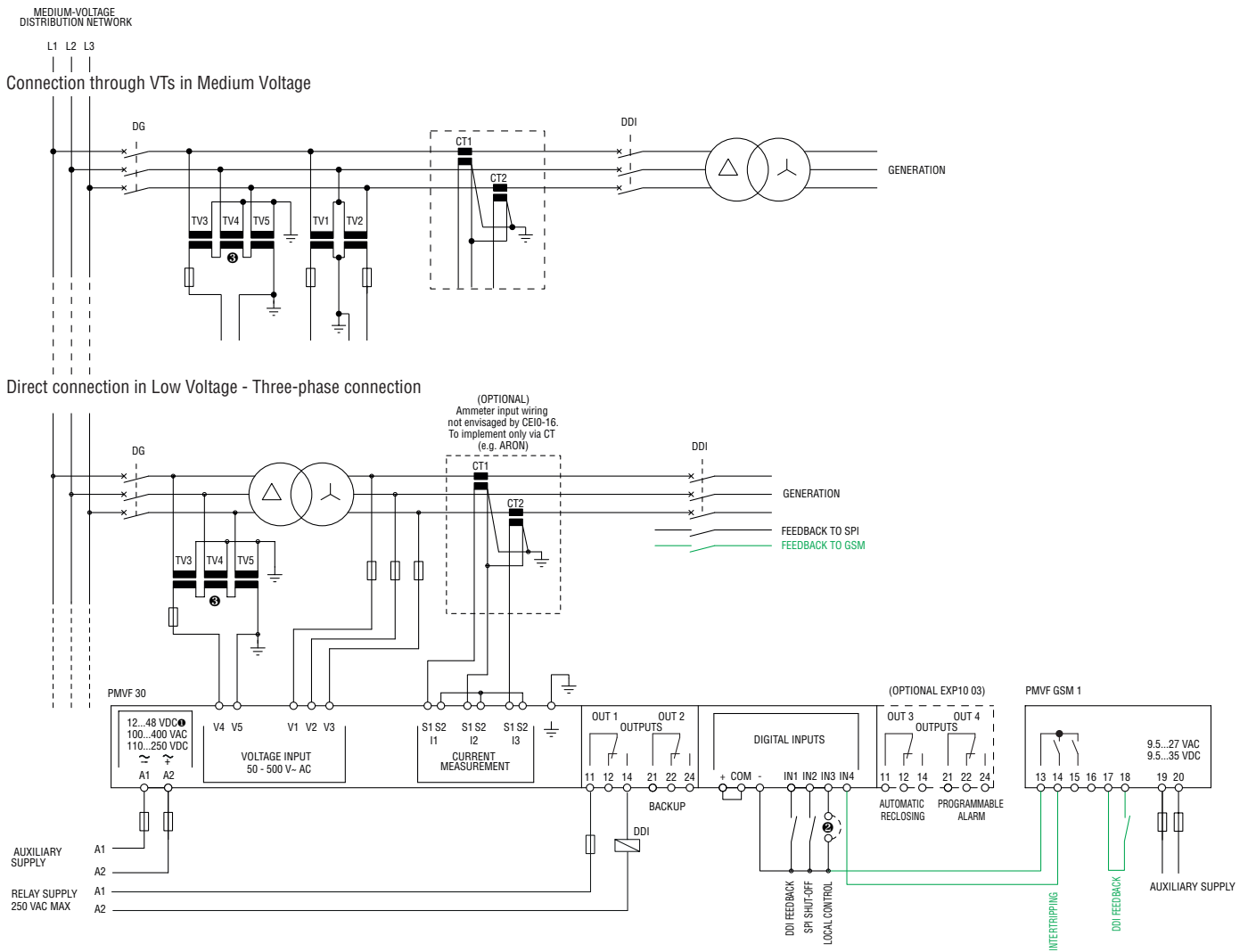

- ❶ For PMVF 30 D048 only.
- ❷ Local control choice.
- ❸ VT in MV for residual voltage measurements.

The connections coloured in GREEN, in addition to the GSM Modem, represent the only wiring necessary for the adaptation.

PMVF GSM 1 modem wiring diagram with other interface protections (PI) with self-supplied remote disconnection input

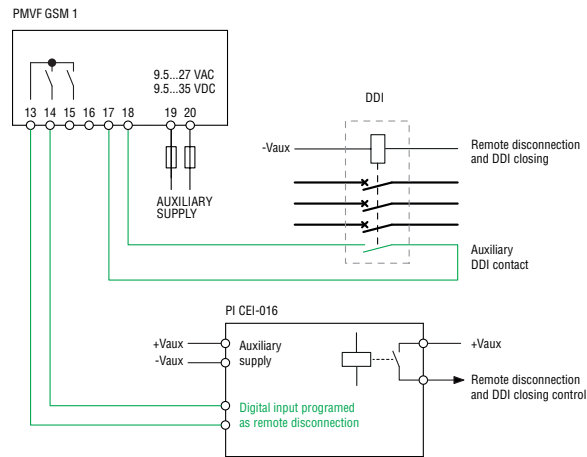

The connections coloured in GREEN, in addition to the GSM Modem, represent the only wiring necessary for the adaptation.

PMVF GSM 1 modem wiring diagram with other interface protections (PI) with remote disconnection input to be supplied

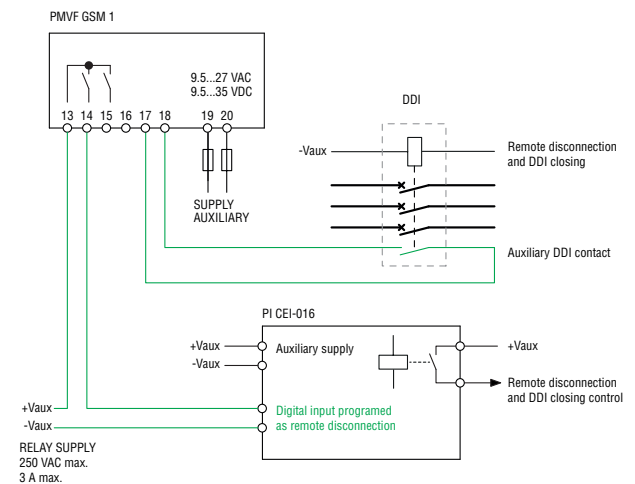

TYPE	Single phase	PMV55	—	—	—	—
	Three phase	—	PMV10	PMV20	PMV30	PMV40
	Three phase with/without neutral	—	—	—	—	—
DESCRIPTION						
	Minimum and maximum AC voltage		Phase loss and incorrect phase sequence		Minimum AC voltage, phase loss and incorrect phase sequence	Asymmetry, phase loss and incorrect phase sequence
CONTROL CIRCUIT						
Rated voltage to control (Ue)	208...240VAC	208...480VAC	100...240VAC	208...240VAC		
	380...440VAC		208...575VAC	380...575VAC		
			380...600VAC	600VAC		
Maximum voltage set-point	105...115% Ue	—	—	—	—	—
Minimum voltage set-point	80...95% Ue	—	—	80...95% Ue	—	—
Asymmetry set-point	—	—	—	—	5...15%Ue	—
Minimum and maximum frequency set-point	—	—	—	—	—	—
Tripping time	0.1...20s		60ms		0.1...20s	
Resetting time	0.1...20s (0.5s at power up)		0.5s		0.1...20s (0.5s at power up)	
Resetting hysteresis	3%		5%		3%	
Instantaneous tripping for Ue	<70% Ue configured		Umin<70% Umax		<70% Ue configured	<70% minimum Ue
Repeat accuracy	< ±0.1%		< ±1%		< ±0.1%	< ±0.1%
POWER SUPPLY						
Auxiliary voltage (Us)	Self powered					
Operating range	0.7...1.2Ue		0.85...1.1Ue		0.7...1.2Ue	
Frequency	50/60Hz ±5%					
Power consumption (maximum)	10VA (208...240VAC)❶ 17VA (380...440VAC)❶		20VA❶		28VA❶	11VA (208...240VAC)❶ 30VA (380...575VAC)❶ 19VA (600VAC)❶
Power dissipation (maximum)	1.5W		2.2W		2.5W	
RELAY OUTPUTS						
Number of relays	1					
Relay state	Normally energised De-energises at tripping					
Contact arrangement	1 changeover SPDT					
Rated operational voltage	250VAC					
Maximum switching voltage	400VAC					
Conventional free-air thermal current (Ith)	8A					
UL/CSA and IEC/EN 60947-5-1 designation	B300					
Electrical life (with rated load)	10 ⁸ cycles					
Mechanical life	30x10 ⁶ cycles					
Indications	1 green LED for power on and tripping 2 red LEDs for tripping		1 green LED for power on and tripping		1 green LED for power on and tripping 1 red LED for tripping	
CONNECTIONS						
Terminal tightening torque (maximum)	0.8Nm (7lbin; 7...9lbin per UL/CSA)					
Conductor section min...max	0.2...4.0mm ² (24...12AWG; 18...12 AWG per UL/CSA)					
INSULATION (input-output)						
IEC rated insulation voltage Ui	440VAC		480VAC		600VAC	
IEC rated impulse withstand voltage Uimp	6kV					
IEC power frequency withstand voltage	4kV					
AMBIENT CONDITIONS						
Operating temperature	-20...+60°C					
Storage temperature	-30...+80°C					
HOUSING						
Material	Self-extinguishing polyamide					

❶ Power consumption (maximum) at 50Hz.

	—	—	—	—	—
	PMV50	PMV70	PMV50 N	PMV70 N	PMV80 N
	—	—	—	—	—
Minimum and maximum AC voltage, phase loss and incorrect phase sequence	Minimum and maximum AC voltage, phase loss, incorrect phase sequence and asymmetry	Minimum and maximum AC voltage, phase loss, neutral loss and incorrect phase sequence	Minimum and maximum AC voltage, phase loss, neutral loss, incorrect phase sequence and asymmetry	Minimum and maximum AC voltage, phase loss, neutral loss and incorrect phase sequence	Minimum and maximum AC voltage and frequency, phase loss, neutral loss and incorrect phase sequence
208...240VAC	208...240VAC	208...240VAC	208...240VAC	208...240VAC	208...240VAC
380...575VAC	380...575VAC	380...440VAC	380...440VAC	380...440VAC	380...440VAC
600VAC	600VAC	480...600VAC	480...600VAC	480...600VAC	480...600VAC
105...15% Ue	105...115% Ue	105...115% Ue	105...115% Ue	105...115% Ue	105...115% Ue
80...95% Ue	80...95% Ue	80...95% Ue	80...95% Ue	80...95% Ue	80...95% Ue
—	5...15% Ue	—	5...15% Ue	—	—
—	—	—	—	—	1...10% rated frequency
0.1...20s					0.1...20s 0.1...5s frequency
0.1...20s (0.5s at power up)	0.5s	0.1...20s	0.5s	0.5s	
3%	3%	3%	3%	3%	0.5% frequency
<70% Ue configured < ±0.1%					
Self powered					
0.7...1.2Ue					
50/60Hz ±5%					
11VA (208...240VAC)ⓘ 30VA (380...575VAC)ⓘ 19VA (600VAC)ⓘ			27VA max		
2.5W			1.9W max		
1			2		
Normally energised De-energises at tripping					
1 changeover SPDT			2 changeover SPDT		
250VAC					
400VAC					
8A					
B300					
10 ⁵ cycles					
30x10 ⁶ cycles					
1 green LED for power on and tripping 2 red LEDs for tripping		1 green LED for power on and tripping 3 red LEDs for tripping		1 green LED for power on and tripping 2 red LEDs for tripping	
0.8Nm (7lbin; 7...9lbin per UL/CSA - PMV...N excluded)					
0.2...4.0mm ² (24...12AWG; 18...12 AWG per UL/CSA - PMV...N excluded)					
600VAC					
6kV					
4kV					
-20...+60°C					
-30...+80°C					
Self-extinguishing polyamide					

TYPE	PMA20	PMA30	PMA40
DESCRIPTION	Single-phase maximum current monitoring AC/DC multiscale	Single-phase minimum or maximum current monitoring AC/DC multiscale	Single-phase minimum and maximum current monitoring AC/DC multiscale
CONTROL CIRCUIT			
Rated current to be monitored I_e	5 or 16A		0.02 - 0.05 - 0.25 - 1 - 5 - 16A
Rated frequency	50/60Hz $\pm 5\%$		
Overload capacity	5 I_e for 1s 160A for 10ms Constant 16A	50mA - 1A inputs	16A input
		5 I_e for 1s 10 I_e for 10ms Constant 2 I_e	5 I_e for 1s 160A for 10ms Constant 16A
Connection	Direct or by current transformer		
Adjustment	Tripping values	5...100% f.s.	
	Tripping time	0.1...30s	
	Inhibition time	1...60s	
	Resetting hysteresis	1...50%	3% fixed
Resetting	Automatic / Manual		
External input	Resetting / Inhibition	—	
Repeat accuracy	$\pm 1\%$ with constant parameters		
AUXILIARY SUPPLY			
Auxiliary supply voltage U_s	24...240VAC/DC		
Operating range	0.85...1.1 U_s		
Rated frequency	50/60Hz $\pm 5\%$		
Power consumption (maximum)	3.2VA	7VA	
Power dissipation (maximum)	1.6W	1.7W	
RELAY OUTPUTS			
Number of relays	1	2	
Relay state	Normally energised / de-energised (selectable)		
Contact arrangement	1 changeover contact SPDT each		
Rated operational voltage	250VAC		
Maximum switching voltage	400VAC		
IEC conventional free air thermal current I_{th}	8A		
UL/CSA and IEC/EN 60947-5-1 designation	B300		
Electrical life (with rated load)	10^5 cycles		
Mechanical life	30×10^6 cycles		
Indications	1 green LED for power on/inhibition 1 red LED for tripping	1 green LED for power on/inhibition 2 red LEDs for max/min tripping	
CONNECTIONS			
Tightening torque maximum	0.8Nm (7lbin; 7...9lbin per UL/CSA)		
Conductor section min...max	0.2...4.0mm ² (24...12AWG; 18...12 AWG per UL/CSA)		
INSULATION (input-output)			
IEC rated insulation voltage U_i	415VAC		
IEC rated impulse withstand voltage U_{imp}	4kV		
IEC power frequency withstand voltage	2.5kV		
AMBIENT CONDITIONS			
Operating temperature	-20...+60°C		
Storage temperature	-30...+80°C		
HOUSING			
Material	Self-extinguishing polyamide		

Protection relays

Technical characteristics

Pump protection and phase shift monitoring relays

TYPE	PMA50	PMA60
DESCRIPTION	Single and three-phase pump protection (motor under-load and over-current control) monitoring for max AC current, min $\cos\varphi$, phase loss and incorrect phase sequence	Single and three-phase shift control for minimum and maximum $\cos\varphi$ monitoring
CURRENT AND $\cos\varphi$ CONTROL CIRCUIT		
Rated current I_e	5 or 16A	16A
Rated frequency	50/60Hz $\pm 5\%$	
Overload capacity	5 I_e for 1s 160A for 10ms Constant 16A	
Connection	Direct or by current transformer	
Adjustments	End-scale value	5 or 16A
	Tripping for MAX current	10...100 I_e
	Tripping for $\cos\varphi$	0.1...0.99 $\cos\varphi$ (MIN)
	Tripping delay	0.1...10s
	Inhibition time	1...60s
	Automatic resetting delay	OFF...100min
External input	Consent for running/resetting	—
Repeat accuracy	$\pm 1\%$ with constant parameters	
VOLTAGE CONTROL CIRCUIT		
Voltage measuring range (U_e)	80...660VAC	
Tripping time for phase loss	60ms	
AUXILIARY SUPPLY		
Auxiliary supply voltage U_s	220...240VAC	
	380...415VAC (maximum voltage for UL/CSA)	
	440...480VAC	
Operating range	0.85...1.1 U_s	0.85...1.1 U_s
Frequency range	50/60Hz $\pm 5\%$	50/60Hz $\pm 5\%$
Power consumption (maximum)	4.5VA	4.4VA
Power dissipation (maximum)	2.3W	2.4W
RELAY OUTPUTS		
Number of relays	1	2
Relay state	Normally energised, de-energises at tripping	Normally energised / de-energised (ON-OFF) (configurable)
Contact arrangement	1 changeover contact SPDT each	
Rated operational voltage	250VAC	
Maximum switching voltage	400VAC	
IEC conventional free air thermal current I_{th}	8A	
UL/CSA and IEC/EN 60947-5-1 designation	B300	
Electrical life (With rated load)	10 ⁵ cycles	
Mechanical life	30x10 ⁶ cycles	
Indications	1 green LED for power on/inhibition 2 red LEDs for minimum/maximum tripping	
CONNECTIONS		
Tightening torque maximum	0.8Nm (7lbin; 7...9lbin per UL/CSA)	
Conductor section min...max	0.2...4.0mm ² (24...12AWG; 18...12 AWG per UL/CSA)	
INSULATION (input-output)		
IEC rated insulation voltage U_i	600VAC	
IEC rated impulse withstand voltage U_{imp}	6kV	
IEC power frequency withstand voltage	2.5kV	
AMBIENT CONDITIONS		
Operating temperature	-20...+60°C	
Storage temperature	-30...+80°C	
HOUSING		
Material	Self-extinguishing polyamide	

TYPE	PMF20	
DESCRIPTION	Single-phase minimum and maximum frequency control	
FREQUENCY CONTROL CIRCUIT		
Rated frequency	50 or 60Hz selectable	
Operating frequency range	40...70Hz	
Adjustment	MAX tripping	101...110% operating frequency
	MIN tripping	90...99% operating frequency
	Resetting hysteresis	0.5%
	Inhibition time	0.1...20s
	Reset delay	0.1...20s
Resetting	Automatic	
Repeat accuracy	< ±0.1%	
AUXILIARY SUPPLY		
Auxiliary supply voltage Us	220...240VAC	
	380...415VAC	
Operating range	0.85...1.1 Us	
Rated frequency	50/60Hz	
Power consumption (maximum)	10VA (220...240VAC); 17VA (380...415VAC)	
Power dissipation (maximum)	1.5W	
RELAY OUTPUTS		
Number of relays	1	
Relay state	Normally energised, de-energises at tripping ^❶	
Contact arrangement	1 changeover contact SPDT	
Rated operational voltage	250VAC	
Maximum switching voltage	400VAC	
IEC conventional free air thermal current Ith	8A	
UL/CSA and IEC/EN 60947-5-1 designation	B300	
Electrical life (with rated load)	10 ⁵ cycles	
Mechanical life	30x10 ⁶ cycles	
Indications	1 green LED for power on/tripping 2 red LEDs for min-max tripping	
CONNECTIONS		
Tightening torque maximum	0.8Nm (7lbin; 7...9lbin per UL/CSA)	
Conductor section min-max	0.2...4.0mm ² (24...12AWG; 18...12 AWG per UL/CSA)	
INSULATION (input - output)		
IEC rated insulation voltage Ui	575VAC	
IEC rated impulse withstand voltage Uimp	6kV	
IEC power frequency withstand voltage	4kV	
AMBIENT CONDITIONS		
Operating temperature	-20...+60°C	
Storage temperature	-30...+80°C	
HOUSING		
Material	Self-extinguishing polyamide	

❶ Normally de-energised, energises at tripping with MAX function configured.

TYPE	PMVF 20	PMVF 20 D048
AUXILIARY POWER SUPPLY		
Rated control supply voltage U_s	100...400VAC/110...250VDC	12...48VDC
Operating limits	90...440VAC/93.5...300VDC	9...70VDC
Frequency	45...55Hz	—
Power consumption	AC supply	6VA at 110VAC; 8VA at 230VAC; 11VA at 400VAC
	DC supply	25mA at 110VDC; 11mA at 250VDC
Power dissipation	AC supply	2.7W at 110VAC; 3W at 220V; 3.9W at 400VAC
	DC supply	2.6W at 110VAC; 2.8W at 250VDC
Micro-breaking immunity	≤ 50 ms at 110VAC ; ≤ 200 ms at 230VAC	≤ 15 ms at 12VDC; ≤ 30 ms at 24VDC; ≤ 70 ms at 48VDC
Overload category	III	III
VOLTAGE INPUTS		
Maximum rated operating voltage	400VAC L-L; 230VAC L-N 50Hz	
Measuring range	20...480VAC L-L; 10...276VAC L-N	
Frequency range	45...55Hz	
Overload category	IV	
CURRENT INPUTS (OPTIONAL)		
Rated operational current I_e	1A or 5A in AC programmable	
Measuring range	For 1A scale: 0.01...1.2A; for 5A scale: 0.01...6A	
Type of input	Shunts powered by external current transformer (low voltage) 5A max.	
Type of measurement	RMS	
Overload capacity	$\pm 20\%$ I_e	
Overload peak	50A for 1 second	
Burden (per phase)	≤ 0.6 W	
RELAY OUTPUTS		
Number of outputs	2	
Type of output	1 changeover contact/SPDT each	
Rated operating voltage	250VAC	
UL/CSA and IEC/EN 60947-5-1 designation	5A 250VAC AC1 /B300 ; 5A 30VDC	
Overload category	III	
DIGITAL INPUTS		
Number and type of inputs	4 negative (NPN)	
Input voltage	24VDC isolated	
Input current	7mA	
SUPPLY/VOLTAGE MEASURING CIRCUIT CONNECTIONS		
Type of terminals	Screw - removable	
Conductor section (min...max)	0.2...2.5mm ² (24...12 AWG)	
Tightening torque	0.5Nm (4.5lbin)	
CURRENT MEASURING CIRCUIT CONNECTIONS		
Type of terminals	Screw - fixed	
Number of terminals	6 for external CT connections	
Conductor section (min...max)	0.2...4mm ² (26...10 AWG)	
Tightening torque	0.8Nm (7lbin)	
RELAY OUTPUT CONNECTIONS		
Type of terminals	Screw - removable	
Conductor section (min...max)	0.2...2.5 mm ² (24...12 AWG)	
Tightening torque	0.5Nm (4.5 lbin)	
INPUT CONNECTIONS – Input terminals		
Type of terminals	Screw - removable	
Conductor section (min...max)	0.2...1.5 mm ² (28...14 AWG)	
Tightening torque	0.18Nm (1.7lbin)	
INPUT CONNECTIONS – COM and auxiliary voltage terminals		
Type of terminals	Screw - removable	
Conductor section (min...max)	0.2...2.5 mm ² (24...12 AWG)	
Tightening torque	0.5Nm (4.5lbin)	
HOUSING		
Material	Polyamide	
Version	Flush mount 96x96mm / 3.78x3.78"	

TYPE	PMVF 51	
AUXILIARY POWER SUPPLY		
Rated control supply voltage U_s	100...240VAC/110...250VDC	
Operating limits	85...264VAC/93.5...300VDC	
Frequency	45...55Hz	
Power consumption	AC supply	4.6VA at 110VAC; 12.5VA at 230VAC
	DC supply	23mA at 110VDC; 11mA 250VDC
Power dissipation	AC supply	2.5W at 110VAC; 2.7W at 230VAC
	DC supply	2.3W at 110VDC; 2.5W at 250VDC
Micro-breaking immunity	≤ 50 ms at 100VDC; ≤ 200 ms at 240VDC	
Overload category	II	
VOLTAGE INPUTS		
Maximum rated operating voltage	400VAC L-L; 230VAC L-N 50Hz	
Measuring range	20...480VAC L-L; 10...276VAC L-N	
Frequency range	45...55Hz	
Overload category	IV	
CURRENT INPUTS (OPTIONAL)		
Rated operational current I_e	1A or 5A in AC programmable	
Measuring range	For 1A scale: 0.01...1.2A; for 5A scale: 0.01...6A	
Type of measurement	RMS	
Overload capacity	$\pm 20\%$ I_e	
Overload peak	50A for 1 second	
Burden (per phase)	≤ 0.6 W	
RELAY OUTPUTS		
Number of outputs	2 	
Type of output	1 changeover contact/SPDT each	
Rated operating voltage	250VAC	
UL/CSA and IEC/EN 60947-5-1 designation	For NO contact: 5A 250VAC AC1/C300; 5A 30VDC For NC contact: 2A 250VAC AC1 / C300; 2A 30VDC	
Overload category	II	
DIGITAL INPUTS		
Number and type of inputs	4 positive (PNP)	
Input voltage	12VDC isolated	
Input current	7mA	
SUPPLY/VOLTAGE MEASURING CIRCUIT CONNECTIONS		
Type of terminals	Screw - removable	
Conductor section (min...max)	0.2...4mm ² (24...12 AWG)	
Tightening torque	0.8Nm (4.5lbin)	
CURRENT MEASURING CIRCUIT CONNECTIONS		
Type of terminals	Screw - fixed	
Number of terminals	6 for external CT connections	
Conductor section (min...max)	0.2...2.5mm ² (24...12 AWG)	
Tightening torque	0.44Nm (4lbin)	
RELAY OUTPUT CONNECTIONS		
Type of terminals	Screw - removable	
Conductor section (min...max)	0.2...2.5 mm ² (24...12 AWG)	
Tightening torque	0.44Nm (4lbin)	
INPUT CONNECTIONS – Input terminals		
Type of terminals	Screw - removable	
Conductor section (min...max)	0.2...2.5 mm ² (24...12 AWG)	
Tightening torque	0.5Nm (4.5lbin)	
HOUSING		
Material	Polyamide	
Version	Modular 6U	

 Single insulation between the two outputs. Both outputs must use the same voltage group.

TYPE		PMVF 30
AUXILIARY POWER SUPPLY		
Rated control supply voltage U_s		100...400VAC/110...250VDC
Operating limits		90...440VAC/93.5...300VDC
Frequency		45...55Hz
Power consumption	AC supply	7.5VA at 110VAC; 10VA at 230VAC; 14VA at 400VAC
	DC supply	35mA at 110VDC; 14mA at 250VDC
Power dissipation	AC supply	4W at 110VAC; 4.2W at 220V; 5W at 400VAC
	DC supply	3.8W at 110VAC; 4W at 250VDC
Micro-breaking immunity		≤ 30 ms at 110VAC ; ≤ 140 ms at 230VAC
Overload category		III
VOLTAGE INPUTS		
Maximum rated operating voltage		50...500VAC (for voltages/frequency) / 50...150V (for residual voltage measurement)
Measuring range (U_n)		400-150,000V (VT primary)
Frequency range		45...55Hz
Overload category		IV
CURRENT INPUTS (OPTIONAL)		
Rated operational current I_e		1A or 5A in AC programmable
Measuring range		For 1A scale: 0.01...1.2A; for 5A scale: 0.01...6A
Type of input		Shunts powered by external current transformer (low voltage) 5A max.
Type of measurement		RMS
Overload capacity		$\pm 100\%$ I_e
Overload peak		50A for 1 second
Burden (per phase)		≤ 0.3 W
RELAY OUTPUTS		
Number of outputs		2
Type of output		1 changeover contact/SPDT each
Rated operating voltage		250VAC
UL/CSA and IEC/EN 60947-5-1 designation		5A 250VAC AC1 /B300; 5A 30VDC
Overload category		III
DIGITAL INPUTS		
Number and type of inputs		4 negative (NPN)
Input voltage		24VDC isolated
Input current		7mA
SUPPLY/VOLTAGE MEASURING CIRCUIT CONNECTIONS		
Type of terminals		Screw - removable
Number of terminals		2 for power supply; 5 for voltage control
Conductor section (min...max)		0.2...2.5mm ² (24...12 AWG)
Tightening torque		0.5Nm (4.5lbin)
CURRENT MEASURING CIRCUIT CONNECTIONS		
Type of terminal		Screw - fixed
Number of terminals		6 for external CT connections
Conductor section (min...max)		0.2...4mm ² (26...10 AWG)
Tightening torque		0.8Nm (7lbin)
RELAY OUTPUT CONNECTIONS		
Type and (number) of terminals		Screw – removable (3)
Conductor section (min...max)		0.2...2.5 mm ² (24...12 AWG)
Tightening torque		0.5Nm (4.5 lbin)
INPUT CONNECTIONS – Input terminals		
Type and (number) of terminals		Screw – removable (4)
Conductor section (min...max)		0.2...1.5 mm ² (28...14 AWG)
Tightening torque		0.18Nm (1.7lbin)
INPUT CONNECTIONS – COM and auxiliary voltage terminals		
Type and (number) of terminals		Screw – removable (3)
Conductor section (min...max)		0.2...2.5 mm ² (24...12 AWG)
Tightening torque		0.5Nm (4.5lbin)
HOUSING		
Material		Polyamide
Version		Flush mount 96x96mm / 3.78x3.78"