



W 260: Standard photoelectric switch series for a broad range of applications

	Photoelectric proximity switches, BGS
	Photoelectric proximity switches, energetic
	Photoelectric reflex switches





- universal voltage 12...24 V DC and 24...240 V AC with potential-free relay contact (SPDT) or, alternatively, adjustable time delay.

A variety of features make these sensors particularly operator-friendly. These include visible red transmitted light used as an alignment aid, or the simple and flexible connection system, glass/stainless steel fibre-optic cables for harsh operating conditions in confined environments. All of these benefits open up applications far beyond handling/warehousing systems, the packaging industry and wood working. All device variants have been granted UL and CSA approval.

The W 260 series with its impressive scanning ranges and features has been specially designed for a wide variety of different applications. The sensors, through-beam photoelectric switches, energetic photoelectric proximity switches, and photoelectric reflex switches with background suppression are contained in robust plastic housings. Handling is simple and user-friendly. Two supply voltages are available:

- low voltage 10...30 V DC with PNP or NPN transistor switching output and test input and

One last highlight: the W 260 complies with EN 50081-1 (interference radiation). This makes it the perfect sensor solution for door and gate control systems in underground garages and for use in residential blocks or hotels.

	Through-beam photoelectric switches
	Photoelectric switches with fibre-optic cable
Proximity mode	
	Photoelectric switches with fibre-optic cable
Through-beam mode	

► WS/WE 260 through-beam photoelectric switches and WT 260 photoelectric proximity switches used for monitoring contours in palletisation systems to ensure that no problems are encountered during packaging.

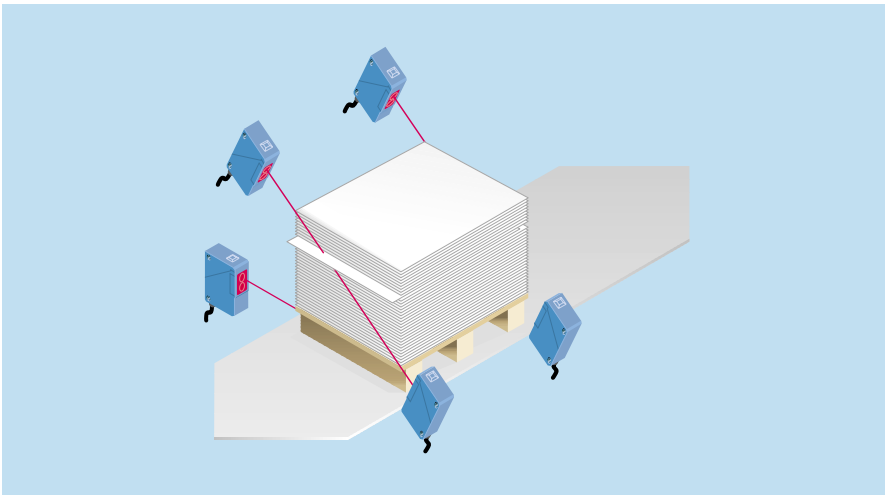

▼ A WT 260 photoelectric proximity switch controlling a commissioning system used in the wood-working industry.



▲ CE conformity to EN 50081-1 and, therefore, the right choice for residential and commercial applications: the WL 260 photoelectric reflex switch used to monitor the closing edges in automatic door and gate systems.

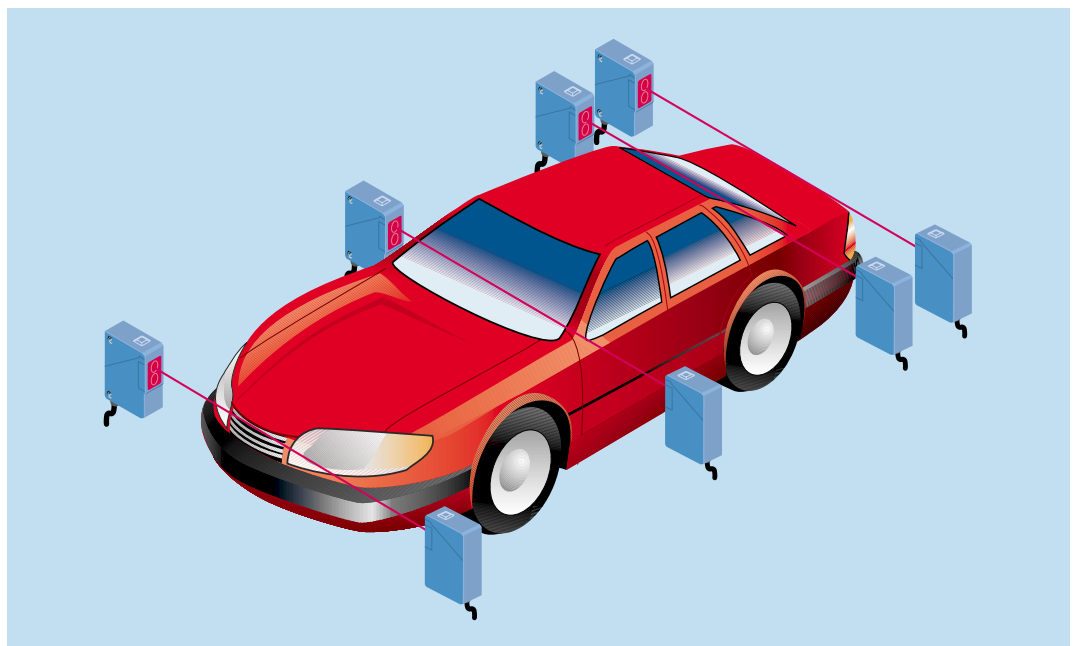

▲ WS/WE 260 through-beam photoelectric switches used for detecting the outline of vehicle bodies on assembly lines in the automotive industry.

Scanning distance
 0...380 mm

Photoelectric proximity switches

- Reliable detection of dark objects even against light backgrounds
- Scanning distance continuously adjustable
- Terminal chamber or M 12 plug, 4-pin or 5-pin
- Test input
- Pre-failure signalling output

Dimensional drawing

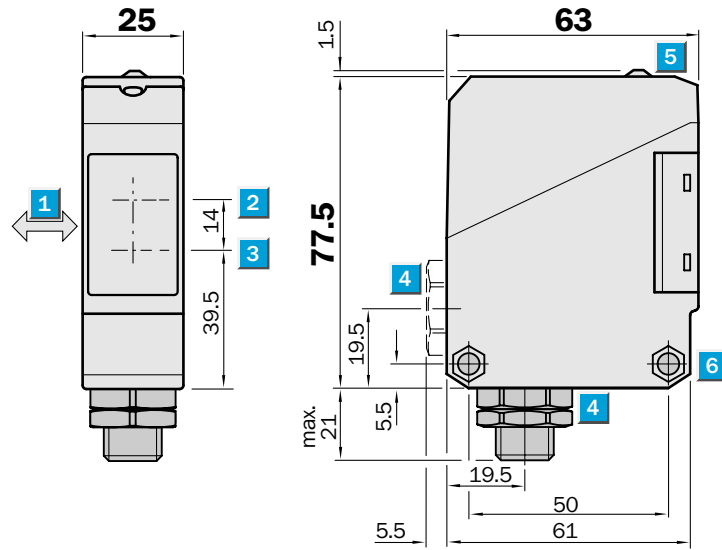

Adjustments possible

WT 260-P 260
WT 260-P 460
WT 260-P 560

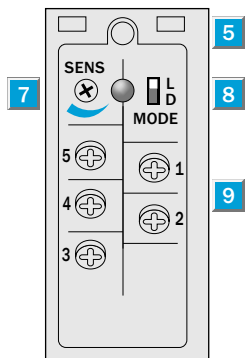

- 1 Standard direction of material being scanned
- 2 Centre of optical axis, receiver
- 3 Centre of optical axis, sender
- 4 Cable entry gland 1/2" PF thread for cable diameters from 6 to 10 mm optionally at bottom or rear; or M 12 equipment plug bottom
- 5 LED signal strength indicator, red
- 6 Through hole \varnothing 5.2 mm on both sides for M 5 hex nut
- 7 Scanning distance adjustment
- 8 Light-/dark-switching (L = light-switching, D = dark-switching)
- 9 Terminals

Connection types

WT 260-P 260	WT 260-P 460	WT 260-P 560
--------------	--------------	--------------

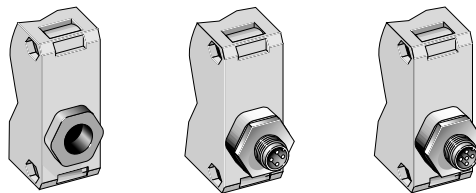

Terminals	4-pin, M 12	5-pin, M 12
-----------	-------------	-------------

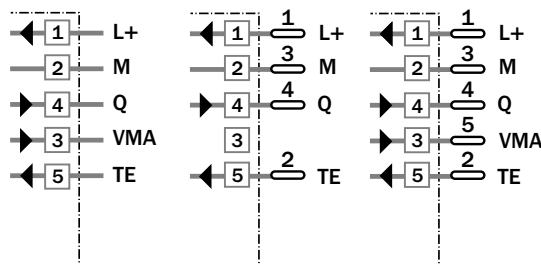

Accessories	page
Cable receptacles M 12	496
Mounting brackets*	510

* included with delivery

Technical data		WT 260-	P 260	P 460	P 560
Scanning distance	Max.: 0...380 mm, adjustable ¹⁾				
	Min.: 75...160 mm, adjustable ¹⁾				
Scanning distance	Adjustable, potentiometer 270°				
Light source²⁾, light type	LED, infrared light				
Light spot diameter	Approx. 17 mm at 300 mm				
Aperture angle sender	Approx. 1.5°				
Supply voltage V_s	10...30 V DC ³⁾				
Ripple ⁴⁾	≤ 5 V _{SS}				
Current consumption ⁵⁾	≤ 35 mA				
Switching outputs	PNP, open collector: Q				
Output current I _A max.	100 mA				
Light receiver, switching mode	Light-/dark-switching by sliding switch				
Response time ⁶⁾	≤ 2 ms				
Max. switching frequency ⁷⁾	250/s				
Pre-failure signalling output VMA ⁸⁾	100 mA, static				
Test input "TE" sender off	PNP: TE to + V _s				
Connection types	Terminal chamber				
	Plug M 12, 4-pin				
	Plug M 12, 5-pin				
VDE protection class⁹⁾	□				
Circuit protection¹⁰⁾	A, B, C, D				
Enclosure rating	IP 66				
Ambient temperature T_A	Operation - 25 °C...+ 55 °C				
	Storage - 40 °C...+ 70 °C				
Weight	Approx. 120 g				
Material	Housing: ABS; optics: PC				

- | | | | |
|--|------------------------------|---|---------------------------|
| 1) Object with 90 % remission (based on standard white DIN 5033) | 5) Without load | 10) A = V _s connections reverse-polarity protected | 11) Black = 6 % remission |
| 2) Average service life 100,000 h at T _A = + 25 °C | 6) With resistive load | B = Inputs/outputs reverse-polarity protected | Grey = 18 % remission |
| 3) Limit values | 7) With light/dark ratio 1:1 | C = Interference suppression | White = 90 % remission |
| 4) Must be within V _s tolerances | 8) Operating reserve < 50 % | D = Outputs overcurrent and short-circuit protected | |
| | 9) Reference voltage 50 V DC | | |

Scanning distance

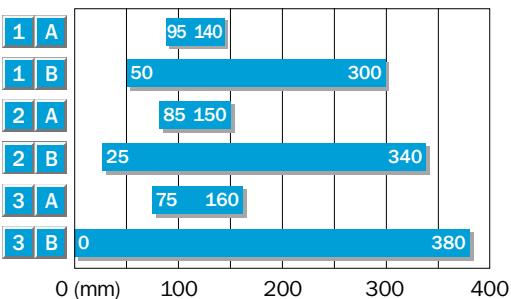

- | | |
|---|--|
| 1 | Scanning range on black ¹¹⁾ /background white |
| 2 | Scanning range on grey ¹¹⁾ /background white |
| 3 | Scanning range on white ¹¹⁾ /background white |
| A | Scanning distance control set to MIN |
| B | Scanning distance control set to MAX |

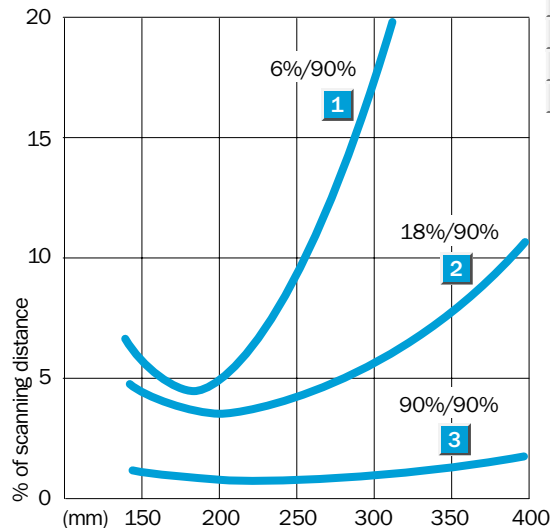

Order information

Type	Part no.
WT 260-P 260	6 009 471
WT 260-P 460	1 011 540
WT 260-P 560	1 011 541

Scanning distance
0...380 mm

Photoelectric proximity switches

- Reliable detection of dark objects even against light backgrounds
- Scanning distance continuously adjustable
- Terminal chamber
- Universal current supply, relay output, SPST, timer optional

Dimensional drawing

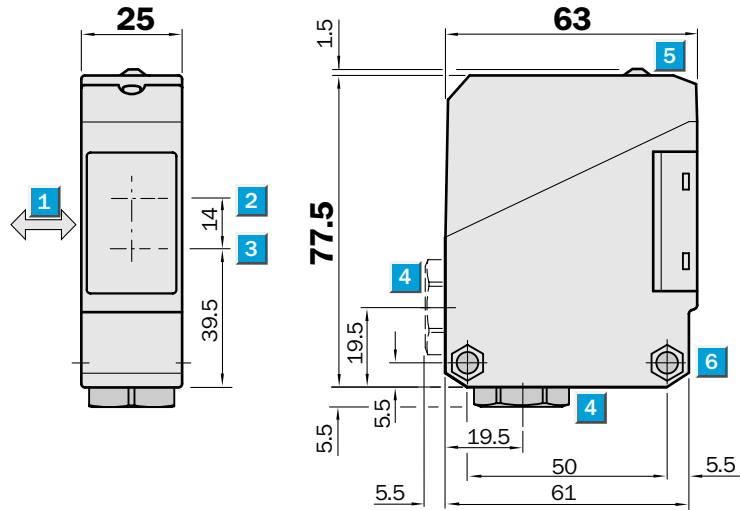

Adjustments possible

WT 260-S 260 WT 260-R 260

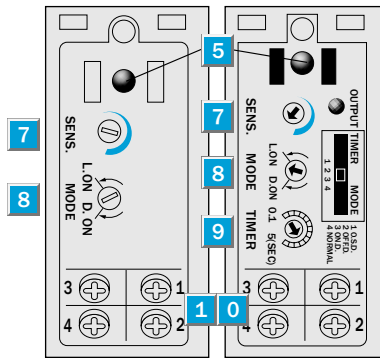

- 1 Standard direction of material being scanned
- 2 Centre of optical axis, receiver
- 3 Centre of optical axis, sender
- 4 Cable entry gland 1/2" PF thread for cable diameters from 6 to 10 mm optionally at bottom or rear
- 5 LED signal strength indicator, red
- 6 Through hole \varnothing 5.2 mm on both sides for M 5 hex nut
- 7 Scanning distance adjustment
- 8 Light/dark rotary switch (L.ON = light-switching, D.ON = dark-switching)
- 9 Time range control
- 1 0 Terminals
- 1 1 Red LED status indicator; switching output active
- 1 2 Time delay selector switch
O.S.D. = One Shot
OFF.D. = OFF delay
ON.D. = ON delay
Normal = No delay



Connection type

WT 260-S 260
WT 260-R 260

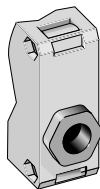

Terminals

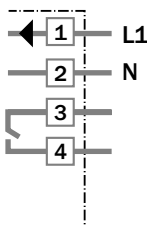

Accessories	page
Mounting brackets*	510

* included with delivery

Time delay

t = 0.1 - 5 s

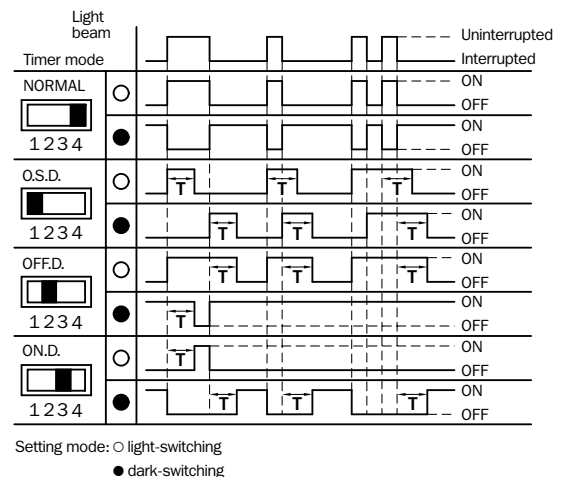

Technical data		WT 260-	S 260	R 260								
Scanning distance	Max.: 0...380 mm, adjustable ¹⁾											
	Min.: 75...160 mm, adjustable ¹⁾											
Scanning distance	Adjustable, potentiometer 270°											
Light source²⁾, light type	LED, infrared light											
Light spot diameter	Approx. 17 mm at 300 mm											
Angle of dispersion, sender	Approx. 1.5°											
Supply voltage V_s³⁾	12...240 V DC											
	24...240 V AC											
Power consumption	≤ 5 VA											
Switching outputs	Relay, SPST, electrically isolated											
Switching current I _A max. ⁴⁾	3 A/240 V AC; 3 A/30 V DC											
Light receiver, switching mode	Light-/dark-switching by rotary switch											
Response time	≤ 20 ms											
Max. switching frequency ⁵⁾	25/s											
Time delay	With LED display: switching output active											
Switch position:	«1 O.S.D.»	«One shot»										
	«2 OFF.D.»	OFF delay										
	«3 ON.D.»	ON delay										
	«4 Normal»	No delay										
Delay	Adjustable, 0.1...5 s; potentiom. 270°											
Connection type	Terminal chamber											
VDE protection class⁶⁾	□											
Circuit protection⁷⁾	A, C											
Enclosure rating	IP 66											
Ambient temperature T_A	Operation -25 °C...+55 °C											
	Storage -40 °C...+70 °C											
Weight	Approx. 120 g											
Material	Housing: ABS; optics: PC											

- 1) Object with 90 % remission (based on standard white DIN 5033)
- 2) Average service life 100,000 h at T_A = +25 °C
- 3) ± 10 %
- 4) Provide suitable spark suppression for inductive or capacitive loads
- 5) With light/dark ratio 1:1
- 6) Reference voltage 250 V UC
- 7) A = V_s connections reverse-polarity protected
C = Interference suppression
- 8) Black = 6 % remission
Grey = 18 % remission
White = 90 % remission

Scanning distance

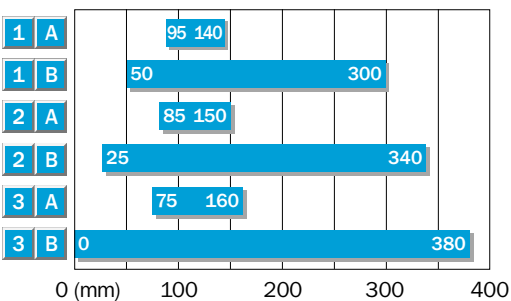

- 1 Scanning range on black⁸⁾/background white
- 2 Scanning range on grey⁸⁾/background white
- 3 Scanning range on white⁸⁾/background white
- A Scanning distance control set to MIN
- B Scanning distance control set to MAX

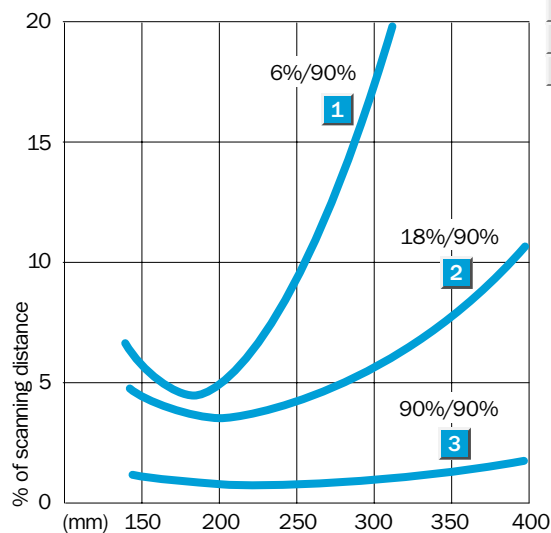

Order information

Type	Part no.
WT 260-S 260	6 009 473
WT 260-R 260	6 009 472

Scanning distance
10...3200 mm

Photoelectric proximity switches

- Adjustable sensitivity
- Terminal chamber or M 12, 4-pin plug
- Test input

Dimensional drawing

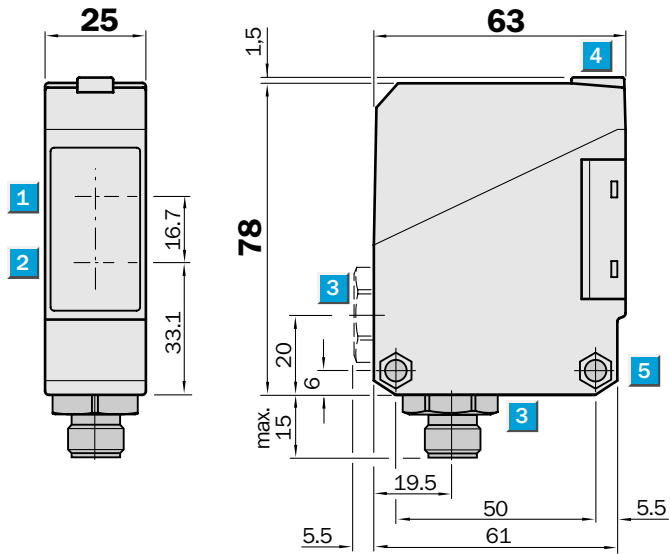

Adjustments possible

WT 260-F 280
WT 260-F 480
WT 260-E 280

- 1** Centre of optical axis, receiver
- 2** Centre of optical axis, sender
- 3** Cable entry gland 1/2" PF thread for cable diameters from 6 to 10 mm optionally at bottom or rear; or M 12 equipment plug, bottom
- 4** LED signal strength indicator, yellow, switching output active
- 5** Through hole \varnothing 5.2 mm on both sides for M 5 hex nut
- 6** Sensitivity adjustment
- 7** Light/dark rotary switch
L.ON = light-switching, D.ON = dark-switching
- 8** Terminals

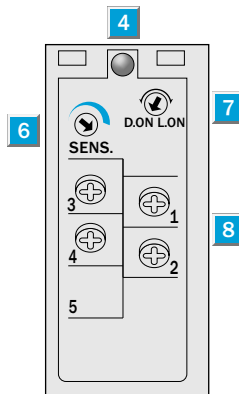

Connection types

WT 260-F 280	WT 260-F 480
WT 260-E 280	

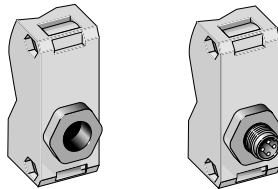

Terminals 4-pin, M 12

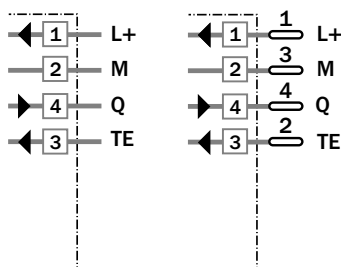

Accessories	page
Cable receptacles	496
Mounting brackets*	510

* included with delivery

Technical data		WT 260-	F 280	F 480	E 280
Scanning distance	0...3200 mm, adjustable ¹⁾				
Operating distance	15...2500 mm, adjustable ¹⁾				
Sensitivity	Adjustable, potentiometer 270°				
Light source²⁾, light type	LED, infrared light				
Light spot diameter	Approx. 80 mm at 2500 mm				
Angle of dispersion, sender	Approx. 1.8°				
Supply voltage V_s	10...30 V DC ³⁾				
Ripple ⁴⁾	$\leq 5 V_{SS}$				
Current consumption ⁵⁾	≤ 35 mA				
Switching outputs	PNP, open collector: Q NPN, open collector: Q				
Output current I_A max.	100 mA				
Light receiver, switching mode	Light-/dark-switching by rotary switch				
Response time ⁶⁾	≤ 5.0 ms				
Max. switching frequency ⁷⁾	100/s				
Test input "TE" sender off	PNP: TE to + V_s NPN: TE to 0 V				
Connection types	Terminal chamber Plug M 12, 4-pin				
VDE protection class⁸⁾	<input type="checkbox"/>				
Circuit protection⁹⁾	A, B, C, D				
Enclosure rating	IP 67				
Ambient temperature T_A	Operation -25 °C...+55 °C Storage -40 °C...+70 °C				
Weight	Approx. 120 g				
Material	Housing: ABS; optics: PC				

- | | | |
|--|------------------------------------|---|
| 1) Object with 90 % remission (based on standard white DIN 5033) | 4) Must be within V_s tolerances | 9) A = V_s connections reverse-polarity protected |
| 2) Average service life 100,000 h at $T_A = +25$ °C | 5) Without load | B = Inputs/outputs reverse-polarity protected |
| 3) Limit values | 6) With resistive load | C = Interference suppression |
| | 7) With light/dark ratio 1:1 | D = Outputs overcurrent and short-circuit protected |
| | 8) Reference voltage 50 V DC | |

Scanning distance

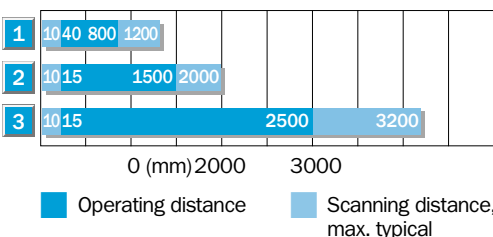

- | | |
|---|---|
| 1 | Scanning range on black, 6 % remission |
| 2 | Scanning range on grey, 18 % remission |
| 3 | Scanning range on white, 90 % remission |

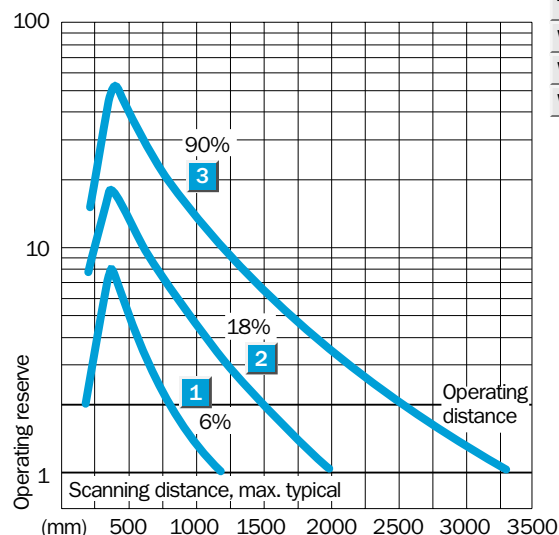

Order information

Type	Part no.
WT 260-F 280	6 020 982
WT 260-F 480	6 020 983
WT 260-E 280	6 020 984

Scanning distance
10...3500 mm

Photoelectric proximity switches

- Adjustable sensitivity
- Terminal chamber
- Universal current supply, relay output, SPDT, timer optional, t_{ON} and t_{OFF} can be connected separately
- Enclosure rating IP 67
- CE noise radiation EN 50081-1 ("Residential standard")

Dimensional drawing

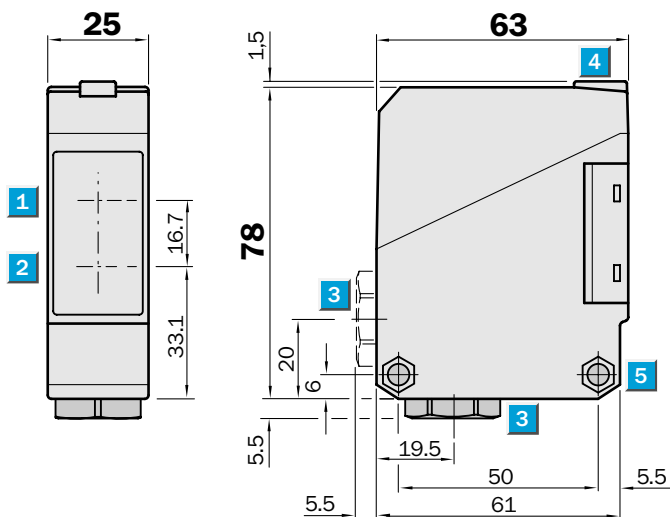

Adjustments possible

WT 260-S 280 WT 260-R 280

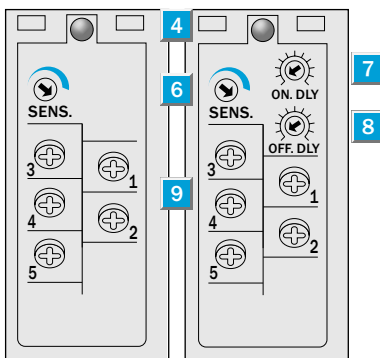

- 1 Centre of optical axis, receiver
- 2 Centre of optical axis, sender
- 3 Cable entry gland 1/2" PF thread for cable diameters from 6 to 10 mm optionally at bottom or rear
- 4 LED signal strength indicator, red
- 5 Through hole \varnothing 5.2 mm on both sides for M 5 hex nut
- 6 Sensitivity adjustment
- 7 Time control ON-delay t_{ON}
- 8 Time control OFF-delay t_{OFF}
- 9 Terminals



Connection type

WT 260-S 280
WT 260-R 280

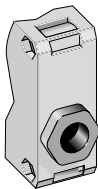

Terminals

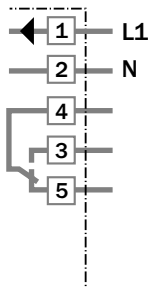

Time delay

$t = 0.1 - 10 \text{ s}$

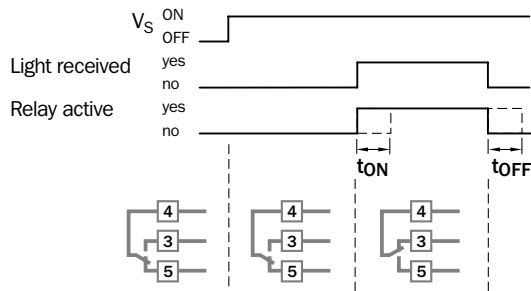

Accessories	page
Mounting brackets*	510

* included with delivery

Technical data		WT 260-	S 280	R 280								
Scanning distance , max. typical	10...3500 mm, adjustable ¹⁾											
Operating distance	20...3000 mm, adjustable ¹⁾											
Sensitivity	Adjustable, potentiometer 270°											
Light source²⁾, light type	LED, infrared light											
Light spot diameter	Approx. 95 mm at 3000 mm											
Angle of dispersion, sender	Approx. 1.7°											
Supply voltage V_s³⁾	12...240 V DC											
	24...240 V AC											
Power consumption	≤ 5 VA											
Switching output	Relay, SPDT, electrically isolated											
Switching current I_{max} ⁴⁾	3 A/240 V AC; 3 A/30 V DC											
Light receiver, switching mode	Light-switching											
Response time	≤ 20 ms											
Max. switching frequency ⁵⁾	25/s											
Time delays												
ON delay t_{ON}	0.1...10 s, can be connected separately											
OFF delay t_{OFF}	0.1...10 s, can be connected separately											
Connection type	Terminal chamber											
CE noise radiation	Level EN 50081-1 ("Residential standard")											
VDE protection class⁶⁾	<input type="checkbox"/>											
Circuit protection⁷⁾	A, C											
Enclosure rating	IP 67											
Ambient temperature T_A	Operation - 25 °C...+ 55 °C Storage - 40 °C...+ 70 °C											
Weight	Approx. 120 g											
Material	Housing: ABS; optics: PC											

- 1) Object with 90 % remission (based on standard white DIN 5033)
- 2) Average service life 100,000 h at $T_A = + 25 °C$
- 3) ± 10 %
- 4) Provide suitable spark suppression for inductive or capacitive loads
- 5) With light/dark ratio 1:1
- 6) Reference voltage 250 V UC
- 7) A = V_s connections reverse-polarity protected
C = Interference suppression

Scanning distance

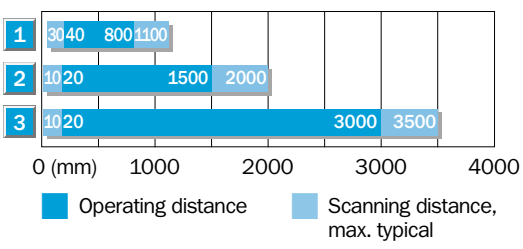

- 1 Scanning range on black, 6 % remission
- 2 Scanning range on grey, 18 % remission
- 3 Scanning range on white, 90 % remission

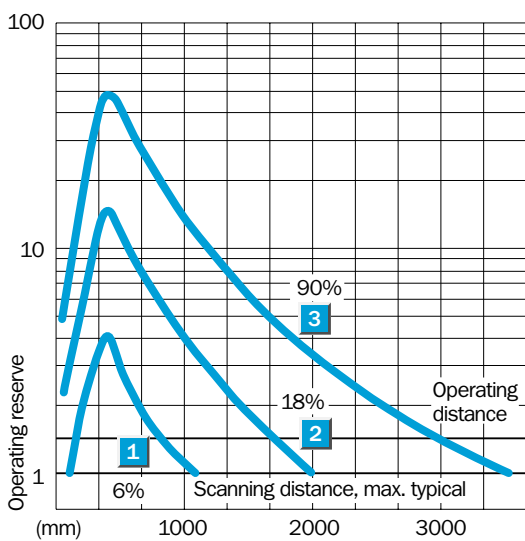

Order information

Type	Part no.
WT 260-S 280	6 020 771
WT 260-R 280	6 020 772

Scanning distance
 5...1500 mm

Photoelectric proximity switches

- Adjustable sensitivity
- Terminal chamber or M 12, 4-pin plug
- Test input

Dimensional drawing

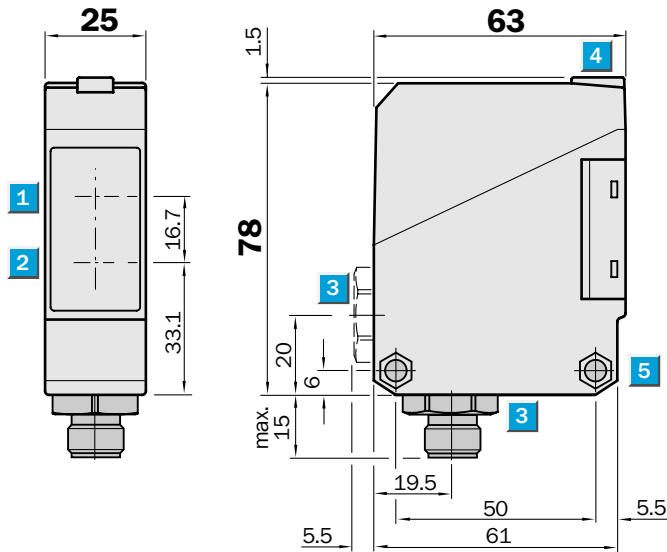

Adjustments possible

- WT 260-F 270
- WT 260-F 470
- WT 260-E 270

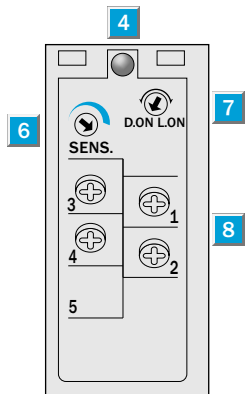

- 1 Centre of optical axis, receiver
- 2 Centre of optical axis, sender
- 3 Cable entry gland 1/2" PF thread for cable diameters from 6 to 10 mm optionally at bottom or rear; or M 12 equipment plug, bottom
- 4 LED signal strength indicator, yellow, switching output active
- 5 Through hole \varnothing 5.2 mm on both sides for M 5 hex nut
- 6 Sensitivity adjustment
- 7 Light/dark rotary switch
L.ON = light-switching, D.ON = dark-switching
- 8 Terminals

Connection types

- WT 260-F 270
- WT 260-F 470
- WT 260-E 270

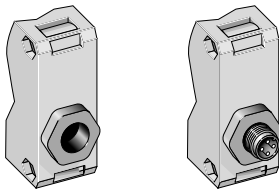

Terminals 4-pin, M 12

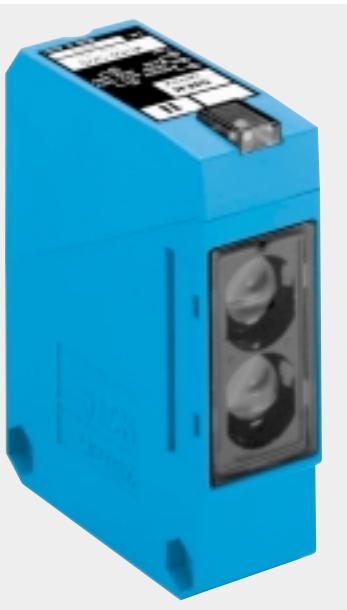
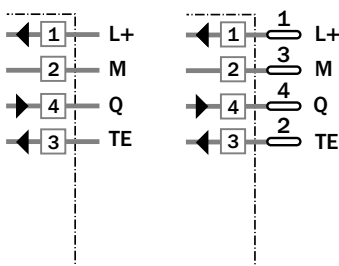

Accessories	page
Cable receptacles	496
Mounting brackets*	510

* included with delivery

Technical data		WT 260-	F 270	F 470	E 270
Scanning distance	5...1500 mm, adjustable ¹⁾				
Operating distance	5...1000 mm, adjustable ¹⁾				
Sensitivity	Adjustable, potentiometer 270°				
Light source²⁾, light type	LED, infrared light				
Light spot diameter	Approx. 45 mm at 1000 mm				
Angle of dispersion, sender	Approx. 2.5°				
Supply voltage V_s	10...30 V DC ³⁾				
Ripple ⁴⁾	$\leq 5 V_{SS}$				
Current consumption ⁵⁾	≤ 35 mA				
Switching outputs	PNP, open collector: Q NPN, open collector: Q				
Output current I_A max.	100 mA				
Light receiver, switching mode	Light-/dark-switching by rotary switch				
Response time ⁶⁾	≤ 1.5 ms				
Max. switching frequency ⁷⁾	333/s				
Test input "TE" sender off	PNP: TE to $+V_s$ NPN: TE to 0 V				
Connection types	Terminal chamber Plug M 12, 4-pin				
VDE protection class⁸⁾	<input type="checkbox"/>				
Circuit protection⁹⁾	A, B, C, D				
Enclosure rating	IP 67				
Ambient temperature T_A	Operation -25 °C... $+55$ °C Storage -40 °C... $+70$ °C				
Weight	Approx. 120 g				
Material	Housing: ABS; optics: PC				

- | | | | |
|--|------------------------------------|--|---|
| 1) Object with 90 % remission (based on standard white DIN 5033) | 4) Must be within V_s tolerances | 9) A = V_s connections reverse-polarity protected
B = Inputs/outputs reverse-polarity protected | C = Interference suppression
D = Outputs overcurrent and short-circuit protected |
| 2) Average service life 100,000 h at $T_A = +25$ °C | 5) Without load | | |
| 3) Limit values | 6) With resistive load | | |
| | 7) With light/dark ratio 1:1 | | |
| | 8) Reference voltage 50 V DC | | |

Scanning distance

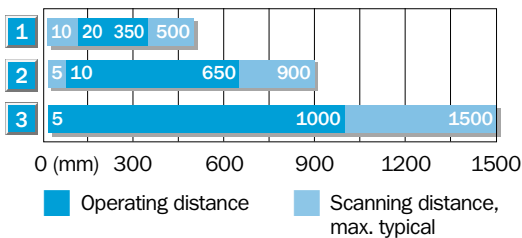

- | | |
|---|---|
| 1 | Scanning range on black, 6 % remission |
| 2 | Scanning range on grey, 18 % remission |
| 3 | Scanning range on white, 90 % remission |

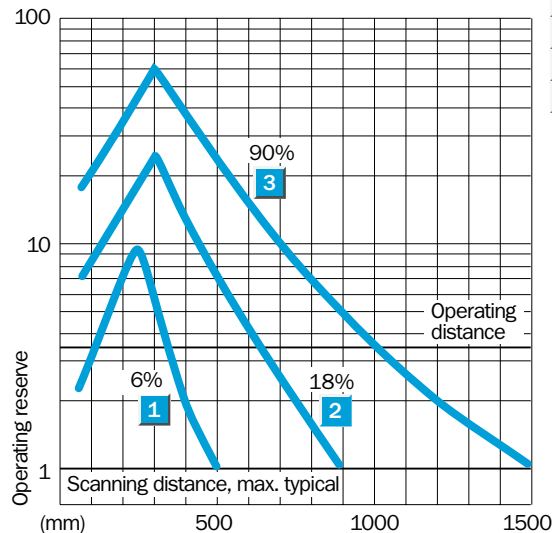

Order information

Type	Part no.
WT 260-F 270	6 020 979
WT 260-F 470	6 020 980
WT 260-E 270	6 020 981

Scanning distance
5...1700 mm

Photoelectric proximity switches

- Adjustable sensitivity
- Terminal chamber
- Universal current supply, Relay output, SPDT, timer optional, t_{ON} and t_{OFF} can be connected separately
- Enclosure rating IP 67
- CE noise radiation EN 50081-1 ("Residential standard")

Dimensional drawing

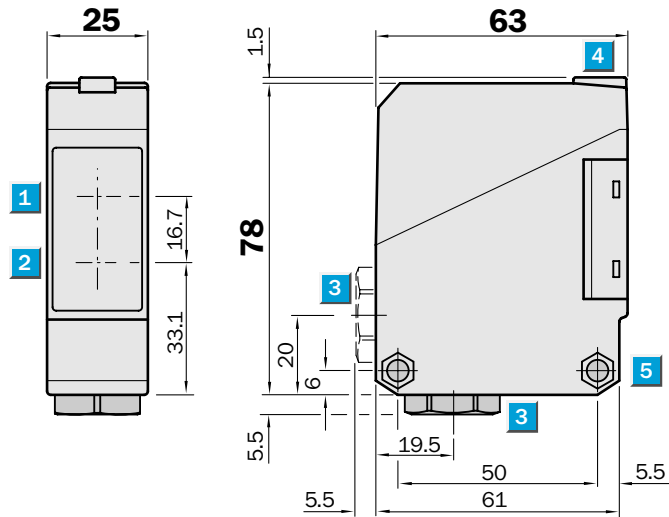

Adjustments possible

WT 260-S 270 WT 260-R 270

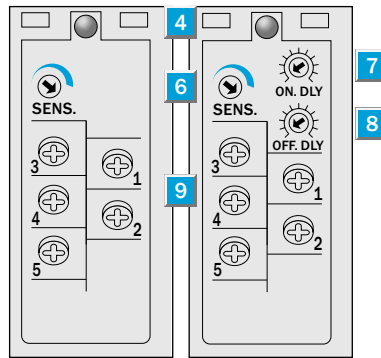

- 1 Centre of optical axis, receiver
- 2 Centre of optical axis, sender
- 3 Cable entry gland 1/2" PF thread for cable diameters from 6 to 10 mm optionally at bottom or rear
- 4 LED signal strength indicator, red
- 5 Through hole \varnothing 5.2 mm on both sides for M 5 hex nut
- 6 Sensitivity adjustment
- 7 Time control ON-delay t_{ON}
- 8 Time control OFF-delay t_{OFF}
- 9 Terminals



Connection type

WT 260-S 270
WT 260-R 270

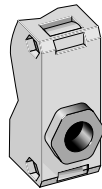

Terminals

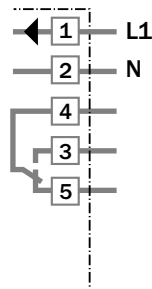

Time delay

$t = 0.1 - 10 \text{ s}$

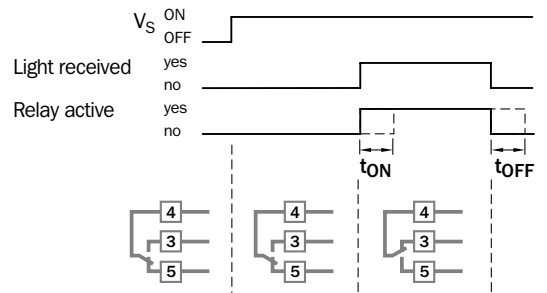

Accessories	page
Mounting brackets*	510

* included with delivery

Technical data		WT 260-	S 270	R 270								
Scanning distance , max. typical	5...1700 mm, adjustable ¹⁾											
Operating distance	5...1300 mm, adjustable ¹⁾											
Sensitivity	Adjustable, potentiometer 270°											
Light source²⁾, light type	LED, infrared light											
Light spot diameter	Approx. 60 mm at 1300 mm											
Angle of dispersion, sender	Approx. 1.8°											
Supply voltage V_S³⁾	12...240 V DC											
	24...240 V AC											
Power consumption	≤ 5 VA											
Switching output	Relay, SPDT, electrically isolated											
Switching current I max ⁴⁾	3 A/240 V AC; 3 A/30 V DC											
Light receiver, switching mode	Light-switching											
Response time	≤ 20 ms											
Max. switching frequency ⁵⁾	25/s											
Time delays												
ON-delay t _{ON}	0.1...10 s, can be connected separately											
OFF-delay t _{OFF}	0.1...10 s, can be connected separately											
Connection type	Terminal chamber											
CE noise radiation	Level EN 50081-1 ("Residential standard")											
VDE protection class⁶⁾	□											
Circuit protection⁷⁾	A, C											
Enclosure rating	IP 67											
Ambient temperature T_A	Operation -25 °C...+55 °C Storage -40 °C...+70 °C											
Weight	Approx. 120 g											
Material	Housing: ABS; optics: PC											

- 1) Object with 90 % remission (based on standard white DIN 5033)
- 2) Average service life 100,000 h at T_A = +25 °C
- 3) ± 10 %
- 4) Provide suitable spark suppression for inductive or capacitive loads
- 5) With light/dark ratio 1:1
- 6) Reference voltage 250 V UC
- 7) A = V_S connections reverse-polarity protected
C = Interference suppression

Scanning distance		Order information	
1	10 20 40 450	Type	Part no.
2	50 800 900	WT 260-S 270	6 020 769
3	50 1300 1700	WT 260-R 270	6 020 770

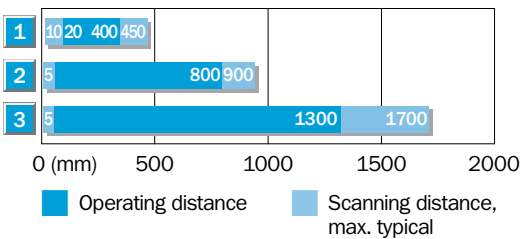

- 1** Scanning range on black, 6 % remission
- 2** Scanning range on grey, 18 % remission
- 3** Scanning range on white, 90 % remission

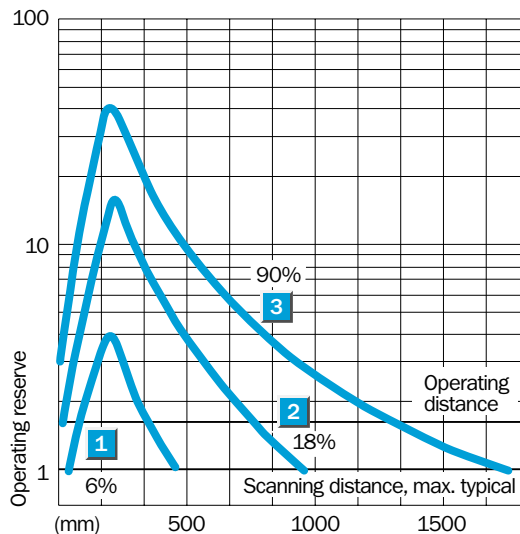



Scanning range
 0.01...14 m

Photoelectric reflex switches

- Polarising filter providing reliable detection even of objects with reflective surfaces
- Adjustable sensitivity
- Terminal chamber or M 12, 4-pin plug
- Test input

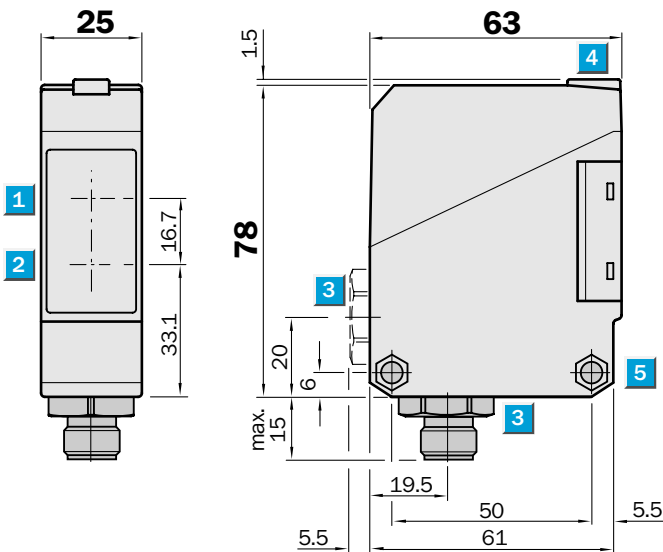
Dimensional drawing



Adjustments possible

WL 260-F 270
WL 260-F 470
WL 260-E 270

- 1 Centre of optical axis, receiver
- 2 Centre of optical axis, sender
- 3 Cable entry gland 1/2" PF thread for cable diameters from 6 to 10 mm optionally at bottom or rear; or M 12 equipment plug, bottom
- 4 LED signal strength indicator, yellow, switching output active
- 5 Through hole Ø 5.2 mm on both sides for M 5 hex nut
- 6 Sensitivity adjustment
- 7 Light/dark rotary switch
L.ON = light-switching, D.ON = dark-switching
- 8 Terminals

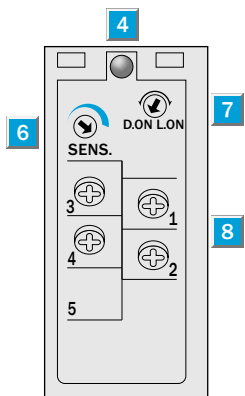

Connection types

WL 260-F 270	WL 260-F 470
WL 260-E 270	

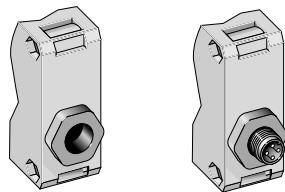

Terminals 4-pin, M 12

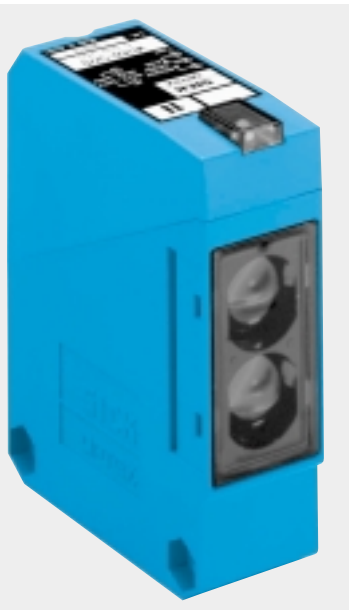
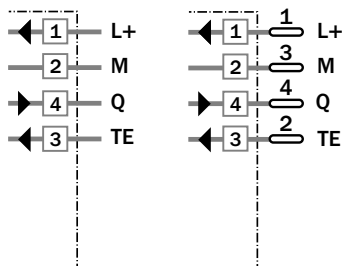

Accessories	page
Cable receptacles	496
Mounting brackets*	510
Reflector P 250*	520

* included with delivery

Technical data		WL 260-	F 270	F 470	E 270
Scanning range , max. typical/on refl.	0.01...14 m/PL 80 A				
	max. typical/on refl. 0.01...9.5 m/P 250 (included)				
Operating range	0.01...8 m/P 250				
Sensitivity	Adjustable, potentiometer 270°				
Light source¹⁾, light type	LED, visible red light with polarising filter				
Light spot diameter	Approx. 240 mm at 8 m				
Angle of dispersion, sender	Approx. 1.7°				
Supply voltage V_s	10...30 V DC ²⁾				
Ripple ³⁾	≤ 5 V _{SS}				
Current consumption ⁴⁾	≤ 35 mA				
Switching outputs	PNP, open collector: Q NPN, open collector: Q				
Output current I _A max.	100 mA				
Light receiver, switching mode	Light /dark-switching by rotary switch				
Response time ⁵⁾	≤ 1.5 ms				
Max. switching frequency ⁶⁾	333/s				
Test input "TE" sender off	PNP: TE to + V _s NPN: TE to 0 V				
Connection types	Terminal chamber M 12 plug, 4-pin				
VDE protection class⁷⁾	□				
Circuit protection⁸⁾	A, B, C, D				
Enclosure rating	IP 67				
Ambient temperature T_A	Operation - 25 °C...+ 55 °C Storage - 40 °C...+ 70 °C				
Weight	Approx. 120 g				
Material	Housing: ABS; optics: PMMA				

- 1) Average service life 100,000 h at T_A = +25 °C
- 2) Limit values
- 3) Must be within V_s tolerances
- 4) Without load
- 5) With resistive load
- 6) With light/dark ratio 1:1
- 7) Reference voltage 50 V DC
- 8) A = V_s connections reverse-polarity protected
B = Inputs/outputs reverse-polarity protected
C = Interference suppression
D = Outputs overcurrent and short-circuit protected

Scanning range and operating reserve

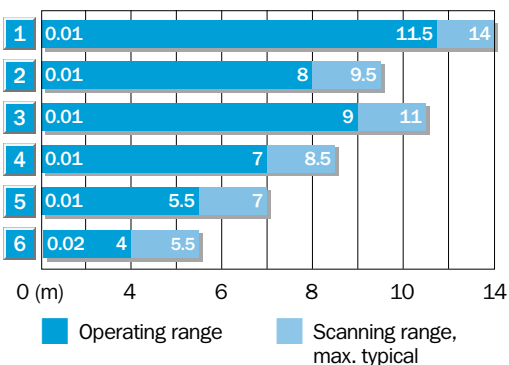

Reflector type	Operating range
1 PL 80 A	0.01...11.5 m
2 P 250	0.01...8.0 m
3 PL 50 A or PL 40 A	0.01...9.0 m
4 PL 30 A or PL 31 A	0.01...7.0 m
5 PL 20 A	0.01...5.5 m
6 Reflective tape «Diamond Grade»	0.02...4.0 m

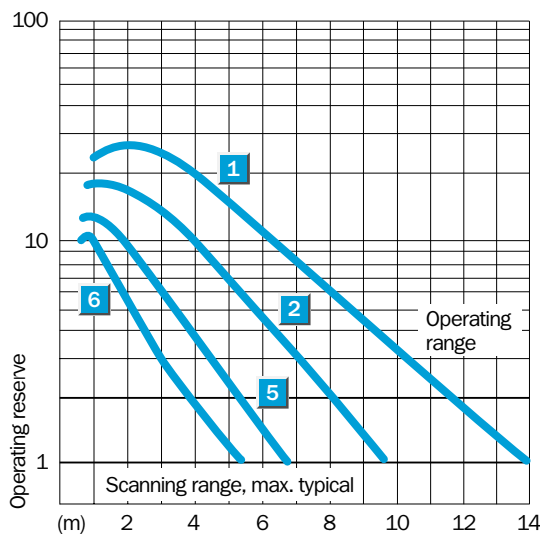

Order information

Type	Part no.
WL 260-F 270	6 020 976
WL 260-F 470	6 020 977
WL 260-E 270	6 020 978

Scanning range
0.01...15 m

Photoelectric reflex switches

- Polarising filter providing reliable detection even of objects with reflective surfaces
- Terminal chamber
- Universal current supply, relay output, SPDT, timer optional, t_{ON} and t_{OFF} can be connected separately
- Enclosure rating IP 67
- CE noise radiation EN 50081-1 ("Residential standard")

Dimensional drawing

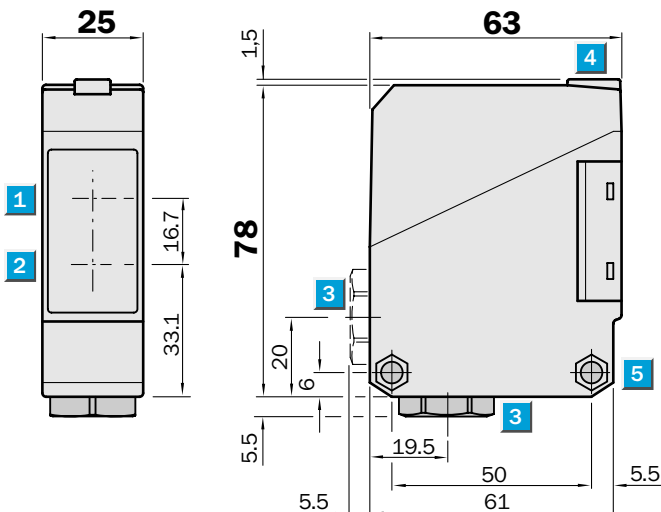

Adjustments possible

WL 260-S 270 WL 260-R 270

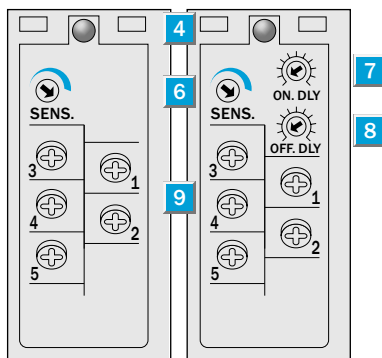

- 1 Centre of optical axis, receiver
- 2 Centre of optical axis, sender
- 3 Cable entry gland 1/2" PF thread for cable diameters from 6 to 10 mm optionally at bottom or rear
- 4 LED signal strength indicator, red
- 5 Through hole \varnothing 5.2 mm on both sides for M 5 hex nut
- 6 Sensitivity adjustment
- 7 Time control ON-delay t_{ON}
- 8 Time control OFF-delay t_{OFF}
- 9 Terminals

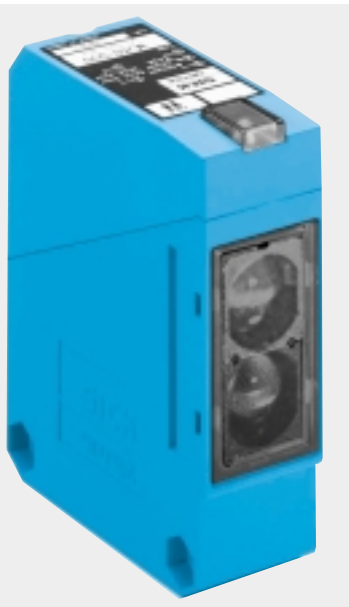

Connection type

WL 260-S 270
WL 260-R 270

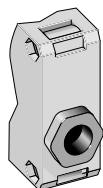

Terminals

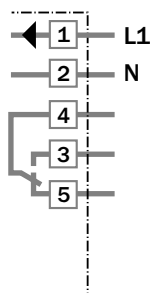

Time delay

$t = 0.1 - 10 \text{ s}$

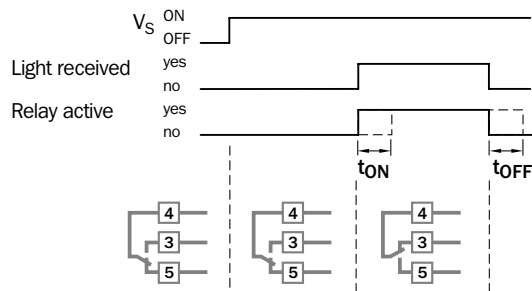

Accessories	page
Mounting brackets*	510
Reflector P 250*	520

* included with delivery

Technical data		WL 260-	S 270	R 270									
Scanning range , max. typical/on refl.	0.01...15 m/ PL 80 A												
	max. typical/on refl. 0.01...11 m/P 250 (included)												
Operating range	0.01...10 m/P 250												
Sensitivity	Adjustable, potentiometer 270°												
Light source¹⁾, light type	LED, visible red light												
	with polarising filter												
Light spot diameter	Approx. 300 mm at 10 m												
Angle of dispersion, sender	Approx. 1.7°												
Supply voltage V_s²⁾	12...240 V DC												
	24...240 V AC												
Power consumption	≤ 5 VA												
Switching output	Relay, SPDT, electrically isolated												
Switching current I_A max. ³⁾	3 A/240 V AC; 3 A/30 V DC												
Light receiver, switching mode	Light-switching												
Response time	≤ 20 ms												
Max. switching frequency ⁴⁾	25/s												
Time delays													
ON delay t_{ON}	0.1...10 s, can be connected separately												
OFF delay t_{OFF}	0.1...10 s, can be connected separately												
Connection type	Terminal chamber												
CE noise radiation	Level EN 50081-1												
	("Residential standard")												
VDE protection class⁵⁾	□												
Circuit protection⁶⁾	A, C												
Enclosure rating	IP 67												
Ambient temperature T_A	Operation - 25 °C...+ 55 °C												
	Storage - 40 °C...+ 70 °C												
Weight	Approx. 120 g												
Material	Housing: ABS; optics: PMMA												

1) Average service life 100,000 h at $T_A = + 25 °C$
 2) ± 10 %

3) Provide suitable spark suppression for inductive or capacitive loads
 4) With light/dark ratio 1:1

5) Reference voltage 250 V UC
 6) A = V_s connections reverse-polarity protected
 C = Interference suppression

Scanning range and operating reserve

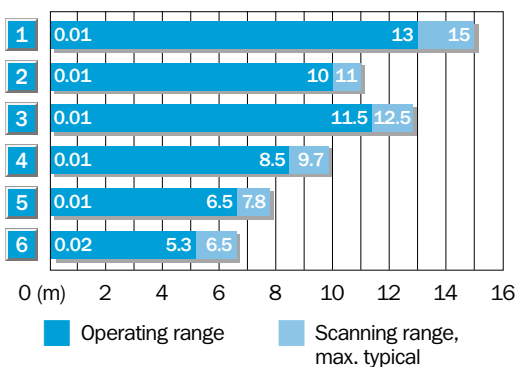

Reflector type	Operating range
1 PL 80 A	0.01...13.0 m
2 P 250	0.01...10.0 m
3 PL 50 A or PL 40 A	0.01...11.5 m
4 PL 30 A or PL 31 A	0.01...8.5 m
5 PL 20 A	0.01...6.5 m
6 Reflective tape «Diamond Grade»	0.01...5.3 m

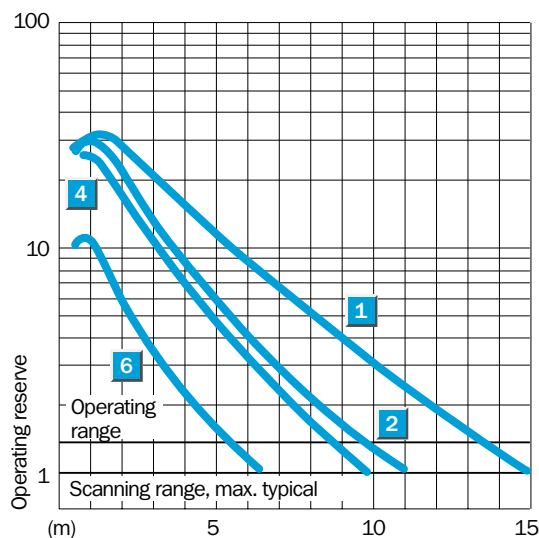

Order information

Type	Part no.
WL 260-S 270	6 020 767
WL 260-R 270	6 020 768

Scanning range
30 m

Through-beam photoelectric switches

- Adjustable sensitivity
- Terminal chamber or M 12, 4-pin plug
- Test input



Dimensional drawing

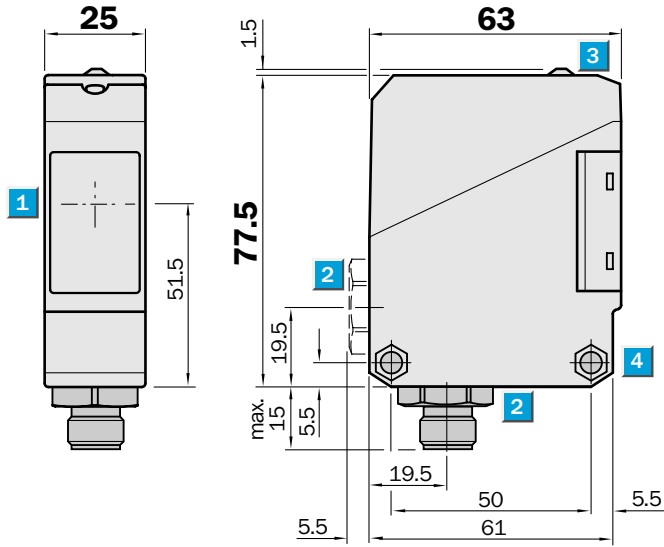

Adjustments possible

- WS/WE 260-F 230
- WS/WE 260-F 430
- WS/WE 260-E 230

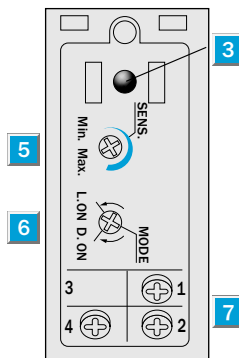

- 1 Centre of optical axis, sender/receiver
- 2 Cable entry gland 1/2" PF thread for cable diameters from 6 to 10 mm optionally at bottom or rear; or M 12 equipment plug, bottom
- 3 LED signal strength indicator, red
- 4 Through hole \varnothing 5.2 mm on both sides for M 5 hex nut
- 5 Sensitivity adjustment
- 6 Light/dark rotary switch
L.ON = light-switching, D.ON = dark-switching
- 7 Terminals

Connection types

- WS/WE 260-F 230
- WS/WE 260-F 430
- WS/WE 260-E 230

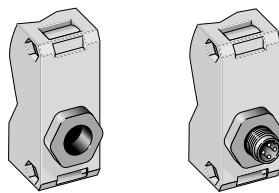

Terminals	4-pin, M 12
WS 260-G 230	WS 260-G 430

Sender

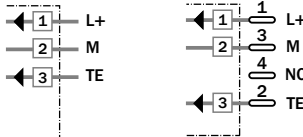

Receiver

WE 260-E 230	WE 260-F 430
WE 260-F 230	

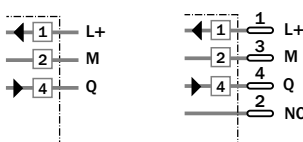

Accessories	page
Cable receptacles M 12	496
Mounting brackets*	510
Slotted masks	556

* included with delivery



Technical data		WS/WE 260-	F 230	F 430	E 230
Scanning range, max. typical	30 m				
Operating range	20 m				
Sensitivity	Adjustable, potentiometer 270°				
Light source¹⁾, light type	LED, infrared light				
Light spot diameter	Approx. 350 mm at 20 m				
Angle of dispersion, sender	Approx. 1°				
Angle of dispersion, receiver	Approx. 20°				
Supply voltage V_S	10...30 V DC ²⁾				
Ripple ³⁾	≤ 5 V _{SS}				
Current consumption ⁴⁾					
sender	≤ 20 mA				
receiver	≤ 35 mA				
Switching outputs	PNP, open collector: Q NPN, open collector: Q				
Output current I _A max.	100 mA				
Light receiver, switching mode	Light-/dark-switching by rotary switch				
Response time ⁵⁾	≤ 1 ms				
Max. switching frequency ⁶⁾	500/s				
Test input "TE" sender off	PNP, NPN: TE to 0 V				
Connection types	Terminal chamber M 12 plug, 4 pin				
VDE protection class⁷⁾	□				
Circuit protection⁸⁾					
sender	A, B				
receiver	A, B, C, D				
Enclosure rating	IP 66				
Ambient temperature T_A	Operation - 25 °C...+ 55 °C Storage - 40 °C...+ 70 °C				
Weight	Approx. 120 g				
Material	Housing: ABS; optics: PC				

- 1) Average service life 100000 h at T_A = + 25 °C
- 2) Limit values
- 3) Must be within V_S tolerances
- 4) Without load
- 5) With resistive load
- 6) With light/dark ratio 1:1
- 7) Reference voltage 50 V DC
- 8) A = V_S connections reverse-polarity protected
B = Inputs/outputs reverse-polarity protected
- C = Interference suppression
D = Outputs overcurrent and short-circuit protected

Scanning range and operating reserve

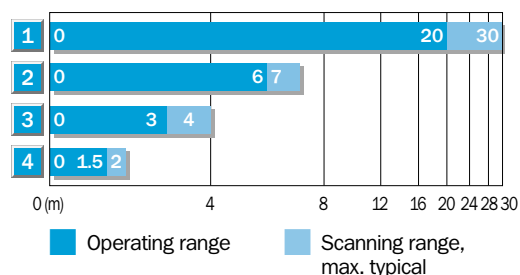

Scanning range reduction when using slotted masks

1	Without slotted mask
2	Slot width 5 mm
3	Slot width 2 mm
4	Slot width 1 mm

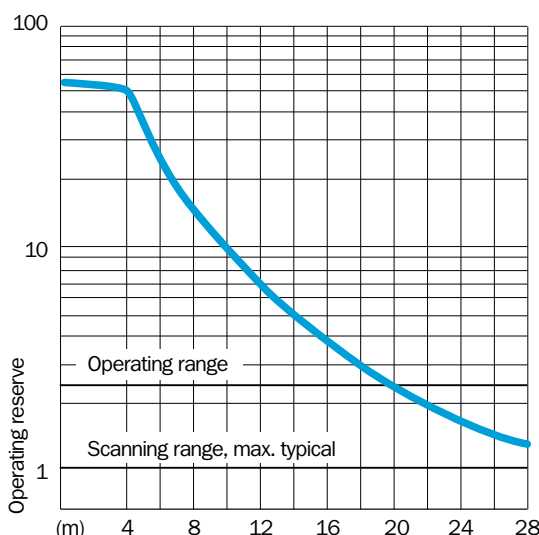

Order information

Type	Part no.
WS/WE 260-F 230	6 020 052
WS/WE 260-E 230	6 020 051
WS/WE 260-F 430	6 020 053

Scanning range
45 m

Through-beam photoelectric switches

- Adjustable sensitivity
- Terminal chamber
- Universal current supply, relay output, SPDT, timer optional, t_{ON} and t_{OFF} can be connected separately
- Enclosure rating IP 67
- CE noise radiation EN 50081-1 ("Residential standard")

Dimensional drawing

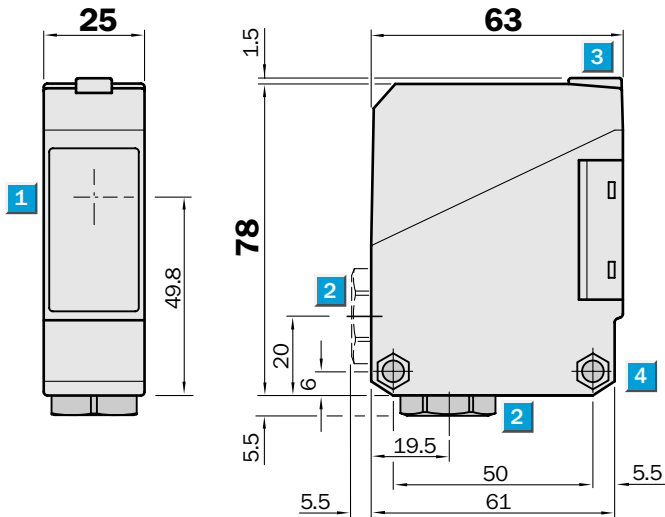

Adjustments possible

WS/WE 260-S 270 WS/WE 260-R 270

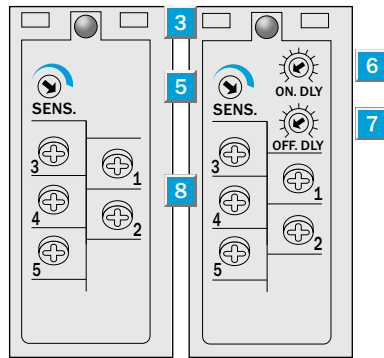

- 1 Centre of optical axis, sender and receiver
- 2 Cable entry gland 1/2" PF thread for cable diameters from 6 to 10 mm optionally at bottom or rear
- 3 LED signal strength indicator, red
- 4 Through hole \varnothing 5.2 mm on both sides for M 5 hex nut
- 5 Sensitivity adjustment
- 6 Time control ON-delay t_{ON}
- 7 Time control OFF-delay t_{OFF}
- 8 Terminals



Connection type

WS/WE 260-S 270
WS/WE 260-R 270

Time delay

$t = 0.1 - 10 \text{ s}$

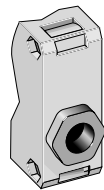
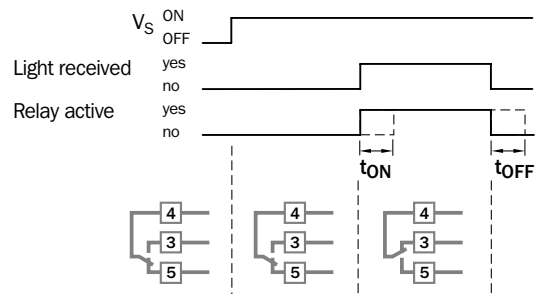

Terminals

WS 260-S 270

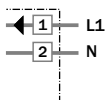

Sender

WE 260-S 270

WE 260-R 270

Receiver

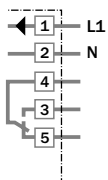

Accessories	page
Mounting brackets*	510

* included with delivery

Technical data		WS/WE 260-	S 270	R 270								
Scanning range , max. typical	45 m											
Operating range	40 m											
Sensitivity	Adjustable, potentiometer 270°											
Light source¹⁾, light type	LED, visible red light											
Light spot diameter	Approx. 700 mm at 40 m											
Angle of dispersion, sender	Approx. 1°											
Angle of dispersion, receiver	Approx. 20°											
Supply voltage V_S²⁾	12...240 V DC											
	24...240 V AC											
Power consumption												
Sender	≤ 4 VA											
Receiver	≤ 5 VA											
Switching output	Relay, SPDT, electrically isolated											
Switching current I _A max. ³⁾	3 A/240 V AC; 3 A/30 V DC											
Light receiver, switching mode	Light-switching											
Response time	≤ 20 ms											
Max. switching frequency ⁴⁾	25/s											
Time delays												
ON-delay t _{ON}	0.1...10 s, can be connected separately											
OFF-delay t _{OFF}	0.1...10 s, can be connected separately											
Connection type	Terminal chamber											
CE noise radiation	Level EN 50081-1 ("Residential standard")											
VDE protection class⁵⁾	□											
Circuit protection⁶⁾	A, C											
Enclosure rating	IP 67											
Ambient temperature T_A	Operation - 25 °C...+ 55 °C Storage - 40 °C...+ 70 °C											
Weight	Approx. 120 g											
Material	Housing: ABS; optics: PC											

1) Average service life 100,000 h at T_A = + 25 °C
2) ± 10 %

3) Provide suitable spark suppression for inductive or capacitive loads
4) With light/dark ratio 1:1

5) Reference voltage 250 V UC
6) A = V_S connections reverse-polarity protected
C = Interference suppression

Scanning range and operating reserve

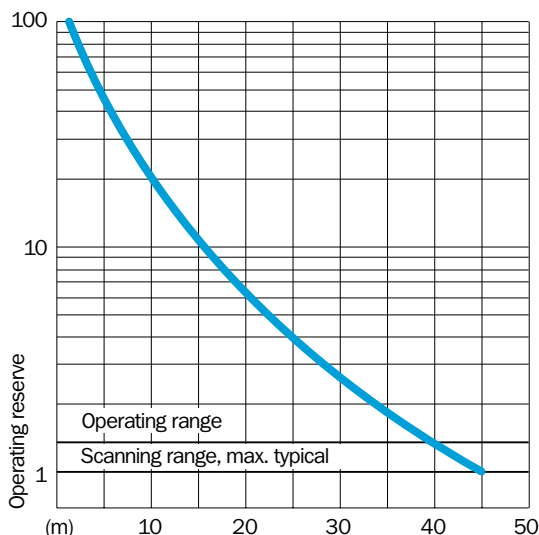
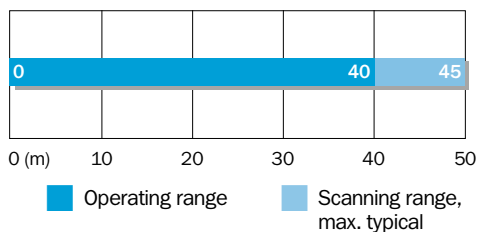

Order information

Type	Part no.
WS/WE 260-S 270	6 020 773
WS/WE 260-R 270	6 020 774

	Scanning range max. 800 mm
Through-beam systems	
	Scanning distance max. 65 (110) mm
Proximity systems	

- Wide range of fibre-optic cables for through-beam and proximity applications
- Easy adaption of fibre-optic cable using cap nut
- Adjustable sensitivity
- Terminal chamber, at bottom or rear or M 12 plug, 4-pin
- Test input

Dimensional drawing

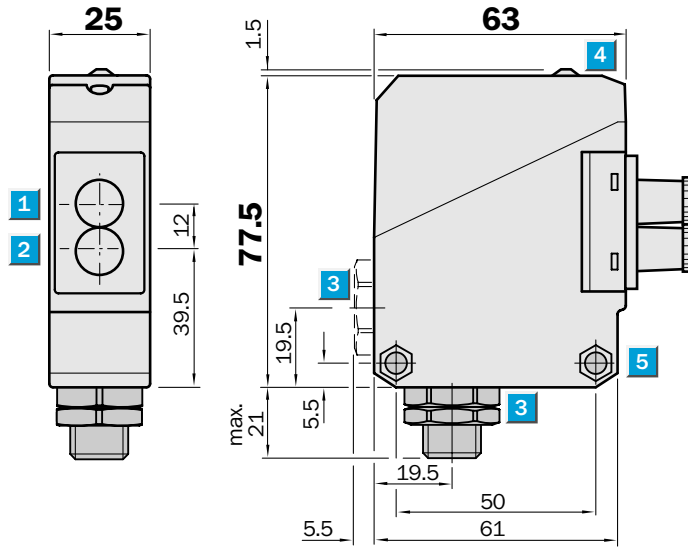

Adjustments possible

WLL 260-F 240
WLL 260-F 440
WLL 260-E 240

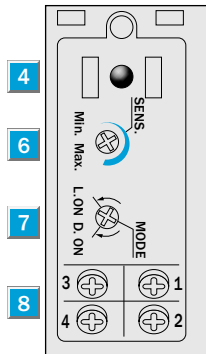

- 1** Centre of optical axis, receiver
- 2** Centre of optical axis, sender
- 3** Cable entry gland 1/2" PF thread for cable diameters from 6 to 10 mm optionally at bottom or rear; or M 12 equipment plug, bottom
- 4** LED signal strength indicator, red
- 5** Through hole \varnothing 5.2 mm on both sides for M 5 hex nut
- 6** Sensitivity adjustment
- 7** Light/dark rotary switch
L.ON = light-switching, D.ON = dark-switching
- 8** Terminals

Connection types

WLL 260-E 240	WLL 260-F 440
WLL 260-F 240	

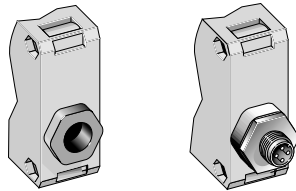

Terminals	4-pin, M 12
------------------	-------------

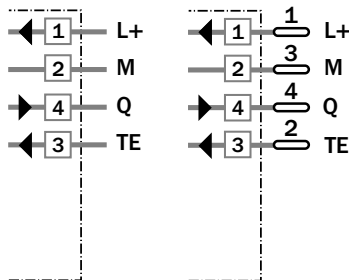

Accessories	page
Cable receptacles	496
Mounting brackets*	510
Fibre-optic cable	528

* included with delivery

Technical data		WLL 260-	F 240	F 440	E 240						
Suitable fibre-optic cables	Fibre-optic cable series LIS/LBS see page 552										
Scanning distance/ranges	Depends on the fibre-optic cable used										
Through-beam system											
Scanning distance, max. typical ¹⁾	0...65 mm										
	0...110 mm w. special fibre-optic cable										
Scanning range ¹⁾	0...50 mm										
	0...90 mm w. special fibre-optic cable										
Proximity system											
Scanning range, max. typical	0...800 mm										
Operating range	0...700 mm										
Sensitivity	Adjustable, potentiometer 270°										
Light source²⁾, light type											
Light source ²⁾ , light type	LED, visible red light										
Light spot diameter	Depends on scanning range										
Aperture fibre-optic cable	Approx. 65°										
Supply voltage V_S											
Supply voltage V _S	10...30 V DC ³⁾										
Ripple ⁴⁾	≤ 5 V _{SS}										
Current consumption ⁵⁾	≤ 35 mA										
Switching outputs											
Switching outputs	PNP, open collector: Q NPN, open collector: Q										
Output current I _A max.	100 mA										
Light receiver, switching mode	Light-/dark-switching by rotary switch										
Response time ⁶⁾	≤ 0.7 ms										
Max. switching frequency ⁷⁾	700/s										
Test input "TE" sender off											
Test input "TE" sender off	PNP: TE to + V _S NPN: TE to 0 V										
Connection types											
Connection types	Terminal chamber Plug M 12, 4-pin										
VDE protection class⁸⁾	□										
Circuit protection⁹⁾	A, B, C, D										
Enclosure rating	IP 66										
Ambient temperature T_A											
Ambient temperature T _A	Operation -25 °C...+55 °C Storage -40 °C...+70 °C										
Weight	Approx. 120 g										
Material	Housing: ABS										

1) Object with 90 % remission (based on standard white DIN 5033)
 2) Average service life 100,000 h at T_A = +25 °C
 3) Limit values
 4) Must be within V_S tolerances

5) Without load
 6) With resistive load
 7) With light/dark ratio 1:1
 8) Reference voltage 50 V DC

9) A = V_S connections reverse-polarity protected
 B = Inputs/outputs reverse-polarity protected
 C = Interference suppression
 D = Outputs overcurrent and short-circuit protected

Order information	
Type	Part no.
WLL 260-F 240	6 020 064
WLL 260-F 440	6 020 065
WLL 260-E 240	6 020 063

	Scanning range max. 800 mm
Through-beam systems	
	Scanning distance max. 65 (110) mm
Proximity systems	

- Wide range of fibre-optic cables for through-beam and proximity applications
- Easy adaption of fibre-optic cable using cap nut
- Adjustable sensitivity
- Terminal chamber, at bottom or rear
- Universal current supply, relay output, SPST, timer optional

Dimensional drawing

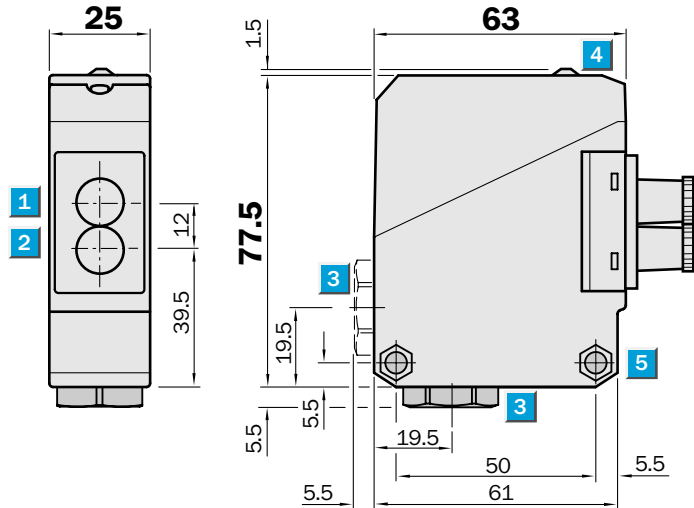

Adjustments possible

WLL 260-S 240 WLL 260-R 240

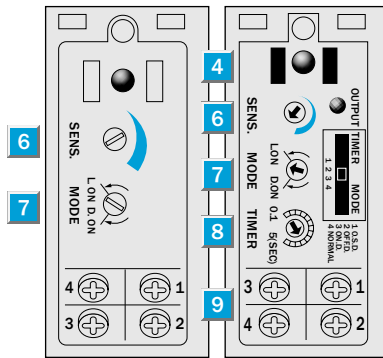

- 1** Centre of optical axis, receiver
- 2** Centre of optical axis, sender
- 3** Cable entry gland 1/2" PF thread for cable diameters from 6 to 10 mm optionally at bottom or rear
- 4** LED signal strength indicator, red
- 5** Through hole \varnothing 5.2 mm on both sides for M 5 hex nut
- 6** Sensitivity adjustment
- 7** Light/dark rotary switch
L.ON = light-switching,
D.ON = dark-switching
- 8** Time range control
- 9** Terminals
- 1 0** Red LED status indicator, switching output active
- 1 1** Time delay selector switch
O.S.D. = One Shot
OFF.D. = OFF delay
ON.D. = ON delay
Normal = No delay



Connection type

WLL 260-S 240
WLL 260-R 240

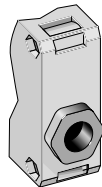

Terminals

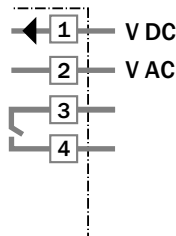

Accessories	page
Mounting brackets*	510
Fibre-optic cable	528

* included with delivery

Time delay

t = 0.1 - 5 s

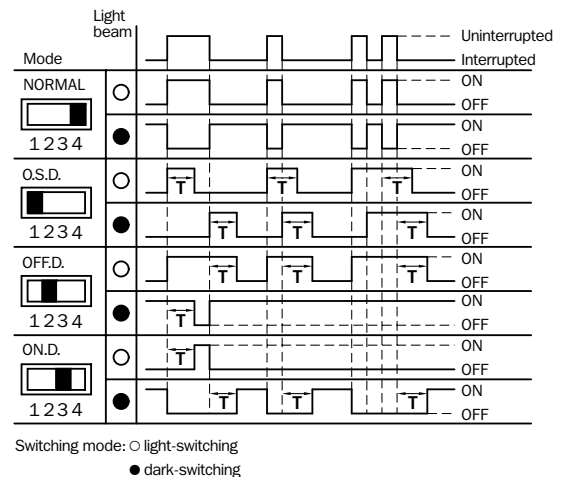

Technical data		WLL 260-	S 240	R 440								
Suitable fibre-optic cable	Fibre-optic cable series LIS/LBS see page 552											
Scanning distance/ranges	Depends on the fibre-optic cable used											
Through-beam system												
Scanning distance, max. typical ¹⁾	0...65 mm											
	0...110 mm w. special fibre-optic cable											
Scanning range ¹⁾	0...50 mm											
	0...90 mm w. special fibre-optic cable											
Proximity system												
Scanning range, max. typical	0...800 mm											
Operating range	0...700 mm											
Sensitivity	Adjustable, potentiometer 270°											
Light source²⁾, light type												
Light source ²⁾ , light type	LED, visible red light											
Light spot diameter	Depends on scanning range											
Aperture fibre-optic cable	Approx. 65°											
Supply voltage V_S³⁾												
Supply voltage V _S ³⁾	12...240 V DC											
	24...240 V AC											
Power consumption	≤ 5 VA											
Switching output												
Switching output	Relay, SPST, electrically isolated											
Switching current I _A max. ⁴⁾	3 A/240 V AC; 3 A/30 V DC											
Light receiver, switching mode	Light /dark-switching by rotary switch											
Response time	≤ 20 ms											
Max. switching frequency ⁵⁾	25/s											
Time delays												
Time delays	With indicator LED: switching output active											
Switch position: «1 O.S.D.»	1: «One shot»											
«2 OFF.D.»	OFF delay t _{OFF}											
«3 ON.D.»	ON delay t _{ON}											
«4 Normal»	No delay											
Time range												
Time range	Adjustable, 0.1...5 s; potentiometer 270°											
Connection type												
Connection type	Terminal chamber											
VDE protection class⁶⁾												
VDE protection class ⁶⁾	□											
Circuit protection⁷⁾												
Circuit protection ⁷⁾	A, C											
Enclosure rating												
Enclosure rating	IP 66											
Ambient temperature T_A												
Ambient temperature T _A	Operation -25 °C...+55 °C											
	Storage -40 °C...+70 °C											
Weight												
Weight	Approx. 120 g											
Material												
Material	Housing: ABS											

1) Object with 90 % remission (based on standard white DIN 5033)
2) Average service life 100,000 h at T_A = +25 °C

3) ± 10 %
4) Provide suitable spark suppression for inductive or capacitive loads
5) With light/dark ratio 1:1

6) Reference voltage 50 V DC
7) A = V_S connections reverse-polarity protected
C = Interference suppression

Order information	
Type	Part no.
WLL 260-S 240	6 009 504
WLL 260-R 240	6 009 503