

SUBMINIATURE, HIGH SENSITIVITY PHOTOINTERRUPTER

*Features

- Compact and thin.
- Visible light cut-off type.
- High sensitivity.
- Package: 1000pcs/Reel.
- Moisture sensitivity level : level 4.
- RoHS Compliant.

*Applications

- Cassette tape recorders, VCRs.
- Floppy disk drives.
- Various microcomputerized control equipment.

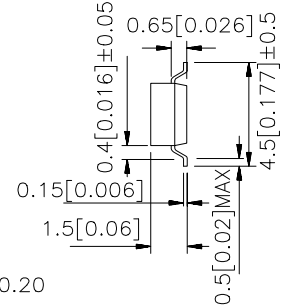
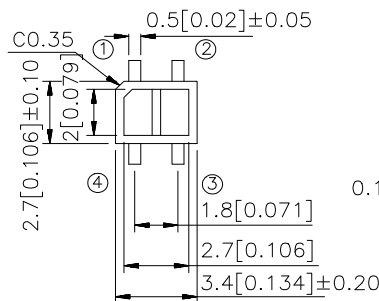

① Anode ② Emitter

③ Collector ④ Cathode

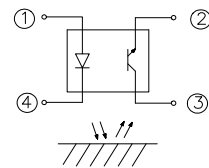

UNIT : MM[INCH]

TOLERANCE : ±0.25[± 0.01] UNLESS OTHERWISE NOTED.

*Absolute Maximum Ratings

Parameter		Symbol	Rating	Unit
Input	Forward current	I_F	50	mA
	Reverse voltage	V_R	6	V
	Power dissipation	P_D	75	mW
	Peak Forward Current (Pulse Width $\leq 100\mu\text{s}$, Duty Cycle = 1%)	I_{FP}	1	A
Output	Collector-emitter voltage	V_{CEO}	35	V
	Emitter-collector voltage	V_{ECO}	6	V
	Collector current	I_C	20	mA
	Collector power dissipation	P_C	75	mW
Operating temperature		T_{opr}	-25~+85	°C
Storage temperature		T_{stg}	-40~+100	°C
soldering temperature (1/16 inch from body for 5 seconds)		T_{sol}	260	°C



Electro-optical Characteristics

Parameter		Symbol	Conditions	Min.	TYP.	Max.	Unit	
Input	Forward Voltage	V_F	$I_F=20\text{mA}$	1.0	1.2	1.5	V	
	Reverse Current	I_R	$V_R=6\text{V}$	-	-	10	μA	
	Peak Wavelength	λ_P	$I_F=20\text{mA}$	-	940	-	nm	
Output	Collector Dark Current	I_{CEO}	$V_{CE}=20\text{V}$	-	10^{-9}	10^{-7}	A	
Transfer characteristics	*1 Collector Current	I_C	$V_{CE}=2\text{V}$ $I_F=4\text{mA}$	10	-	400	μA	
	*2 Leak Current	I_{LEAK}	$V_{CE}=2\text{V}$ $I_F=4\text{mA}$	-	-	0.1	μA	
	Response time	Rise time	t_r	$V_{CE}=2\text{V}$ $I_C=100\mu\text{A}$ $R_L=1\text{K}\Omega, d=1\text{mm}$	-	20	100	μsec
		Fall time	t_f		-	20	100	μsec

*1 The condition and arrangement of the reflective object are shown below.
 *2 Without reflective object.

Classification table of radiant flux

BIN CODE	E	F	G
I_C (μA)	10~120	100~250	200~400

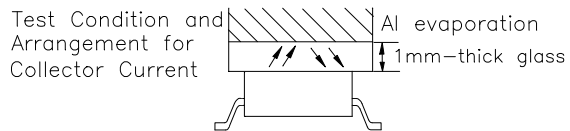

Fig. 1 Forward Current vs. Forward Voltage

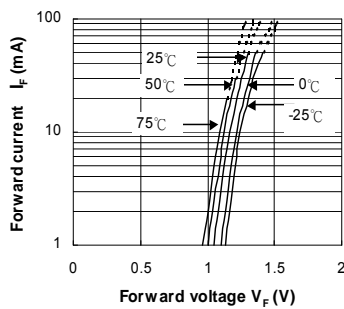

Fig. 2 Collector Current vs. Forward Current

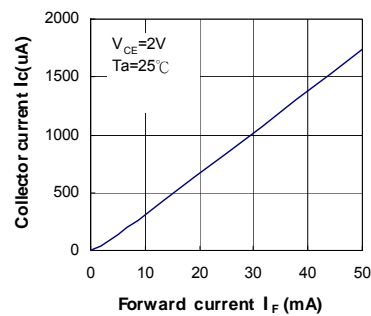

Fig. 3 Collector Current vs. Collector-emitter Voltage

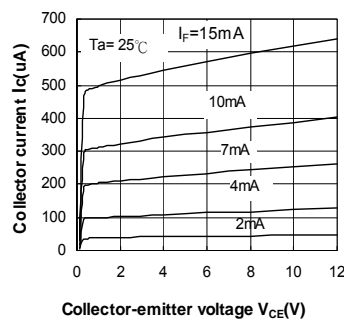

Fig. 4 Relative Collector Current vs. Ambient Temperature

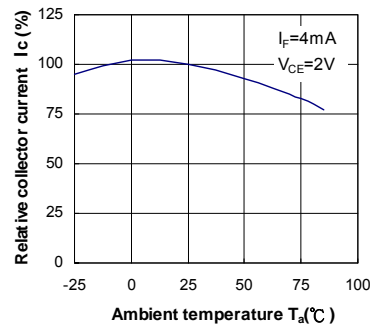
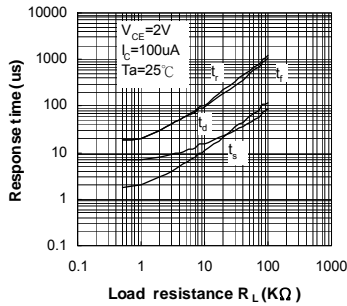

Fig. 5 Response Time vs. Load Resistance



Test Circuit for Response Time

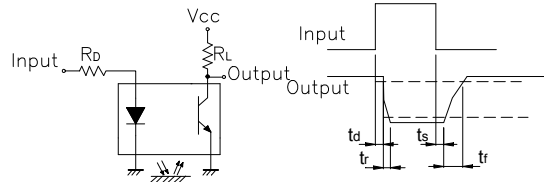

Fig. 6 Collector Dark Current vs. Ambient Temperature

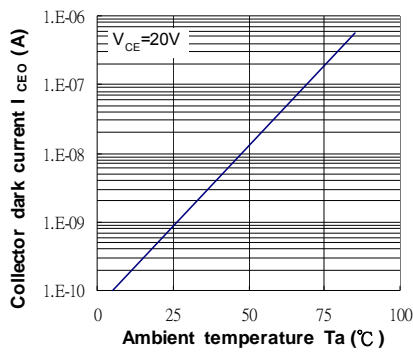

Fig. 7 Relative Collector Current vs. Distance between Sensor and Al Evaporation Glass

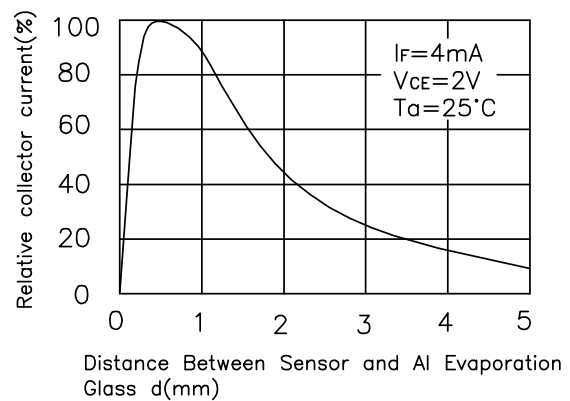

Fig. 8 Relative Collector Current vs. Card Moving Distance (1)

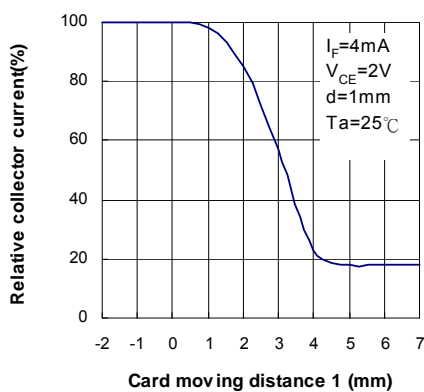
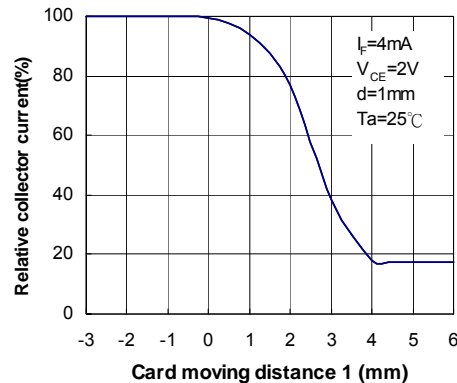

Fig. 9 Relative Collector Current vs. Card Moving Distance (2)



Test Condition for Distance & Detecting Position Characteristics

Correspond to Fig. 7



Correspond to Fig. 8
Test condition

$I_F = 4\text{mA}$
 $V_{CE} = 2\text{V}$
 $d = 1\text{mm}$

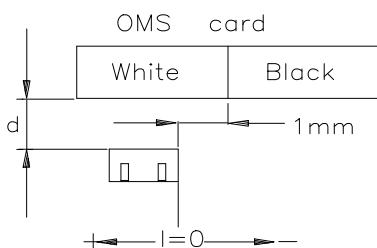

Correspond to Fig. 9
Test condition

$I_F = 4\text{mA}$
 $V_{CE} = 2\text{V}$
 $d = 1\text{mm}$

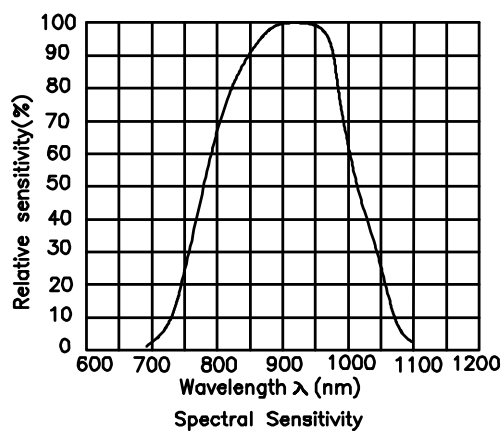
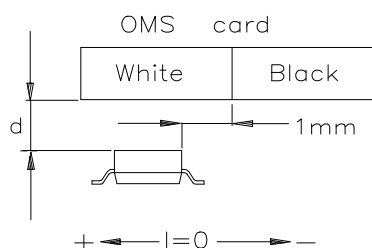

Reflow Soldering Profile For Lead-free SMT Process.

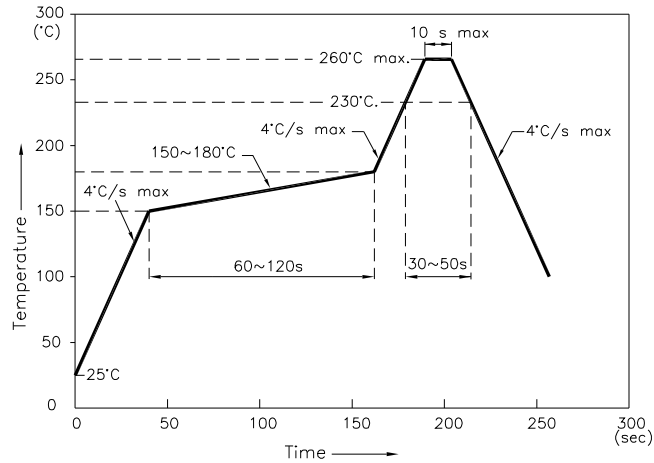

NOTES:

1. We recommend the reflow temperature 245°C(+/-5°C). The maximum soldering temperature should be limited to 260°C.
2. Don't cause stress to the epoxy resin while it is exposed to high temperature.
3. Number of reflow process shall be 2 times or less.

**Recommended Soldering Pattern
(Units : mm; Tolerance: ±0.1)**

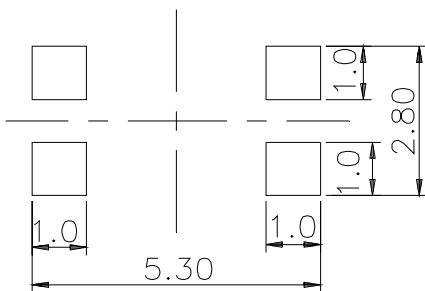

Reel Dimension

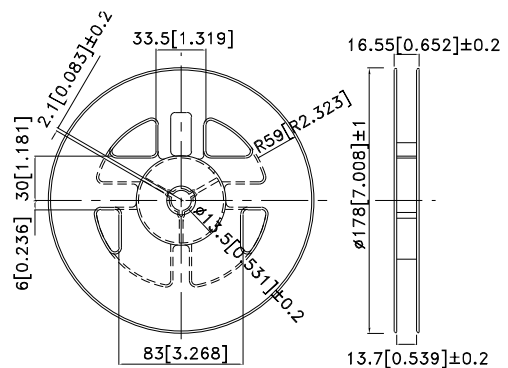

**Tape Specifications
(Units : mm)**

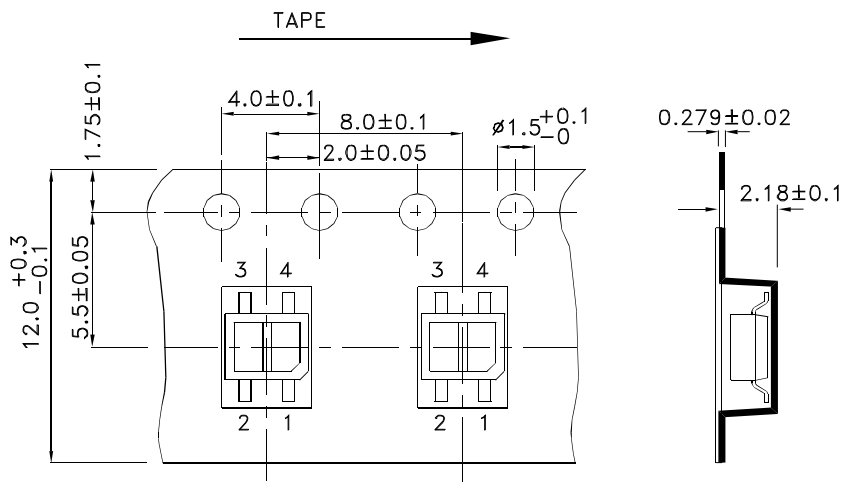

PACKING & LABEL SPECIFICATIONS

KTIR0711S

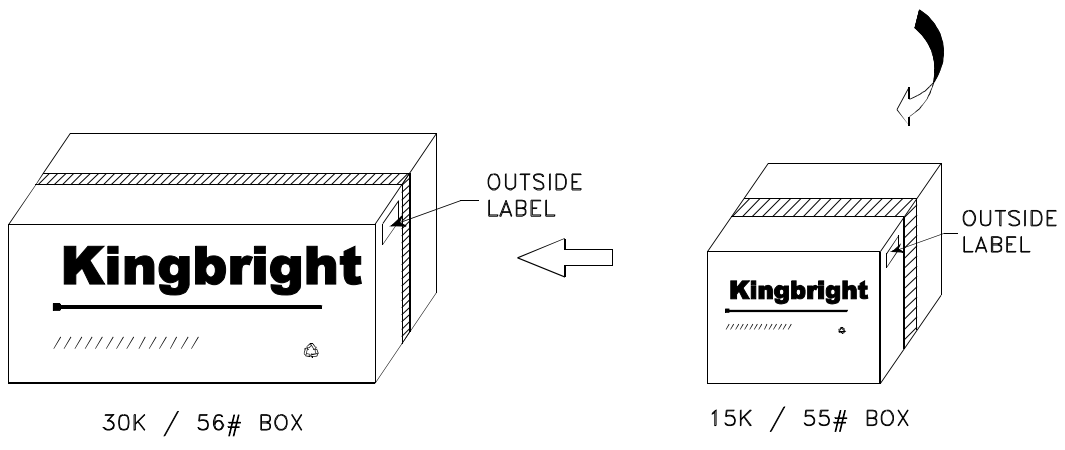
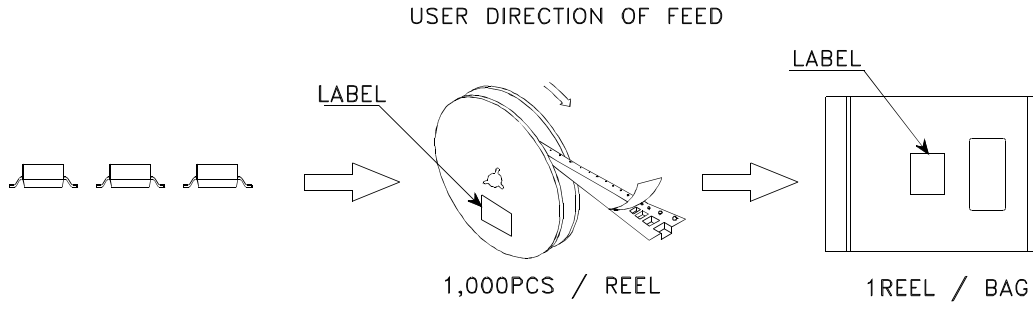

<h1>Kingbright</h1>				
P/NO: KTIRXXX				
QTY: 1,000 pcs	Q.C.			
S/N: XXXX	<table border="1"> <tr> <td>Q C</td> </tr> <tr> <td>xx xx xxxx</td> </tr> <tr> <td>PASSED</td> </tr> </table>	Q C	xx xx xxxx	PASSED
Q C				
xx xx xxxx				
PASSED				
CODE: XXX				
LOT NO:				
XXXXXXXXXXXXXXXXXX				
RoHS Compliant				