



ULTRASONIC SENSORS

ULTIMATE ULTRASONIC SENSOR SOLUTION FROM SICK

UM30, UM18, UC12, UC4

SICK
Sensor Intelligence.



VIRTUALLY UNLIMITED USE – REGARDLESS OF COLOR, SHINE, AND TRANSPARENCY

Ultrasonic sensors from SICK perform measurement and detection in a wide variety of application areas on colored, shiny, or transparent surfaces, which are particularly challenging for optical sensors. Even adverse ambient conditions such as dust, dirt, or fog hardly affect the measurement result. The broad detection range also allows a large field to be monitored with only one sensor.

For maximum reliability ...

- Maximum reliability thanks to the **advanced and intelligent analysis of measurement values**
- **Temperature compensation** right on the **active sensor surface** for more precise measurement results
- **Exceptionally simple synchronization and multiplexing** for maximum reliability, even when using multiple sensors
- Simple and reliable solution for virtually any application using the “**Distance to object**”, “**Window**”, or “**Object between sensor and background**” switching modes
- Solution for complex applications thanks to the availability of **filter settings** which can be adjusted to suit **individual applications**

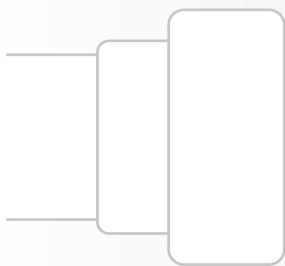

SICK also offers other technologies such as IMA inductive proximity sensors: <http://www.mysick.com/en/IMA>

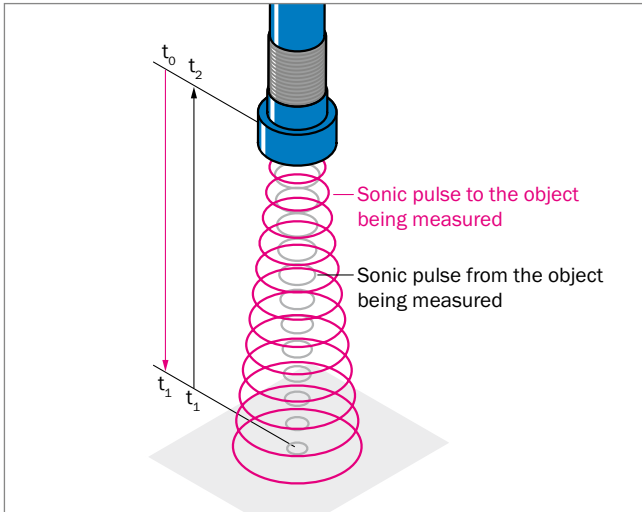

(Sonic) time-of-flight measurement

The sensor emits a sonic pulse that is reflected by the object being detected. The time required for the pulse to go from the sensor to the object and come back again is measured and evaluated and converted into the distance as follows.

$$\text{Distance} = \text{speed of sound} \times \frac{\text{total sonic time of flight } (t_2)}{2}$$

Sensing ranges of ultrasonic sensors

In general on ultrasonic sensors, the less sound the object being measured absorbs, the greater the possible sensing range. The operating range specifies the distance up to which measurement on common objects with sufficient functional reserves is possible. Under ideal conditions, the sensor can even be used up to its limiting range.

Switch panels are used for ideal assessment of application capability. The dark-blue area found on these switch panels shows the typical working range of the sensor. The light-blue area shows the maximum detection range which can be achieved under ideal conditions for easily detectable objects. This area between the sensor and the object being measured should be kept free of other objects to prevent them from being detected accidentally.

The detectability and detection range of an object depend on its reflective properties, size and alignment. Depending on the application, the sensor may also be able to detect very small objects, e.g. metal wire.

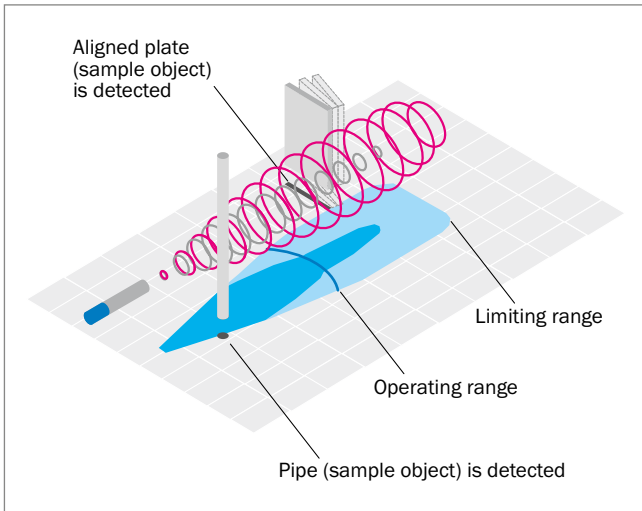

... on demanding surfaces

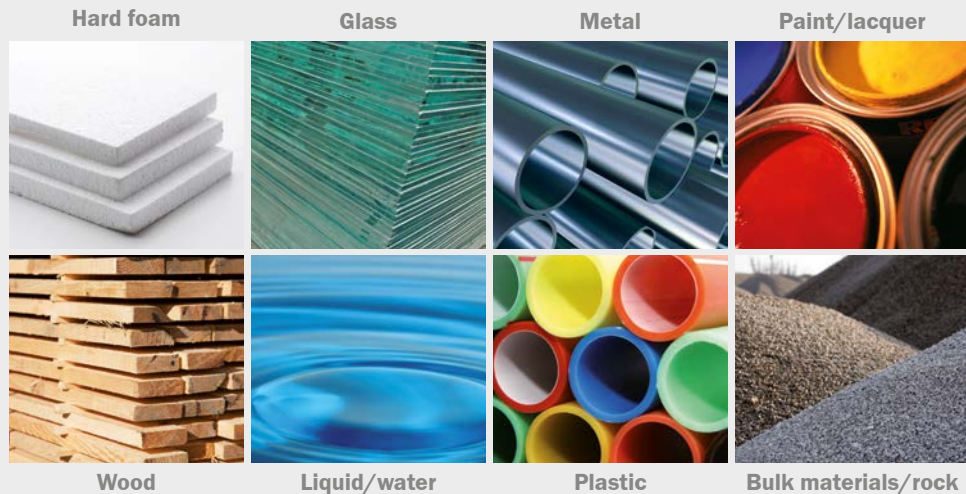

THE SUITABLE ULTRASONIC SENSOR FOR EVERY CHALLENGING APPLICATION

Ultrasonic sensors are true all-rounders. Ultrasonic sensors from SICK demonstrate their reliability and precision in virtually any application, from detecting positions to measuring distances or detecting solid, powdered, or liquid media.



The choice is yours

Every ultrasonic sensor in the SICK portfolio can handle the following applications.

Filling level control

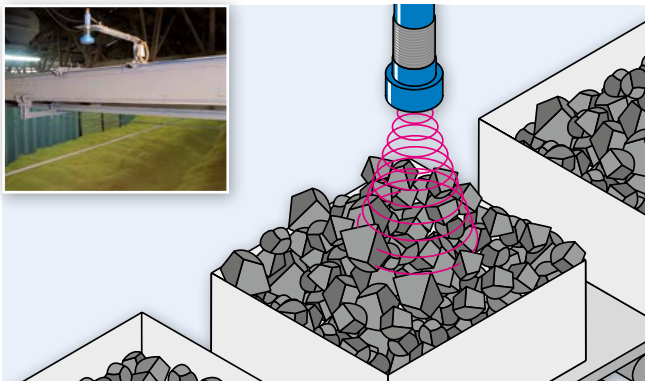

Regulating and monitoring the filling level of liquids and bulk materials ensures process reliability regardless of the material in question

Presence detection of flat objects

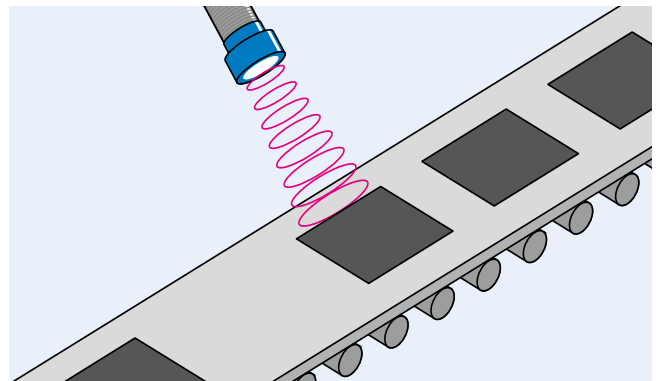

Detecting very flat objects which are difficult to detect optically using edge detection maximizes productivity

Presence detection of different objects

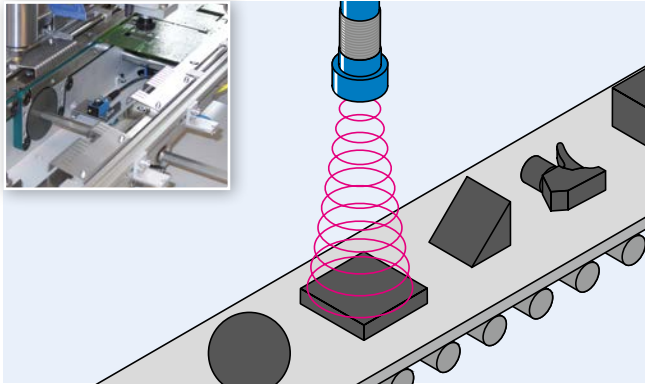

Detecting objects with different shapes and reflective properties maximizes machine flexibility

Monitoring of empty containers

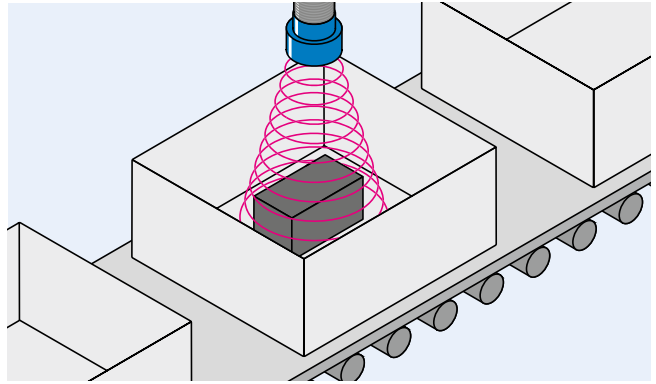

Monitoring the presence of different objects in containers increases efficiency in logistical applications

Process quality

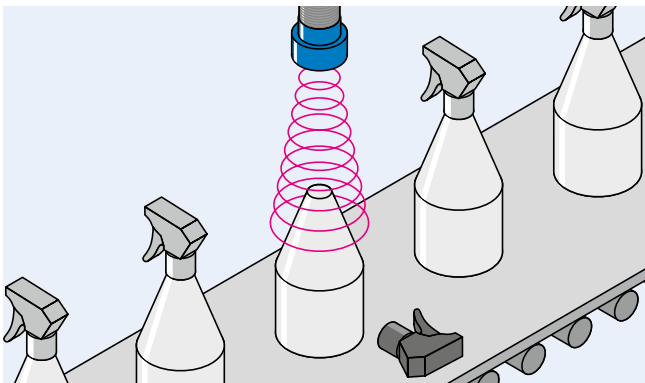

Detecting incorrectly produced or unfinished goods and incorrect alignment reduces system downtimes and ensures highest productivity

Rip detection

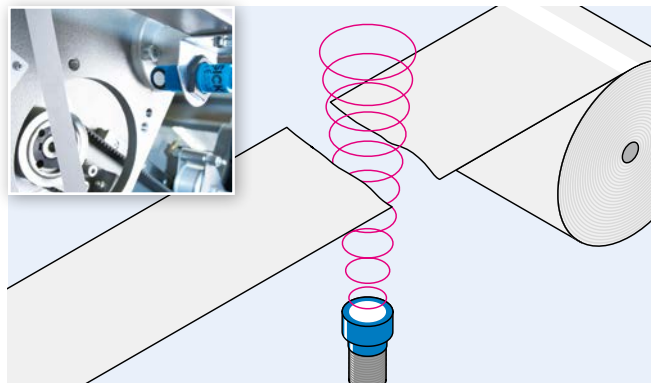

Detecting rips or tears in paper and metal rolls, films, textiles, and wires reduces system downtimes

TIP

Sonic deflection

When installation space is restricted, it is a good idea to use a deflecting plate. Ideally, the deflecting plate should be installed in the blind zone of the sensor.

This also prevents deposits accumulating on the sensor head, e.g. in dirty, oily, or humid atmospheres, which helps to optimize measurement and detection.

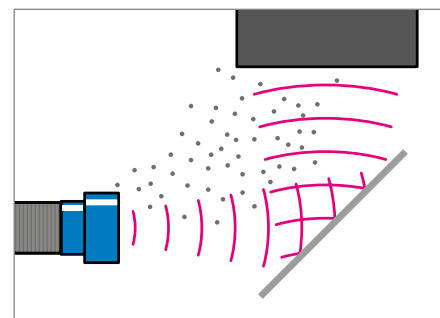



A case for all-rounders

The UM30 and UM18 really demonstrate their full potential in the following applications.

Area monitoring

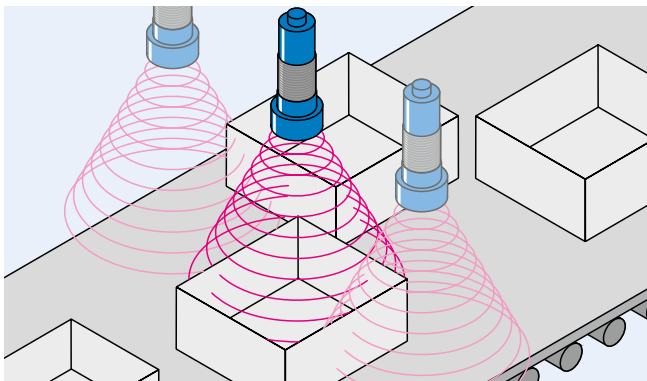

UM30 and UM18

When using multiple sensors: Implementing synchronization mode by simply connecting pin 5 increases the detection range and reduces mutual interference between the sensors. This improves the process stability.

All ultrasonic sensors from SICK

Three-dimensional detection range provides cost-effective coverage of large areas

Diameter control

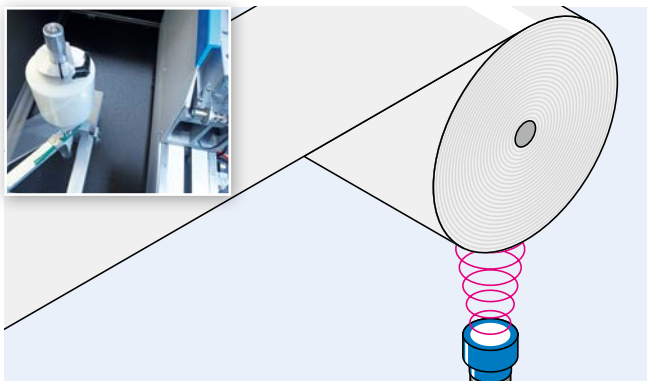

UM30 and UM18

Regulating the rolling and unrolling of different materials for the purposes of process monitoring increases system reliability

All ultrasonic sensors from SICK

As the material is unrolled, the distance between the roll and the sensor increases. When this distance exceeds a set value, the sensor outputs a signal indicating that the roll needs to be changed. This reduces the system downtime.

Dimension measurement

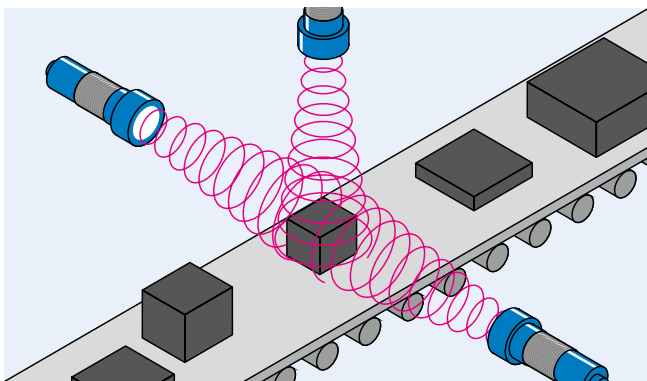

UM30 and UM18

Measuring all sorts of objects increases system flexibility. Implementing multiplex mode by simply connecting pin 5 and assigning an address in the sensor prevents mutual interference between the sensors. This guarantees maximum process stability.



Slack regulation

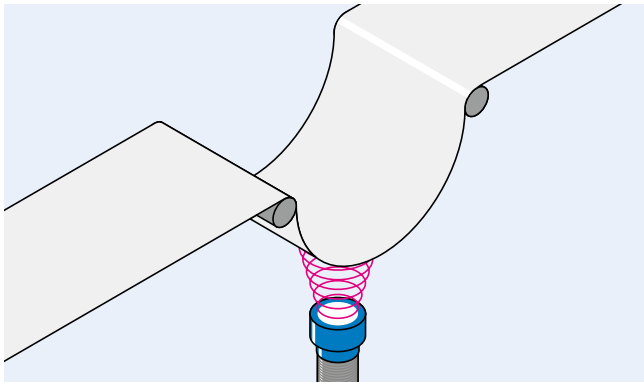

UM30 and UM18

Adjusting the material feed according to the slack depth improves the process quality

Positioning

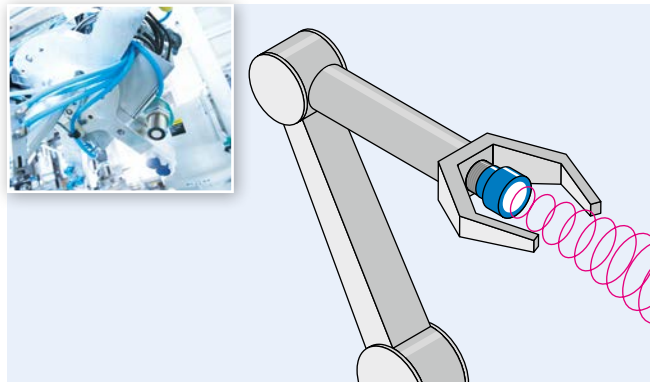

UM30 and UM18

Distance measurement for different materials ensures reliable positioning

Collision prevention

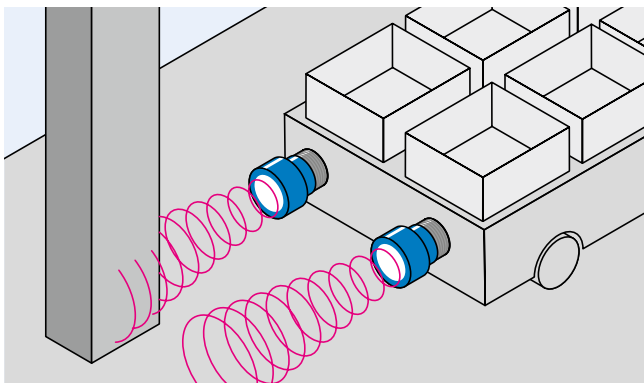



UM30 and UM18

Detecting obstructions over a large area in order to control and brake automated guided vehicle enables a high level of automation

Can't find your application?

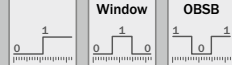

Your SICK contact partners will be happy to help you find the suitable ultrasonic sensor solution to meet your requirements. You can find contact information on the back page of this product information leaflet or at <http://www.sick.com>

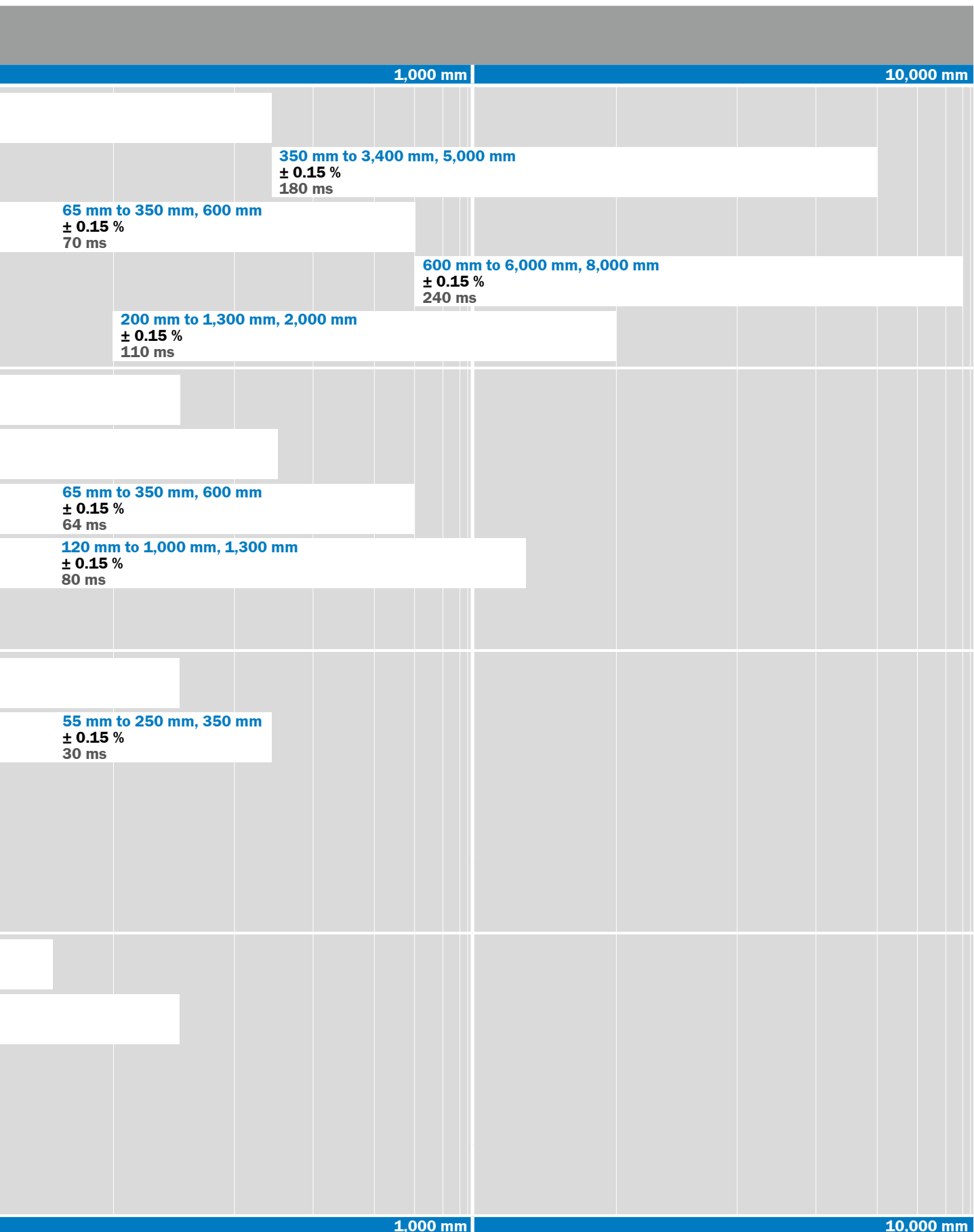

	Interfaces	Operating range, limiting range	
		10 mm	100 mm
<p>UM30</p>  <p>→ 12</p>	 		<p>30 mm to 250 mm, 350 mm ± 0.15 % 50 ms</p>
<p>UM18</p>  <p>→ 22</p>	<p>Core</p>  <p>Pro</p> 	<p>20 mm to 150 mm, 250 mm ± 0.15 % 32 ms</p>	<p>30 mm to 250 mm, 350 mm ± 0.15 % 32 ms</p>
<p>UC12</p>  <p>→ 32</p>		<p>20 mm to 150 mm, 250 mm ± 0.15 % 30 ms</p>	
<p>UC4</p>  <p>→ 38</p>		<p>13 mm to 100 mm, 150 mm ± 0.15 % 30 ms</p>	<p>13 mm to 150 mm, 250 mm ± 0.15 % 30 ms</p>
		10 mm	100 mm

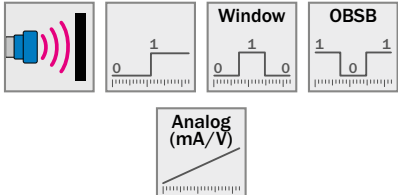
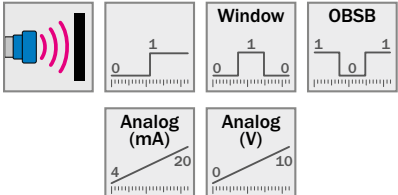

Product family overview

	 <p style="text-align: center;">UM30</p>	 <p style="text-align: center;">UM18</p>	
	The universal application solver	Simple set up, perfect detection	
Technical data overview			
Working range, limiting range	30 mm ... 250 mm, 350 mm 65 mm ... 350 mm, 600 mm 200 mm ... 1,300 mm, 2,000 mm 350 mm ... 3,400 mm, 5,000 mm 600 mm ... 6,000 mm, 8,000 mm	20 mm ... 150 mm, 250 mm 30 mm ... 250 mm, 350 mm 65 mm ... 350 mm, 600 mm 120 mm ... 1,000 mm, 1,300 mm	
Resolution	0.18 mm	0.2 mm 0.069 mm	
Repeatability	$\pm 0.15\%$	$\pm 0.15\%$	
Response time / output rate	50 ms / 8 ms 70 ms / 16 ms 110 ms / 23 ms 180 ms / 43 ms 240 ms / 60 ms	32 ms / 8 ms 32 ms / 8 ms 64 ms / 16 ms 80 ms / 20 ms	
Interfaces overview	1 x switching output and 1 x multifunctional input, 2 x switching output and 1 x multifunctional input, 1 x 4 mA ... 20 mA / 0 V ... 10 V and 1 x multifunctional input, 1 x 4 mA ... 20 mA / 0 V ... 10 V, 1 x switching output and 1 x multifunctional input	1 x switching output, 1 x push-pull switching output, IO-Link and 1 x multifunctional input, 1 x 4 mA ... 20 mA and 1 x multifunctional input, 1 x 0 V ... 10 V and 1 x multifunctional input	
Sending axis	Straight	Straight Angled	
At a glance			
	 <ul style="list-style-type: none"> • Integrated time-of-flight technology detects objects such as glass, liquids and transparent foils, independent of color • Range up to 8,000 mm • Display enables fast and flexible sensor adjustment • Immune to dust, dirt and fog • Available with combined analog and digital outputs • Synchronization and multiplexing • Adjustable sensitivity • Three operation modes: Distance to Object (DtO), Window (Wnd) or Object between sensor and background (ObSB) 	 <ul style="list-style-type: none"> • Reliable measurement independent of material color, transparency, gloss and ambient light • Four ranges up to 1,300 mm • Short metal or plastic M18 housing with a length of 41 mm • Straight or right-angle version • High immunity to dirt, dust, humidity and fog • PNP/NPN switching output, analog output or push-pull switching output with IO-Link • Synchronization and multiplex modes are available 	
Detailed information	→ 12	→ 22	



UC12

Ultrasonic technology housed in an industry-proven design



UC4

Small, precise, ultrasonic

	20 mm ... 150 mm, 250 mm 55 mm ... 250 mm, 350 mm	13 mm ... 100 mm, 150 mm 13 mm ... 150 mm, 250 mm
	0.1 mm	0.1 mm
	± 0.15 %	± 0.15 %
	30 ms / 8 ms	30 ms / 8 ms
	2 x switching output	1 x switching output
	Straight	Straight

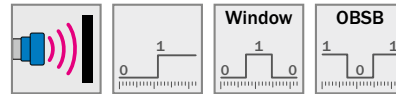
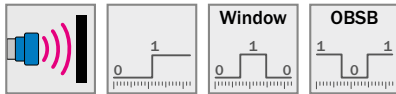

- Object detection independent of material color and ambient light – even transparent foils, glass, liquids and bottles are reliably detected
- Fast and easy teach-in with single push-button
- Immune to dirt, dust and fog
- Two ambivalent switching outputs (\bar{Q} , Q)
- Excellent background suppression
- Three operation modes: Distance to Object (DtO), Window (Wnd) or Object between sensor and background (ObSB)

- Integrated time-of-flight technology detects objects such as glass, liquids and transparent foils, independent of color
- Three operation modes: Distance to Object (DtO), Window (Wnd) or Object between sensor and background (ObSB)
- Immunity to dirt, dust and fog
- One PNP/NPN switching output
- Excellent background suppression

→ 32

→ 38

THE UNIVERSAL APPLICATION SOLVER



Analog (mA/V)

Window

OBSB



Additional information

- Detailed technical data 13
- Ordering information 14
- Dimensional drawings16
- Adjustments17
- Connection type and diagram17
- Detection areas 18
- Recommended accessories 20

Product description

The UM30 product family provides a variety of flexible options. Sensing ranges up to 8 m, as well as various setup options, enable these sensors to solve nearly any application. Its high measurement accuracy – due to internal tem-

perature compensation – along with the color-independent detection of objects, immunity to dirt and dust, and a high operational temperature range up to 70 °C, enable reliable operation – even under the most challenging conditions.

At a glance

- Integrated time-of-flight technology detects objects such as glass, liquids and transparent foils, independent of color
- Range up to 8,000 mm
- Display enables fast and flexible sensor adjustment
- Immune to dust, dirt and fog
- Available with combined analog and digital outputs
- Synchronization and multiplexing
- Adjustable sensitivity
- Three operation modes: Distance to Object (DtO), Window (Wnd) or Object between sensor and background (ObSB)

Your benefits

- Easy machine integration due to compact size
- Various setup options ensure flexible adaptation to applications
- Multiplex mode eliminates cross-talk interference for consistent and reliable detection and high measurement reliability
- Synchronization mode allows multiple sensors to work as one large sensor, providing a low-cost solution for area detection
- Display enables setup prior to installation, reducing on-site installation time
- Integrated temperature compensation and time-of-flight technology ensure high measurement accuracy
- ObSB-mode enables detection of any object between the sensor and a taught background

→ www.mysick.com/en/UM30

For more information, just enter the link or scan the QR code and get direct access to technical data, CAD design models, operating instructions, software, application examples and much more.



Detailed technical data

Performance

Working range, limiting range	30 mm ... 250 mm, 350 mm 65 mm ... 350 mm, 600 mm 200 mm ... 1,300 mm, 2,000 mm 350 mm ... 3,400 mm, 5,000 mm 600 mm ... 6,000 mm, 8,000 mm
Resolution	≤ 0.18 mm
Repeatability ¹⁾	± 0.15 %
Accuracy ^{1) 2)}	± 1 %
Temperature compensation	✓
Switching frequency	
30 mm ... 250 mm, 350 mm	11 Hz
65 mm ... 350 mm, 600 mm	8 Hz
200 mm ... 1,300 mm, 2,000 mm	6 Hz
350 mm ... 3,400 mm, 5,000 mm	3 Hz
600 mm ... 6,000 mm, 8,000 mm	2 Hz
Ultrasonic frequency (typical)	
30 mm ... 250 mm, 350 mm	320 kHz
65 mm ... 350 mm, 600 mm	400 kHz
200 mm ... 1,300 mm, 2,000 mm	200 kHz
350 mm ... 3,400 mm, 5,000 mm	120 kHz
600 mm ... 6,000 mm, 8,000 mm	80 kHz
Detection area (typical)	See diagrams
Additional function ³⁾	Set switching mode: Distance to object (DtO) / Window (Wnd) / Object between sensor and background (ObSB) Teach-in of switching output Set levels of switching outputs Switching output invertible Set on delay switching output Teach-in of analog output Scaling of analog output Invertible analog output Automatic selection of analog current or voltage output Temperature compensation Multifunctional input: synchronization / multiplexing Synchronization of up to 10 sensors Multiplexing: no cross talk of up to 10 sensors, set measurement filters: value filter, filter strength, adjustable sensitivity, foreground suppression and detection area Switch-off display Reset to factory default

¹⁾ Referring to current measurement value.

²⁾ Temperature compensation can be switched off, without temperature compensation: 0.17 % / K.

³⁾ Functions may vary depending on sensor type.

Interfaces

Resolution analog output	12 bit
Multifunctional input (MF)	1 x MF
Hysteresis	
30 mm ... 250 mm, 350 mm	3 mm
65 mm ... 350 mm, 600 mm	5 mm
200 mm ... 1,300 mm, 2,000 mm	20 mm
350 mm ... 3,400 mm, 5,000 mm	50 mm
600 mm ... 6,000 mm, 8,000 mm	100 mm

Mechanics/electronics

Supply voltage V_s ^{1) 2)}	DC 9 V ... 30 V
Power consumption ³⁾	≤ 2.4 W
Initialization time	< 300 ms
Housing material	Nickel-plated brass, PBT, display: TPU, ultrasonic transducer: polyurethane foam, glass epoxy resin
Connection type	Connector M12, 5-pin
Indication	LED display, 2 x LED
Weight	
30 mm ... 250 mm, 350 mm	150 g
65 mm ... 350 mm, 600 mm	150 g
200 mm ... 1,300 mm, 2,000 mm	150 g
350 mm ... 3,400 mm, 5,000 mm	210 g
600 mm ... 6,000 mm, 8,000 mm	270 g

¹⁾ Limit values, reverse-polarity protected, operation in short-circuit protected network: max. 8 A.

²⁾ 15 V ... 30 V when using analog voltage output.

³⁾ Without load.

Ambient data

Enclosure rating	IP 67
Protection class	III
Ambient temperature	Operation: -25 °C ... +70 °C Storage: -40 °C ... +85 °C

Ordering information

- **Sub product family:** UM30-2
- **Sending axis:** straight

Working range, limiting range	Response time	Output rate	Switching output ¹⁾	Analog output	Model name	Part no.
30 mm ... 250 mm, 350 mm	50 ms	8 ms	1 x PNP (200 mA) ²⁾	-	UM30-211111	6037660
				1 x 0 V ... 10 V (≥ 100 kΩ) ³⁾ 1 x 4 mA ... 20 mA (≤ 500 Ω) ^{3) 4) 5)}	UM30-211118	6036921
			2 x PNP (200 mA) ²⁾	-	UM30-211112	6037664
				-	UM30-211115	6037669
			1 x NPN (200 mA) ⁶⁾ 2 x NPN (200 mA) ⁶⁾	-	UM30-211114	6037674
				-	UM30-211113	6036916

¹⁾ Output Q short-circuit protected.

²⁾ PNP: HIGH = $V_s - (< 2 V)$ / LOW = 0 V.

³⁾ Automatic selection of analog current or voltage output dependent on load.

⁴⁾ For 4 mA ... 20 mA and $V_s \leq 20 V$ max. load ≤ 100 Ω.

⁵⁾ Subsequent smoothing of the analog output, depending on the application, may increase the response time by up to 200 %.

⁶⁾ NPN: HIGH ≤ 2 V / LOW = V_s .

Working range, limiting range	Response time	Output rate	Switching output ¹⁾	Analog output	Model name	Part no.
65 mm ... 350 mm, 600 mm	70 ms	16 ms	1 x PNP (200 mA) ²⁾	-	UM30-212111	6037661
				1 x 0 V ... 10 V ($\geq 100 \text{ k}\Omega$) ³⁾ 1 x 4 mA ... 20 mA ($\leq 500 \Omega$) ^{3) 4) 5)}	UM30-212118	6036922
			2 x PNP (200 mA) ²⁾	-	UM30-212112	6037665
			1 x NPN (200 mA) ⁶⁾	-	UM30-212115	6037670
			2 x NPN (200 mA) ⁶⁾	-	UM30-212114	6037675
			-	1 x 0 V ... 10 V ($\geq 100 \text{ k}\Omega$) ³⁾ 1 x 4 mA ... 20 mA ($\leq 500 \Omega$) ^{3) 4) 5)}	UM30-212113	6036917
200 mm ... 1,300 mm, 2,000 mm	110 ms	23 ms	1 x PNP (200 mA) ²⁾	-	UM30-213111	6037537
				1 x 0 V ... 10 V ($\geq 100 \text{ k}\Omega$) ³⁾ 1 x 4 mA ... 20 mA ($\leq 500 \Omega$) ^{3) 4) 5)}	UM30-213118	6036923
			2 x PNP (200 mA) ²⁾	-	UM30-213112	6037666
			1 x NPN (200 mA) ⁶⁾	-	UM30-213115	6037671
			2 x NPN (200 mA) ⁶⁾	-	UM30-213114	6037676
			-	1 x 0 V ... 10 V ($\geq 100 \text{ k}\Omega$) ³⁾ 1 x 4 mA ... 20 mA ($\leq 500 \Omega$) ^{3) 4) 5)}	UM30-213113	6036918
350 mm ... 3,400 mm, 5,000 mm	180 ms	43 ms	1 x PNP (200 mA) ²⁾	-	UM30-214111	6037662
				1 x 0 V ... 10 V ($\geq 100 \text{ k}\Omega$) ³⁾ 1 x 4 mA ... 20 mA ($\leq 500 \Omega$) ^{3) 4) 5)}	UM30-214118	6036924
			2 x PNP (200 mA) ²⁾	-	UM30-214112	6037667
			1 x NPN (200 mA) ⁶⁾	-	UM30-214115	6037672
			2 x NPN (200 mA) ⁶⁾	-	UM30-214114	6037677
			-	1 x 0 V ... 10 V ($\geq 100 \text{ k}\Omega$) ³⁾ 1 x 4 mA ... 20 mA ($\leq 500 \Omega$) ^{3) 4) 5)}	UM30-214113	6036919

¹⁾ Output Q short-circuit protected.

²⁾ PNP: HIGH = V_S - (< 2 V) / LOW = 0 V.

³⁾ Automatic selection of analog current or voltage output dependent on load.

⁴⁾ For 4 mA ... 20 mA and $V_S \leq 20 \text{ V}$ max. load $\leq 100 \Omega$.

⁵⁾ Subsequent smoothing of the analog output, depending on the application, may increase the response time by up to 200 %.

⁶⁾ NPN: HIGH $\leq 2 \text{ V}$ / LOW = V_S .

Working range, limiting range	Response time	Output rate	Switching output ¹⁾	Analog output	Model name	Part no.
600 mm ... 6,000 mm, 8,000 mm	240 ms	60 ms	1 x PNP (200 mA) ²⁾	-	UM30-215111	6037663
				1 x 0 V ... 10 V ($\geq 100 \text{ k}\Omega$) ³⁾ 1 x 4 mA ... 20 mA ($\leq 500 \Omega$) ^{3) 4) 5)}	UM30-215118	6036925
			2 x PNP (200 mA) ²⁾	-	UM30-215112	6037668
			1 x NPN (200 mA) ⁶⁾	-	UM30-215115	6037673
			2 x NPN (200 mA) ⁶⁾	-	UM30-215114	6037678
			-	1 x 0 V ... 10 V ($\geq 100 \text{ k}\Omega$) ³⁾ 1 x 4 mA ... 20 mA ($\leq 500 \Omega$) ^{3) 4) 5)}	UM30-215113	6036920

¹⁾ Output Q short-circuit protected.

²⁾ PNP: HIGH = $V_s - (< 2 \text{ V})$ / LOW = 0 V.

³⁾ Automatic selection of analog current or voltage output dependent on load.

⁴⁾ For 4 mA ... 20 mA and $V_s \leq 20 \text{ V}$ max. load $\leq 100 \Omega$.

⁵⁾ Subsequent smoothing of the analog output, depending on the application, may increase the response time by up to 200 %.

⁶⁾ NPN: HIGH $\leq 2 \text{ V}$ / LOW = V_s .

Dimensional drawings (Dimensions in mm (inch))

UM30-211, UM30-212, UM30-213

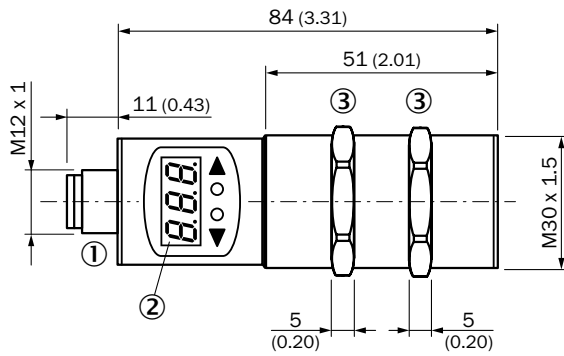

- ① Connection
- ② Display
- ③ Mounting nuts, SW 36 mm

UM30-214

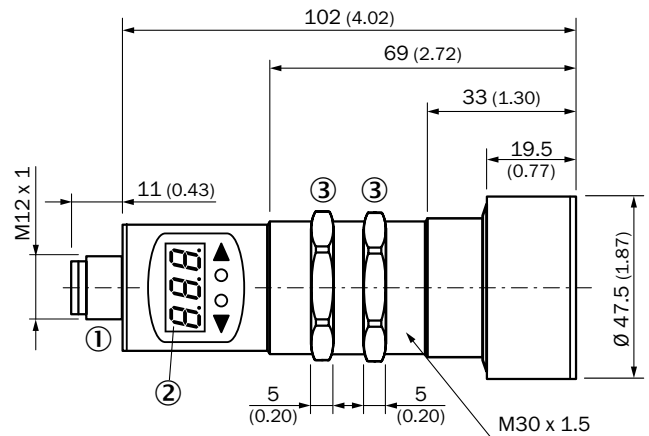

- ① Connection
- ② Display
- ③ Mounting nuts, SW 36 mm

UM30-215

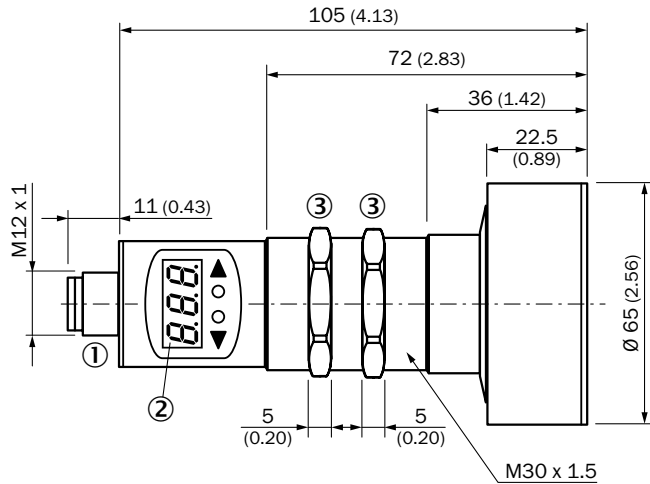

- ① Connection
- ② Display
- ③ Mounting nuts, SW 36 mm

Adjustments

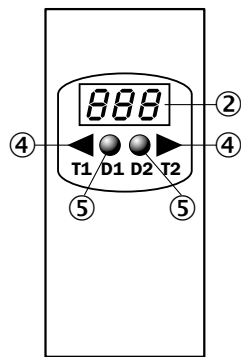

- ② Display
- ④ Control elements
- ⑤ Status indicators

Connection type and diagram

UM30-21x111
UM30-21x115
Connector M12, 5-pin

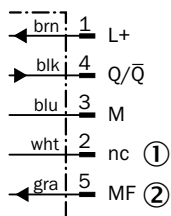

- ① Not connected
- ② Multifunctional input/synchronization and multiplex operation/multiplex operation/communication Connect+

UM30-21x112
UM30-21x114
Connector M12, 5-pin

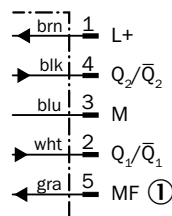

- ① Multifunctional input/synchronization and multiplex operation/communication Connect+

UM30-21x113
Connector M12, 5-pin



- ① Not connected
- ② Multifunctional input/synchronization and multiplex operation/communication Connect+

UM30-21x118
Connector M12, 5-pin



- ① Multifunctional input/synchronization and multiplex operation/communication Connect+

Detection areas

UM30-211

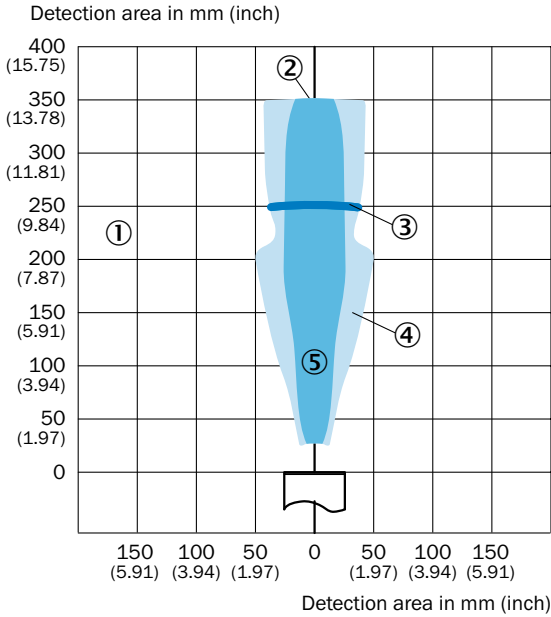

- ① Detection area dependent on reflection properties, size and orientation of the object
- ② Operating range
- ③ Limiting range
- ④ Example object: Aligned plate 500 mm x 500 mm
- ⑤ Example object: Pipe with 10 mm diameter

UM30-212

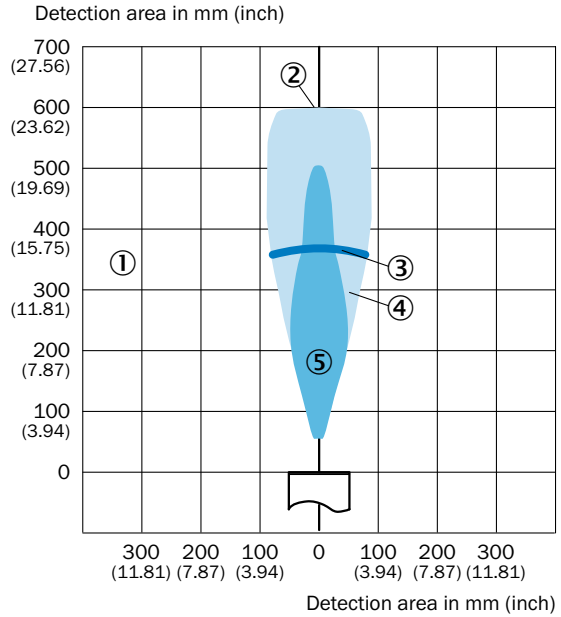

- ① Detection area dependent on reflection properties, size and orientation of the object
- ② Operating range
- ③ Limiting range
- ④ Example object: Aligned plate 500 mm x 500 mm
- ⑤ Example object: Pipe with 27 mm diameter

UM30-213

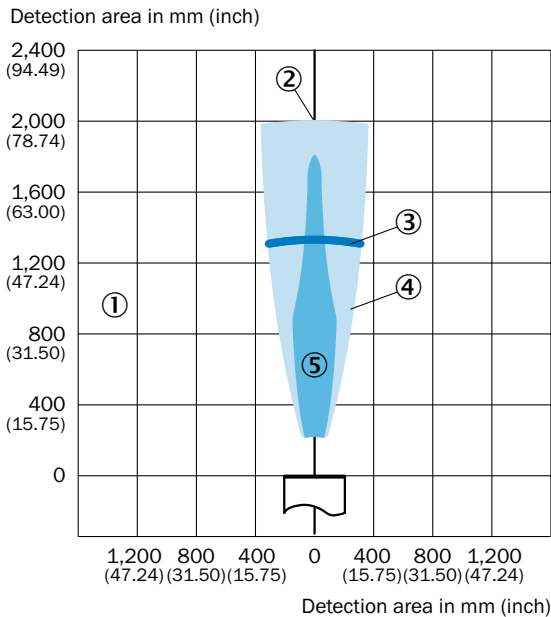

- ① Detection area dependent on reflection properties, size and orientation of the object
- ② Operating range
- ③ Limiting range
- ④ Example object: Aligned plate 500 mm x 500 mm
- ⑤ Example object: Pipe with 27 mm diameter

UM30-214

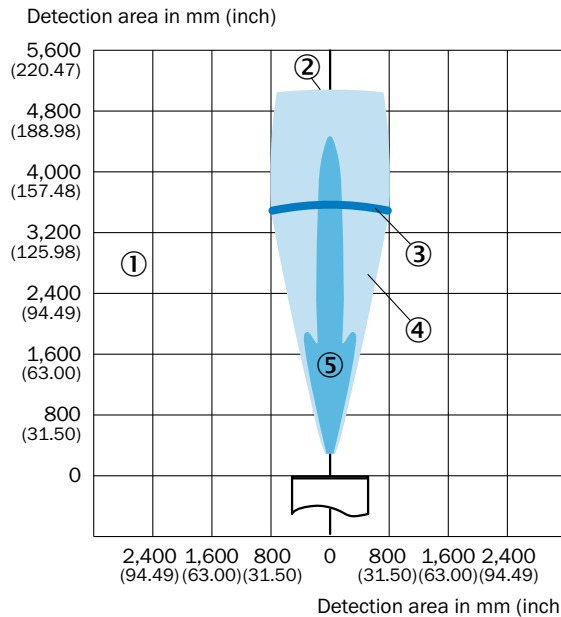

- ① Detection area dependent on reflection properties, size and orientation of the object
- ② Operating range
- ③ Limiting range
- ④ Example object: Aligned plate 500 mm x 500 mm
- ⑤ Example object: Pipe with 27 mm diameter

UM30-215

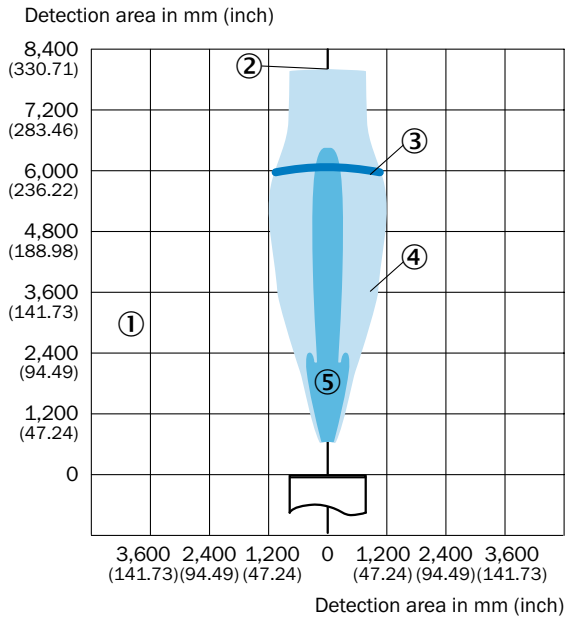



- ① Detection area dependent on reflection properties, size and orientation of the object
- ② Operating range
- ③ Limiting range
- ④ Example object: Aligned plate 500 mm x 500 mm
- ⑤ Example object: Pipe with 27 mm diameter

Recommended accessories



Mounting brackets/plates

Mounting brackets

	Description	Model name	Part no.
	Mounting plate for M30 sensors	BEF-WG-M30	5321871
	Mounting bracket, M30 thread	BEF-WN-M30	5308445

Plug connectors and cables

Connecting cable (female connector-open)

	Connection type head A	Connection type head B	Cable	Model name	Part no.
 Illustration may differ	Female connector, M12, 5-pin, straight	Cable	PVC, unshielded, 2 m	DOL-1205-G02M	6008899
 Illustration may differ	Female connector, M12, 5-pin, angled	Cable	PVC, unshielded, 2 m	DOL-1205-W02M	6008900

Programming and configuration tools

	Description	Model name	Part no.
	Tool for visualization, configuration and cloning, 3-digit LED display, supply voltage DV 9 V ... 30 V	Connect+ adapter (CPA)	6037782

Terminal and alignment brackets

Terminal brackets

	Description	Model name	Part no.
	Mounting bracket, M30, axial rotation possible, with threaded mounting hole M6	BEF-HA-M30A	5311527

→ For additional accessories, please see www.mysick.com/en/UM30

SIMPLE SET UP, PERFECT DETECTION

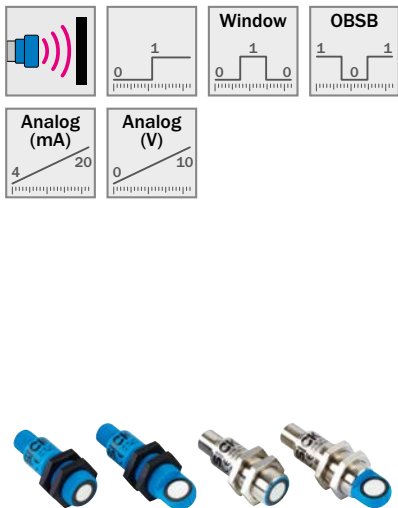

Analog (mA)
4 20

Analog (V)
0 10

Window

OBSB



CE **III** **RoHS 2002/95/EC**

IO-Link

Additional information

Detailed technical data 23

Ordering information 25

Dimensional drawings 27

Connection type and diagram 27

Detection areas 28

Recommended accessories 29

Product description

The UM18 ultrasonic sensor family provides simplicity and high functionality. The UM18 ultrasonic sensors are available in straight and right-angle versions for easy machine integration. A metal or plastic housing allows use in demanding environmental conditions. Due to four sensing ranges up to

1,300 mm and LED status feedback, the sensors are suitable for a broad range of applications. In addition to variants with an analog current or voltage output, versions with a PNP/NPN switching output or a push-pull switching output with IO-Link are available.

At a glance

- Reliable measurement independent of material color, transparency, gloss and ambient light
- Four ranges up to 1,300 mm
- Short metal or plastic M18 housing with a length of 41 mm
- Straight or right-angle version
- High immunity to dirt, dust, humidity and fog
- PNP/NPN switching output, analog output or push-pull switching output with IO-Link
- Synchronization and multiplex modes are available

Your benefits

- Four sensing ranges up to 1,300 mm provide a range of flexible mounting options
- Easy machine integration due to short M18 housing available in straight or right-angle versions
- Intelligent measurement filters and versions with temperature compensation guarantee reliable measurement results for maximum process reliability
- Solid, one-piece metal housing secures highest machine availability
- Synchronization or multiplex mode enables simultaneous operation of up to 10 sensors, improving application flexibility and process reliability
- Easy system integration due to a wide range of available output signals
- Unintentional adjustments to sensor settings are eliminated since teach-in process is done with an external wire
- Variety of application solutions due to insensitivity and reliability of ultrasound technology

→ www.mysick.com/en/UM18

For more information, just enter the link or scan the QR code and get direct access to technical data, CAD design models, operating instructions, software, application examples and much more.



Detailed technical data

Performance

	UM18-2 Core	UM18-2 Pro
Working range, limiting range	20 mm ... 150 mm, 250 mm 30 mm ... 250 mm, 350 mm 65 mm ... 350 mm, 600 mm 120 mm ... 1,000 mm, 1,300 mm	
Resolution	0.2 mm	≥ 0.069 mm
Repeatability ¹⁾	± 0.15 %	
Accuracy ¹⁾	0.17 % / K	± 1 % ²⁾
Temperature compensation	-	✓
Switching frequency		
20 mm ... 150 mm, 250 mm	25 Hz	
30 mm ... 250 mm, 350 mm	25 Hz	
65 mm ... 350 mm, 600 mm	12 Hz	
120 mm ... 1,000 mm, 1,300 mm	10 Hz	
Ultrasonic frequency (typical)		
20 mm ... 150 mm, 250 mm	380 kHz	
30 mm ... 250 mm, 350 mm	320 kHz	
65 mm ... 350 mm, 600 mm	400 kHz	
120 mm ... 1,000 mm, 1,300 mm	200 kHz	
Detection area (typical)	See diagrams	
Additional function ³⁾	Set switching mode: Distance to object (DtO) / Window (Wnd) / Object between sensor and background (ObSB) Teach-in of switching output Inverted switching output Reset to factory default	Set switching mode: Distance to object (DtO) / Window (Wnd) / Object between sensor and background (ObSB) Teach-in of switching output Inverted switching output Temperature compensation IO-Link Multifunctional input: external teach / synchronization / multiplexing Synchronization of up to 10 sensors Multiplexing: no cross talk of up to 10 sensors Teach-in of analog output Invertible analog output Reset to factory default

¹⁾ Referring to current measurement value.

²⁾ Temperature compensation can be switched off, without temperature compensation: 0.17 % / K.

³⁾ Functions may vary depending on sensor type.

Interfaces

	UM18-2 Core	UM18-2 Pro
Resolution analog output	-	12 bit
Multifunctional input (MF)	-	1 x MF
Hysteresis		
20 mm ... 150 mm, 250 mm	2 mm	
30 mm ... 250 mm, 350 mm	3 mm	
65 mm ... 350 mm, 600 mm	5 mm	
120 mm ... 1,000 mm, 1,300 mm	20 mm	

Mechanics/electronics

	UM18-2 Core	UM18-2 Pro
Supply voltage V_s ¹⁾	DC 10 V ... 30 V	DC 10 V ... 30 V ²⁾
Power consumption ³⁾	≤ 1.2 W	
Initialization time	< 300 ms	
Housing material	PBT, ultrasonic transducer: polyurethane foam, glass epoxy resin	Nickel-plated brass, ultrasonic transducer: polyurethane foam, glass epoxy resin
Connection type	Connector M12, 4-pin	Connector M12, 5-pin
Indication	2 x LED	
Weight	15 g 20 g	25 g 30 g

¹⁾ Limit values, reverse-polarity protected, operation in short-circuit protected network: max. 8 A.

²⁾ 15 V ... 30 V when using analog voltage output.

³⁾ Without load.

Ambient data

	UM18-2 Core	UM18-2 Pro
Enclosure rating	IP 67	
Protection class	III	
Ambient temperature	Operation: -25 °C ... +70 °C Storage: -40 °C ... +85 °C	

Ordering information

Sub product family	Working range, limiting range	Response time	Output rate	Sending axis	Switching output	Analog output	Model name	Part no.
UM18-2 Core	20 mm ... 150 mm, 250 mm	32 ms	8 ms	Straight	1 x PNP (200 mA) ¹⁾	-	UM18-217161101	6048408
					1 x NPN (200 mA) ²⁾	-	UM18-217165101	6048410
				Angled	1 x PNP (200 mA) ¹⁾	-	UM18-217161102	6048409
					1 x NPN (200 mA) ²⁾	-	UM18-217165102	6048411
	30 mm ... 250 mm, 350 mm	32 ms	8 ms	Straight	1 x PNP (200 mA) ¹⁾	-	UM18-211161101	6048412
					1 x NPN (200 mA) ²⁾	-	UM18-211165101	6048414
				Angled	1 x PNP (200 mA) ¹⁾	-	UM18-211161102	6048413
					1 x NPN (200 mA) ²⁾	-	UM18-211165102	6048415
	65 mm ... 350 mm, 600 mm	64 ms	16 ms	Straight	1 x PNP (200 mA) ¹⁾	-	UM18-212161101	6048416
					1 x NPN (200 mA) ²⁾	-	UM18-212165101	6048418
				Angled	1 x PNP (200 mA) ¹⁾	-	UM18-212161102	6048417
					1 x NPN (200 mA) ²⁾	-	UM18-212165102	6048419
120 mm ... 1,000 mm, 1,300 mm	80 ms	20 ms	Straight	1 x PNP (200 mA) ¹⁾	-	UM18-218161101	6048420	
				1 x NPN (200 mA) ²⁾	-	UM18-218165101	6048422	
			Angled	1 x PNP (200 mA) ¹⁾	-	UM18-218161102	6048421	
				1 x NPN (200 mA) ²⁾	-	UM18-218165102	6048423	
UM18-2 Pro	20 mm ... 150 mm, 250 mm	32 ms	8 ms	Straight	1 x push-pull: PNP/NPN (100 mA); IO-Link ^{3) 4)}	-	UM18-21712A211	6048384
					-	1 x 4 mA ... 20 mA ($\leq 500 \Omega$) ^{5) 6)}	UM18-217126111	6048386
					-	1 x 0 V ... 10 V ($\geq 100 \text{ k}\Omega$) ⁶⁾	UM18-217127111	6048388
				Angled	1 x push-pull: PNP/NPN (100 mA); IO-Link ^{3) 4)}	-	UM18-21712A212	6048385
					-	1 x 4 mA ... 20 mA ($\leq 500 \Omega$) ^{5) 6)}	UM18-217126112	6048387
					-	1 x 0 V ... 10 V ($\geq 100 \text{ k}\Omega$) ⁶⁾	UM18-217127112	6048389

¹⁾ PNP: HIGH = $V_S - (< 2 \text{ V})$ / LOW = 0 V.

²⁾ NPN: HIGH $\leq 2 \text{ V}$ / LOW = V_S .

³⁾ Output Q short-circuit protected.

⁴⁾ Push-Pull: PNP/NPN HIGH = $U_V - (< 4 \text{ V})$ / LOW $< 2 \text{ V}$.

⁵⁾ For 4 mA ... 20 mA and $V_S \leq 20 \text{ V}$ max. load $\leq 100 \Omega$.

⁶⁾ Subsequent smoothing of the analog output, depending on the application, may increase the response time by up to 200 %.

Sub product family	Working range, limiting range	Response time	Output rate	Sending axis	Switching output	Analog output	Model name	Part no.
UM18-2 Pro	30 mm ... 250 mm, 350 mm	32 ms	8 ms	Straight	1 x push-pull: PNP/NPN (100 mA); IO-Link ^{3) 4)}	-	UM18-21112A211	6048390
					-	1 x 4 mA ... 20 mA ($\leq 500 \Omega$) ^{5) 6)}	UM18-211126111	6048392
					-	1 x 0 V ... 10 V ($\geq 100 \text{ k}\Omega$) ⁶⁾	UM18-211127111	6048394
				Angled	1 x push-pull: PNP/NPN (100 mA); IO-Link ^{3) 4)}	-	UM18-21112A212	6048391
					-	1 x 4 mA ... 20 mA ($\leq 500 \Omega$) ^{5) 6)}	UM18-211126112	6048393
					-	1 x 0 V ... 10 V ($\geq 100 \text{ k}\Omega$) ⁶⁾	UM18-211127112	6048395
	65 mm ... 350 mm, 600 mm	64 ms	16 ms	Straight	1 x push-pull: PNP/NPN (100 mA); IO-Link ^{3) 4)}	-	UM18-21212A211	6048396
					-	1 x 4 mA ... 20 mA ($\leq 500 \Omega$) ^{5) 6)}	UM18-212126111	6048398
					-	1 x 0 V ... 10 V ($\geq 100 \text{ k}\Omega$) ⁶⁾	UM18-212127111	6048400
				Angled	1 x push-pull: PNP/NPN (100 mA); IO-Link ^{3) 4)}	-	UM18-21212A212	6048397
					-	1 x 4 mA ... 20 mA ($\leq 500 \Omega$) ^{5) 6)}	UM18-212126112	6048399
					-	1 x 0 V ... 10 V ($\geq 100 \text{ k}\Omega$) ⁶⁾	UM18-212127112	6048401
	120 mm ... 1,000 mm, 1,300 mm	80 ms	20 ms	Straight	1 x push-pull: PNP/NPN (100 mA); IO-Link ^{3) 4)}	-	UM18-21812A211	6048402
					-	1 x 4 mA ... 20 mA ($\leq 500 \Omega$) ^{5) 6)}	UM18-218126111	6048404
					-	1 x 0 V ... 10 V ($\geq 100 \text{ k}\Omega$) ⁶⁾	UM18-218127111	6048406
				Angled	1 x push-pull: PNP/NPN (100 mA); IO-Link ^{3) 4)}	-	UM18-21812A212	6048403
					-	1 x 4 mA ... 20 mA ($\leq 500 \Omega$) ^{5) 6)}	UM18-218126112	6048405
					-	1 x 0 V ... 10 V ($\geq 100 \text{ k}\Omega$) ⁶⁾	UM18-218127112	6048407

¹⁾ PNP: HIGH = V_s - (< 2 V) / LOW = 0 V.

²⁾ NPN: HIGH $\leq 2 \text{ V}$ / LOW = V_s .

³⁾ Output Q short-circuit protected.

⁴⁾ Push-Pull: PNP/NPN HIGH = U_v - (< 4 V) / LOW < 2 V.

⁵⁾ For 4 mA ... 20 mA and $V_s \leq 20 \text{ V}$ max. load $\leq 100 \Omega$.

⁶⁾ Subsequent smoothing of the analog output, depending on the application, may increase the response time by up to 200 %.

Dimensional drawings (Dimensions in mm (inch))

UM18-2xxxxxx1

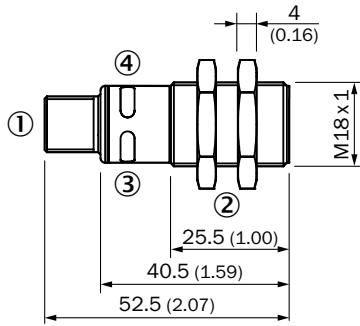

- ① Connection
- ② Mounting nuts, SW 24 mm
- ③ Status indicator power on (green)
- ④ Status indicator switching/analog output (orange)

UM18-2xxxxxx2

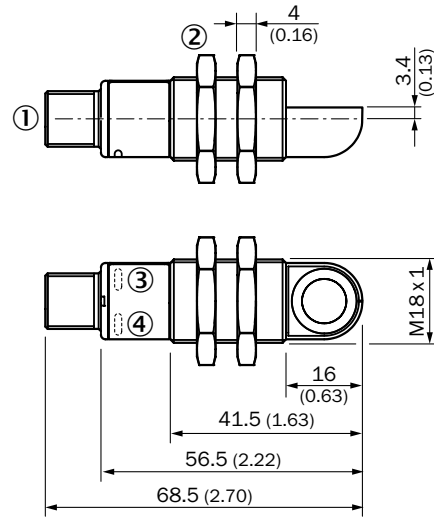

- ① Connection
- ② Mounting nuts, SW 24 mm
- ③ Status indicator power on (green)
- ④ Status indicator switching/analog output (orange)

Connection type and diagram

UM18-21xxx1xxx

UM18-21xxx5xxx

Connector M12, 5-pin

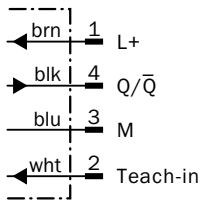

UM18-21xxxAxxx

Connector M12, 5-pin

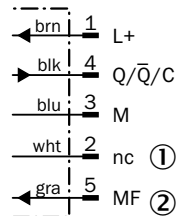

- ① Not connected
- ② Multifunctional input/synchronization and multiplex operation/communication Connect+

UM18-21xxx6xxx

UM18-21xxx7xxx

Connector M12, 5-pin

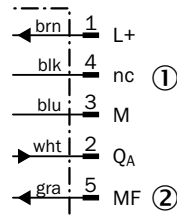

- ① Not connected
- ② Multifunctional input/synchronization and multiplex operation/communication Connect+

Detection areas

UM18-217

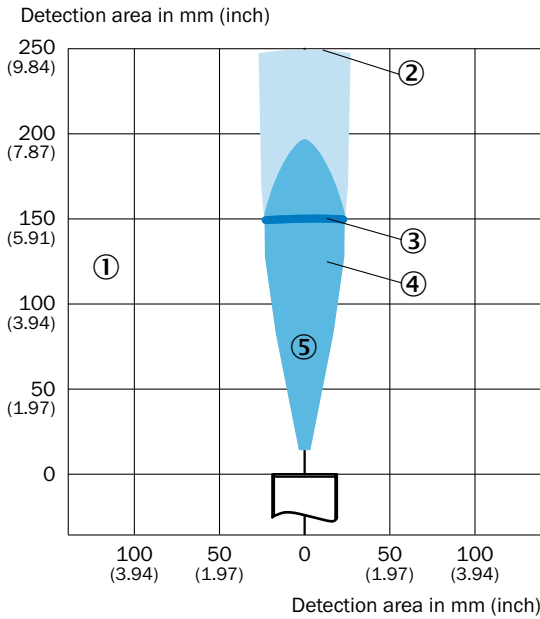

- ① Detection area dependent on reflection properties, size and orientation of the object
- ② Operating range
- ③ Limiting range
- ④ Example object: Aligned plate 500 mm x 500 mm
- ⑤ Example object: Pipe with 10 mm diameter

UM18-211

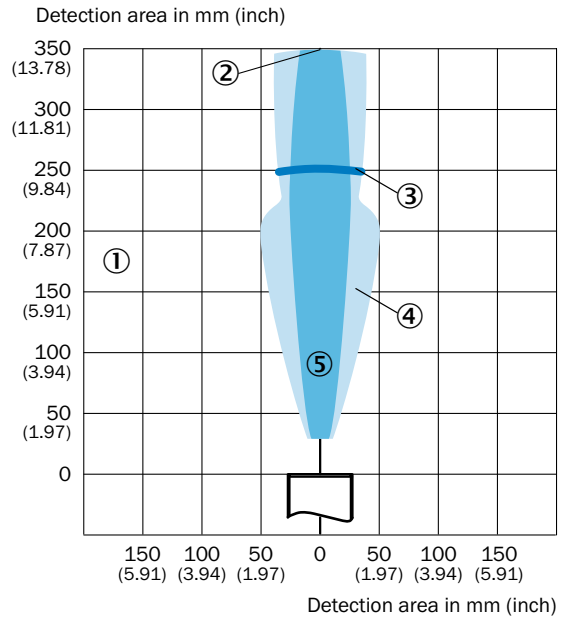

- ① Detection area dependent on reflection properties, size and orientation of the object
- ② Operating range
- ③ Limiting range
- ④ Example object: Aligned plate 500 mm x 500 mm
- ⑤ Example object: Pipe with 10 mm diameter

UM18-212

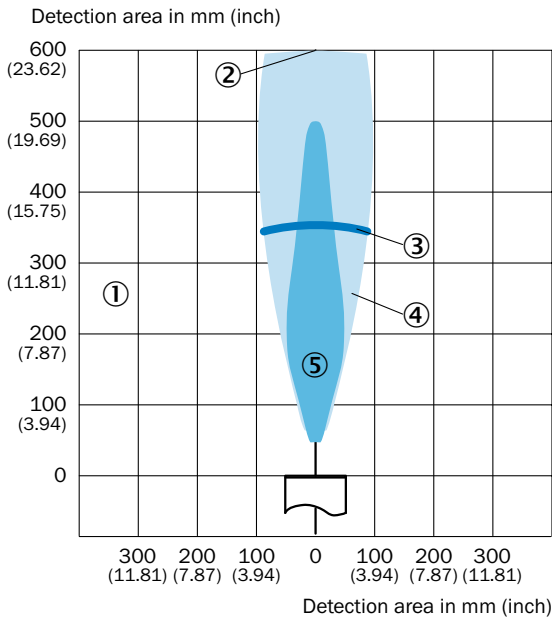

- ① Detection area dependent on reflection properties, size and orientation of the object
- ② Operating range
- ③ Limiting range
- ④ Example object: Aligned plate 500 mm x 500 mm
- ⑤ Example object: Pipe with 27 mm diameter

UM18-218

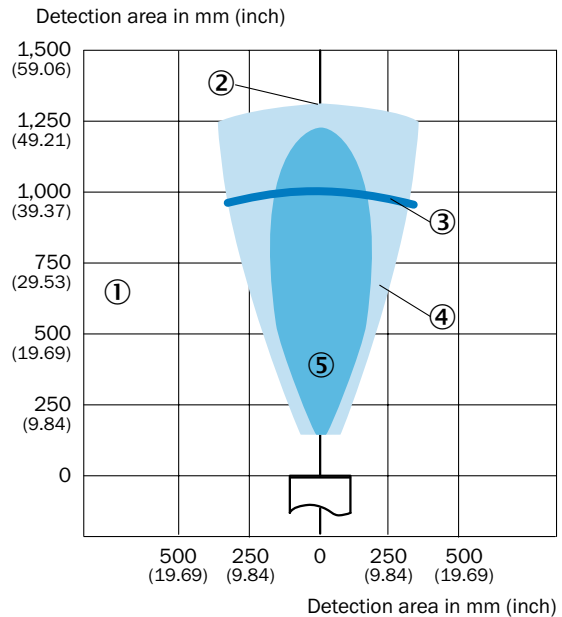



- ① Detection area dependent on reflection properties, size and orientation of the object
- ② Operating range
- ③ Limiting range
- ④ Example object: Aligned plate 500 mm x 500 mm
- ⑤ Example object: Pipe with 27 mm diameter

Recommended accessories





Mounting brackets/plates

Mounting brackets

	Description	Model name	Part no.	UM18-2 Core	UM18-2 Pro
	Mounting plate for M18 sensors	BEF-WG-M18	5321870	●	●
	Mounting bracket, M18 thread	BEF-WN-M18	5308446	●	●

Plug connectors and cables

Connecting cable (female connector-open)

	Connection type head A	Connection type head B	Cable	Model name	Part no.	UM18-2 Core	UM18-2 Pro
 Illustration may differ	Female connector, M12, 4-pin, straight	Cable	PVC, unshielded, 2 m	DOL-1204-G02M	6009382	●	-
 Illustration may differ	Female connector, M12, 4-pin, angled	Cable	PVC, unshielded, 2 m	DOL-1204-W02M	6009383	●	-
 Illustration may differ	Female connector, M12, 5-pin, straight	Cable	PVC, unshielded, 2 m	DOL-1205-G02M	6008899	-	●
 Illustration may differ	Female connector, M12, 5-pin, angled	Cable	PVC, unshielded, 2 m	DOL-1205-W02M	6008900	-	●

Programming and configuration tools

	Description	Model name	Part no.	UM18-2 Core	UM18-2 Pro
	Tool for visualization, configuration and cloning, 3-digit LED display, supply voltage DV 9 V ... 30 V	Connect+ adapter (CPA)	6037782	-	●

Terminal and alignment brackets

Alignment brackets

	Description	Model name	Part no.	UM18-2 Core	UM18-2 Pro
	Mounting bracket with ball-and-socket	BEF-WN-M18-ST02	5312973	●	●

Terminal brackets

	Description	Model name	Part no.	UM18-2 Core	UM18-2 Pro
	Clamping block for round sensors M18, with fixed stop	BEF-KHF-M18	2051482	●	●

Universal bar clamp systems

	Description	Model name	Part no.	UM18-2 Core	UM18-2 Pro
	Plate H for universal clamp bracket	BEF-KHS-H01	2022465	●	●

→ For additional accessories, please see www.mysick.com/en/UM18

ULTRASONIC TECHNOLOGY HOUSED IN AN INDUSTRY-PROVEN DESIGN



The image shows a blue SICK UC12 ultrasonic sensor. Above the sensor are four technical diagrams: a sensor icon, a pulse diagram, a 'Window' mode diagram, and an 'OBSB' mode diagram. Below the sensor are the CE mark, a diamond-shaped III mark, and the RoHS 2002/95/EC logo.

Additional information

- Detailed technical data 33
- Ordering information 34
- Dimensional drawing 34
- Adjustments 34
- Connection type and diagram 35
- Detection areas 35
- Recommended accessories 36

Product description

Ultrasonic technology provides reliable results where optical sensors reach their limits. The UC12 shares the same housing as common photoelectric sen-

sors. In addition a single teach-in button enables easy setup. Dark or transparent objects are easily detected.

At a glance

- Object detection independent of material color and ambient light – even transparent foils, glass, liquids and bottles are reliably detected
- Fast and easy teach-in with single push-button
- Immune to dirt, dust and fog
- Two ambivalent switching outputs (Q, \bar{Q})
- Excellent background suppression
- Three operation modes: Distance to Object (DtO), Window (Wnd) or Object between sensor and background (ObSB)

Your benefits

- Fast commissioning due to single-button teach-in
- Full mechanical compatibility to photoelectric sensors increase application flexibility without machine modification
- Standard proximity, window and reflection modes provide application flexibility, which increases reliability and productivity
- Integrated temperature compensation ensures high measurement accuracy
- Complementary switching outputs immediately signal broken wiring, reducing faulty production results

→ www.mysick.com/en/UC12

For more information, just enter the link or scan the QR code and get direct access to technical data, CAD design models, operating instructions, software, application examples and much more.



Detailed technical data

Performance

Working range, limiting range	20 mm ... 150 mm, 250 mm 55 mm ... 250 mm, 350 mm
Resolution	≥ 0.1 mm
Repeatability ¹⁾	± 0.15 %
Accuracy ¹⁾	± 1 %
Temperature compensation	✓
Switching frequency	25 Hz
Ultrasonic frequency (typical)	
20 mm ... 150 mm, 250 mm	380 kHz
55 mm ... 250 mm, 350 mm	500 kHz
Detection area (typical)	See diagrams
Additional function	Set switching mode: Distance to object (DtO) / Window (Wnd) / Object between sensor and background (ObSB) Teach-in of switching output Temperature compensation Lock user interface Reset to factory default

¹⁾ Referring to current measurement value.

Interfaces

Hysteresis	2 mm
-------------------	------

Mechanics/electronics

Supply voltage V_s ¹⁾	DC 10 V ... 30 V
Power consumption ²⁾	≤ 1.2 W
Initialization time	< 300 ms
Housing material	Die-cast zinc, ultrasonic transducer: polyurethane foam, glass epoxy resin
Connection type	Connector M12, 4-pin
Indication	Dual LED
Weight	75 g

¹⁾ Limit values, reverse-polarity protected, operation in short-circuit protected network: max. 8 A.

²⁾ Without load.

Ambient data

Enclosure rating	IP 67
Protection class	III
Ambient temperature	Operation: -25 °C ... +70 °C Storage: -40 °C ... +85 °C

Ordering information

- **Response time:** 30 ms
- **Output rate:** 8 ms
- **Sending axis:** straight

Working range, limiting range	Switching output ^{1) 2)}	Model name	Part no.
20 mm ... 150 mm, 250 mm	2 x PNP (500 mA) ³⁾	UC12-11231	6029831
	2 x NPN (500 mA) ⁴⁾	UC12-11235	6029833
55 mm ... 250 mm, 350 mm	2 x PNP (500 mA) ³⁾	UC12-12231	6029832
	2 x NPN (500 mA) ⁴⁾	UC12-12235	6029834

¹⁾ Output Q short-circuit protected.

²⁾ Complementary switching outputs (Q, \bar{Q})

³⁾ PNP: HIGH = $V_s - (< 2 V)$ / LOW = 0 V.

⁴⁾ NPN: HIGH $\leq 2 V$ / LOW = V_s .

Dimensional drawing (Dimensions in mm (inch))

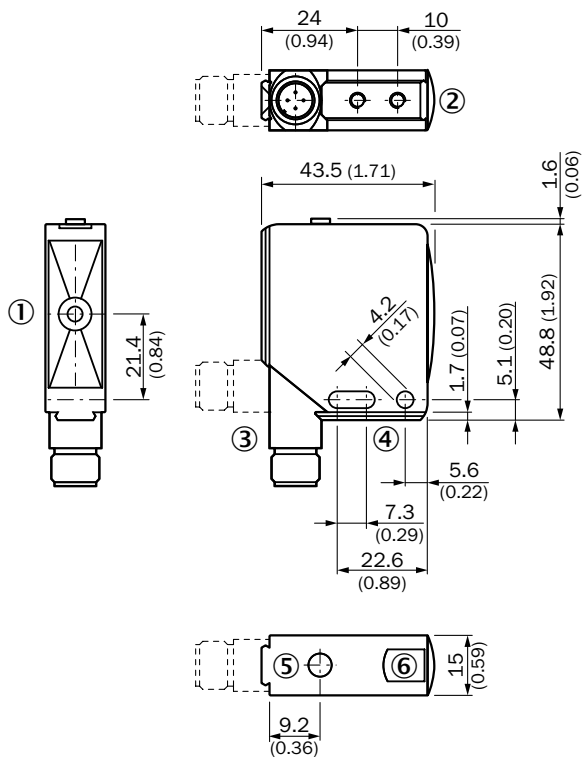

- ① Transmission and reception axis
- ② M4 threaded mounting hole, 4 mm deep
- ③ Connection
- ④ Mounting hole
- ⑤ Control elements
- ⑥ Status indicator switching output (orange) and power on (green)

Adjustments

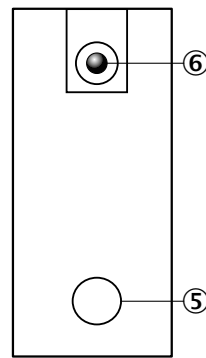

- ⑤ Control elements
- ⑥ Status indicator switching output (orange) and power on (green)

Connection type and diagram

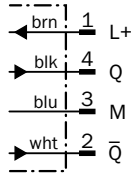
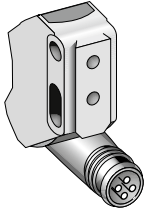

Detection areas

UC12-11

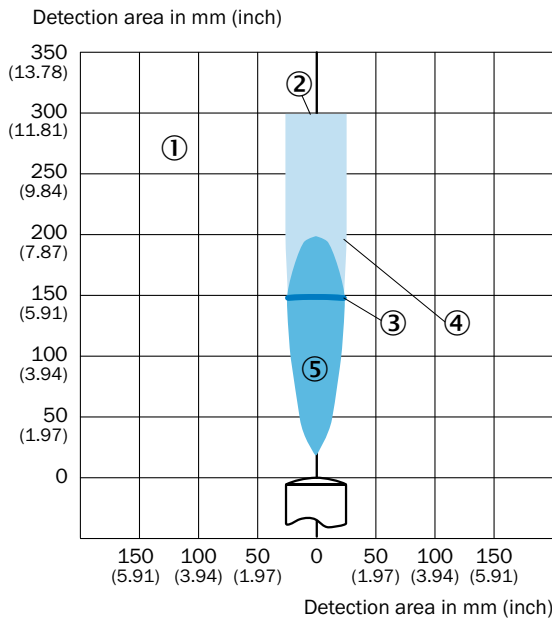

- ① Detection area dependent on reflection properties, size and orientation of the object
- ② Operating range
- ③ Limiting range
- ④ Example object: Aligned plate 10 mm x 10 mm
- ⑤ Example object: Pipe with 10 mm diameter

UC12-12

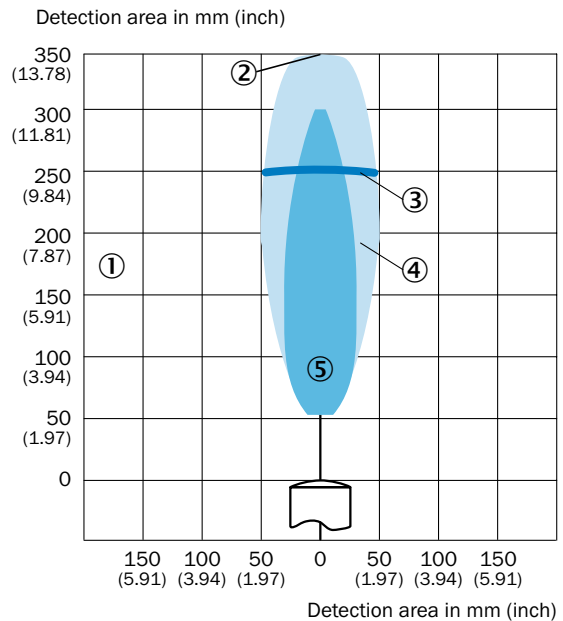

- ① Detection area dependent on reflection properties, size and orientation of the object
- ② Operating range
- ③ Limiting range
- ④ Example object: Aligned plate 10 mm x 10 mm
- ⑤ Example object: Pipe with 10 mm diameter

Recommended accessories



Mounting brackets/plates

Mounting brackets

	Beschreibung	Typ	ArtikelNr.
	Mounting bracket, large	BEF-WG-W12	2013942
	Mounting bracket, small	BEF-WK-W12	2012938

Plug connectors and cables

Connecting cable (female connector-open)

	Anschlussart Kopf A	Anschlussart Kopf B	Leitung	Typ	ArtikelNr.
 Illustration may differ	Female connector, M12, 4-pin, straight	Cable	PVC, unshielded, 2 m	DOL-1204-G02M	6009382
 Illustration may differ	Female connector, M12, 4-pin, angled	Cable	PVC, unshielded, 2 m	DOL-1204-W02M	6009383

Universal bar clamp systems

	Beschreibung	Typ	ArtikelNr.
	Plate D for universal bar clamp	BEF-KHS-D01	2022461
	Plate L or universal bar clamp	BEF-KHS-L01	2023057
	Plate N02 or universal bar clamp	BEF-KHS-N02	2051608

→ For additional accessories, please see www.mysick.com/en/UC12

SMALL, PRECISE, ULTRASONIC











Additional information

Detailed technical data 39

Ordering information 40

Dimensional drawing 40

Adjustments 40

Connection type and diagram41

Detection areas41

Recommended accessories42

Product description

The UC4 ultrasonic sensor family combines state-of-the-art ultrasonic technology in a miniature housing. This compact, lightweight sensor not only detects transparent objects, but it also

provides excellent background suppression, making it ideal for use in challenging conditions. The UC4 product line is the perfect solution for tough applications in confined spaces.

At a glance

- Integrated time-of-flight technology detects objects such as glass, liquids and transparent foils, independent of color
- Three operation modes: Distance to Object (DtO), Window (Wnd) or Object between sensor and background (ObSB)
- Immunity to dirt, dust and fog
- One PNP/NPN switching output
- Excellent background suppression

Your benefits

- Mini housing allows for quick and easy integration, even in the most confined spaces
- Immunity to dirt and dust ensures reliable object detection, even in challenging environmental conditions
- Integrated temperature compensation ensures high measurement accuracy
- Various switching outputs provide application flexibility, which increases reliability and productivity
- Full mechanical compatibility to photoelectric sensors increase application flexibility without machine modification
- Economical version available for simple, cost-sensitive applications
- Fast machine setup due to easy-to-use teach-in button

→ www.mysick.com/en/UC4

For more information, just enter the link or scan the QR code and get direct access to technical data, CAD design models, operating instructions, software, application examples and much more.



Detailed technical data

Performance

Working range, limiting range ¹⁾	13 mm ... 100 mm, 150 mm 13 mm ... 150 mm, 250 mm
Resolution	≥ 0.1 mm
Repeatability ²⁾	± 0.15 %
Accuracy ²⁾	
13 mm ... 100 mm, 150 mm	0.17 % / K
13 mm ... 150 mm, 250 mm	± 1 %
Temperature compensation ²⁾	
13 mm ... 100 mm, 150 mm	-
13 mm ... 150 mm, 250 mm	✓
Switching frequency	20 Hz
Ultrasonic frequency (typical)	380 kHz
Detection area (typical)	See diagrams
Additional function ³⁾	Set switching mode: Distance to object (DtO) / Window (Wnd) / Object between sensor and background (ObSB) Teach-in of switching output Switching output invertible Temperature compensation Lock user interface Reset to factory default

¹⁾ Teach-in from 21 mm.

²⁾ Referring to current measurement value.

³⁾ Functions may vary depending on sensor type.

Interfaces

Hysteresis	2 mm
-------------------	------

Mechanics/electronics

Supply voltage V_s ¹⁾	DC 20 V ... 30 V
Power consumption ²⁾	≤ 0.75 W
Initialization time	< 300 ms
Housing material	ABS-plastic, ultrasonic transducer: polyurethane foam, glass epoxy resin
Connection type	Connector M8, 3-pin
Indication	2 x LED
Weight	10 g

¹⁾ Limit values, reverse-polarity protected, operation in short-circuit protected network: max. 8 A.

²⁾ Without load.

Ambient data

Enclosure rating	IP 67
Protection class	III
Ambient temperature	Operation: -25 °C ... +70 °C Storage: -40 °C ... +85 °C

Ordering information

- **Response time:** 30 ms
- **Output rate:** 8 ms
- **Sending axis:** straight

Working range, limiting range ¹⁾	Switching output ²⁾	Model name	Part no.
13 mm ... 100 mm, 150 mm	1 x PNP (200 mA) ³⁾	UC4-11341	6034667
	1 x NPN (200 mA) ⁴⁾	UC4-11345	6034668
13 mm ... 150 mm, 250 mm	1 x PNP (200 mA) ³⁾	UC4-13341	6034669
	1 x NPN (200 mA) ⁴⁾	UC4-13345	6034670

¹⁾ Teach-in from 21 mm.

²⁾ Output Q short-circuit protected.

³⁾ PNP: HIGH = V_s - (< 2 V) / LOW = 0 V.

⁴⁾ NPN: HIGH ≤ 2 V / LOW = V_s.

Dimensional drawing (Dimensions in mm (inch))

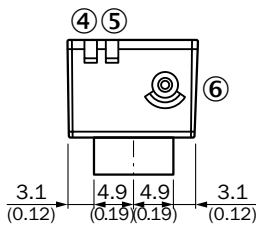
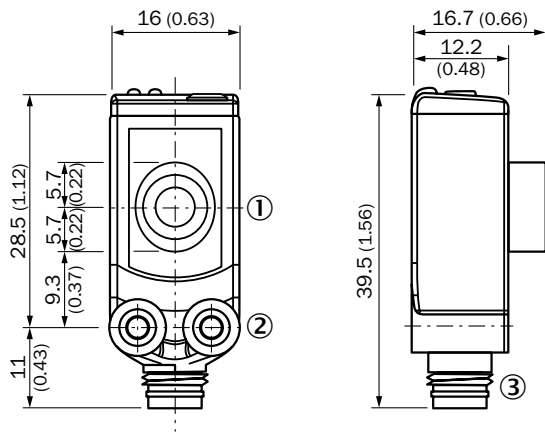

Adjustments

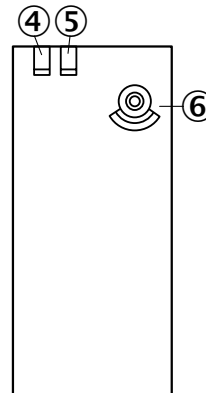

④ Status indicator switching output (orange)

⑤ Status indicator power on (green)

⑥ Control elements

- ① Transmission and reception axis
- ② Threaded mounting hole M3
- ③ Connection
- ④ Status indicator switching output (orange)
- ⑤ Status indicator power on (green)
- ⑥ Control elements

Connection type and diagram

Connector M8, 3-pin

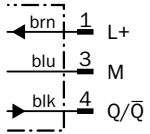
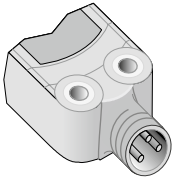

Detection areas

UC4-11

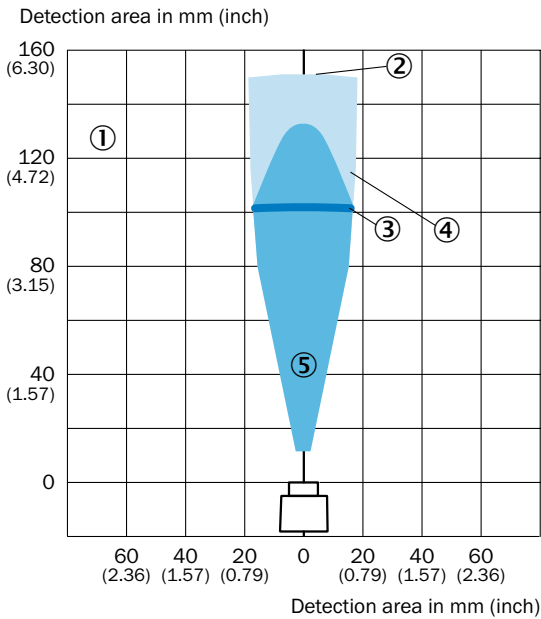

- ① Detection area dependent on reflection properties, size and orientation of the object
- ② Operating range
- ③ Limiting range
- ④ Example object: Aligned plate 100 mm x 100 mm
- ⑤ Example object: Pipe with 10 mm diameter

UC4-13

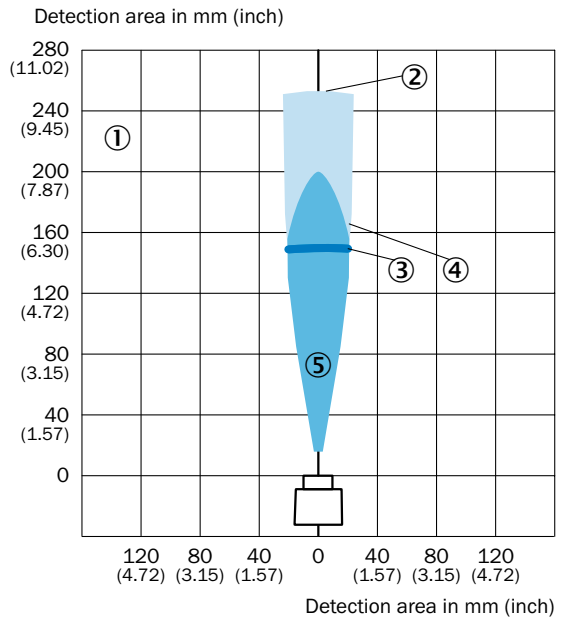

- ① Detection area dependent on reflection properties, size and orientation of the object
- ② Operating range
- ③ Limiting range
- ④ Example object: Aligned plate 100 mm x 100 mm
- ⑤ Example object: Pipe with 10 mm diameter

Recommended accessories

Mounting brackets/plates

Mounting brackets

	Beschreibung	Typ	ArtikelNr.
	Mounting bracket for wall mounting	BEF-W4-A	2051628



Terminal and alignment brackets

Alignment brackets

	Beschreibung	Typ	ArtikelNr.
	Ball joint bracket	BEF-GH-MINI02	2027128

Plug connectors and cables

Connecting cable (female connector-open)

	Anschlussart Kopf A	Anschlussart Kopf B	Leitung	Typ	ArtikelNr.
 Illustration may differ	Female connector, M8, 3-pin, straight	Cable	PVC, unshielded, 2 m	DOL-0803-G02M	6010785
 Illustration may differ	Female connector, M8, 3-pin, angled	Cable	PVC, unshielded, 2 m	DOL-0803-W02M	6008489

Universal bar clamp systems

	Beschreibung	Typ	ArtikelNr.
	Plate H for universal bar clamp	BEF-KHS-H01	2022465

→ For additional accessories, please see www.mysick.com/en/UC4

WWW.MYSICK.COM – SEARCH ONLINE AND ORDER

Search online quickly and safely - with the SICK "Finders"

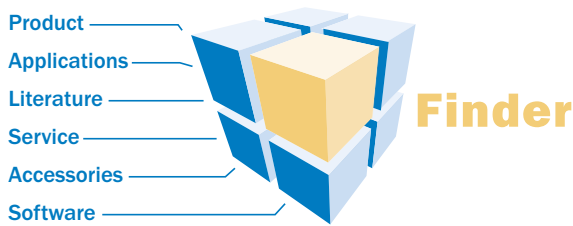

Product Finder: We can help you to quickly target the product that best matches your application.

Applications Finder: Select the application description on the basis of the challenge posed, industrial sector, or product group.

Literature Finder: Go directly to the operating instructions, technical information, and other literature on all aspects of SICK products.

Efficiency – with the E-Commerce-Tools from SICK

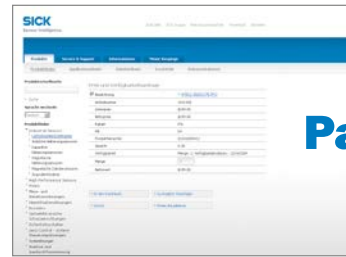

Partner Portal
www.mysick.com

Find out prices and availability

Determine the price and possible delivery date of your desired product simply and quickly at any time.

Request or view a quote

You can have a quote generated online here. Every quote is confirmed to you via e-mail.

Order online

You can go through the ordering process in just a few steps.

FOR SAFETY AND PRODUCTIVITY: SICK LIFETIME SERVICES

SICK LifeTime Services is a comprehensive set of high-quality services provided to support the entire life cycle of products and applications from system design all the way to upgrades. These services increase the safety of people, boost the productivity of machines and serve as the basis for our customers' sustainable business success.



Consulting & Design

Globally available experts for cost-effective solutions



Product & System Support

Fast and reliable, by telephone or on location



Verification & Optimization

Checks and recommendations for increased availability



Upgrade & Retrofits

Uncovers new potential for machines and systems



Training & Education

Employee qualification for increased competitiveness

SICK AT A GLANCE

SICK is a leading manufacturer of intelligent sensors and sensor solutions for factory, logistics, and process automation. With more than 6,000 employees and over 40 subsidiaries worldwide, we are always close our customers. A unique range of products and services creates the perfect basis for controlling processes securely and efficiently, protecting individuals from accidents and preventing damage to the environment.

We have extensive experience in various industries and understand their processes and requirements. With intelligent sensors, we can deliver exactly what our customers need. In application centers in Europe, Asia and North America, system solutions are tested and optimized in accordance with customer specifications. All this makes us a reliable supplier and development partner.

Comprehensive services round out our offering: SICK LifeTime Services provide support throughout the machine life cycle and ensure safety and productivity.

For us, that is “Sensor Intelligence.”

Worldwide presence:

Australia, Belgium/Luxembourg, Brasil, Česká Republika, Canada, China, Danmark, Deutschland, España, France, Great Britain, India, Israel, Italia, Japan, México, Nederland, Norge, Österreich, Polska, România, Russia, Schweiz, Singapore, Slovenija, South Africa, South Korea, Suomi, Sverige, Taiwan, Türkiye, United Arab Emirates, USA.

Please find detailed addresses and additional representatives and agencies in all major industrial nations at: www.sick.com