

# BALLUFF

sensors worldwide

## BUS Ultrasonic Sensors

Precise – simple and reliable



TouchControl

650

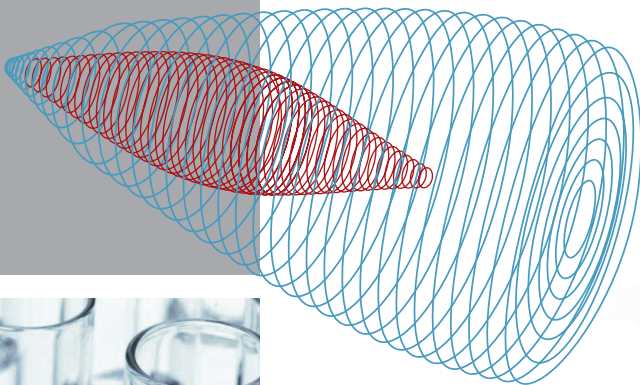
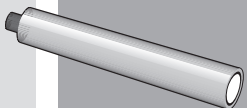



With over 50 years of sensor experience, Balluff is a leading global sensor specialist with its own line of connectivity products for every area of factory automation. Balluff is based in Germany and has a tight international network of 54 representatives and subsidiaries.

**Use maximum precision with Balluff ultrasonic sensors.**

Balluff stands for comprehensive systems from a single source, continuous innovation, state-of-the-art technology, highest quality, and greatest reliability. That's not all: Balluff also stands for exceptional customer orientation, customized solutions, fast worldwide service, and outstanding application assistance.

High-quality, innovative products – certified in accordance with DIN ISO 9001:2008 (EN 29001) – are a secure foundation for optimized value creation for our customers.



Whether electronic and mechanical sensors, rotary and linear transducers, identification systems or optimized connection technology for high-performance automation, Balluff masters not only the entire technological variety with all of the different operating principles, but also provides technology that fulfills regional quality standards and is suitable for use worldwide. Wherever you are in the world, Balluff technology is never far away. You won't have to look far for you nearest Balluff expert.



Balluff products increase performance, quality and productivity around the world every day. They satisfy prerequisites for meeting demands for greater performance and cost reductions on the global market. Even in the most demanding areas. No matter how stringent your requirements may be, Balluff delivers state-of-the-art solutions.

# Ultrasonic Sensors

## Precise – simple and reliable

Table of contents	3
Media	4
Industries, application areas	5
Application areas, sensor selection	6
Modes	7
M30 tubular-style housing	8
M18 tubular-style housing	10
R06 block-style housing	12
M12 tubular-style housing	14
Q80 block-style housing	15

### Regardless of color and material

BUS ultrasonic sensors are perfect for distance measurement or position detection of granules, fluids and powders. They measure fill levels, heights and sag without making contact as well as count and monitor the presence of objects.

They are extremely versatile, operate independently of color and surface finish, and are not affected by transparent objects that generate strong reflections.

Ultrasonic sensors are precision all-rounders designed for critical situations. Dust, dirt and steam do not pose a problem.

### Broad detection range – high precision

Their detection range extends from 20 mm to 8 m, meaning that even longer object distances can be handled without problem. Their high resolution and small blind zones ensure extreme precision.

Integral synchronization means that the sensors do not interfere with one another.

### Switching and analog variants

Our BUS ultrasonic sensors differ from one another in their output signal. Each series is available as a switching or analog version, whereby all analog versions are available with voltage or current output (0...10 V or 4...20 mA). The BUS M30 includes variants with two switching outputs, one switching and one analog output or two switching outputs and one analog output so that one sensor can adopt the function of a second sensor.

### IO-Link

BUS 18M sensors with push/pull output are equipped with an IO-Link interface that enables a change from SIO mode to IO-Link mode.



### The all-rounders, even for difficult environments

Because the distance to the object is determined via a sound transit time, ultrasonic sensors have excellent background suppression. With their transit time measurement, ultrasonic sensors can record the measured

value with highly-precise resolution. Some sensors to even 0.025 mm. The sensors are able to measure in dusty air or through paint spray mist. Nearly all materials that reflect the sound are detected. Even

thin foils, crystal clear materials and different colors are no problem for ultrasonic sensors. Thin deposits on the sensor membrane do not affect sensor function.



#### Colors

Red, green, yellow or blue — all make no difference to Balluff ultrasonic sensors: they reliably detect all colors.



#### Transparent layers

Glass plates, Plexiglas and razor thin foils — BUS ultrasonic sensors reliably detect transparent layers.



#### Surfaces of bulk materials

Fine sand, shavings or coarse-grained materials — in the areas of fill-level measurement, our ultrasonic sensors are unbeatable.



#### Contrasts

Black objects against a black background or white on white — even with weak contrasts, our BUS sensors measure without ifs and buts.



#### Liquids

Clear water, cloudy liquids, oils or black coffee — ultrasonic sensors can be used with nearly any liquid. The liquid surface should have no foam.

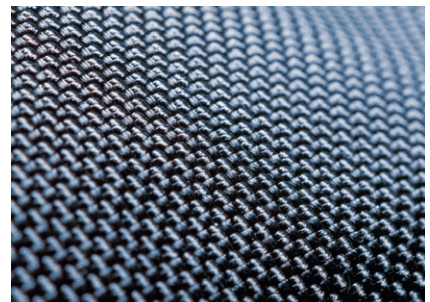

#### Material surfaces

Whether velvet, wool or leather — nearly all clothing materials can be simply detected with our BUS ultrasonic sensors.

BUS ultrasonic sensors are particularly well suited for the following industries

- Handling and automation
- Specialty machine construction
- Automotive industry
- Bottling and packaging
- Pharmaceutical industry
- Plastic and rubber industry
- Timber and furniture industry
- Paper and printing industry
- Conveying
- Commercial vehicles
- Scales
- Agricultural machinery
- Food processing machinery
- Office and information technology
- Construction and building material machinery
- Textile machinery



**Handling and automation**



**Bottling and packaging**



**Automotive industry**

Ultrasonic sensors can be used in many application areas

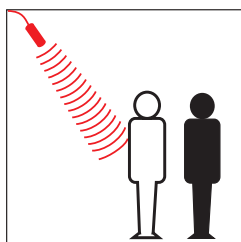

**Detection of people**

If people need to be detected, a sensor should be used that has an operating scanning range that is considerably greater than the required measurement distance. The greater the operating scanning range, the lower the ultrasonic frequency. And the better absorbent pieces of clothing, such as wool, can be detected.

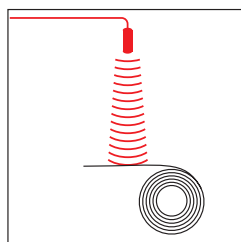

**Foil tear monitoring**

Ultrasonic sensors with switching output can be used for foil tear monitoring. If large waves are formed in the foil, the sensor should be operated as a diffuse reflective sensor. This operating mode functions reliably even if the sound is reflected by waves in the foil.

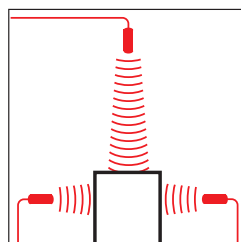

**Height and width measurement**

Through the use of multiple BUS M30 or BUS\_18M ultrasonic sensors, three-dimensional measurements can be made for everything from small boxes to large cartons.

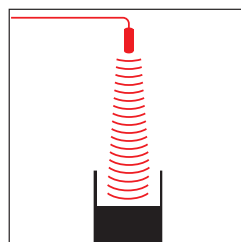

**Presence verification**

BUS detect filled or empty pallets and measure the content of transport containers. If a box or a container is to be inspected with multiple sensors, they can be synchronized with each other.

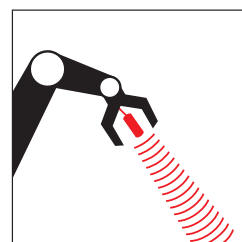

**Robot positioning**

Due to their small dimensions, BUS are ideally suited for exactly positioning robot arms: BUS\_18M ultrasonic sensors in threaded sleeve and BUS R06K in block-style housing.

Other applications on the next page

# Ultrasonic Sensors

## Application areas, sensor selection

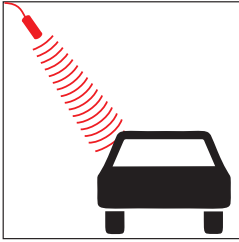

### Positioning

When scanning glass plates or other smooth and flat surfaces, make certain that the ultrasound strikes the surface at a right angle.

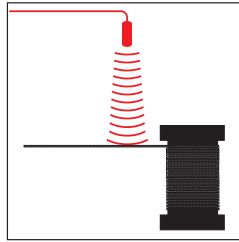

### Wire-breakage monitoring

When winding and unwinding a wire rope, ultrasonic sensors with analog output detect its position on the layer.

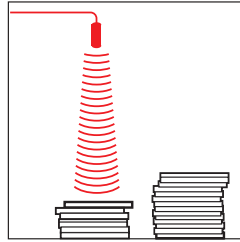

### Stack-height detection

Whether wooden boards, glass plates, paper or color plastic plates, BUS ultrasonic sensors measure stack heights with high precision.

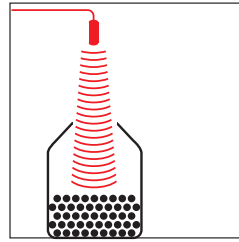

### Fill-level monitoring

In silos, bunkers, containers – for all bulk materials (e.g., sand, gravel, coal, grain), our ultrasonic sensors are ideal.

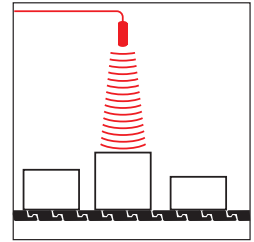

### Object detection

BUS ultrasonic sensors sort containers and parts with different heights. BUS count objects. And with absolute reliability.

## Sensor selection

Important selection criteria for an ultrasonic sensor are its scanning range and the associated, three-dimensional detection range.

### Definitions

#### Blind zone

The blind zone defines the smallest reliable scanning range of the sensor. There must be no objects or interfering reflections within the blind zone, as measurement errors may otherwise occur.

#### Operating scanning range

The operating scanning range is the typical working range of a sensor. For objects with good reflective properties, it can also be used up to its limiting scanning range.

#### Detection range

The detection range is measured using various standard reflectors.

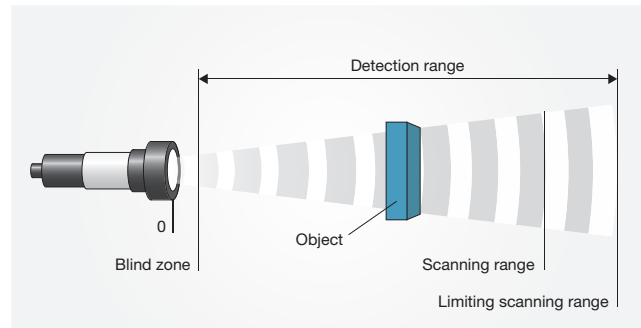

### Detection ranges

The red areas are measured with a thin round rod ( $\varnothing$  10 mm or 27 mm, depending on sensor type) and show the typical working range of a sensor.

To obtain the blue areas, a plate is moved into the sound fields from the side. In doing so, the optimum angle of the plate to the sensor is set. This is thus the maximum detection range of the sensor.

It is not possible to evaluate ultrasound reflections outside of the blue sound cones.

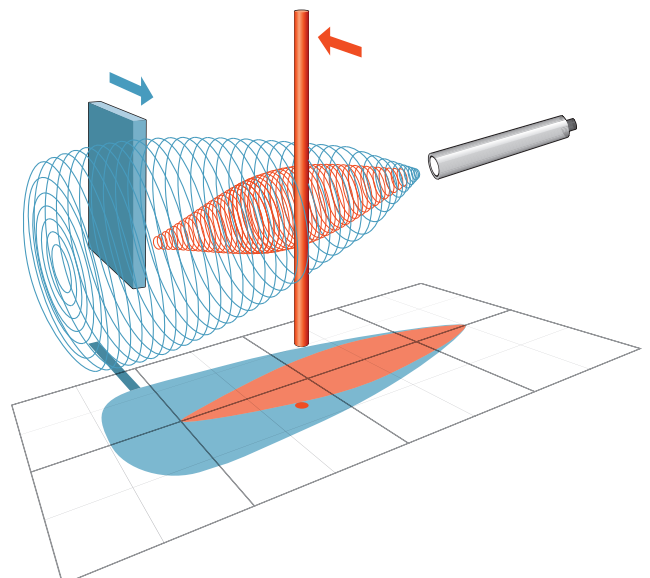

# Ultrasonic Sensors

## Modes

The **ultrasonic sensor as a diffuse reflective sensor** is the classic operating mode. Compared to other sensor principles, it has superior background suppression. During operation, the switching output is set as soon as the object is located within the set switching distance. The switch point has a hysteresis. The operating mode is suitable for, e.g., counting objects on a conveyor belt or for performing presence verification.

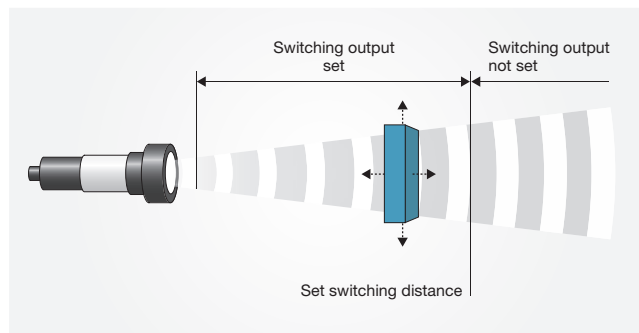

The **ultrasonic sensor in window mode** is an extended function of the ultrasonic diffuse reflective sensor. In this case, the switching output can only be set if the object is located within a window that is defined by two window limits. This can be used to monitor, e.g., the correct bottle size in a bottle crate. Bottles that are too tall or too short are sorted out. Window mode and the diffuse reflection ultrasonic sensor can be set on all ultrasonic sensors that are equipped with teach-in.

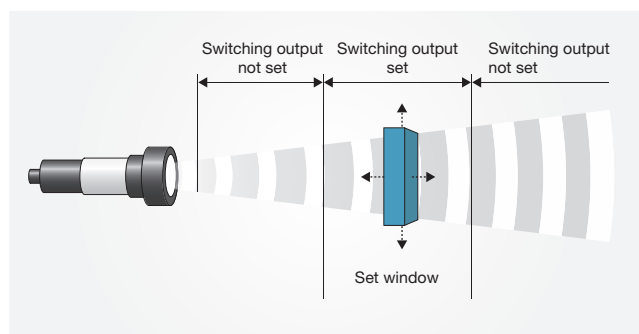

The function of the **diffuse reflection ultrasonic sensor** is similar to that of a photoelectric sensor. Any reflector, such as a metal sheet, is sufficient. In window mode, the ultrasonic sensor is set so that the permanently mounted reflector lies within the window. The ultrasonic sensor returns a signal as soon as an object fully covers the reflector. It plays no role here whether the object completely absorbs or reflects away the sound. This operating mode is therefore used for materials that can be only poorly reflected, such as foam, or for scanning objects with irregular surfaces.

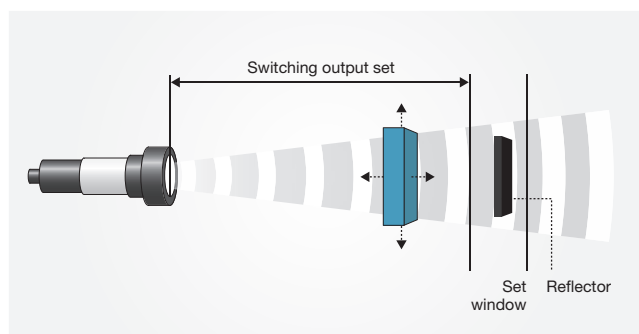

**Ultrasonic sensors with analog output** output the measured distance value as a voltage that is proportional to distance (0...10 V) or as current that is proportional distance (4...20 mA). For the ultrasonic sensors with analog output, the sensor-near and sensor-distant window limits of the analog characteristic as well as a rising or falling characteristic can be set. Depending on the sensor model and window width, the resolution is between 0.025 mm and 0.36 mm.

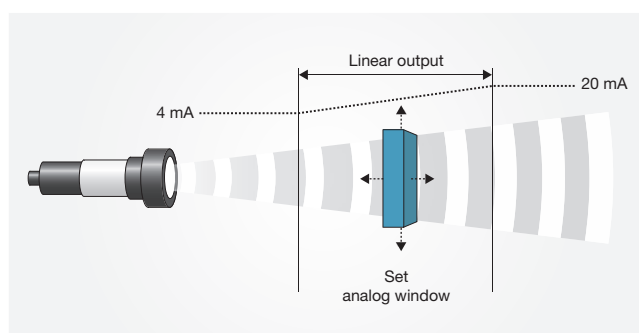

**Ultrasonic sensors with IO-Link** enable gapless communication through all levels of the system architecture: from the sensor to the top fieldbus level. Transmission of the measured distance value to the controller is bit serial.

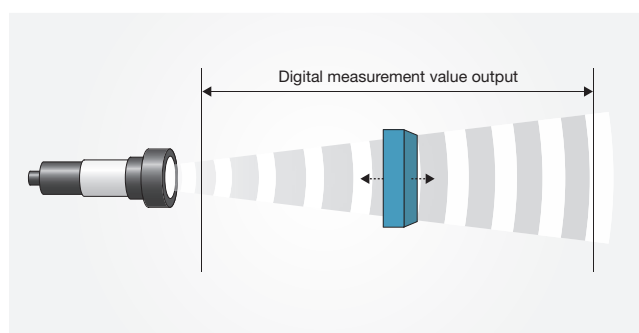

# Ultrasonic Sensors

## M30 tubular-style housing



- **Display with direct, measured value output**  
for immediately visible results
- **Numeric setting of the sensor via the display**  
for completely presetting the sensor
- **Automatic synchronization and multiplex operation**  
for simultaneous operation of up to ten sensors
- **5 scanning ranges with a measuring range from 30 mm to 8 m**
- **1 or 2 switching outputs in PNP- or NPN-design**
- **Analog output 4...20 mA and 0...10 V**  
Automatic changeover between current and voltage output
- **Analog output plus switching output**  
for measurement that is proportional to distance with an additional limit value
- **Teach-in via 2 buttons**  
for simple, menu-driven commissioning

### Scanning range

Blind zone

Limiting scanning range

### BUS M30M switching output

Resolution

PNP,

NO/NC contact

**Ordering code**

Part number

NPN,

NO/NC contact

**Ordering code**

Part number

2x PNP,

NO/NC contact

**Ordering code**

Part number

2x NPN,

NO/NC contact

**Ordering code**

Part number

### BUS M30M analog output

Resolution (depends on analog window used)

0...10 V / 4...20 mA

**Ordering code**

Part number

### BUS M30M switching and analog output

Resolution (depends on analog window used)

0...10 V / 4...20 mA

PNP, NO/NC contact

**Ordering code**

Part number

0...10 V / 4...20 mA

2x NPN, NO/NC contact

**Ordering code**

Part number

Sensors are also available in stainless steel variants.



### TouchControl

With TouchControl, all settings are made on the sensors. The three-digit LED indicator continuously displays the current distance value and automatically switches between mm and cm display. Two buttons are used to call up the configuration and navigate through the self-explanatory menu structure.



### Inspecting transport boxes for completeness

Performance shows up on conveyor belts. Multiple ultrasonic sensors simultaneously monitor transport containers for completeness. Reflective, transparent or different-colored surfaces are reliably detected. In multiplex operation, mutual interference of the sensors is prevented.



# Ultrasonic Sensors

## M30 tubular-style housing

### General data

Supply voltage	9...30 V DC, polarity reversal protected	
Output current	200 mA	
Accuracy	± 1% (temperature drift internally compensated)	
Degree of protection as per EN 60529	IP 67	
Operating temperature	-25...+70°C	
Material	Housing	Nickel-plated brass, plastic parts: PBT, TPU
	Sensing surface	Polyurethane foam, epoxy resin containing glass
Connection	M12 connector, 5-pin	

	30...250 mm	65...350 mm	200...1300 mm	350...3400 mm	600...6000 mm
	30 mm	65 mm	200 mm	350 mm	600 mm
	350 mm	600 mm	2000 mm	5000 mm	8000 mm

	0.025 mm	0.025 mm	0.18 mm	0.18 mm	0.18 mm
	<b>BUS0022</b>	<b>BUS005F</b>	<b>BUS0039</b>	<b>BUS003P</b>	<b>BUS0045</b>
	BUS M30M1-PPX-03/025-S92K	BUS M30M1-PPX-07/035-S92K	BUS M30M1-PPX-20/130-S92K	BUS M30M1-PPX-35/340-S92K	BUS M30M1-PPX-60/600-S92K
	<b>BUS002J</b>	<b>BUS005P</b>	<b>BUS0036</b>	<b>BUS003J</b>	<b>BUS0054</b>
	BUS M30M1-NPX-03/025-S92K	BUS M30M1-NPX-07/035-S92K	BUS M30M1-NPX-20/130-S92K	BUS M30M1-NPX-35/340-S92K	BUS M30M1-NPX-60/600-S92K
	<b>BUS002R</b>	<b>BUS005H</b>	<b>BUS003C</b>	<b>BUS003W</b>	<b>BUS003Z</b>
	BUS M30M1-PWX-03/025-S92K	BUS M30M1-PWX-07/035-S92K	BUS M30M1-PWX-20/130-S92K	BUS M30M1-PWX-35/340-S92K	BUS M30M1-PWX-60/600-S92K
	<b>BUS002H</b>	<b>BUS005R</b>	<b>BUS0035</b>	<b>BUS0046</b>	<b>BUS0055</b>
	BUS M30M1-NWX-03/025-S92K	BUS M30M1-NWX-07/035-S92K	BUS M30M1-NWX-20/130-S92K	BUS M30M1-NWX-35/340-S92K	BUS M30M1-NWX-60/600-S92K

	0.025...0.10 mm	0.025...0.17 mm	0.18...0.57 mm	0.18...1.5 mm	0.18...2.4 mm
	<b>BUS002N</b>	<b>BUS005K</b>	<b>BUS003F</b>	<b>BUS003T</b>	<b>BUS0041</b>
	BUS M30M1-XC-03/025-S92K	BUS M30M1-XC-07/035-S92K	BUS M30M1-XC-20/130-S92K	BUS M30M1-XC-35/340-S92K	BUS M30M1-XC-60/600-S92K

	0.025...0.10 mm	0.025...0.17 mm	0.18...0.57 mm	0.18...1.5 mm	0.18...2.4 mm
	<b>BUS002L</b>	<b>BUS005M</b>	<b>BUS0038</b>	<b>BUS003L</b>	<b>BUS0043</b>
	BUS M30M1-PPC-03/025-S92K	BUS M30M1-PPC-07/035-S92K	BUS M30M1-PPC-20/130-S92K	BUS M30M1-PPC-35/340-S92K	BUS M30M1-PPC-60/600-S92K
			<b>BUS003N</b>	<b>BUS0044</b>	
			BUS M30M1-PWC-20/130-S92K	BUS M30M1-PWC-35/340-S92K	

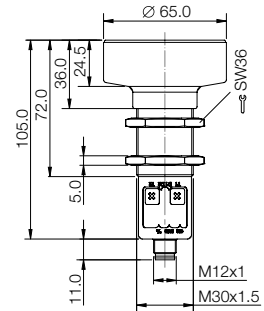
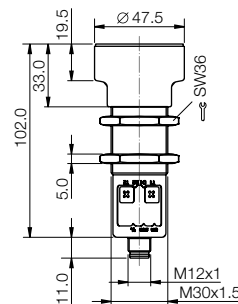
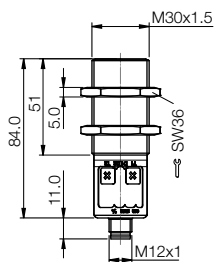

### Suitable connector

Size/style	Length/cable material	Ordering code
M12, 5-pin/straight	5 m/PUR	<b>BCC098C</b>
M12, 5-pin/angled	5 m/PUR	<b>BCC08FC</b>

### Recommended accessories

Description	Ordering code
Mounting cuff	<b>BAM00HN</b>
Mounting clamp	<b>BAM00TN</b>
Mounting bracket	<b>BAM00HH</b>
Sound deflection bracket	<b>BAM01ER</b>

You can find additional electrical accessories in our catalog **Industrial Networking and Connectivity**.

You can find additional mechanical accessories in our catalog **Accessories Line**.

# Ultrasonic Sensors

## M18 tubular-style housing



- **Variant with 90° angled head**  
for individual installation situations
- **IO-Link interface**  
for supporting the new industrial standard
- **Automatic synchronization and multiplex operation**  
for simultaneous operation of up to ten sensors
- **4 scanning ranges with a measuring range from 20 mm to 1.3 m**
- **1 push/pull switching output PNP- or NPN-switching**
- **Analog output 4...20 mA or 0...10 V**  
for analog distance measurements
- **Teach-in via control line (pin 5)**

### Scanning range

Blind zone	
Limiting scanning range	

### BUS M18M switching output, straight

Resolution	
Push/Pull, NO/NC contact, IO-Link	<b>Ordering code</b> Part number

### BUS W18M switching output, angled

Resolution	
Push/Pull, NO/NC contact, IO-Link	<b>Ordering code</b> Part number

### BUS M18M analog output, straight

Resolution (depends on analog window used)	
0...10 V	<b>Ordering code</b>
Rising/falling	Part number
4...20 mA	<b>Ordering code</b>
Rising/falling	Part number

### BUS W18M analog output, angled

Resolution (depends on analog window used)	
0...10 V	<b>Ordering code</b>
Rising/falling	Part number
4...20 mA	<b>Ordering code</b>
Rising/falling	Part number

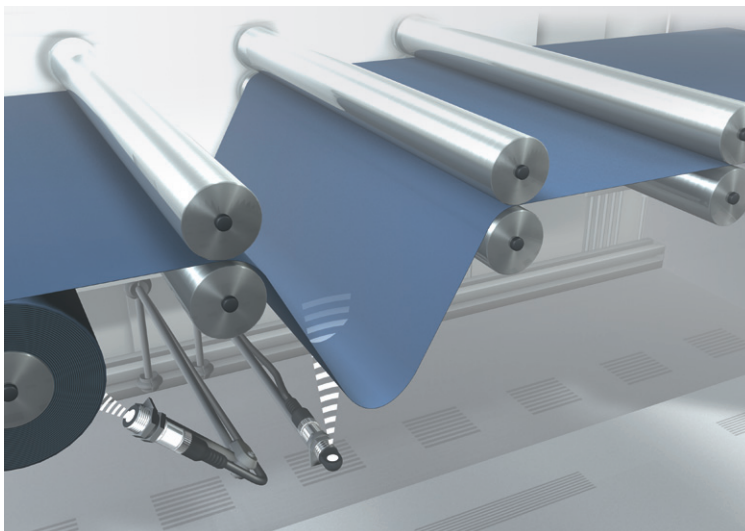

## IO-Link – the new standard

With the IO-Link interface, the prerequisites are filled for gapless communication through all levels of the system architecture all the way to the sensor. Commissioning and maintenance of a machine are simplified and productivity increased.

### Control foil sag and monitor roll diameter

Using an ultrasonic sensor with analog output, the material on a roll or a coil is detected and the roll drive or a brake readjusted. Another sensor with analog output readjusts the material infeed at the dancer roller as a function of the cable loop.

# Ultrasonic Sensors

## M18 tubular-style housing

### General data

Supply voltage	10...30 V DC, polarity reversal protected	
Output current	200 mA	
Accuracy	± 1 % (temperature drift internally compensated)	
Degree of protection as per EN 60529	IP 67	
Operating temperature	-25...+70°C	
Material	Housing	Nickel-plated brass tube, plastic parts: PBT
	Sensing surface	Polyurethane foam, epoxy resin containing glass
Connection	M12 connector, 5-pin	

20...150 mm	30...250 mm	65...350 mm	120...1000 mm
20 mm	30 mm	65 mm	120 mm
250 mm	350 mm	600 mm	1300 mm

0.069 mm	0.069 mm	0.069 mm	0.069 mm
<b>BUS0020</b>	<b>BUS0029</b>	<b>BUS004Z</b>	<b>BUS004P</b>
BUS M18M1-GPXI-02/015-S92G	BUS M18M1-GPXI-03/025-S92G	BUS M18M1-GPXI-07/035-S92G	BUS M18M1-GPXI-12/100-S92G

0.069 mm	0.069 mm	0.069 mm	0.069 mm
<b>BUS0023</b>	<b>BUS002A</b>	<b>BUS004Y</b>	<b>BUS004N</b>
BUS W18M1-GPXI-02/015-S92G	BUS W18M1-GPXI-03/025-S92G	BUS W18M1-GPXI-07/035-S92G	BUS W18M1-GPXI-12/100-S92G

0.069...0.10 mm	0.069...0.10 mm	0.069...0.10 mm	0.069...0.10 mm
<b>BUS0026</b>	<b>BUS0024</b>	<b>BUS004T</b>	<b>BUS0052</b>
BUS M18M1-XA-02/015-S92G	BUS M18M1-XA-03/025-S92G	BUS M18M1-XA-07/035-S92G	BUS M18M1-XA-12/100-S92G
<b>BUS0025</b>	<b>BUS002C</b>	<b>BUS004W</b>	<b>BUS004M</b>
BUS M18M1-XB-02/015-S92G	BUS M18M1-XB-03/025-S92G	BUS M18M1-XB-07/035-S92G	BUS M18M1-XB-12/100-S92G

0.069...0.10 mm	0.069...0.10 mm	0.069...0.10 mm	0.069...0.10 mm
<b>BUS0028</b>	<b>BUS0050</b>	<b>BUS004R</b>	<b>BUS0051</b>
BUS W18M1-XA-02/015-S92G	BUS W18M1-XA-03/025-S92G	BUS W18M1-XA-07/035-S92G	BUS W18M1-XA-12/100-S92G
<b>BUS0027</b>	<b>BUS002E</b>	<b>BUS004U</b>	<b>BUS0053</b>
BUS W18M1-XB-02/015-S92G	BUS W18M1-XB-03/025-S92G	BUS W18M1-XB-07/035-S92G	BUS W18M1-XB-12/100-S92G

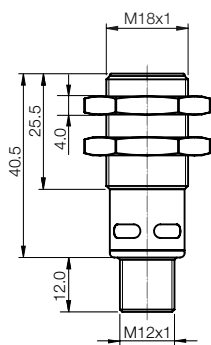

BUS M18...  
straight

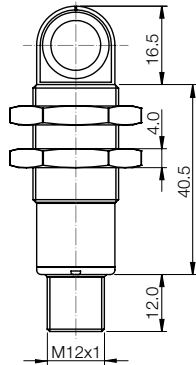

BUS W18...  
angled

### Suitable connector

Size/style	Length/cable material	Ordering code
M12, 5-pin/straight	5 m/PUR	<b>BCC098C</b>
M12, 5-pin/angled	5 m/PUR	<b>BCC08FC</b>

### Recommended accessories

Description	Ordering code
Mounting cuff	<b>BAM00F2</b>
Mounting clamp	<b>BAM00T3</b>
Mounting bracket	<b>BAM00EY</b>
Focusing attachment	<b>BAM01HJ</b>
Sound deflection bracket	<b>BAM01EP</b>

You can find additional electrical accessories in our catalog **Industrial Networking and Connectivity**.

You can find additional mechanical accessories in our catalog **Accessories Line**.

# Ultrasonic Sensors

## R06 block-style housing



- **Small ultrasonic sensor in block-style housing**  
makes possible completely new solutions
- **Same construction as many optical sensors**  
a true alternative in critical applications
- **Option for focusing attachment**  
for challenging measurement tasks
- **5 scanning ranges with a measuring range from 20 mm to 1 m**
- **1 switching output in PNP or NPN design**
- **Analog output 4...20 mA or 0...10 V**
- **Teach-in via a button**

### Scanning range

Blind zone

Limiting scanning range

### BUS R06K switching output

Resolution

PNP, NO/NC contact **Ordering code**  
Part number

NPN, NO/NC contact **Ordering code**  
Part number

PNP, NO/NC contact, 125 Hz **Ordering code**  
Part number

NPN, NO/NC contact, 125 Hz **Ordering code**  
Part number

### BUS R06K analog output

Resolution (depends on window used)

0...10 V **Ordering code**  
Part number

4...20 mA **Ordering code**  
Part number

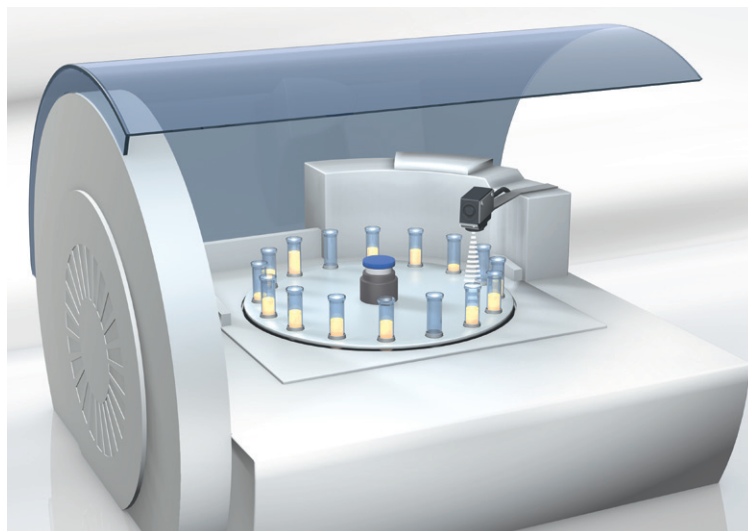

### Focusing attachment

For fill-level measurement through tiny openings with diameters to 5 mm, the sensor with focusing attachment is positioned directly over the measurement location. The tightly bundled sound field is incident exactly on the location that is to be measured.

The blind zone of the sensor lies within the focusing attachment, making measurement possible starting directly from the sound outlet.

**Comment:** Can be used with BUS R06K1...-02/007-.. and BUS R06K1...-02/015-.. for measurements in boreholes and filling levels as well as for scanning circuit boards or highly transparent foils.



### Fill-level measurement in narrow containers

On a rotary indexing table, narrow containers are filled with liquid or solid media. The ultrasonic sensor then checks the exact filling level.

# Ultrasonic Sensors

## R06 block-style housing

### General data

Size	20x32x12 mm	
Supply voltage	20...30 V DC, polarity reversal protected	
Output current	200 mA	
Degree of protection as per EN 60529	IP 67	
Operating temperature	-25...+70°C	
Material	Housing	ABS
	Sensing surface	Polyurethane foam
Connection	M8 connector, 4-pin	

20...70 mm	20...150 mm	55...240 mm	30...250 mm	120...700 mm
20 mm	20 mm	55 mm	30 mm	120 mm
100 mm	250 mm	350 mm	350 mm	1000 mm

0.056 mm	0.056 mm	0.037 mm	0.069 mm	0.037 mm
<b>BUS0021</b>	<b>BUS004C</b>	<b>BUS004L</b>	<b>BUS0057</b>	<b>BUS0059</b>
BUS R06K1-PPX-02/007-S75G	BUS R06K1-PPX-02/015-S75G	BUS R06K1-PPX-05/024-S75G	BUS R06K1-PPX-03/025-S75G	BUS R06K1-PPX-12/070-S75G
<b>BUS004E</b>	<b>BUS004A</b>	<b>BUS0048</b>	<b>BUS0058</b>	<b>BUS005A</b>
BUS R06K1-NPX-02/007-S75G	BUS R06K1-NPX-02/015-S75G	BUS R06K1-NPX-05/024-S75G	BUS R06K1-NPX-03/025-S75G	BUS R06K1-NPX-12/070-S75G
	<b>BUS0049</b>			
	BUS R06K1-PPX-02/015-S75G-F01			
	<b>BUS004H</b>			
	BUS R06K1-NPX-02/015-S75G-F01			

	0.056 mm	0.037...0.072 mm		0.037...0.215 mm
	<b>BUS004K</b>	<b>BUS0056</b>		<b>BUS005E</b>
	BUS R06K1-XA-02/015-S75G	BUS R06K1-XA-05/024-S75G		BUS R06K1-XA-12/070-S75G
	<b>BUS004J</b>	<b>BUS004F</b>		<b>BUS005C</b>
	BUS R06K1-XB-02/015-S75G	BUS R06K1-XB-05/024-S75G		BUS R06K1-XB-12/070-S75G

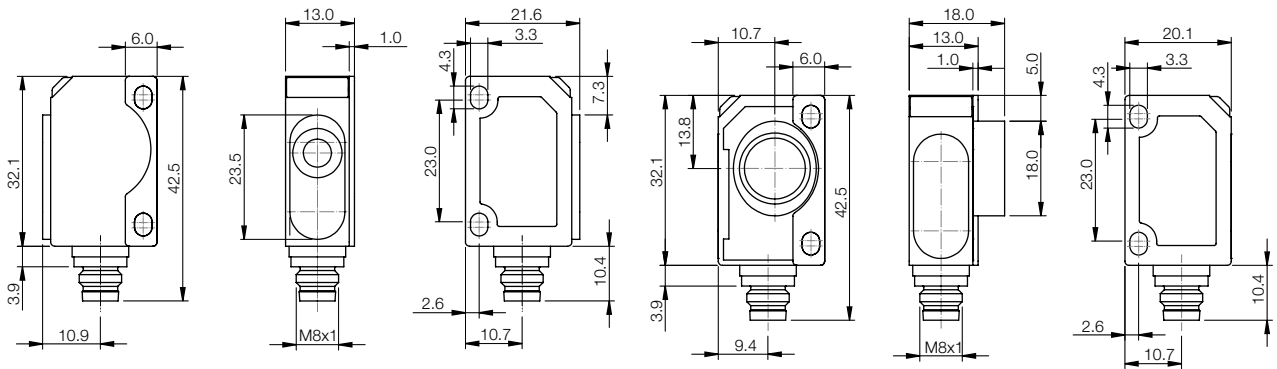

Operating scanning ranges 20–70 mm and 20–150 mm

Operating scanning range 120–700 mm

### Suitable connector

Size/style	Length/cable material	Ordering code
M8, 4-pin/straight	2 m/PUR	<b>BCC02N2</b>
M8, 4-pin/straight	2 m/PVC	<b>BCC02PL</b>
M8, 4-pin/angled	2 m/PUR	<b>BCC02NC</b>
M8, 4-pin/angled	2 m/PVC	<b>BCC02PZ</b>

### Recommended accessories

Description	Ordering code
Mounting tab	<b>Included</b>
Focusing attachment	<b>BAM01YU</b>
Mounting bracket	<b>BAM00UH</b>

You can find additional electrical accessories in our catalog **Industrial Networking and Connectivity**.

You can find additional mechanical accessories in our catalog **Accessories Line**.

# Ultrasonic Sensors

## M12 tubular-style housing

- Stainless steel housing
- Measuring range from 25 mm to 200 mm
- 1 switching output in PNP or NPN design
- Teach-in via line (PIN 2)



### General data

Supply voltage	18...30 V DC, polarity reversal protected	
Output current	100 mA	
Resolution	0.2 mm	
Degree of protection as per EN 60529	IP 65	
Operating temperature	-20...+70°C	
Material	Housing	V2A, plastic parts: PA
	Sensing surface	Epoxy resin - hollow-glass sphere /PUR
Connection	M12 connector, 4-pin	

<b>Scanning range</b>	<b>25...200 mm</b>
Blind zone	25 mm

### BUS M12E switching output

PNP,	<b>Ordering code</b>	<b>BUS0005</b>
NO/NC contact	Part number	BUS M12E0-PPXCR-020-S04G
NPN,	<b>Ordering code</b>	<b>BUS0006</b>
NO/NC contact	Part number	BUS M12E0-NPXCR-020-S04G

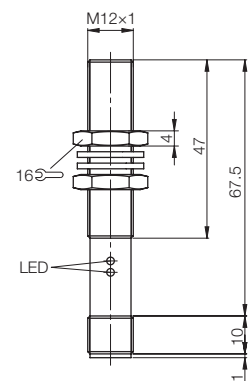

### Suitable connector

Size/style	Length/cable material	Ordering code
M12, 4-pin/straight	2 m/PUR	<b>BCC032F</b>
M12, 4-pin/straight	5 m/PUR	<b>BCC032H</b>
M12, 4-pin/angled	2 m/PUR	<b>BCC032Y</b>
M12, 4-pin/angled	5 m/PUR	<b>BCC032Z</b>

### Recommended accessories

Description	Ordering code
Mounting cuff	<b>BAM00C4</b>
Mounting clamp	<b>BAM01KM</b>
Mounting bracket	<b>BAM00C0</b>
Focusing attachment	<b>BAM01ET</b>

You can find additional electrical accessories in our catalog **Industrial Networking and Connectivity**.

You can find additional mechanical accessories in our catalog **Accessories Line**.



### Monitoring of packages

High hygienic requirements in the food industry place special demands on sensor technology. The ultrasonic sensor reliably monitors the proper sealing of packages and thereby ensures uniform quality.

# Ultrasonic Sensors Q80 block-style housing



- Measuring range from 600 mm to 6000 mm
- 2 switching outputs in PNP- or NPN-design
- Analog output 4...20 mA or 0...10 V
- Teach-in via line (PIN 5)

## General data

Supply voltage	18...30 V DC, polarity reversal protected	
Output current	500 mA	
Resolution	1 mm	
Degree of protection as per EN 60529	IP 65	
Operating temperature	-15...+70°C	
Material	Housing	PBT
	Sensing surface	Epoxy resin - hollow-glass sphere /PUR
Connection	M12 connector, 5-pin	

<b>Scanning range</b>	<b>600...6000 mm</b>
Blind zone	600 mm

## BUS Q80K switching output

2x PNP, NO/NC contact	<b>Ordering code</b>	<b>BUS000A</b>
	Part number	BUS Q80K0-PWXER-600-S92K
2x NPN, NO/NC contact	<b>Ordering code</b>	<b>BUS000C</b>
	Part number	BUS Q80K0-NWXER-600-S92K

## BUS Q80K analog output

0...10 V	<b>Ordering code</b>	<b>BUS000E</b>
	Part number	BUS Q80K0-XAER-600-S92K
4...20 mA	<b>Ordering code</b>	<b>BUS000F</b>
	Part number	BUS Q80K0-XBER-600-S92K

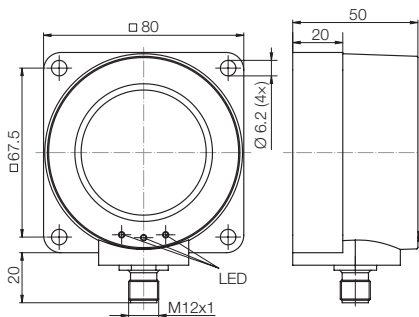

## Suitable connector

Size/style	Length/cable material	Ordering code
M12, 5-pin/straight	5 m/PUR	<b>BCC098C</b>
M12, 5-pin/angled	5 m/PUR	<b>BCC08FC</b>

You can find additional electrical accessories in our catalog  
**Industrial Networking and Connectivity.**

## Fill-level monitoring in silos

The fill level of bulk materials in a container is detected by a continuous measurement with ultrasonic sensors. The fill level can optionally be output by an analog signal or with two switching signals – as min./max. value.





Object Detection



Linear Position Sensing



Fluid Sensors



Industrial Identification



Industrial Networking and Connectivity



Accessories



Service

Balluff GmbH  
Schurwaldstrasse 9  
73765 Neuhausen a.d.F.  
Germany  
Phone +49 7158 173-0  
Fax +49 7158 5010  
balluff@balluff.de

