

---

# Capacitive proximity sensors

## OsiSense XT

### Catalogue

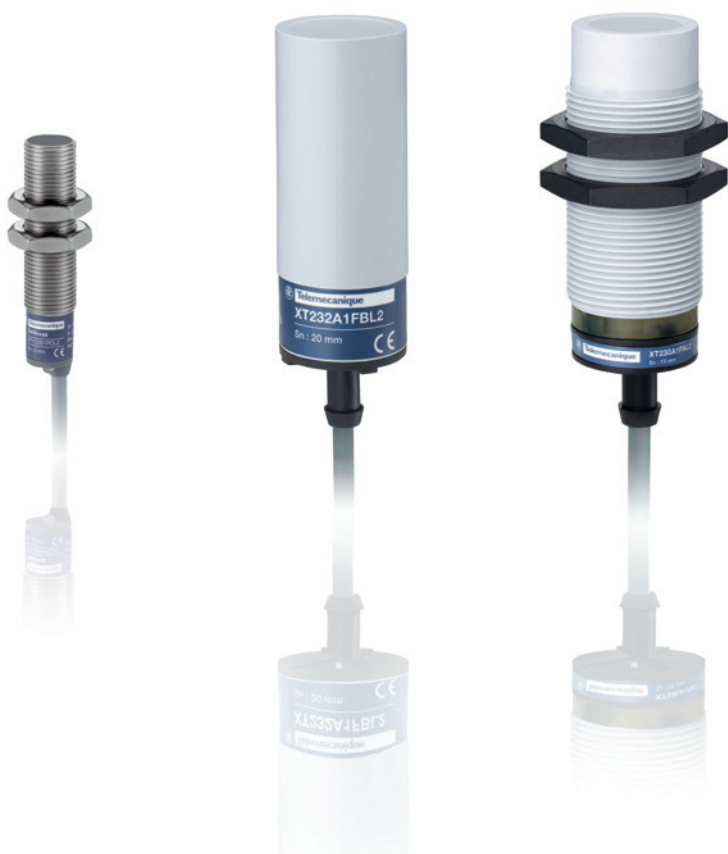

Simply easy!™



# Capacitive proximity sensors OsiSense XT

---

**Selection guide** ..... **page 2**

- General ..... **page 4**
- Cylindrical, flush mountable. Metal case..... **page 8**
- Cylindrical, non flush mountable. Plastic case..... **page 12**
- Accessories ..... **page 12**
- 40 x 40 x 117 format. Plastic case, plug in. Turret head ..... **page 16**
- Product reference index..... **page 18**

# Capacitive proximity sensors

## OsiSense XT

Detection of insulated or conductive materials

Applications: detection of any object irrespective of material or conductivity, for example: metals, minerals, wood, plastic, glass, cardboard, fluids, etc.

### Cylindrical sensors, flush mountable, metal case

Detection of insulated or conductive materials: presence, passage of paper, cardboard, glass, etc.



Form	Cylindrical
	Block, dimensions (w x h x d) in mm
Case	
Sensing distance (Sn) in mm	Flush mountable in metal sensors
	Non flush mountable in metal sensors
Degree of protection	
Supply	—
	~
Connection	Pre-cabled
	Connector
	Screw terminals
Type reference	
Pages	

Threaded: M12 x 1	Threaded: M18 x 1	Threaded: M30 x 1.5	Plain: Ø 32
–	–	–	–
Stainless steel	Nickel plated brass	Nickel plated brass	Nickel plated brass
2	5	10	15
–	–	–	–
IP 67	IP 67	IP 67	IP 67
IP 65 for sensors with connector	IP 65 for sensors with connector	IP 65 for sensors with connector	IP 65 for sensors with connector
•	•	•	–
–	•	•	•
•	–	–	–
•	•	•	–
–	–	–	–
<b>XT112S1●</b>	<b>XT118B1●</b>	<b>XT130B1●</b>	<b>XT132B1●</b>
8	8	8	8

**Cylindrical sensors, non flush mountable, plastic case**

**Block type sensors, flush mountable in support, plastic case**

Detection of insulated or conductive materials  
Liquid level control

Application series:  
Automatic feed system  
for livestock

Detection of insulated materials:  
presence, passage of paper, cardboard, glass,  
etc.



Threaded: M18 x 1	Threaded: M30 x 1.5	Plain: Ø 32	Threaded: M30 x 1.5	–
–	–	–	–	40 x 40 x 117 format
Plastic	–	–	–	Plastic, turret head
–	–	–	–	15
8	15	20	15	–
IP 67, double insulation			IP 65, double insulation	IP 67
•	•	–	•	•
•	–	–	•	•
•	–	–	–	–
•	•	–	–	–
–	–	–	•	•
<b>XT218A1●</b>	<b>XT230A1●</b>	<b>XT232A1●</b>	<b>XT230A2MDB</b>	<b>XT7C40●</b>
12	–	–	–	16

### Presentation

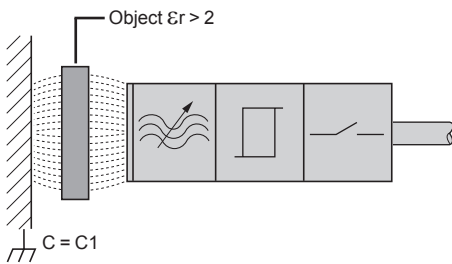
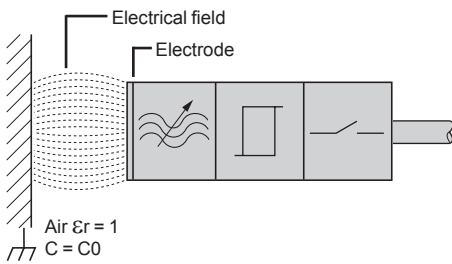

### Advantages

- No physical contact with the object to be detected.
- High operating rates.
- Solid-state product, no moving parts (service life not related to number of operating cycles).
- Detection of any object irrespective of material or conductivity, for example: metals, minerals, wood, plastic, glass, cardboard, leather, ceramic, fluids, etc.

### Operating principle

An electrical field is created between 2 electrodes on the front face of the sensor. These electrodes constitute a capacitor with a capacitance of:

$$C = \epsilon_0 * \epsilon_r * A/d \text{ where:}$$

$$\epsilon_0 = 8.854\ 187 \text{ pF/m (permittivity in free space)}$$

$\epsilon_r$ : relative permittivity of the material present between the 2 electrodes

A: dimensions of electrodes

d: distance between electrodes

All materials where  $\epsilon_r > 2$  will be detected.

When an object of any material ( $\epsilon_r > 2$ ) passes the sensing face of the sensor, it modifies the coupling capacitance ( $C1$ ).

This variation in capacitance ( $C1 > C0$ ) instigates the starting of the oscillator which, in turn, causes the output driver to operate and provides an output signal.

### Types of sensor

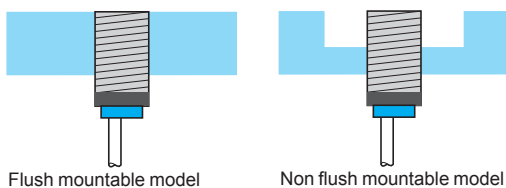
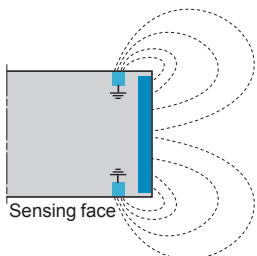
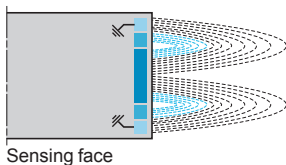

### Sensors flush mountable in support

The special feature of these versions is the shape of the electrical field which is rectilinear and confined within the dimensions of the product.

Cylindrical and block type models used for the detection of insulated materials (wood, plastic, cardboard, glass...), conductive materials (metal...) or liquid through an insulated partition (glass, plastic...) with a maximum thickness of 4 mm.

These products are recommended for:

- comparatively short detection distances,
- applications requiring flush mounting of the sensor,
- detection through a partition (example: detection of glass through cardboard),
- side by side mounting.

### Sensors non flush mountable in support

Cylindrical models (plastic case).

The spherical shape of the electrical field enables detection of any type of material whether it be solid, liquid, granular... (metal, water, oil, plastic pellets, powder, flour...). Detection can be achieved through a partition or by direct contact (immersion) of the active surface with the object to be detected.

Distances to be adhered to around the sensing face. (See characteristics page 15).

### Mounting precautions

Non flush mountable models cannot be flush mounted in their support. The non flush mountable models require a free zone around the active head. (See page 15).

### Terminology

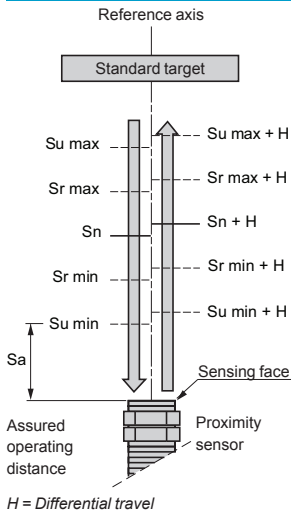

### Definitions

In order to ensure that customers can make reliable product comparisons and selection, the standard IEC 60947-5-2 defines various sensing distances, such as:

#### Nominal sensing distance (Sn)

The rated operating distance for which the sensor is designed. It does not take into account any variations (manufacturing tolerances, temperature, voltage).

#### Effective sensing distance (Sr)

The effective sensing distance is measured at the rated voltage ( $U_n$ ) and the rated ambient temperature ( $23\text{ °C} \pm 5\text{ °C}$ ). It must be between 90% and 110% of  $S_n$ .

#### Usable sensing distance (Su)

The usable sensing distance is measured at the limits of the permissible variations in the ambient temperature and at a supply voltage equal to 85% and 110% of the rated voltage. It must be between 80% and 120% of  $S_r$ .

#### Assured operating distance (Sa)

This is the operating zone of the sensor. The assured operating distance is between 0 and 72% of  $S_n$ .

### Standard metal target

The standard IEC 60947-5-2 defines the standard metal target as a square mild steel (Fe 360) plate, 1 mm thick.

The side dimension of the plate is either equal to the diameter of the circle engraved on the sensing face of the sensor or 3 times the nominal sensing distance ( $S_n$ ).

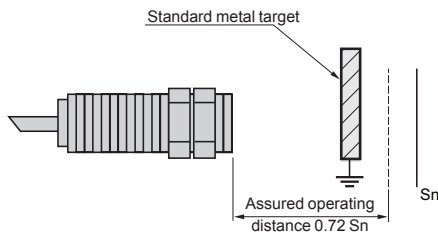

### Repeat accuracy

The repeat accuracy ( $R$ ) is the repeatability of the sensing distance between successive operations. Readings are taken over a period of time whilst the sensor is subjected to voltage and temperature variations: 8 hours, 10 to 30 °C,  $U_n \pm 5\%$ . It is expressed as a percentage of the effective sensing distance  $S_r$ .

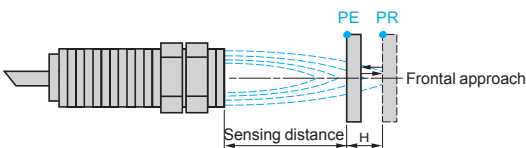

PE = pick-up point, the target is detected  
PR = drop-out point, the target is no longer detected

### Differential travel

The differential travel ( $H$ ) or hysteresis, is the distance between the operating point, as the standard metal target moves towards the sensor, and the release point, as it moves away.

This hysteresis is essential for the stable operation of the sensor.

### Terminology (continued)

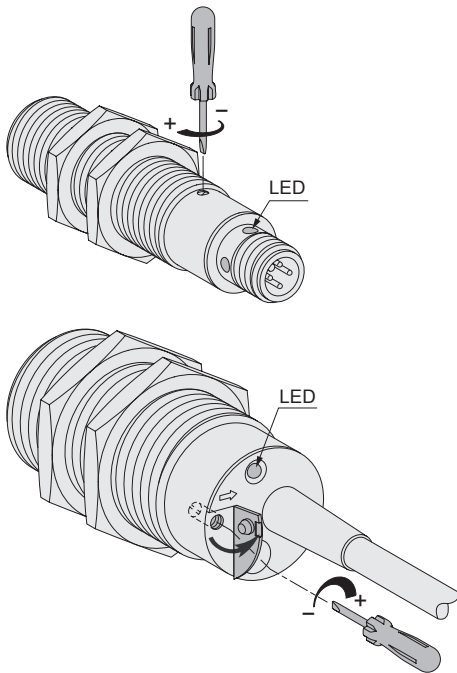

### Sensitivity of the sensor

All our sensors incorporate a sensitivity adjustment potentiometer. This enables the sensitivity of the sensor to be adjusted to suit the type of object to be detected.

Depending on the sensor version, the sensitivity adjustment potentiometer is either mounted on the side or the rear.

The sensors are factory preset for nominal sensitivity.

Depending on the application, adjustment of the sensitivity could be necessary as follows:

- increasing the sensitivity for objects which have a weak influence (weaker): paper, cardboard, glass, plastic,
- decreasing the sensitivity for objects which have a strong influence (stronger): metals, liquids.

However, in the event of severe variations in the ambient conditions, do not increase the sensitivity of the sensor such that it is set to its maximum operating limits.

An increase in sensitivity causes an increase in the switching hysteresis.

### Operating distances

The operating distance of the sensor is related to the dielectric constant ( $\epsilon_r$ ) of the object material to be detected.

The higher the value of  $\epsilon_r$ , the easier the detection of the object will be.

The assured operating distance depends on the object material:  $S_a = S_n \times F_c$

$S_a$  = assured operating distance,

$S_n$  = nominal sensing distance of the sensor,

$F_c$  = correction factor related to the object material.

Example: sensor XT130B1PAL2 used to detect a rubber object.

$S_n = 10 \text{ mm}$ ,  $F_c = 0.3$ .

Assured operating distance  $S_a = 10 \times 0.3 \text{ mm}$ .

The list below indicates the dielectric constant values of the most common object materials, together with their correction factors ( $F_c$ ) for the nominal sensing distance of the sensor.

Material	$\epsilon_r$	$F_c$	Material	$\epsilon_r$	$F_c$
Air	1	0	Petrol	2.2	0.2
Acetone	20	0.8	Plexiglass	3.2	0.3
Alcohol	24	0.85	Polyester resin	2.8...8	0.2...0.6
Ammonia	15...25	0.75...0.85	Polystyrene	3	0.3
Cement (powder)	4	0.35	Porcelain	5...7	0.4...0.5
Cereals	3...5	0.3...0.4	Powdered milk	3.5...4	0.3...0.4
Epoxy resin	4	0.36	Rubber	2.5...3	0.3
Ethylene glycol	38	0.95	Sand	3...5	0.3...0.4
Flour	2.5...3	0.2...0.3	Salt	6	0.5
Glass	3...10	0.3...0.7	Sugar	3	0.3
Marble	6...7	0.5...0.6	Teflon	2	0.2
Mica	6...7	0.5...0.6	Vaseline	2...3	0.2...0.3
Nylon	4...5	0.3...0.4	Water	80	1
Oil	2.2	0.2	Wood (damp)	10...30	0.7...0.9
Paper	2...4	0.2...0.3	Wood (dry)	2...7	0.2...0.6
Paraffin	2...2.5	0.2			



### Environment

■ **Electromagnetic interference**

The sensors undergo electromagnetic interference testing in accordance with the recommendations of standard IEC 60947-5-2 (electrostatic discharges, radiated electromagnetic fields, fast transients, impulse voltages).

■ **Thermal influences**

It is advisable to remain within the values stated on the characteristic pages so as to avoid sensing distance drift and possible incorrect operation of the sensor.

■ **Chemical agents**

To ensure a long service life, it is essential that any chemicals coming into contact with the case of the sensor are non corrosive.

■ **Earthing**

Earthing of an object that has high conductivity increases the sensing distance.

### Additional information relating to outputs

Refer to corresponding pages relating to inductive proximity sensors for:

- Terminology.
- Details and specific aspects of 2-wire and 3-wire type connection.
- Connecting several sensors in series or parallel.

### Application examples:

#### Bottle filling

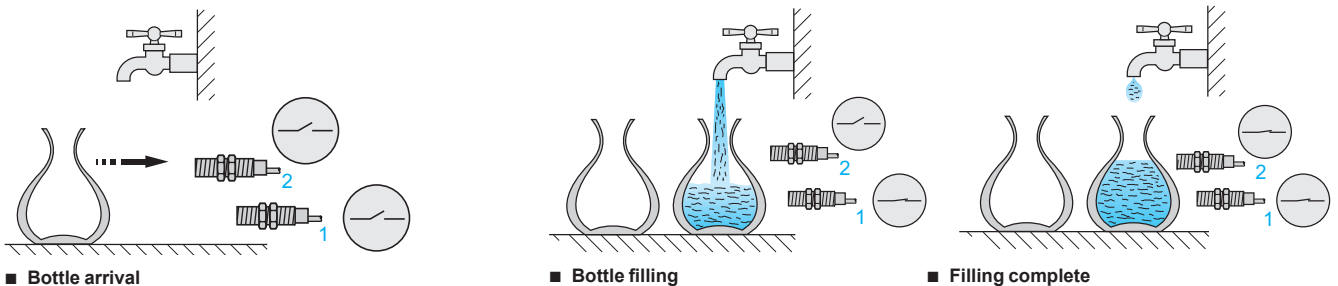

■ **Bottle arrival**

- Bottles are fed on a conveyor for filling. Sensors 1 and 2 are in an unoperated state.
- Adjustment:
  - sensor 1 is adjusted to detect the bottle,
  - sensor 2 is adjusted to detect the water in the bottle.

■ **Bottle filling**

As soon as the bottle enters the detection zone of sensor 1, the filling operation commences. Sensor 2 remains in the unoperated state.

■ **Filling complete**

Sensor 2 detects that the required level has been reached and stops further filling.

**Reminder: the wall of the container must be non metallic and its thickness  $\leq 4$  mm**

#### Livestock feeder filling

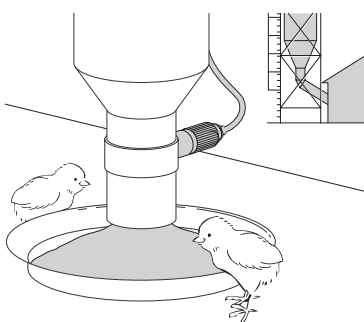

Capacitive technology is particularly suited for the detection of feed levels in automatic dispensers for livestock. Any type of feed can be detected (pellets, powders, broths, grains, pastas, etc.). The materials used, as well as the degree of protection of the sensor, have been specially selected to tolerate the acidic and dusty environments associated with this application.

# Capacitive proximity sensors

## OsiSense XT

Cylindrical, flush mountable. Metal case

AC or DC supply

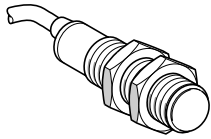

XT112S1●●L2

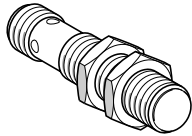

XT112S1PCM12

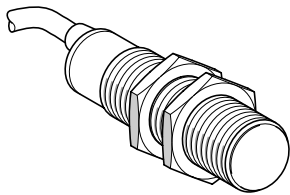

XT118B1●●L2

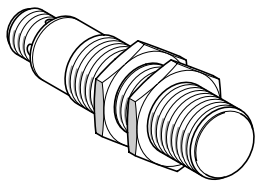

XT118B1PCM12

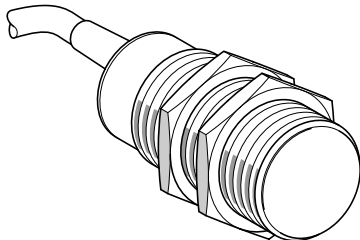

XT130B1●●L2

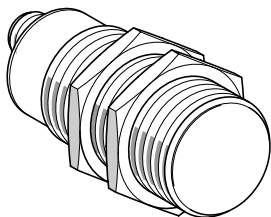

XT130B1PCM12

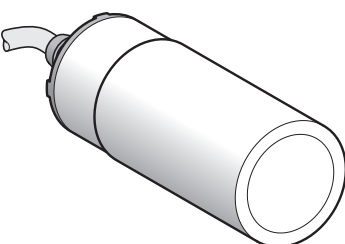

XT132B1F●L2

### Ø 12, threaded M12 x 1, stainless steel

Sensing distance (Sn) (mm)	Function	Output	Connection	Reference	Weight kg
----------------------------	----------	--------	------------	-----------	-----------

#### 4-wire --- 24 V

2	NO/NC	PNP	Pre-cabled (L = 2 m)	XT112S1PCL2	0.070
			M12 connector	XT112S1PCM12	0.040

#### 3-wire --- 24 V

2	NO	PNP	Pre-cabled (L = 2 m)	XT112S1PAL2	0.070
		NPN	Pre-cabled (L = 2 m)	XT112S1NAL2	0.070

### Ø 18, threaded M18 x 1, nickel plated brass

Sensing distance (Sn) (mm)	Function	Output	Connection	Reference	Weight kg
----------------------------	----------	--------	------------	-----------	-----------

#### 4-wire --- 24 V

5	NO/NC	PNP	Pre-cabled (L = 2 m)	XT118B1PCL2	0.150
			M12 connector	XT118B1PCM12	0.075

#### 3-wire --- 24 V

5	NO	PNP	Pre-cabled (L = 2 m)	XT118B1PAL2	0.150
		NPN	Pre-cabled (L = 2 m)	XT118B1NAL2	0.150

#### 2-wire ~ 24-240 V

5	NO	–	Pre-cabled (L = 2 m)	XT118B1FAL2	0.150
	NC	–	Pre-cabled (L = 2 m)	XT118B1FBL2	0.150

### Ø 30, threaded M30 x 1.5, nickel plated brass

Sensing distance (Sn) (mm)	Function	Output	Connection	Reference	Weight kg
----------------------------	----------	--------	------------	-----------	-----------

#### 4-wire --- 24 V

10	NO/NC	PNP	Pre-cabled (L = 2 m)	XT130B1PCL2	0.270
			M12 connector	XT130B1PCM12	0.150

#### 3-wire --- 24 V

10	NO	PNP	Pre-cabled (L = 2 m)	XT130B1PAL2	0.270
		NPN	Pre-cabled (L = 2 m)	XT130B1NAL2	0.270

#### 2-wire ~ 24-240 V

10	NO	–	Pre-cabled (L = 2 m)	XT130B1FAL2	0.270
	NC	–	Pre-cabled (L = 2 m)	XT130B1FBL2	0.270

### Ø 32, plain, nickel plated brass (1)

Sensing distance (Sn) (mm)	Function	Output	Connection	Reference	Weight kg
----------------------------	----------	--------	------------	-----------	-----------

#### 2-wire ~ 24-240 V

15	NO	–	Pre-cabled (L = 2 m)	XT132B1FAL2	0.400
	NC	–	Pre-cabled (L = 2 m)	XT132B1FBL2	0.400

(1) Mounting accessory included with sensor.

### Accessories

Fixing and protection accessories, fuses and fuse terminal block: see page 12.

# Capacitive proximity sensors

OsiSense XT

Cylindrical, flush mountable. Metal case

AC or DC supply

Characteristics								
Sensor type		M12	M18	M30		Ø 32		
		XT112●	XT118●	XT130●	XT132●			
		3-wire ⎓ 4-wire ⎓	3-wire ⎓ 4-wire ⎓	2-wire ~	3-wire ⎓ 4-wire ⎓	2-wire ~	2-wire ~	
Product certifications		CE, cETLus					CE, cULus	
Conformity to standards		IEC 60947-5-2, UL 61010-1						
Connection	Pre-cabled, length 2 m	●	●	●	●	●	●	
	Connector, M12	●	●	–	●	–	–	
Main characteristics								
Nominal sensing distance (Sn)	Conforming to IEC 60947-5-2	mm	2	5	10	15	15	
Assured operating distance Sa	Conforming to IEC 60947-5-2	mm	0...1.44	0...3.60	0...3.60	0...7.2	0...11	
Adjustment zone		mm	0.5...5	1...8	1...5	2...20	2...15	
Repeat accuracy			< 0.1 Sr				< 0.15 Sr	
Differential travel			< 0.2 Sr				< 0.2 Sr	
Output characteristics								
Output state indication		Yellow LED						
Switching capacity		mA	200	200	330	200	330	
Maximum switching frequency		Hz	300	200	25	150	25	
Protection against short-circuits			●	●	– (1)	●	– (1)	
Voltage drop		V	≤ 2	≤ 2	≤ 6	≤ 2	≤ 6	
Residual current, open state		mA	< 0.1	< 0.1	< 5	< 0.1	< 5	
Delays	First-up	ms	≤ 30	≤ 30	≤ 100	≤ 30	≤ 100	
	Response	ms	≤ 5	≤ 5	≤ 20	≤ 5	≤ 20	
	Recovery	ms	≤ 5	≤ 5	≤ 20	≤ 5	≤ 20	
Supply								
Rated supply voltage		V	⎓ 24	⎓ 24	~ 24 - 240 50/60 Hz	⎓ 24	~ 24 - 240 50/60 Hz	
Voltage limits (including ripple)		V	⎓ 12 - 30	⎓ 12 - 30	~ 20 - 264 50/60 Hz	⎓ 12 - 30	~ 20 - 264 50/60 Hz	
Current consumption, no-load		mA	< 15	< 15	< 3	< 15	< 4	
Protection against reverse polarity			Yes	Yes	–	Yes	–	
Environment								
Materials	Case		Stainless steel 303	Nickel plated brass				
	Cable		PVC					
	Number and c.s.a. of wires		3 x 0.14 mm <sup>2</sup> or 4 x 0.14 mm <sup>2</sup>	3 x 0.34 mm <sup>2</sup> or 4 x 0.34 mm <sup>2</sup>	3 x 0.34 mm <sup>2</sup>	3 x 0.75 mm <sup>2</sup> or 4 x 0.5 mm <sup>2</sup>	3 x 0.75 mm <sup>2</sup>	3 x 0.34 mm <sup>2</sup>
Degree of protection	Conforming to IEC 60529 and IEC 60947-5-2		IP 67 (2) IP 65 for sensors XT112S1PCM12 and XT118B1PCM12				IP 67	
Storage and operating temperature		°C	- 25...+ 70					
Vibration resistance	Conforming to IEC 60068-2-6		10 gn, ± 1 mm (f = 10...55 Hz)					
Shock resistance	Conforming to IEC 60068-2-27		30 gn, 11 ms				30 gn, 6 ms	
Resistance to electromagnetic interference								
Electrostatic discharges	Conforming to IEC 61000-4-2	kV	8 (air) / 4 (contact)					
Radiated electromagnetic fields	Conforming to IEC 61000-4-3	V/m	3					
Fast transients	Conforming to IEC 61000-4-4	kV	2					

(1) These sensors do not incorporate overload or short-circuit protection and therefore, it is essential to connect a "quick-blow" fuse in series with the load (see page 12).

(2) With adjustment potentiometer sealing screw.

# Capacitive proximity sensors

OsiSense XT

Cylindrical, flush mountable. Metal case

AC or DC supply

## Dimensions

**M12, pre-cabled**  
XT112S1●●L2

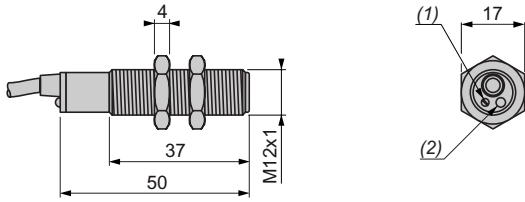

**M12, M12 connector**  
XT112S1PCM12

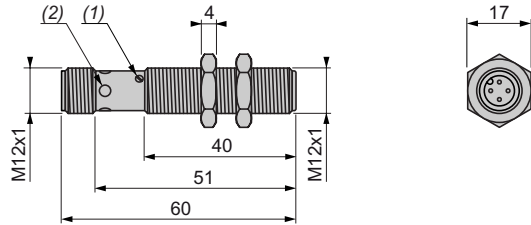

**M18, pre-cabled**  
XT118B1●●L2

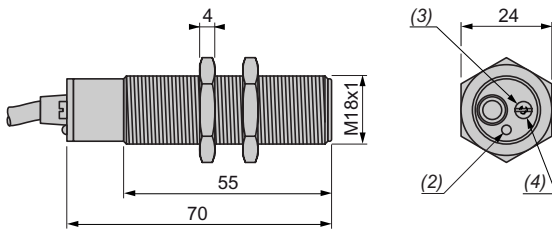

**M18, M12 connector**  
XT118B1PCM12

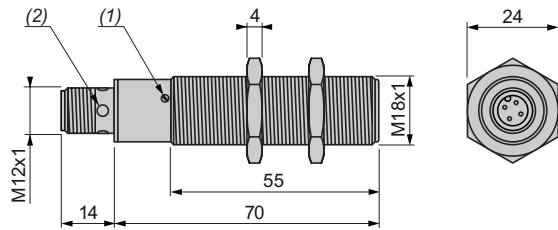

**M30, pre-cabled**  
XT130B1●●L2

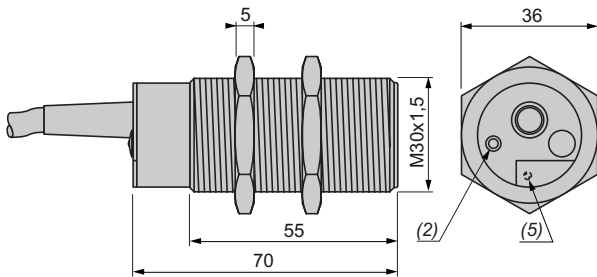

**M30, M12 connector**  
XT130B1PCM12

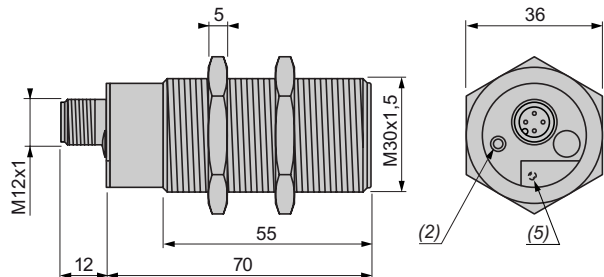

**Ø 32, plain, pre-cabled**  
XT132B1F●L2

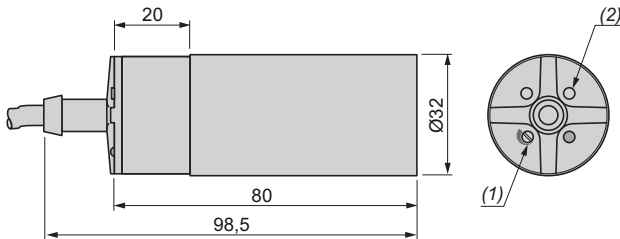

**Mounting accessory (included with sensor XT132B1F●L2)**

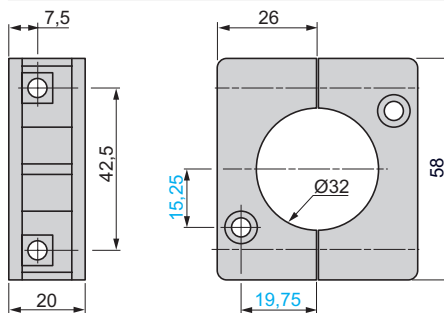

- (1) Adjustment potentiometer
- (2) LED
- (3) Sealing screw
- (4) Potentiometer beneath sealing screw
- (5) Potentiometer beneath protective flap

# Capacitive proximity sensors

OsiSense XT

Cylindrical, flush mountable. Metal case

AC or DC supply

## Wiring schemes

### Connector version

M12 connector

4-wire ~, PNP  
NO + NC output, M12

XT112/18/30●●●●M12

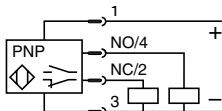

### Pre-cabled version

Cable

4-wire ~, PNP  
NO + NC output, pre-cabled

XT112/18/30PC●●L2

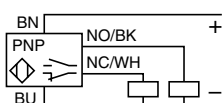

3-wire ~, PNP  
NO output, pre-cabled

XT112/18/30PA●●L2

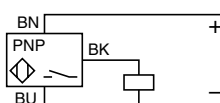

3-wire ~, NPN  
NO output, pre-cabled

XT112/18/30NA●●L2

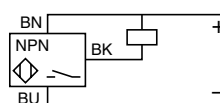

BU: Blue  
BN: Brown  
BK: Black  
WH: White  
YE/GN: Yellow/green

2-wire ~  
NO output

XT118/30/32B1FAL2

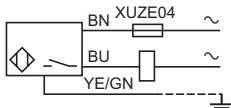

2-wire ~  
NC output

XT118/30/32B1FBL2

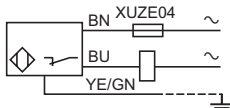

## Adjustment

### Sensitivity adjustment

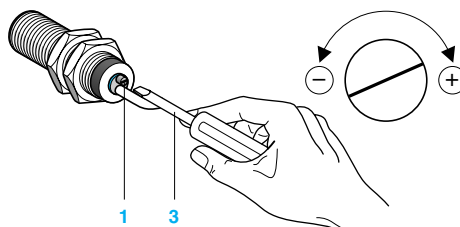
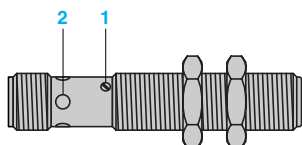

- 1 Adjustment potentiometer LED
- 2 Adjustment using suitable screwdriver (included with sensor)
- 3 Adjustment using suitable screwdriver (included with sensor)

Adjustment from the side for XT112●●●●M12  
XT118●●●●M12

Adjustment from the rear for XT1●●●●L2  
XT130●●●●M12

## Setting-up

Minimum mounting distances (mm)

Side by side

Face to face

Facing a metal object

Mounted in support

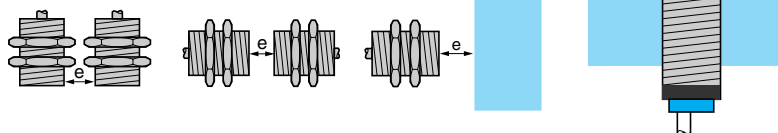

XT1M12 flush mountable	$e \geq 0$	$e \geq 2.2 \times S_n$	$e \geq 2 \times S_n$	–
XT1M18 flush mountable	$e \geq 0$	$e \geq 2.2 \times S_n$	$e \geq 2 \times S_n$	–
XT1M30 flush mountable	$e \geq 0$	$e \geq 2.2 \times S_n$	$e \geq 2 \times S_n$	–

Fixing nut tightening torque: XT112: 10 N.m, XT118: 28 N.m, XT130: 40 N.m

# Capacitive proximity sensors

## OsiSense XT

Cylindrical, non flush mountable. Plastic case

AC or DC supply

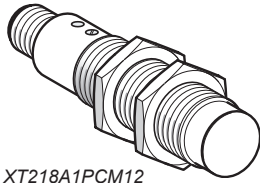

XT218A1PCM12

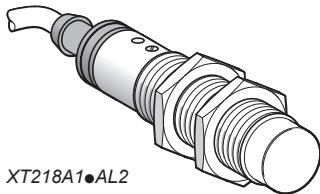

XT218A1AL2

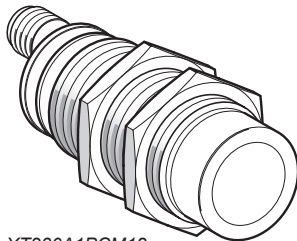

XT230A1PCM12

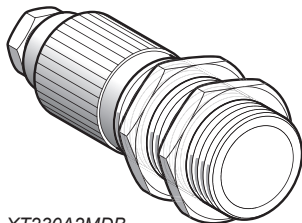

XT230A2MDB

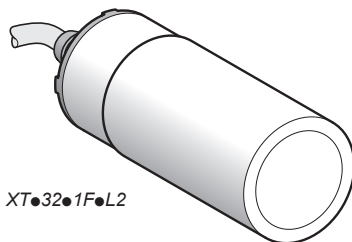

XT321FL2



XUZA118

### Ø 18, threaded M18 x 1

Sensing distance (Sn) (mm)	Function	Output	Connection	Reference	Weight kg
<b>4-wire ~ 12...24 V</b>					
8	NO/NC	PNP	M12 connector	XT218A1PCM12	0.060
<b>3-wire ~ 12...24 V</b>					
8	NO	PNP	Pre-cabled (L = 2 m)	XT218A1PAL2	0.140
		NPN	Pre-cabled (L = 2 m)	XT218A1NAL2	0.140
<b>2-wire ~ 24-240 V</b>					
8	NO	-	Pre-cabled (L = 2 m)	XT218A1FAL2	0.140

### Ø 30, threaded M30 x 1.5

Sensing distance (Sn) (mm)	Function	Output	Connection	Reference	Weight kg
<b>4-wire ~ 12...24 V</b>					
15	NO/NC	PNP	M12 connector	XT230A1PCM12	0.100
<b>3-wire ~ 12...24 V</b>					
15	NO	PNP	Pre-cabled (L = 2 m)	XT230A1PAL2	0.200
		NPN	Pre-cabled (L = 2 m)	XT230A1NAL2	0.200
<b>2-wire ~ 24-240 V</b>					
15	NO	-	Pre-cabled (L = 2 m)	XT230A1FAL2	0.200
	NC	-	Pre-cabled (L = 2 m)	XT230A1FBL2	0.200

### Ø 30, threaded M30 x 1.5, Application series

Sensing distance (Sn) (mm)	Function	Connection	Reference	Weight kg
<b>2-wire ~ 24-240 V / ~ 24 V</b>				
0...15, adjustable	NO or NC, selectable	Screw terminals	XT230A2MDB	0.100

Applications: sensor XT230A2MDB is particularly suited to automatic feed systems for livestock. It enables detection of the level of all types of feed: pellets, grains, pastas, broths and powders.

### Ø 32, plain (1)

Sensing distance (Sn) (mm)	Function	Connection	Reference	Weight kg
<b>2-wire ~ 24-240 V</b>				
20	NO	Pre-cabled (L = 2 m)	XT232A1FAL2	0.350
	NC	Pre-cabled (L = 2 m)	XT232A1FBL2	0.350

(1) Mounting accessory included with sensor.

### Accessories for capacitive sensors XT1 and XT2

#### Fixing accessories

Description	For use with sensor	Reference	Weight kg
90° fixing bracket	Ø 12	XXZ12	0.025
	Ø 18	XUZA118	0.045
	Ø 30	XXZ30	0.115

#### Protection accessories

Description	For use with sensor	Reference	Weight kg
Threaded sleeve	Ø 30, threaded M30 x 1.5	XTAZ30	0.035

#### Fuses (for unprotected 2-wire ~ sensors)

Description	Type	Sold in lots of	Unit reference	Weight kg
Cartridge fuses 5 x 20	0.4 A "quick-blow"	10	XUZE04	0.001
	0.63 A "quick-blow"	10	XUZE06	0.001
	0.8 A "quick-blow"	10	XUZE08	0.001

#### Fuse terminal block

Description	Sold in lots of	Unit reference	Weight kg
Fuse terminal block for 5 x 20 fuses, grey	50	AB1FUSE435U5X	0.016

# Capacitive proximity sensors

OsiSense XT

Cylindrical, non flush mountable. Plastic case

AC or DC supply

Characteristics										
Sensor type		M18			M30			Ø 32		
		XT218A1			XT230A1			XT230A2	XT232A	
		4-wire ---	3-wire ---	2-wire ~	4-wire ---	3-wire ---	2-wire ~	2-wire ~	2-wire ~	
Product certifications		CE, cULus								
Conformity to standards		IEC 60947-5-2, UL 61010-1								
Connection	Pre-cabled, length 2 m	-	•	•	-	•	•	-	•	
	Connector, M12	•	-	-	•	-	-	-	-	
	Screw terminals, 2 x M3	-	-	-	-	-	-	•	-	
<b>Main characteristics</b>										
Nominal sensing distance (Sn)	IEC 60947-5-2	mm	8			15			15	20
Assured operating distance (Sa)	IEC 60947-5-2	mm	0...5.8			0...11			0...11	0...15
Adjustment zone		mm	0...12			0...17			0...17	0...22
Repeat accuracy		Sr	< 5%							
Differential travel		Sr	< 1...20%					< 1...15%	< 1...20%	
<b>Output characteristics</b>										
Output state indication			Yellow LED							
Switching capacity		mA	2 x 200	200	300	2 x 200	200	300	300	300
Maximum switching frequency		Hz	30	30	15	50	50	15	40	15
Protection against short-circuits			•	•	-(1)	•	•	-(1)	-(1)	-(1)
Voltage drop		V	< 2.5	< 2.5	< 10	< 2.5	< 2.5	< 10	< 2	< 10
Residual current, open state		µA	≤ 100	≤ 100	-	≤ 100	≤ 100	-	< 120	-
Delays	First-up	ms	< 100	< 100	< 200	< 100	< 100	< 200	< 100	< 200
	Response	ms	< 15	< 15	< 30	< 15	< 10	< 30	< 10	< 30
	Recovery	ms	< 15	< 15	< 30	< 15	< 10	< 30	< 10	< 30
<b>Supply</b>										
Rated supply voltage		V	--- 12...24			~ 24...240 50/60 Hz			--- 12...24	
						~ 24...240 50/60 Hz			~ 24...240 50/60 Hz	
Voltage limits (including ripple)		V	--- 10...30			~ 20...265			--- 10...30	
						~ 20...265			~ 20...265	
Current consumption, no-load	24 V	mA	< 25	< 15	-	< 25	< 15	-	-	-
	240 V	mA	-	-	< 4	-	-	< 4	< 3	< 4
Protection against reverse polarity			Yes	Yes	-	Yes	Yes	-	-	-
<b>Environment</b>										
Materials	Case		Plastic							
	Cable		PVC							
	Number and c.s.a. of wires (mm <sup>2</sup> )		-	3 x 0.34	2 x 0.5	-	3 x 0.34	2 x 0.5	2 x 1 (min.) (2) 2 x 2.5 (max.)	2 x 0.5
Degree of protection	Conforming to IEC 60529		IP 67, double insulation ☐					IP 65, double insulation ☐	IP 67, double insulation ☐	
Storage temperature		°C	-10...+60							
Operating temperature		°C	-10...+60							
Vibration resistance	IEC 60068-2-6		10 gn, ± 1 mm (f = 10...55 Hz)							
Shock resistance	IEC 60068-2-27		30 gn, 11 ms							
<b>Resistance to electromagnetic interference</b>										
Electrostatic discharges	IEC 61000-4-2	kV	8 (air) / 4 (contact)							
Radiated electromagnetic fields	IEC 61000-4-3	V/m	3							
Fast transients	IEC 61000-4-4	kV	2							

(1) These sensors do not incorporate overload or short-circuit protection and therefore, it is essential to connect a "quick-blow" fuse in series with the load (see page 12).

(2) The supply cable can have a 14 mm maximum diameter sheath.

**Application example (XT230A2MDB)**

Automatic feed system for livestock

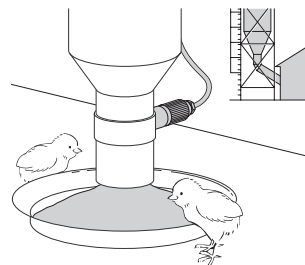

# Capacitive proximity sensors

OsiSense XT

Cylindrical, non flush mountable. Plastic case

AC or DC supply

## Dimensions

### M18, pre-cabled

XT218A1●●L2

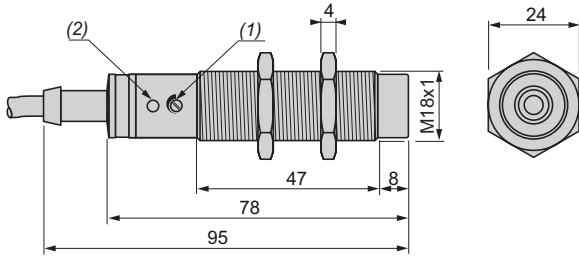

(1) Adjustment potentiometer.  
(2) LED.

### M18, M12 connector

XT218A1PCM12

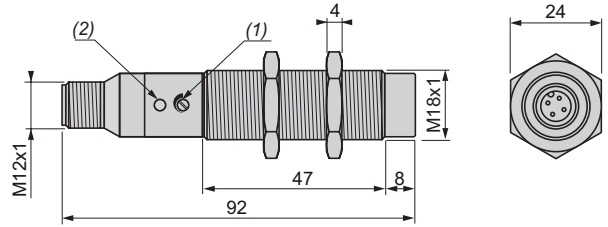

(1) Adjustment potentiometer.  
(2) LED.

### M30, pre-cabled

XT230A1●●L2

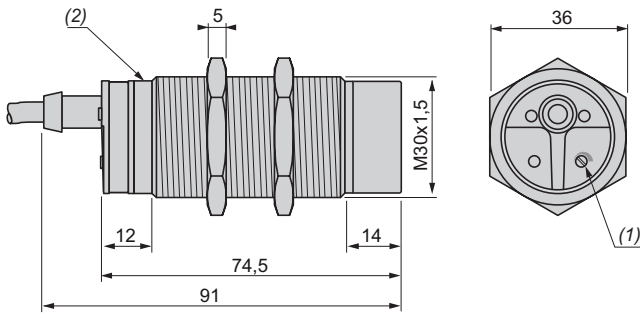

(1) Adjustment potentiometer.  
(2) LED.

### M30, M12 connector

XT230A1PCM12

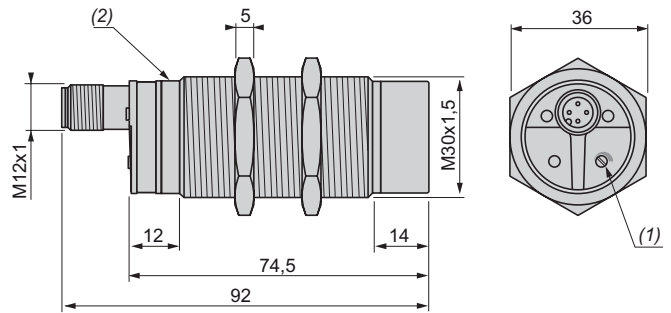

(1) Adjustment potentiometer.  
(2) LED.

### M30, screw terminals

XT230A2MDB

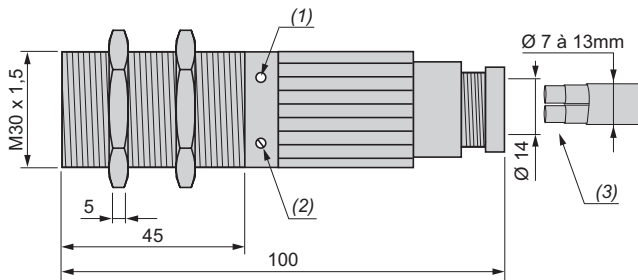

(1) LED.  
(2) Potentiometer.  
(3) 2 x 1 mm<sup>2</sup> to 2.5 mm<sup>2</sup> wires max.

### Ø 32, plain, pre-cabled

XT232A1F●L2

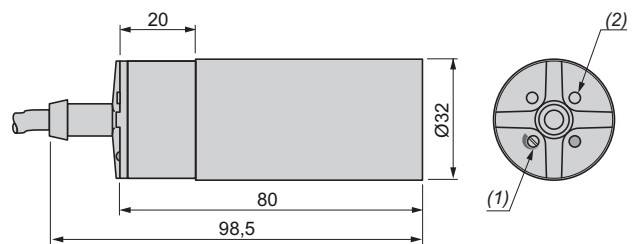

(1) Adjustment potentiometer.  
(2) LED.

## Accessories

### Mounting accessory (included with sensor XT232A1F●L2)

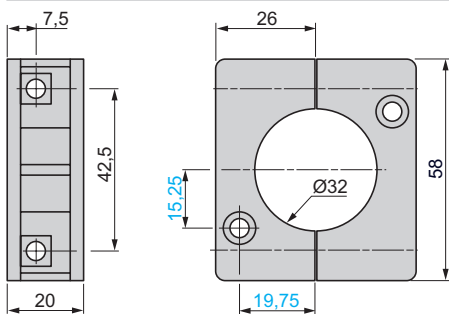

### XXZ12, XXZ30

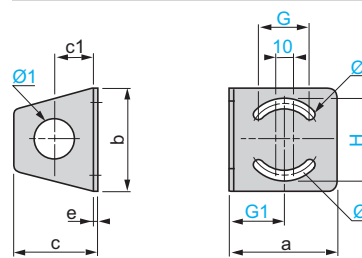

XXZ	a	b	c	c1	e	H	G	G1	Ø	Ø1
12	35	40	33	18	2	31	18	18	25	13
30	67	65	52	25	3	51	35	33	50	31



# Capacitive proximity sensors

OsiSense XT

Cylindrical, non flush mountable. Plastic case

AC or DC supply

## Dimensions (continued)

XUZA118

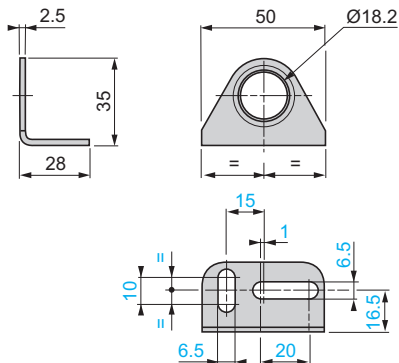

XTAZ30

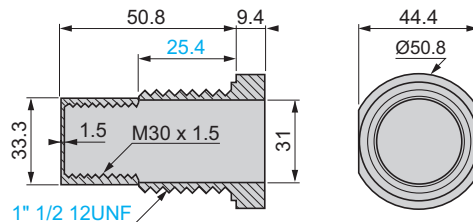

## Wiring schemes

### Connector version

M12 connector

4-wire  $\overline{\sim}$ , PNP  
NO + NC output, M12

XT218/30●●●M12

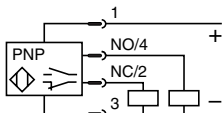

### Screw terminal version

2-wire  $\overline{\sim}$   
NO or NC output, selectable

XT230A2MDB

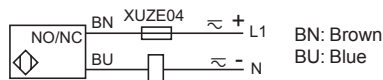

### Pre-cabled version

Cable

3-wire  $\overline{\sim}$ , PNP  
NO output

XT218/30A1PAL2

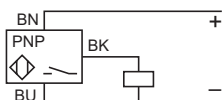

3-wire  $\overline{\sim}$ , NPN  
NO output

XT218/30A1NAL2

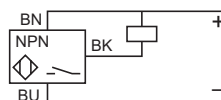

2-wire  $\sim$   
NO output

XT218/30/32A1FAL2

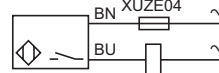

2-wire  $\sim$   
NC output

XT230/32A1FBL2

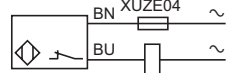

BU: Blue  
BN: Brown  
BK: Black  
WH: White

## Adjustment

### Sensitivity adjustment

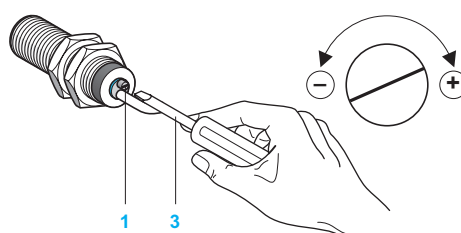
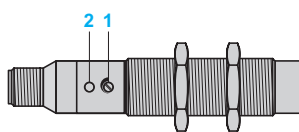

- 1 Adjustment potentiometer LED
- 2 Adjustment using suitable screwdriver (included with sensor)
- 3 Adjustment using suitable screwdriver (included with sensor)

Adjustment from the side for **XT218A1, XT230A2**

Adjustment from the rear for **XT230A1  
XT232A1**

## Setting-up

Minimum mounting distances (mm)

Side by side

Face to face

Facing a metal object

Mounted in support

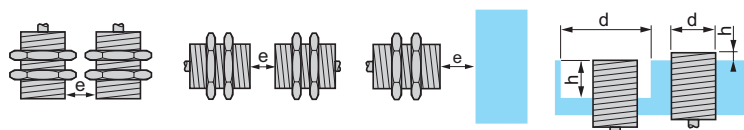

XT218A1, M18 x 1 non flush mountable

$e \geq 40$

$e \geq 6$  Sn

$e \geq 3$  Sn

$d \geq 60$

$h \geq 20$

XT230A1, M30 x 1.5 non flush mountable

$e \geq 60$

$e \geq 6$  Sn

$e \geq 3$  Sn

$d \geq 90$

$h \geq 30$

XT230A2, M30 x 1.5 non flush mountable

$e \geq 16$

$e \geq 90$  Sn

$e \geq 45$  Sn

$d \geq 90$

$h \geq 30$

XT232A1, Ø 32 plain, non flush mountable

$e \geq 65$

$e \geq 6$  Sn

$e \geq 3$  Sn

$d \geq 100$

$h \geq 30$

Fixing nut tightening torque: **XT218A**: 3 N.m, **XT230A**: 8 N.m

Cable gland tightening torque: **XT230A2**: 4 N.m

# Capacitive proximity sensors

OsiSense XT  
For detection of insulated materials  
40 x 40 x 117 format.  
Plastic case, plug-in. Turret head  
AC or DC supply

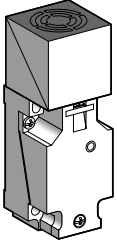

XT7C40●C440

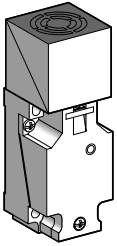

XT7C40●●262

## Sensors flush mountable in support

### 3-wire $\sim$ 12...48 V flush mountable

Sensing distance (Sn) mm	Function	Output	Reference	Weight kg
15	NO + NC	PNP	XT7C40PC440	0.220
		NPN	XT7C40NC440	0.220

### 2-wire $\sim$ 24...240 V (50/60 Hz) flush mountable

Sensing distance (Sn) mm	Function	Reference	Weight kg
15	NO or NC via programming	XT7C40FP262	0.220

## Accessories

### Fuses (for unprotected 2-wire $\sim$ sensors)

Description	Type	Sold in lots of	Unit reference	Weight kg
Cartridge fuses 5 x 20	0.4 A "quick-blow"	10	XUZE04	0.001
	0.63 A "quick-blow"	10	XUZE06	0.001
	0.8 A "quick-blow"	10	XUZE08	0.001

### Fuse terminal block

Description	Sold in lots of	Unit reference	Weight kg
Fuse terminal block for 5 x 20 fuses, grey	50	AB1FUSE435U5X	0.016

## Dimensions

### XT7C40●●●●●

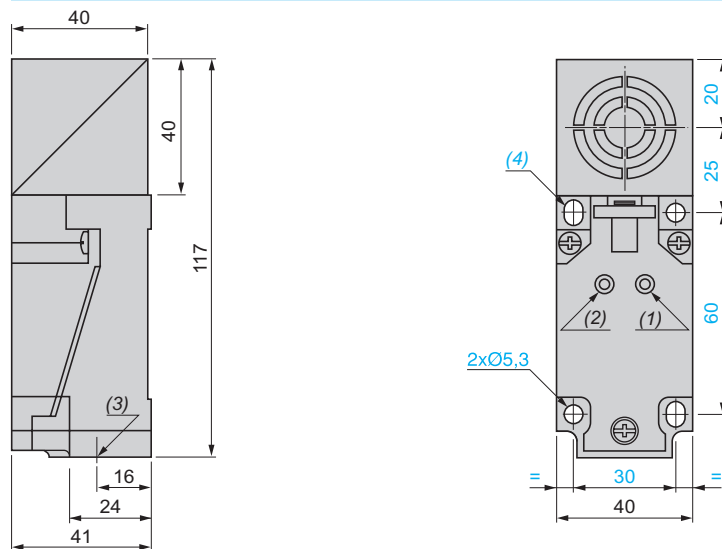

- (1) Output LED
- (2) Supply LED (depending on model)
- (3) 1 tapped entry for 13P cable gland
- (4) 2 elongated holes  $\varnothing$  5.3 x 7

# Capacitive proximity sensors

OsiSense XT  
For detection of insulated materials  
40 x 40 x 117 format.  
Plastic case, plug-in. Turret head  
AC or DC supply

Characteristics			
Sensor type		XT7C40●C440	XT7C40FP262
Connection		Screw terminals, clamping capacity 4 x 1.5 mm <sup>2</sup> (1)	Screw terminals, clamping capacity 3 x 1.5 mm <sup>2</sup> (1)
Degree of protection	Conforming to IEC 60529	IP 67	
Operating zone	mm	0...10.8	
Repeat accuracy		≤ 0.1 Sr	
Product certifications		UL, CSA, CE	
Differential travel		≤ 0.2 Sr	
Operating temperature	°C	- 25...+ 70	
Output state indication		Yellow LED: output Green LED: supply	Yellow LED: output
Rated supply voltage	V	⎓ 12...48	~ 24...240 (50/60 Hz)
Voltage limits (including ripple)	V	⎓ 10...58	~ 20...264
Switching capacity	mA	0...200 with overload and short-circuit protection	5...350 (2 A inrush) (2)
Voltage drop, closed state	V	≤ 2	≤ 5.5
Residual current, open state	mA	–	≤ 1.5
Current consumption, no-load	mA	≤ 10	–
Maximum switching frequency	Hz	100	25
Delays	First-up	ms	≤ 30
	Response	ms	≤ 5
	Recovery	ms	≤ 5

(1) Cable gland not included with sensor. Suitable 13P cable gland: XSZPE13.

(2) These sensors do not incorporate overload or short-circuit protection and therefore, it is essential to connect a "quick-blow" fuse in series with the load (see page 12).

## Wiring schemes

### 3-wire ⎓

NO + NC output

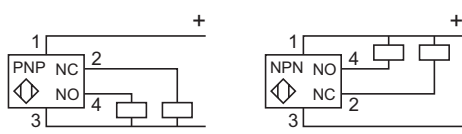

### 2-wire ~ programmable

NO or NC output, depending on position of link

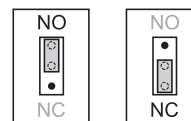
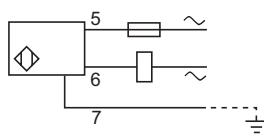

## Setting-up

Minimum mounting distances (mm)

Side by side

Face to face

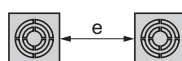

XT7 flush mountable

$e \geq 40$

$e \geq 120$

Flush mounting

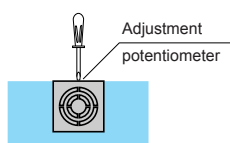

To avoid interference by the immediate surroundings, it may be necessary to reduce the sensitivity when flush mounting the sensor.

A	
AB1FUSE435U5X	12 16
X	
XT7C40FP262	16
XT7C40NC440	16
XT7C40PC440	16
XT112S1NAL2	8
XT112S1PAL2	8
XT112S1PCL2	8
XT112S1PCM12	8
XT118B1FAL2	8
XT118B1FBL2	8
XT118B1NAL2	8
XT118B1PAL2	8
XT118B1PCL2	8
XT118B1PCM12	8
XT130B1FAL2	8
XT130B1FBL2	8
XT130B1NAL2	8
XT130B1PAL2	8
XT130B1PCL2	8
XT130B1PCM12	8
XT132B1FAL2	8
XT132B1FBL2	8
XT218A1FAL2	12
XT218A1NAL2	12
XT218A1PAL2	12
XT218A1PCM12	12
XT230A1FAL2	12
XT230A1FBL2	12
XT230A1NAL2	12
XT230A1PAL2	12
XT230A1PCM12	12
XT232A1FAL2	12
XT232A1FBL2	12
XUZA118	12
XUZE04	12 16
XUZE06	12 16
XUZE08	12 16
XTAZ30	12
XXZ12	12
XXZ30	12



**Schneider Electric Industries SAS**

Head Office  
35, rue Joseph Monier  
F-92500 Rueil-Malmaison  
France

[www.tesensors.com](http://www.tesensors.com)

The information provided in this documentation contains general descriptions and/or technical characteristics of the performance of the products contained herein. This documentation is not intended as a substitute for and is not to be used for determining suitability or reliability of these products for specific user applications. It is the duty of any such user or integrator to perform the appropriate and complete risk analysis, evaluation and testing of the products with respect to the relevant specific application or use thereof. Neither Schneider Electric nor any of its affiliates or subsidiaries shall be responsible or liable for misuse of the information contained herein.

Design: Schneider Electric  
Photos: Schneider Electric