

**Tilt Sensor Switch**

Item No.	RBS330210T	Description	Tilt Sensor Switch	Version	12
Page	1 of 13		Date	Mar. 01, 2018	

● **FUNCTIONS**

1. Tilt Detecting within a 360° radius
2. Vibration Detecting

● **APPLICATIONS**

1. Automatically shut off for home appliances
2. Automatically shut off for Sporting equipment
3. Alarm system
4. Anti-theft / Anti-tamper devices
5. Being motion detection (personal locator)
6. Wake up systems for power saving, such like remote controllers
7. Automatically shut off for motorcycle when tilt
8. Earthquake Detecting



**Tilt Sensor Switch**

Item No.	RBS330210T	Description	Tilt Sensor Switch	Version	12
Page	2 of 13		Date	Mar. 01, 2018	

● **FEATURES**

1. Housing made of high insulation plastic material, free from electric conduction and rust problem.
2. Detecting with photo transistors, generating highly reliable and stable signals.
3. All plastic materials subject to industrial purpose, resist high temperature and meet fireproof function.
4. Simple ON and OFF signals, easy for design.
5. Suitable for horizontal PCB.
6. Tilt Angles: 45° within a 360° radius.
7. RoHS compliance, an ideal substitute for mercury switch.
8. A more economical tilt and vibration detection option than IC design solution.
9. All made in Taiwan and examined before shipment.

● **PATENTS**

1. Taiwan Patent No. I 310952
2. Taiwan Patent No. M 450817
3. Japan Patent No. 4384217
4. Japan Patent No. 3148127
5. U.S.A. Patent No. US 6,800,841 B1
6. U.S.A. Patent No. US 7,402,791 B2
7. China Patent No. ZL 200610083013.5
8. China Patent No. ZL 200820126206.9
9. China Patent No. ZL 201220539712.7



**Tilt Sensor Switch**

Item No.	RBS330210T	Description	Tilt Sensor Switch	Version	12
Page	3 of 13		Date	Mar. 01, 2018	

● DIMENSIONS / OPERATION / P.C.B. LAYOUT (Unit: mm, Tolerance: ±0.25mm)

Fig. 1

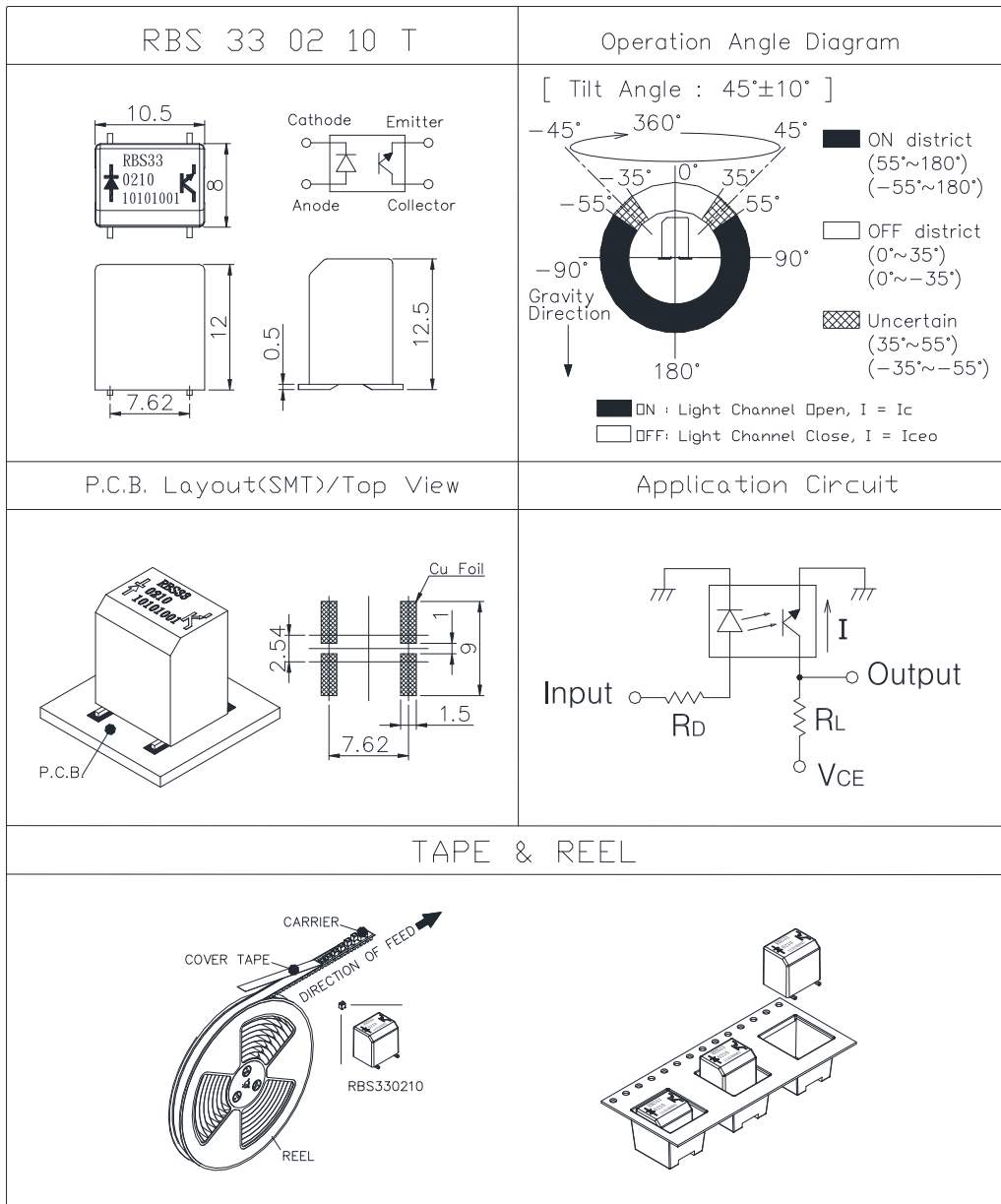

**Tilt Sensor Switch**

Item No.	RBS330210T	Description	Tilt Sensor Switch	Version	12
Page	4 of 13		Date	Mar. 01, 2018	

● Current/Voltage Suggested

Input Current (mA)	Operating Voltage (V)	Condition
10	3.3	V <sub>CE</sub> =3.3V R <sub>D</sub> =200 ohm R <sub>L</sub> =33K ohm
10	5	V <sub>CE</sub> =5V R <sub>D</sub> =390 ohm R <sub>L</sub> =33K ohm

● Absolute Maximum Rating ( Ta=25°C )

Item		Symbol	Rating	Unit
Input	Power Dissipation	P <sub>d</sub>	75	mW
	Reverse Voltage	V <sub>R</sub>	5	V
	Forward Current	I <sub>F</sub>	50	mA
	Peak Forward Current (*1)	I <sub>FP</sub>	1	A
Output	Collector Power Dissipation	P <sub>C</sub>	100	mW
	Collector Current	I <sub>C</sub>	20	mA
	C-E Voltage	V <sub>CEO</sub>	30	V
	E-C Voltage	V <sub>ECO</sub>	5	V
Operating Temperature		T <sub>opr</sub>	-25~+85	°C
Storage Temperature		T <sub>stg</sub>	-40~+85	°C
Soldering Temperature (*2)		T <sub>sol</sub>	260	°C

(\*1) t<sub>w</sub>=100 uSec. 、 T=10 mSec.

(\*2) t=5 Sec



Tilt Sensor Switch

Item No.	RBS330210T	Description	Tilt Sensor Switch	Version	12
Page	5 of 13		Date	Mar. 01, 2018	

● Electrical Optical Characteristics (Ta=25°C)

Parameter	Symbol	Condition	Min.	Typ.	Max.	Unit
Forward Voltage	V <sub>F</sub>	I <sub>F</sub> =20mA	-	1.2	1.5	V
Reverse Current	I <sub>R</sub>	V <sub>R</sub> =5V	-	-	10	μA
Peak Wavelength	λ <sub>p</sub>	I <sub>F</sub> =10mA		940		nm
Dark Current	I <sub>ceo</sub>	V <sub>CE</sub> =10V	-	-	2	μA
C-E Saturation Voltage	V <sub>CE (sat)</sub>	I <sub>C</sub> =0.25mA I <sub>F</sub> =20mA	-	-	0.4	V
Light Current	I <sub>c</sub>	V <sub>CE</sub> =5V I <sub>F</sub> =20mA	0.5	5	-	mA
Rise Time	T <sub>r</sub>	I <sub>C</sub> =0.8mA V <sub>CC</sub> =30V	-	5	-	μsec
Fall Time	T <sub>f</sub>	R <sub>L</sub> =1KΩ	-	5	-	μsec



**Tilt Sensor Switch**

Item No.	RBS330210T	Description	Tilt Sensor Switch	Version	12
Page	6 of 13		Date	Mar. 01, 2018	

● Typical Electrical / Optical Characteristics Curves (Ta=25°C)

Fig.1 Power Dissipation vs. Ambient Temperature

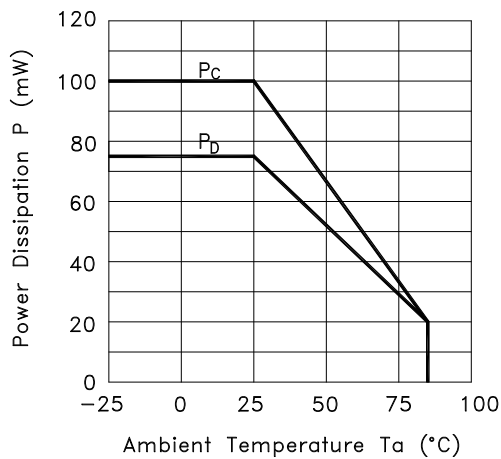

Fig.2 Forward Current vs. Forward Voltage

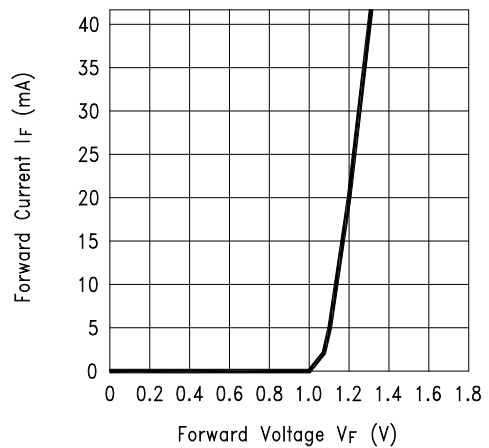

Fig.3 Collector Current vs. Collector-emitter Voltage

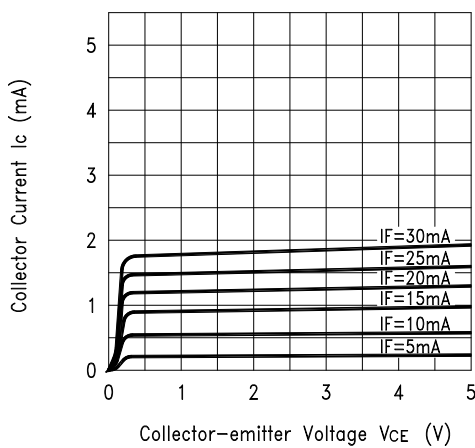
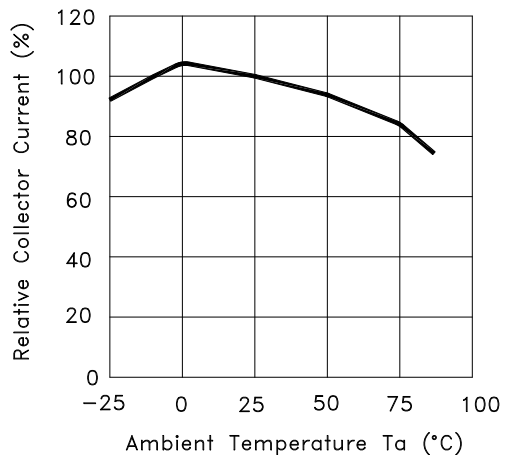

Fig.4 Collector Current vs. Ambient Temperature



Tilt Sensor Switch

Item No.	RBS330210T	Description	Tilt Sensor Switch	Version	12
Page	7 of 13		Date	Mar. 01, 2018	

Fig.5 Collector-emitter Saturation Voltage vs. Ambient Temperature

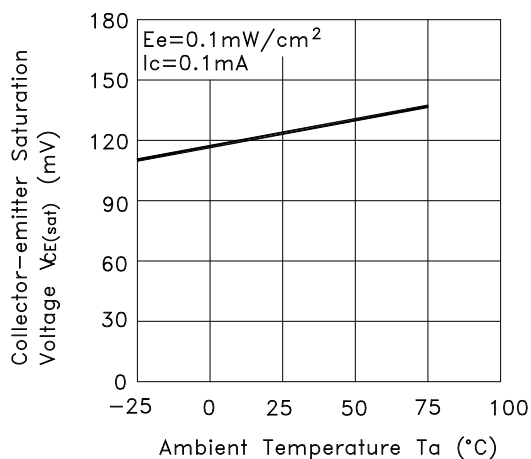

**Tilt Sensor Switch**

Item No.	RBS330210T	Description	Tilt Sensor Switch	Version	12
Page	8 of 13		Date	Mar. 01, 2018	

● **RELIABLE TEST ITEMS**

Test Item	Standard	Contents
IR Reflow	MIL-STD-202H, TEST METHOD 210F, IPC/JEDEC J-STD-020D	Peak temp.=255~260°C *3times
Operating Temperature	MIL-STD-202H, TEST METHOD 107G, TEST A	-25°C~85°C
Storage Temperature	MIL-STD-202H, TEST METHOD 107G, TEST A	-40°C ~85°C
Humidity	MIL-STD-202H, TEST METHOD 103B	40°C /95%RH
Mechanical Life	--	2Hz, horizontal 1,000,000 times
Electrical Life	MIL-STD-883E:1016	I <sub>F</sub> =20 mA, V <sub>CE</sub> =5 V TIME: 30,000 hrs





**Tilt Sensor Switch**

Item No.	RBS330210T	Description	Tilt Sensor Switch	Version	12
Page	9 of 13		Date	Mar. 01, 2018	

● **SOLDERING CONDITION**

Following soldering conditions are for reference only, please use soldering information that solder paste manufacturer recommends.

Condition Operation Method	Soldering Temperature	Soldering Time	Wattage of Manual Soldering	Suitable Production Process
IR Reflow	Please refer to following < Table of classification Reflow profile > and Fig. 2		-	SMT
Manual Soldering	300±5°C	< 3 seconds max.	30W or Temperature-controlled manual soldering	SMT



**Tilt Sensor Switch**

Item No.	RBS330210T	Description	Tilt Sensor Switch	Version	12
Page	10 of 13		Date	Mar. 01, 2018	

< Table of classification Reflow profile >

Item	Pb process	Pb free process
Pre-heat and Soak Temperature min.(T <sub>min</sub> ) Temperature max.(T <sub>max</sub> ) Time (T <sub>min</sub> to T <sub>max</sub> )(t <sub>s</sub> )	100 °C 150 °C 60-120 seconds	150 °C 200 °C 60-120 seconds
Average ram-up Rate (T <sub>max</sub> to T <sub>p</sub> )	3 °C/second max.	3 °C/second max.
Liquidous Temperature (TL) Time at Liquidous (tL)	183 °C 60-150 seconds	217 °C 60-150 seconds
Peak package body Temperature (T <sub>p</sub> )*	230 °C ~235 °C *	255 °C ~260 °C *
Classification temperature(T <sub>c</sub> )	235 °C	260 °C
Time(t <sub>p</sub> )** within 5 °C of the specified classification temperature (T <sub>c</sub> )	20** seconds	30** seconds
Average ram-down Rate (T <sub>p</sub> to T <sub>max</sub> )	6 °C/second max.	6 °C/second max.
Time 25 °C to peak temperature	6 minutes max.	8 minutes max.
* Tolerance for peak profile temperature (T <sub>p</sub> ) is defined as a supplier minimum and a user maximum. ** Tolerance for time at peak profile temperature (t <sub>p</sub> ) is defined as a supplier minimum and a user maximum.		



Tilt Sensor Switch

Item No.	RBS330210T	Description	Tilt Sensor Switch	Version	12
Page	11 of 13		Date	Mar. 01, 2018	

Fig. 2

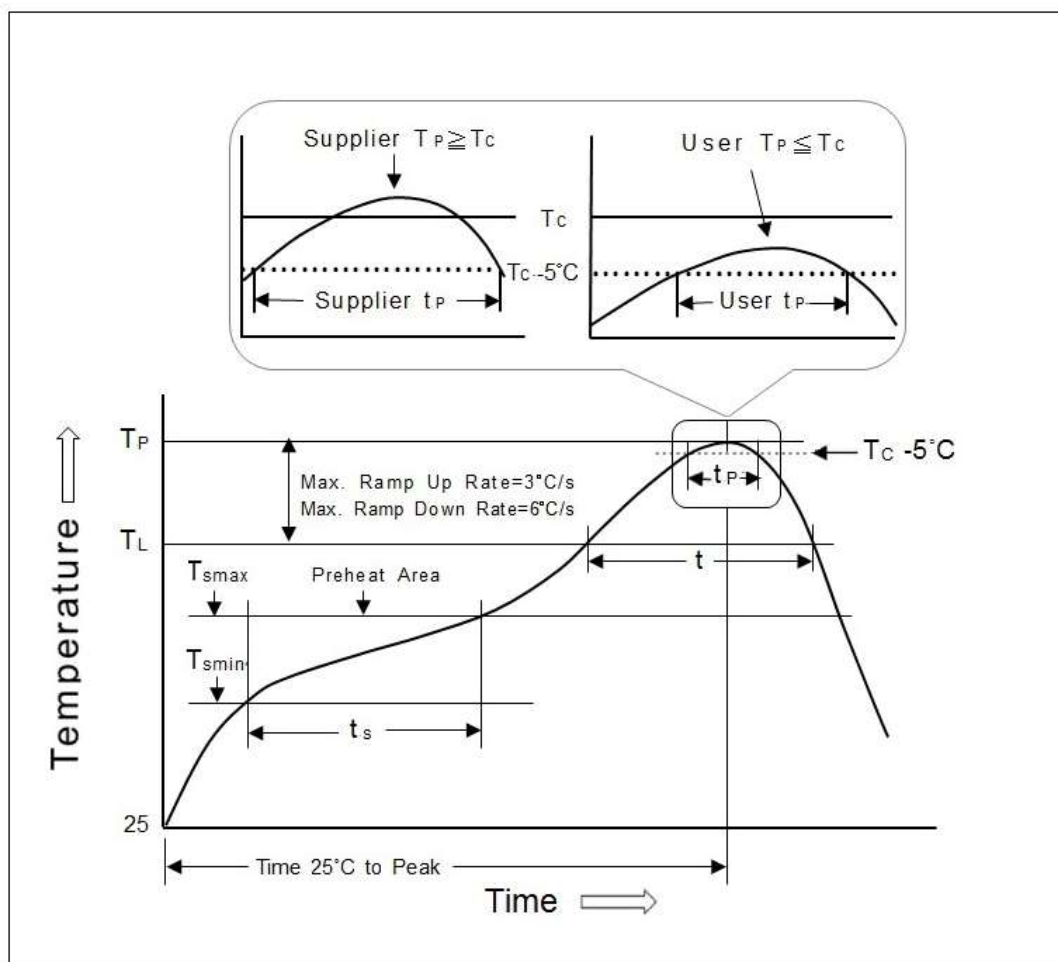

**Tilt Sensor Switch**

Item No.	RBS330210T	Description	Tilt Sensor Switch	Version	12
Page	12 of 13		Date	Mar. 01, 2018	

● PACKAGE

	Part Number	Package	Quantity	Total Q'ty	Dimension(mm)
1.	RBS330210T	Tape & Reel	250 pcs	250 pcs	φ330*25H
		Inner Box	2 Reels	500 pcs	355L*340W*68H
		Carton	10 Boxes	5,000 pcs	703L*364W*380H

※ Package is shown as below for reference.

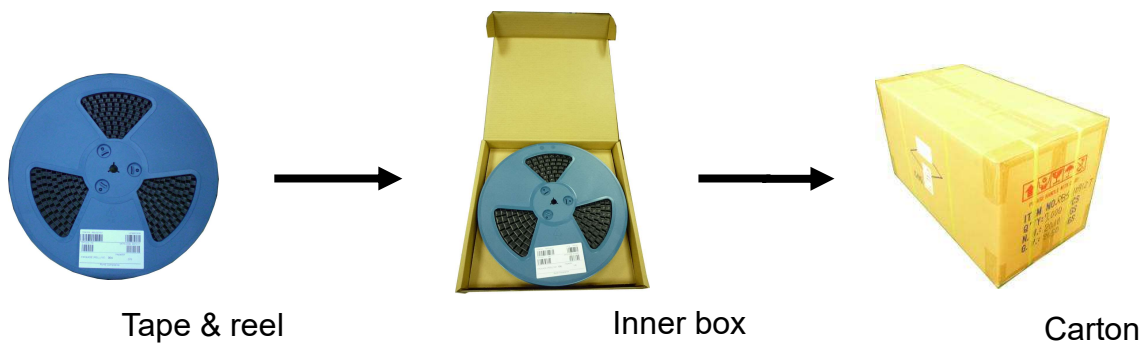

**Tilt Sensor Switch**

Item No.	RBS330210T	Description	Tilt Sensor Switch	Version	12
Page	13 of 13		Date	Mar. 01, 2018	

● NOTE

1. Suggestion for usage: For vibration usage or application, we suggest to add hysteresis for IC.
2. For the continued product improvement as one of the company policy, specifications may change or update without notice. The latest information can be obtained through our sales offices. Normally, all products are supplied under our standard conditions.

● PRECAUTIONS FOR USE

1. If the products is intended to be used for other endurance equipment requiring higher safety and reliability such as life support system, space and aviation devices, disaster and safety system, it's necessary to make verification of conformity or contact us for the details before using.
2. Do not try to clean the switch with a solvent or similar substance after the soldering process.
3. Use water-soluble flux may damage the switch.
4. When the soldering temperature exceeds specifications, the switch may fall apart.
5. Do not use switch in the environment of high humidity, because such an environment may cause the leakage current between the terminals.
6. Please do not exceed the rated load as there will be a risk of disabling the product function.
7. In the circuit, switch should not be near or directly connected with the magnetic component solder joints (for example: relays, transformers, etc.).
8. To prevent damaging IR and PT, please make electrostatic protective treatment, for example: wearing a conductive wrist strap or antistatic gloves during production process, and grounding machinery etc.

