

# SIMATIC PXI inductive proximity switches

## SIMATIC PXI300

### Overview

#### SIMATIC sensors PXI300

Sensors for applications with special requirements:

- Increased operating voltages
- Higher degrees of protection
- Operating distances better than specified in standard

### Selection table

SIMATIC PXI300								
Type, Ø	4 mm	M5	M8	M12	Box with M14	6.5 mm	8 mm x 8 mm	M18
<b>Operating distance</b>								
• 0 ... 0.8 mm (PXI.1.)	0.6 mm	0.6 mm						
• 1 ... 4 mm (PXI.2.)			1 mm 2 mm 2.5 mm 3 mm	2 mm 4 mm	2.5 mm	2.5 mm 3 mm	3 mm	
• 5 ... 10 mm (PXI.3.)			6 mm	6 mm 10 mm	5 mm			5 mm 8 mm
• 12 ... 22 mm (PXI.4.)								12 mm 20 mm
<b>Output</b>								
• NO contact/NC contact	■ / —	■ / —	■ / ■	■ / ■	■ / ■	■ / —	■ / —	■ / ■
• pnp/npn	■ / —	■ / —	■ / ■	■ / ■	■ / —	■ / —	■ / ■	■ / ■
<b>Number of wires</b>	3	3	3	2, 3	2, 3	3	3	2, 3
<b>Operating voltage</b>								
• 10/15 ... 30/35 V DC	■	■	■	■		■	■	■
• 10 ... 65 V DC			■	■	■			■
• 20 ... 265/320 V AC/DC				■	■			■
<b>Connection</b>								
• M8 connector			■			■	■	
• M12 connector			■	■	■			■
• Cable	■	■	■	■	■	■	■	■
<b>Degree of protection</b>								
• IP65 / IP67			— / ■	— / ■	— / ■	— / ■	— / ■	— / ■
• IP68 / IP69K	■ / —	■ / —	■ / —	■ / ■		■ / —		■ / ■
<b>See page</b>	2/172	2/172	from 2/172	from 2/173	2/176, 2/184	from 2/178	2/179	from 2/185

A configurator for fast product selection and ordering in the Internet can be found at [www.siemens.com/simatic-sensors/px](http://www.siemens.com/simatic-sensors/px)

# SIMATIC PXI inductive proximity switches

## SIMATIC PXI300

### SIMATIC PXI300



Type, Ø	18 mm	M30	40 mm x 40 mm	60 mm x 80 mm	80 mm x 100 mm
<b>Operating distance</b>					
• 5 ... 10 mm (PXI33.)	5 mm 8 mm	10 mm			
• 12 ... 22 mm (PXI34.)		15 mm 22 mm	15 mm 20 mm		
• 25 ... 40 mm (PXI35.)		40 mm	25 mm 30 mm 35 mm 40 mm	30 mm	30 mm 40 mm
• 50 ... 75 mm (PXI36.)				50 mm	65 mm
<b>Output</b>					
• NO contact/NC contact	■ / ■	■ / ■	■ / ■	■ / ■	■ / ■
• pnp/npn	■ / ■	■ / ■	■ / ■	■ / —	■ / —
<b>Number of wires</b>	3	2, 3	2, 3, 4	2, 3	2, 3
<b>Operating voltage</b>					
• 10/15 ... 30/35 V DC	■	■	■		
• 10 ... 65 V DC		■	■	■	■
• 20 ... 265/320 V AC/DC		■	■	■	■
<b>Connection</b>					
• M12 connector		■	■		
• Cable	■	■	■		
• Terminal compartment			■	■	■
<b>Degree of protection</b>					
• IP65 / IP67		— / ■	■ / ■	■ / —	■ / —
• IP68 / IP69K	■ / ■	■ / ■	■ / ■		
<b>See page</b>	from 2/186	from 2/192	from 2/197	from 2/207	from 2/211

A configurator for fast product selection and ordering in the Internet can be found at [www.siemens.com/simatic-sensors/px](http://www.siemens.com/simatic-sensors/px)

# SIMATIC PXI inductive proximity switches

## SIMATIC PXI300

Operating distance 0.6 mm  
Operating distance 1 mm

### Technical specifications

Class	IP68	IP68	Extra duty (65 V DC)
Number of wires	3-wire	3-wire	3-wire
Design	Ø 4 mm, mini	M5, mini	M8
Installation in metal	Flush	Flush	Flush
Rated operating distance $s_n$	0.6 mm	0.6 mm	1 mm
Enclosure material	Stainless steel	Stainless steel	Stainless steel
Operational voltage (DC) V	10 ... 30	10 ... 30	10 ... 65
No-load supply current $I_0$ mA	≤ 10	≤ 10	≤ 10
Rated operational current $I_e$ mA	200	200	200
Switching frequency $f$ Hz	3000	3000	5000
Repeat accuracy $R$ mm	0.01	0.01	0.1
Power-up delay $t_v$ ms	8	8	40
Switching status display	–	–	Yellow LED
Precautions			
• Spurious signal suppression	•	•	•
• Short-circuit-proof/overload-proof	•	•	•
• Reverse-polarity protection	•	•	•
• Wire-break protection	–	–	•
• Inductive interference protection	•	•	•
• Radio interference protection	•	•	•
Degree of protection	IP68	IP68	IP67

### Selection and Ordering data

Switching output	Circuit diagram number <sup>1)</sup>	Connector type <sup>2)</sup>	Order No.	Order No.	Order No.
<b>With 2 m cable, PUR</b>					
NO contact, pnp	11	▶	3 × 0.14 mm <sup>2</sup> <b>3RG46 00-0AG02</b>	▶	3 × 0.14 mm <sup>2</sup> <b>3RG46 10-0AG02</b>
NC contact, pnp	12	▶	–	▶	<b>3RG40 11-0AB00</b> <b>3RG40 11-0AA00</b>
<b>With 8 mm combination plug</b>					
NO contact, pnp	2	A	–	▶	<b>3RG40 11-7AB00</b>
NC contact, pnp	3	A	–	▶	<b>3RG40 11-7AA00</b>
<b>With M12 connector</b>					
NO contact, pnp	2	E, F	–	▶	<b>3RG40 11-3AB00</b>
NC contact, pnp	3	F	–	▶	<b>3RG40 11-3AA00</b>

1) See page 2/242.

2) See from page 2/268.

▶ Preferred type, available from stock.

### Dimensions

#### Mounting instructions

Dimension depending on form

A = active surface

B = metal-free area

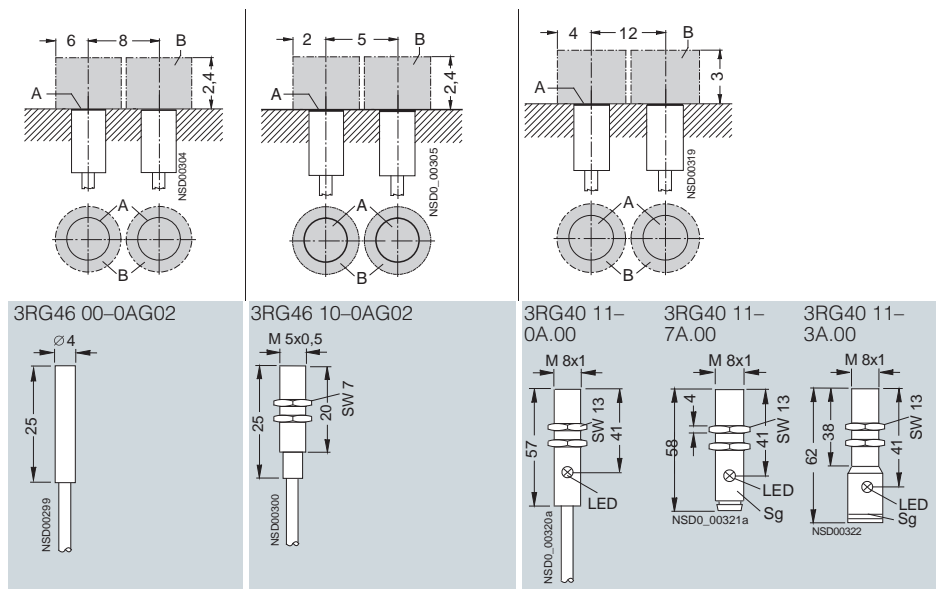

### Technical specification

Class		Extra duty (65 V DC)	Extra duty (AC/DC)
Number of wires		3-wire	2-wire
Design		M12	M12
Installation in metal		Flush	Flush
Rated operating distance $s_n$		2 mm	2 mm
Enclosure material		Brass, nickel-plated	Brass, nickel-plated
Operating voltage			
• DC	V	10 ... 65	20 ... 320
• AC	V	–	20 ... 265
No-load supply current $I_0$			
• At 24 V DC	mA	≤ 10	1.0
• At 230 V AC	mA	–	1.5
Rated operational current $I_e$			
• Continuous	mA	300	200
• 20 ms	mA	–	1800
Minimum load current	mA	–	5
Switching frequency $f$	Hz	4000	25/1200 (AC/DC)
Repeat accuracy $R$	mm	0.1	0.04
Power-up delay $t_v$	ms	40	100
Switching status display		Yellow LED	Yellow LED
Precautions			
• Spurious signal suppression	•	•	•
• Short-circuit-proof/overload-proof	•	–	–
• Reverse-polarity protection	•	•	•
• Wire-break protection	•	•	•
• Inductive interference protection	•	•	•
• Radio interference protection	•	•	•
Degree of protection		IP67	IP67

### Selection and Ordering data

Switching output	Circuit diagram number <sup>1)</sup>	Connector type <sup>2)</sup>	Order No.	Order No.
<b>With 2 m cable, PUR</b>				
NO contact, pnp	11	▶ B	3RG40 12-0AB00	–
NC contact, pnp	12	▶	3RG40 12-0AA00	–
NO contact	16	–	–	▶ B 3RG40 12-0KB00
NC contact	17	–	–	B 3RG40 12-0KA00
<b>With M12 connector</b>				
NO contact, pnp	2	E, F	▶ B 3RG40 12-3AB00	–
NC contact, pnp	3	F	3RG40 12-3AA00	–
NO contact	8	E, F	–	▶ B 3RG40 12-3KB00
NC contact	9	F	–	B 3RG40 12-3KA00

1) See page 2/242.

2) See from page 2/268.

▶ Preferred type, available from stock.

B: Subject to export regulations AL = N and ECCN = EAR99.

### Dimensions

#### Mounting instructions

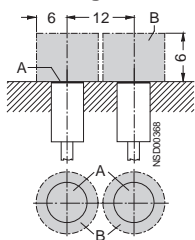

A = active surface  
B = metal-free area

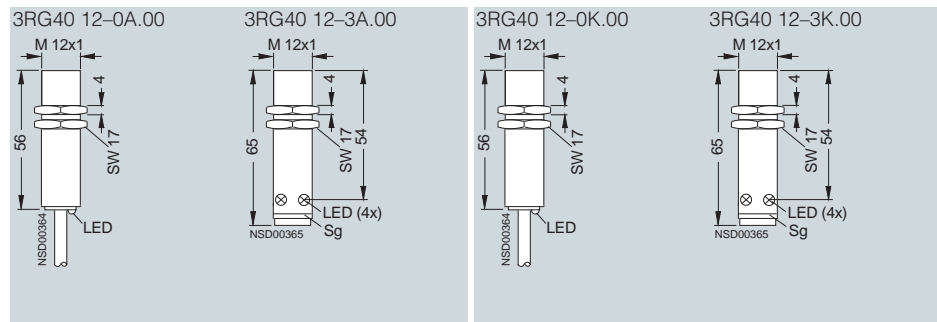

# SIMATIC PXI inductive proximity switches

## SIMATIC PXI300

Operating distance 2 mm

### Technical specifications

Class	IP68 / 69 K	IP68 / 69 K	IP68 / 69 K
Number of wires	3-wire	3-wire	3-wire
Design	Ø 12 mm	M12	M12
Installation in metal	Flush	Flush	Flush
Rated operating distance $s_n$	2 mm	2 mm	2 mm
Enclosure material	Molded plastic	Molded plastic	Brass, nickel-plated
Operating voltage (DC)	V 15 ... 34	15 ... 34	15 ... 34
No-load supply current $I_0$	mA ≤ 17 (24 V); ≤ 30 (34 V)	≤ 17 (24 V); ≤ 30 (34 V)	≤ 17 (24 V); ≤ 30 (34 V)
Rated operational current $I_e$	mA 200 (≤ 50 °C); 150 (≤ 85 °C)	200 (≤ 50 °C); 150 (≤ 85 °C)	200 (≤ 50 °C); 150 (≤ 85 °C)
Switching frequency $f$	Hz 1200	1200	1200
Repeat accuracy $R$	mm 0.1	0.1	0.1
Power-up delay $t_v$	ms 40	40	40
Switching status display	Yellow LED	Yellow LED	Yellow LED
Precautions	<ul style="list-style-type: none"> <li>• Spurious signal suppression</li> <li>• Short-circuit-proof/overload-proof</li> <li>• Reverse-polarity protection</li> <li>• Wire-break protection</li> <li>• Inductive interference protection</li> <li>• Radio interference protection</li> </ul>	<ul style="list-style-type: none"> <li>•</li> <li>•</li> <li>•</li> <li>•</li> <li>•</li> <li>•</li> </ul>	<ul style="list-style-type: none"> <li>•</li> <li>•</li> <li>•</li> <li>•</li> <li>•</li> <li>•</li> </ul>
Degree of protection	IP68 / 69 K	IP68 / 69 K	IP68 / 69 K

### Selection and Ordering data

Switching output	Circuit diagram number <sup>1)</sup>	Connector type <sup>2)</sup>	Order No.	Order No.	Order No.
<b>With M12 connector</b>					
NO contact, pnp	2	E, F	–	–	B <b>3RG40 12-3AG31</b>
<b>With 2 m cable</b>					
			PUR, 3 × 0.25 mm <sup>2</sup>	PUR, 3 × 0.25 mm <sup>2</sup>	PVC, 3 × 0.25 mm <sup>2</sup>
NO contact, pnp	11		B <b>3RG40 52-0AG30</b>	B <b>3RG40 12-0AG30</b>	B <b>3RG40 12-0AG31</b>
NC contact, pnp	12		B <b>3RG40 52-0AF30</b>	B <b>3RG40 12-0AF30</b>	–
NO contact, npn	13		B <b>3RG40 52-0GB30</b>	B <b>3RG40 12-0GB30</b>	B <b>3RG40 12-0GB31</b>
NC contact, npn	14		B <b>3RG40 52-0GA30</b>	B <b>3RG40 12-0GA30</b>	–

1) See page 2/242.

2) See from page 2/268.

B: Subject to export regulations AL = N and ECCN = EAR99.

### Dimensions

#### Mounting instructions

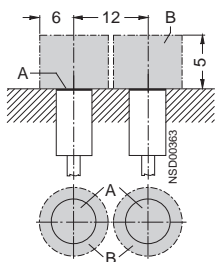

A = active surface  
B = metal-free area

3RG40 52-0..30

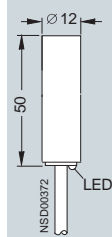

3RG40 12-0..30

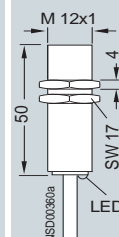

3RG40 12-0..31

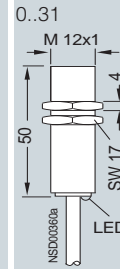

3RG40 12-3..31

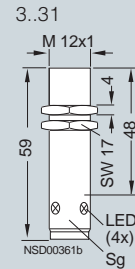

# SIMATIC PXI inductive proximity switches

## SIMATIC PXI300

Operating distance 2 mm

2

### Technical specifications

Class	Greater rated operating distance	
Number of wires	3-wire	3-wire
Design	M8, Shorty	M8
Installation in metal	Flush	Flush
Rated operating distance $s_n$	2 mm	2 mm
Enclosure material	Stainless steel	Stainless steel
Operating voltage (DC)	V 15 ... 34	10 ... 34
No-load supply current $I_0$	mA $\leq 17$ (24 V); $\leq 30$ (34 V)	$\leq 17$ (24 V); $\leq 30$ (34 V)
Rated operational current $I_e$	mA 200 ( $\leq 50$ °C); 150 ( $\leq 85$ °C)	200 ( $\leq 50$ °C); 150 ( $\leq 85$ °C)
Switching frequency $f$	Hz 600	600
Repeat accuracy $R$	mm 0.1	0.1
Power-up delay $t_v$	ms 40	40
Switching status display	Yellow LED	Yellow LED
Precautions	<ul style="list-style-type: none"> <li>• Spurious signal suppression</li> <li>• Short-circuit-proof/overload-proof</li> <li>• Reverse-polarity protection</li> <li>• Wire-break protection</li> <li>• Inductive interference protection</li> <li>• Radio interference protection</li> </ul>	<ul style="list-style-type: none"> <li>•</li> <li>•</li> <li>•</li> <li>•</li> <li>•</li> <li>•</li> </ul>
Degree of protection	IP67	IP67

### Selection and Ordering data

Switching output	Circuit diagram number <sup>1)</sup>	Connector type <sup>2)</sup>	Order No.	Order No.
<b>With 2 m cable, PUR</b>			3 × 0.25 mm <sup>2</sup>	3 m, 3 × 0.25 mm <sup>2</sup>
NO contact, pnp	11	▶ B	<b>3RG41 11-0AG33</b>	▶ <b>3RG41 11-0AG00</b>
NC contact, pnp	12	B	<b>3RG41 11-0AF33</b>	–
NO contact, npn	13		<b>3RG41 11-0GB33</b>	–
NC contact, npn	14		<b>3RG41 11-0GA33</b>	–
<b>With 8 mm combination plug</b>				
NO contact, pnp	2	A	B <b>3RG41 11-7AG33</b>	–
NC contact, pnp	3	A	▶ B <b>3RG41 11-7AF33</b>	–
NO contact, npn	4	A	B <b>3RG41 11-7GB33</b>	–
NC contact, npn	5	A	B <b>3RG41 11-7GA33</b>	–
<b>With M12 connector</b>				
NO contact, pnp	2	E, F	–	▶ <b>3RG41 11-3AG00</b>
NO contact, npn	2	E, F	–	

1) See page 2/242.  
 2) See from page 2/268.  
 ▶ Preferred type, available from stock.  
 B: Subject to export regulations AL = N and ECCN = EAR99.

### Dimensions

#### Mounting instructions

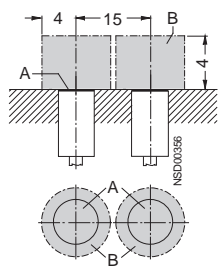

A = active surface  
 B = metal-free area

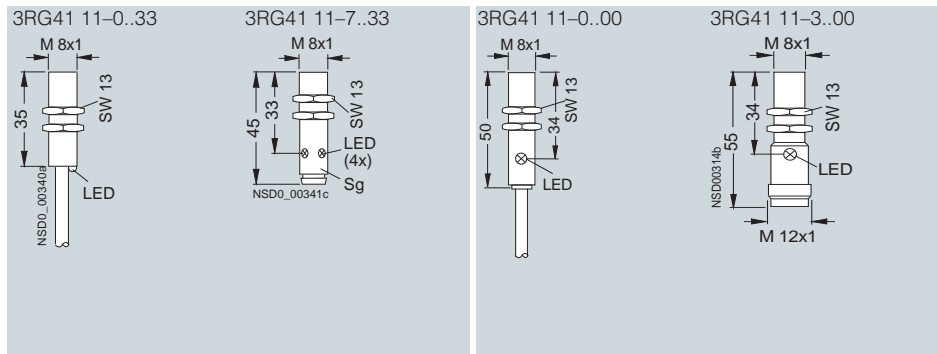

# SIMATIC PXI inductive proximity switches

## SIMATIC PXI300

Operating distance 2.5 mm

### Technical specifications

Class		Extra duty (65 V DC)	Extra duty (AC/DC)
Number of wires		3-wire	2-wire
Design		M14	M14
Installation in metal		Flush	Flush
Rated operating distance $s_n$		2.5 mm	2.5 mm
Enclosure material		Molded plastic	Molded plastic
Operating voltage			
• DC	V	10 ... 65	20 ... 320
• AC	V	–	20 ... 265
No-load supply current $I_0$			
• At 24 V DC	mA	≤ 10	1.0
• At 230 V AC	mA	–	1.5
Rated operational current $I_e$			
• Continuous	mA	300	200
• 20 ms	mA	–	1200
Minimum load current	mA	–	5
Switching frequency $f$	Hz	800	25/1000 (AC/DC)
Repeat accuracy $R$	mm	0.05	0.04
Power-up delay $t_v$	ms	40	100
Switching status display		Yellow LED	Yellow LED
Precautions			
• Spurious signal suppression	•	•	•
• Short-circuit-proof/overload-proof	•	–	–
• Reverse-polarity protection	•	•	•
• Wire-break protection	•	•	•
• Inductive interference protection	•	•	•
• Radio interference protection	•	•	•
Degree of protection		IP67	IP67

### Selection and Ordering data

Switching output	Circuit diagram number <sup>1)</sup>	Connector type <sup>2)</sup>	Order No.	Order No.
<b>With 2 m cable, PUR</b>			$3 \times 0.25 \text{ mm}^2$	$2 \times 0.25 \text{ mm}^2$
NO contact, pnp	11	▶ B	<b>3RG40 72-0AB00</b>	–
NC contact, pnp	12	B	<b>3RG40 72-0AA00</b>	–
NO contact	16	–	–	B <b>3RG40 72-0KB00</b>
NC contact	17	–	–	B <b>3RG40 72-0KA00</b>
<b>With M12 connector</b>				
NO contact, pnp	2	E, F	▶ B <b>3RG40 72-3AB00</b>	–
NO contact	8	E, F	–	B <b>3RG40 72-3KB00</b>
NC contact	9	F	–	B <b>3RG40 72-3KA00</b>

1) See page 2/242.

2) See from page 2/268.

▶ Preferred type, available from stock.

B: Subject to export regulations AL = N and ECCN = EAR99.

### Dimensions

#### Mounting instructions

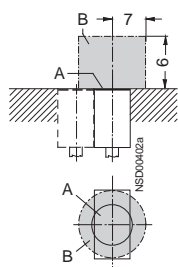

A = active surface  
B = metal-free area

These proximity switches can be mounted next to one another.

3RG40 72-3..00

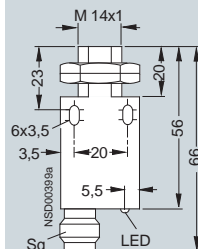

Plan view

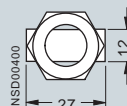

3RG40 72-0..00

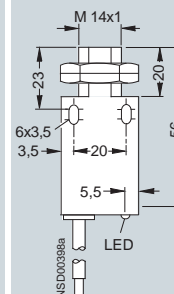

### Technical specifications

Class	Increased operating distance (IP68)	
Number of wires	3-wire	3-wire
Design	Ø 6.5 mm	M8
Installation in metal	Flush	Flush
Rated operating distance $s_n$	2.5 mm	2.5 mm
Enclosure material	Stainless steel	Stainless steel
Operational voltage (DC)	V 10 ... 30	10 ... 30
No-load supply current $I_0$	mA ≤ 10	≤ 10
Rated operational current $I_e$	mA 200	200
Switching frequency $f$	Hz 1000	1000
Repeat accuracy $R$	mm 0.15	0.15
Power-up delay $t_v$	ms 50	50
Switching status display	–	–
Precautions	<ul style="list-style-type: none"> <li>• Spurious signal suppression</li> <li>• Short-circuit-proof/overload-proof</li> <li>• Reverse-polarity protection</li> <li>• Wire-break protection</li> <li>• Inductive interference protection</li> <li>• Radio interference protection</li> </ul>	<ul style="list-style-type: none"> <li>•</li> <li>•</li> <li>•</li> <li>•</li> <li>•</li> <li>•</li> </ul>
Degree of protection	IP68	IP68

### Selection and Ordering data

Switching output	Circuit diagram number <sup>1)</sup>	Order No.	Order No.
<b>With 2 m cable, PUR</b>		$3 \times 0.14 \text{ mm}^2$	$3 \times 0.14 \text{ mm}^2$
NO contact, pnp	11	▶ <b>3RG46 02-0AG02</b>	▶ <b>3RG46 11-0AG02</b>

1) See page 2/242.

▶ Preferred type, available from stock.

### Dimensions

#### Mounting instructions

A = active surface

B = metal-free area

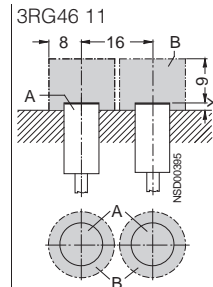
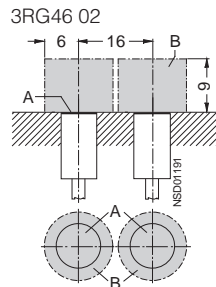
 $X \geq 1.6 \text{ mm}$  when mounted in steel, $X \geq 0.8 \text{ mm}$  when mounted in other metal

3RG46 02-0AG02

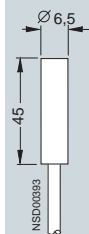

3RG46 11-0AG02

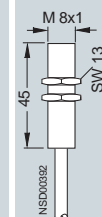



# SIMATIC PXI inductive proximity switches

## SIMATIC PXI300

Operating distance 3 mm

### Technical specifications

Class	Increased operating distance		Increased operating distance	
Number of wires	3-wire		3-wire	
Design	Ø 6.5 mm		M8	
Installation in metal	Almost flush		Almost flush	
Rated operating distance $s_n$	3 mm		3 mm	
Enclosure material	Brass, nickel-plated		Brass, nickel-plated	
Operating voltage (DC)	V	10 ... 30	V	10 ... 30
No-load supply current $I_0$	mA	≤ 10	mA	≤ 10
Rated operational current $I_e$	mA	200	mA	200
Switching frequency $f$	Hz	1000	Hz	1000
Repeat accuracy $R$	mm	0.15	mm	0.15
Power-up delay $t_v$	ms	50	ms	50
Switching status display	Yellow LED		Yellow LED	
Precautions	<ul style="list-style-type: none"> <li>• Spurious signal suppression</li> <li>• Short-circuit-proof/overload-proof</li> <li>• Reverse-polarity protection</li> <li>• Wire-break protection</li> <li>• Inductive interference protection</li> <li>• Radio interference protection</li> </ul>		<ul style="list-style-type: none"> <li>•</li> <li>•</li> <li>•</li> <li>•</li> <li>•</li> <li>•</li> </ul>	
Degree of protection	IP67		IP67	

### Selection and Ordering data

Switching output	Circuit diagram number <sup>1)</sup>	Connector type <sup>2)</sup>	Order No.	Order No.
<b>With 2 m cable, PUR</b>				
NO contact, pnp	11	▶ B	3RG43 02-0AG01	▶ B 3RG43 11-0AG01
NO contact, npn	13	–	–	B 3RG43 11-0GB01
<b>With 8 mm combination plug</b>				
NO contact, pnp	2	A	▶ B 3RG43 02-7AG01	▶ B 3RG43 11-7AG01
<b>With M12 connector</b>				
NO contact, pnp	2	E, F	–	▶ B 3RG43 11-3AG01
NC contact, pnp	3	F	–	B 3RG43 11-3AF01
NO contact, npn	4	E, F	–	B 3RG43 11-3GB01

1) See page 2/242.

2) See from page 2/268.

▶ Preferred type, available from stock.

B: Subject to export regulations AL = N and ECCN = EAR99.

### Dimensions

#### Mounting instructions

Dimension depending on form

A = active surface

B = metal-free area

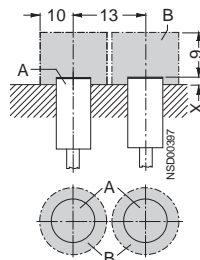

$X \geq 1.3$  mm when mounted in steel,  
 $X \geq 0.65$  mm when mounted in other metal

3RG43 02-0AG01

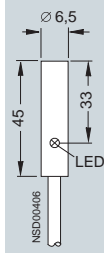

3RG43 02-7AG01

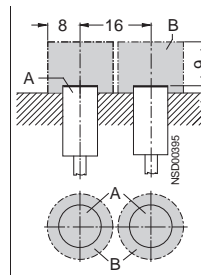
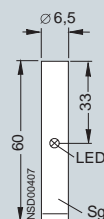

$X \geq 1.6$  mm when mounted in steel,  
 $X \geq 0.8$  mm when mounted in other metal

3RG43 11-0..01

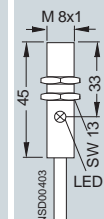

3RG43 11-7..01

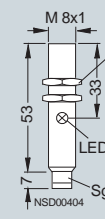

3RG43 11-3..01

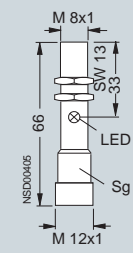

### Technical specifications

<b>Class</b>	<b>Increased operating distance</b>	
<b>Number of wires</b>	<b>3-wire</b>	
<b>Design</b>	<b>8 mm × 8 mm</b>	
<b>Installation in metal</b>	<b>Almost flush</b>	
<b>Rated operating distance <math>s_n</math></b>	<b>3 mm</b>	
Enclosure material	Brass, nickel-plated	
Operating voltage (DC)	V	10 ... 30
No-load supply current $I_0$	mA	≤ 10
Rated operational current $I_e$	mA	200
Switching frequency $f$	Hz	1000
Repeat accuracy $R$	mm	0.15
Power-up delay $t_v$	ms	50
Switching status display	Yellow LED	
Precautions	<ul style="list-style-type: none"> <li>• Spurious signal suppression</li> <li>• Short-circuit-proof/overload-proof</li> <li>• Reverse-polarity protection</li> <li>• Wire-break protection</li> <li>• Inductive interference protection</li> <li>• Radio interference protection</li> </ul>	
Degree of protection	IP67	

### Selection and Ordering data

Switching output	Circuit diagram number <sup>1)</sup>	Connector type <sup>2)</sup>	Order No.
<b>With 2 m cable, PUR</b>			$3 \times 0.14 \text{ mm}^2$
NO contact, pnp	11	▶ B	<b>3RG43 37-0AG01</b>
NO contact, npn	13		<b>3RG43 37-0GB01</b>
<b>With 8 mm combination plug</b>			
NO contact, pnp	2	A ▶ B	<b>3RG43 37-7AG01</b>
NO contact, npn	4	A B	<b>3RG43 37-7GB01</b>

1) See page 2/242.

2) See from page 2/268.

▶ Preferred type, available from stock.

B: Subject to export regulations AL = N and ECCN = EAR99.

### Dimensions

#### Mounting instructions

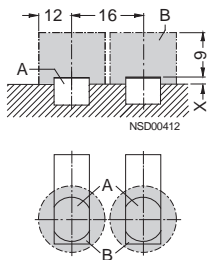
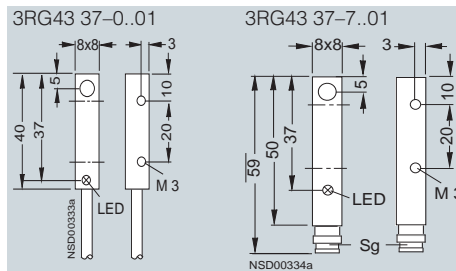
A = active surface  
B = metal-free area $X \geq 2,4 \text{ mm}$  when mounted in steel, $X \geq 1,2 \text{ mm}$  when mounted in other metal

# SIMATIC PXI inductive proximity switches

## SIMATIC PXI300

Operating distance 4 mm

### Technical specifications

Class		Extra duty (65 V DC)	Extra duty (AC/DC)
Number of wires		3-wire	2-wire
Design		M12	M12
Installation in metal		Not flush	Not flush
Rated operating distance $s_n$		4 mm	4 mm
Enclosure material		Brass, nickel-plated	Brass, nickel-plated
Operating voltage			
• DC	V	10 ... 65	20 ... 320
• AC	V	–	20 ... 265
No-load supply current $I_0$			
• At 24 V DC	mA	≤ 10	1.0
• At 230 V AC	mA	–	1.5
Rated operational current $I_e$			
• Continuous	mA	300	200
• 20 ms	mA	–	1200
Minimum load current	mA	–	5
Switching frequency $f$	Hz	800	25/900 (AC/DC)
Repeat accuracy $R$	mm	0.2	0.12
Power-up delay $t_v$	ms	40	100
Switching status display		Yellow LED	Yellow LED
Precautions			
• Spurious signal suppression	•	•	•
• Short-circuit-proof/overload-proof	•	–	–
• Reverse-polarity protection	•	•	•
• Wire-break protection	•	•	•
• Inductive interference protection	•	•	•
• Radio interference protection	•	•	•
Degree of protection		IP67	IP67

### Selection and Ordering data

Switching output	Circuit diagram number <sup>1)</sup>	Connector type <sup>2)</sup>	Order No.	Order No.
<b>With 2 m cable, PUR</b>				
NO contact, pnp	11	▶ B	3RG40 22-0AB00	–
NC contact, pnp	12	–	3RG40 22-0AA00	–
NO contact	16	–	–	▶ B 3RG40 22-0KB00
NC contact	17	–	–	B 3RG40 22-0KA00
<b>With M12 connector</b>				
NO contact, pnp	2	E, F	▶ B 3RG40 22-3AB00	–
NC contact, pnp	3	F	3RG40 22-3AA00	–
NO contact	8	E, F	–	▶ B 3RG40 22-3KB00
NC contact	9	F	–	B 3RG40 22-3KA00

1) See page 2/242.

2) See from page 2/268.

▶ Preferred type, available from stock.

B: Subject to export regulations AL = N and ECCN = EAR99.

### Dimensions

#### Mounting instructions

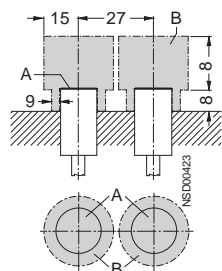

A = active surface  
B = metal-free area

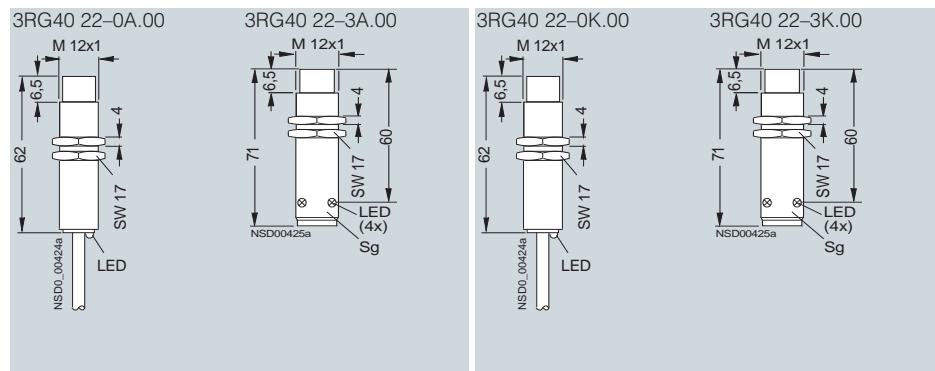

# SIMATIC PXI inductive proximity switches

## SIMATIC PXI300

Operating distance 4 mm

### Technical specifications

Class	IP68 / 69 K	IP68 / 69 K	IP68 / 69 K
Number of wires	3-wire	3-wire	3-wire
Design	Ø 12 mm	M12	M12
Installation in metal	Not flush	Not flush	Not flush
Rated operating distance $s_n$	4 mm	4 mm	4 mm
Enclosure material	Molded plastic	Molded plastic	Brass, nickel-plated
Operating voltage (DC)	V 15 ... 34	15 ... 34	15 ... 34
No-load supply current $I_0$	mA $\leq 17$ (24 V); $\leq 30$ (34 V)	$\leq 17$ (24 V); $\leq 30$ (34 V)	$\leq 17$ (24 V); $\leq 30$ (34 V)
Rated operational current $I_e$	mA 200 ( $\leq 50$ °C); 150 ( $\leq 85$ °C)	200 ( $\leq 50$ °C); 150 ( $\leq 85$ °C)	200 ( $\leq 50$ °C); 150 ( $\leq 85$ °C)
Switching frequency $f$	Hz 800	800	800
Repeat accuracy $R$	mm 0.2	0.2	0.2
Power-up delay $t_v$	ms 40	40	40
Switching status display	Yellow LED	Yellow LED	Yellow LED
Precautions	<ul style="list-style-type: none"> <li>• Spurious signal suppression</li> <li>• Short-circuit-proof/overload-proof</li> <li>• Reverse-polarity protection</li> <li>• Wire-break protection</li> <li>• Inductive interference protection</li> <li>• Radio interference protection</li> </ul>	<ul style="list-style-type: none"> <li>•</li> <li>•</li> <li>•</li> <li>•</li> <li>•</li> <li>•</li> </ul>	<ul style="list-style-type: none"> <li>•</li> <li>•</li> <li>•</li> <li>•</li> <li>•</li> <li>•</li> </ul>
Degree of protection	IP68 / 69 K	IP68 / 69 K	IP68 / 69 K

### Selection and Ordering data

Switching output	Circuit diagram number <sup>1)</sup>	Connector type <sup>2)</sup>	Order No.	Order No.	Order No.
<b>With 2 m cable</b>			PUR, 3 × 0.25 mm <sup>2</sup>	PUR, 3 × 0.25 mm <sup>2</sup>	PVC, 3 × 0.25 mm <sup>2</sup>
NO contact, pnp	11	B	<b>3RG40 62-0AG30</b>	B <b>3RG40 22-0AG30</b>	B <b>3RG40 22-0AG31</b>
NC contact, pnp	12	B	<b>3RG40 62-0AF30</b>	B <b>3RG40 22-0AF30</b>	—
NO contact, npn	13	B	<b>3RG40 62-0GB30</b>	B <b>3RG40 22-0GB30</b>	B <b>3RG40 22-0GB31</b>
NC contact, npn	14	B	<b>3RG40 62-0GA30</b>	B <b>3RG40 22-0GA30</b>	—
<b>With M12 connector</b>					
NO contact, pnp	2	E, F	—	—	B <b>3RG40 22-3AG31</b>

1) See page 2/242.

2) See from page 2/268.

B: Subject to export regulations AL = N and ECCN = EAR99.

### Dimensions

#### Mounting instructions

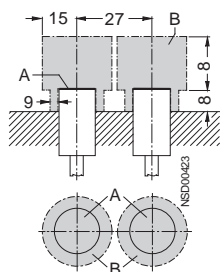

A = active surface  
B = metal-free area

3RG40 62-0..30

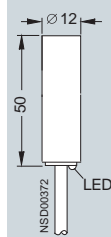

3RG40 22-0..30

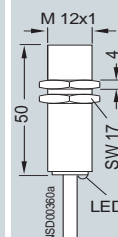

3RG40 22-0..31 3RG40 22-3..31

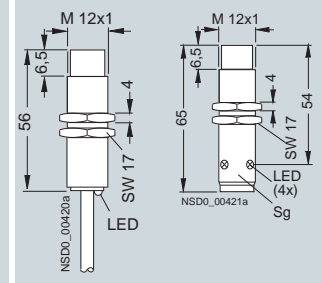

# SIMATIC PXI inductive proximity switches

## SIMATIC PXI300

Operating distance 4 mm

### Technical specifications

Class	IP68 / 69 K (DC 65 V)		IP68 / 69 K (AC/DC)
Number of wires	3-wire		2-wire
Design	M12		M12
Installation in metal	Not flush		Not flush
Rated operating distance $s_n$	4 mm		4 mm
Enclosure material	Molded plastic		Molded plastic
Operating voltage			
• DC	V	10 ... 65	20 ... 320
• AC	V	–	20 ... 265
No-load supply current $I_0$			
• At 24 V DC	mA	≤ 10	1.0
• At 230 V AC	mA	–	1.5
Rated operational current $I_e$			
• Continuous	mA	300	200
• 20 ms	mA	–	1200
Minimum load current	mA	–	5
Switching frequency $f$	Hz	800	25/900 (AC/DC)
Repeat accuracy $R$	mm	0.2	0.12
Power-up delay $t_v$	ms	40	100
Switching status display	Yellow LED		Yellow LED
Precautions			
• Spurious signal suppression	•		•
• Short-circuit-proof/overload-proof	•		–
• Reverse-polarity protection	•		•
• Wire-break protection	•		•
• Inductive interference protection	•		•
• Radio interference protection	•		•
Degree of protection	IP68 / 69 K		IP68 / 69 K

### Selection and Ordering data

Switching output	Circuit diagram number <sup>1)</sup>	Connector type <sup>2)</sup>	Order No.	Order No.
<b>With 2 m cable, PUR</b>				
NO contact, pnp	11	▶ B	3RG40 22-0AB30	–
NC contact, pnp	12		3RG40 22-0AA30	–
NO contact	16	E, F	–	B 3RG40 22-0KB30
NC contact	17		–	3RG40 22-3KA30
<b>With M12 connector</b>				
NO contact, pnp	2	E, F	B 3RG40 22-3AB30	–
NO contact	8	E, F	–	B 3RG40 22-3KB30

1) See page 2/242.

2) See from page 2/268.

▶ Preferred type, available from stock.

B: Subject to export regulations AL = N and ECCN = EAR99.

### Dimensions

#### Mounting instructions

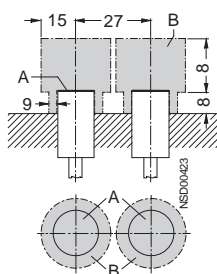

A = active surface  
B = metal-free area

3RG40 22-0..30

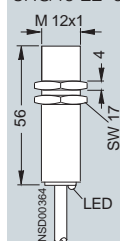

3RG40 22-3..30

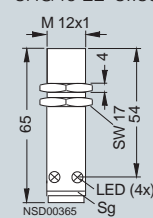

### Technical specifications

Class	Increased operating distance		Increased operating distance	
Number of wires	3-wire		3-wire	
Design	M12, Shorty		M12	
Installation in metal	Flush		Flush	
Rated operating distance $s_n$	4 mm		4 mm	
Enclosure material	Brass, nickel-plated		Brass, nickel-plated	
Operating voltage (DC)	V	10 ... 34	10 ... 34	
No-load supply current $I_0$	mA	$\leq 17$ (24 V); $\leq 30$ (34 V)	$\leq 17$ (24 V); $\leq 30$ (34 V)	
Rated operational current $I_e$	mA	200 ( $\leq 50$ °C); 150 ( $\leq 85$ °C)	200 ( $\leq 50$ °C); 150 ( $\leq 85$ °C)	
Switching frequency $f$	Hz	400	400	
Repeat accuracy $R$	mm	0.2	0.2	
Power-up delay $t_v$	ms	40	40	
Switching status display	Yellow LED		Yellow LED	
Precautions	<ul style="list-style-type: none"> <li>• Spurious signal suppression</li> <li>• Short-circuit-proof/overload-proof</li> <li>• Reverse-polarity protection</li> <li>• Wire-break protection</li> <li>• Inductive interference protection</li> <li>• Radio interference protection</li> </ul>		<ul style="list-style-type: none"> <li>•</li> <li>•</li> <li>•</li> <li>•</li> <li>•</li> <li>•</li> </ul>	
Degree of protection	IP67		IP67	

### Selection and Ordering data

Switching output	Circuit diagram number <sup>1)</sup>	Connector type <sup>2)</sup>	Order No.	Order No.
<b>With 2 m cable, PUR</b>			$3 \times 0.25 \text{ mm}^2$	$3 \times 0.25 \text{ mm}^2$
NO contact, pnp	11	B	<b>3RG41 12-0AG33</b>	▶ B <b>3RG41 12-0AG01</b>
NC contact, pnp	12	–	–	B <b>3RG41 12-0AF01</b>
<b>With M12 connector</b>				
NO contact, pnp	2	E, F	▶ B <b>3RG41 12-3AG33</b>	▶ B <b>3RG41 12-3AG01</b>
NC contact, pnp	3	F	<b>3RG41 12-3AF33</b>	B <b>3RG41 12-3AF01</b>

1) See page 2/242.

2) See from page 2/268.

▶ Preferred type, available from stock.

B: Subject to export regulations AL = N and ECCN = EAR99.

### Dimensions

#### Mounting instructions

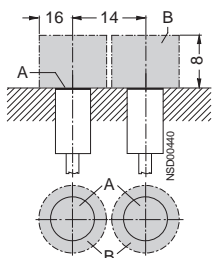
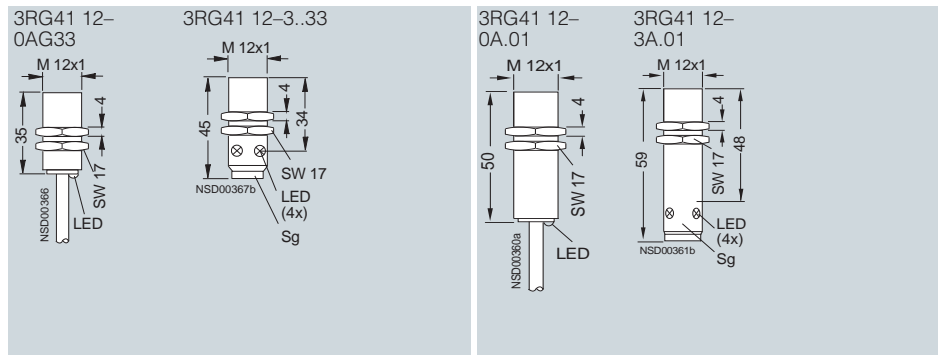
A = active surface  
B = metal-free area

# SIMATIC PXI inductive proximity switches

## SIMATIC PXI300

Operating distance 5 mm

### Technical specifications

<b>Class</b>	<b>Extra duty (65 V DC)</b>	
<b>Number of wires</b>	<b>3-wire</b>	
<b>Design</b>	<b>M14</b>	
<b>Installation in metal</b>	<b>Not flush</b>	
<b>Rated operating distance <math>s_n</math></b>	<b>5 mm</b>	
Enclosure material	Molded plastic	
Operating voltage (DC)	V	10 ... 65
No-load supply current $I_0$	mA	≤ 10
Rated operational current $I_e$	mA	300
Switching frequency $f$	Hz	300
Repeat accuracy $R$	mm	0.1
Power-up delay $t_v$	ms	40
Switching status display	Yellow LED	
Precautions	<ul style="list-style-type: none"> <li>• Spurious signal suppression</li> <li>• Short-circuit-proof/overload-proof</li> <li>• Reverse-polarity protection</li> <li>• Wire-break protection</li> <li>• Inductive interference protection</li> <li>• Radio interference protection</li> </ul>	
Degree of protection	IP67	

### Selection and Ordering data

Switching output	Circuit diagram number <sup>1)</sup>	Connector type <sup>2)</sup>	Order No.
<b>With 2 m cable, PUR</b>			$3 \times 0.25 \text{ mm}^2$
NO contact, pnp	13	▶ B	<b>3RG40 82-0AB00</b>
<b>With M12 connector</b>			
NO contact, pnp	4	E, F ▶ B	<b>3RG40 82-3AB00</b>

1) See page 2/242.

2) See from page 2/268.

▶ Preferred type, available from stock.

B: Subject to export regulations AL = N and ECCN = EAR99.

### Dimensions

#### Mounting instructions

3RG40 82

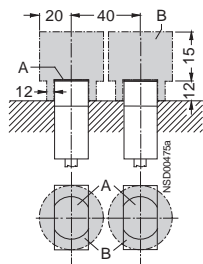

A = active surface  
B = metal-free area

3RG40 82-3..00

Plan view:

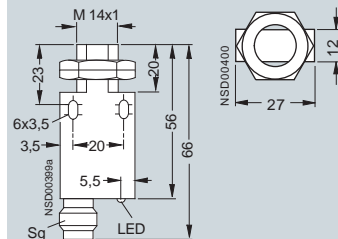

# SIMATIC PXI inductive proximity switches

## SIMATIC PXI300

**Operating distance 5 mm**

### Technical specifications

Class		Extra duty (65 V DC)	Extra duty (AC/DC)
Number of wires		3-wire	2-wire
Design		M18	M18
Installation in metal		Flush	Flush
Rated operating distance $s_n$		5 mm	5 mm
Enclosure material		Brass, nickel-plated	Brass, nickel-plated
Operating voltage			
• DC	V	10 ... 65	20 ... 320
• AC	V	–	20 ... 265
No-load supply current $I_0$			
• At 24 V DC	mA	≤ 10	1.0
• At 230 V AC	mA	–	1.5
Rated operational current $I_e$			
• Continuous	mA	300	300
• 20 ms	mA	–	1800
Minimum load current	mA	–	5
Switching frequency $f$	Hz	800 (NO contact), 4000 (NC contact)	25/490 (AC/DC)
Repeat accuracy $R$	mm	0.15	0.15
Power-up delay $t_v$	ms	40	100
Switching status display		Yellow LED	Yellow LED
Precautions			
• Spurious signal suppression		•	•
• Short-circuit-proof/overload-proof		•	–
• Reverse-polarity protection		•	•
• Wire-break protection		•	•
• Inductive interference protection		•	•
• Radio interference protection		•	•
Degree of protection		IP67	IP67

### Selection and Ordering data

Switching output	Circuit diagram number <sup>1)</sup>	Connector type <sup>2)</sup>	Order No.	Order No.
<b>With 2 m cable, PUR</b>				
NO contact, pnp	11	▶ B	3RG40 13-0AB00	–
NC contact, pnp	12	▶ B	3RG40 13-0AA00	–
NO contact	16	–	–	▶ B 3RG40 13-0KB00
NC contact	17	–	–	▶ B 3RG40 13-0KA00
<b>With M12 connector</b>				
NO contact, pnp	2	E, F	▶ B 3RG40 13-3AB00	–
NC contact, pnp	3	F	B 3RG40 13-3AA00	–
NO contact	8	E, F	–	▶ B 3RG40 13-3KB00
NC contact	9	F	–	B 3RG40 13-3KA00

1) See page 2/242.

2) See from page 2/268.

▶ Preferred type, available from stock.

B: Subject to export regulations AL = N and ECCN = EAR99.

### Dimensions

#### Mounting instructions

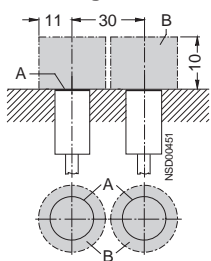

A = active surface  
B = metal-free area

3RG40 13-0...00  
3RG40 13-0...01

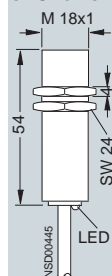

3RG40 13-3...00  
3RG40 13-3...01

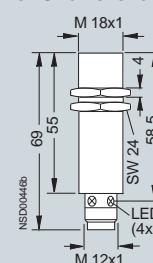



# SIMATIC PXI inductive proximity switches

## SIMATIC PXI300

Operating distance 5 mm

### Technical specifications

Class	IP68 / 69 K	IP68 / 69 K	IP68 / 69 K
Number of wires	3-wire	3-wire	3-wire
Design	Ø 18 mm	M18	M18
Installation in metal	Flush	Flush	Flush
Rated operating distance $s_n$	5 mm	5 mm	5 mm
Enclosure material	Molded plastic	Molded plastic	Brass, nickel-plated
Operating voltage (DC)	V 15 ... 34	15 ... 34	15 ... 34
No-load supply current $I_0$	mA ≤ 17 (24 V); ≤ 30 (34 V)	≤ 17 (24 V); ≤ 30 (34 V)	≤ 17 (24 V); ≤ 30 (34 V)
Rated operational current $I_e$	mA 200 (≤ 50 °C); 150 (≤ 85 °C)	200 (≤ 50 °C); 150 (≤ 85 °C)	200 (≤ 50 °C); 150 (≤ 85 °C)
Switching frequency $f$	Hz 800	800	800
Repeat accuracy $R$	mm 0.15	0.15	0.15
Power-up delay $t_v$	ms 40	40	40
Switching status display	Yellow LED	Yellow LED	Yellow LED
Precautions	<ul style="list-style-type: none"> <li>• Spurious signal suppression</li> <li>• Short-circuit-proof/overload-proof</li> <li>• Reverse-polarity protection</li> <li>• Wire-break protection</li> <li>• Inductive interference protection</li> <li>• Radio interference protection</li> </ul>	<ul style="list-style-type: none"> <li>•</li> <li>•</li> <li>•</li> <li>•</li> <li>•</li> <li>•</li> </ul>	<ul style="list-style-type: none"> <li>•</li> <li>•</li> <li>•</li> <li>•</li> <li>•</li> <li>•</li> </ul>
Degree of protection	IP68 / 69 K	IP68 / 69 K	IP68 / 69 K

### Selection and Ordering data

Switching output	Circuit diagram number <sup>1)</sup>	Connector type <sup>2)</sup>	Order No.	Order No.	Order No.
<b>With 2 m cable, PUR</b>			PUR, 3 × 0.25 mm <sup>2</sup>	PUR, 3 × 0.25 mm <sup>2</sup>	PVC, 3 × 0.25 mm <sup>2</sup>
NO contact, pnp	11	B	<b>3RG40 53-0AG30</b>	B <b>3RG40 13-0AG30</b>	B <b>3RG40 13-0AG31</b>
NC contact, pnp	12	B	<b>3RG40 53-0AF30</b>	B <b>3RG40 13-0AF30</b>	—
NO contact, npn	13	B	<b>3RG40 53-0GB30</b>	B <b>3RG40 13-0GB30</b>	B <b>3RG40 13-0GB31</b>
NC contact, npn	14	B	<b>3RG40 53-0GA30</b>	B <b>3RG40 13-0GA30</b>	—
<b>With M12 connector</b>			—	—	B <b>3RG40 13-3AG31</b>
NO contact, pnp	2	E, F	—	—	B <b>3RG40 13-3AG31</b>

1) See page 2/242.

2) See from page 2/268.

B: Subject to export regulations AL = N and ECCN = EAR99.

### Dimensions

#### Mounting instructions

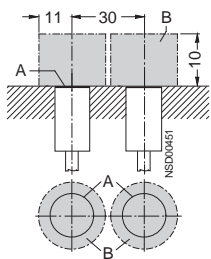

A = active surface  
B = metal-free area

3RG40 53-0..30

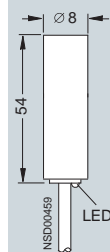

3RG40 13-0..30

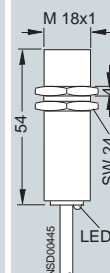

3RG40 13-0..31 3RG40 13-3AG31

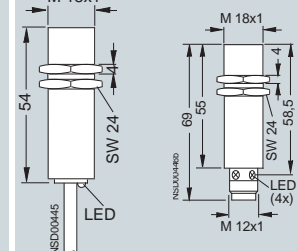

## Technical specifications

Class	Increased operating distance		Increased operating distance	
Number of wires	3-wire		3-wire	
Design	M8		M12	
Installation in metal	Not flush		Almost flush	
Rated operating distance $s_n$	6 mm		6 mm	
Enclosure material	Brass, nickel-plated		Brass, nickel-plated	
Operating voltage (DC)	V	10 ... 30	V	10 ... 30
No-load supply current $I_0$	mA	≤ 10	mA	≤ 10
Rated operational current $I_e$	mA	200	mA	200
Switching frequency $f$	Hz	500	Hz	800
Repeat accuracy $R$	mm	0.15	mm	0.15
Power-up delay $t_v$	ms	15	ms	15
Switching status display	Yellow LED		Yellow LED	
Precautions	<ul style="list-style-type: none"> <li>• Spurious signal suppression</li> <li>• Short-circuit-proof/overload-proof</li> <li>• Reverse-polarity protection</li> <li>• Wire-break protection</li> <li>• Inductive interference protection</li> <li>• Radio interference protection</li> </ul>		<ul style="list-style-type: none"> <li>•</li> <li>•</li> <li>•</li> <li>•</li> <li>•</li> <li>•</li> </ul>	
Degree of protection	IP67		IP67	

## Selection and Ordering data

Switching output	Circuit diagram number <sup>1)</sup>	Connector type <sup>2)</sup>	Order No.	Order No.
<b>With 2 m cable, PUR</b>			3 × 0.14 mm <sup>2</sup>	3 × 0.34 mm <sup>2</sup>
NO contact, pnp	11	▶ B	<b>3RG43 21-0AG01</b>	▶ B <b>3RG43 12-0AG01</b>
NC contact, pnp	12	B	<b>3RG43 21-0AF01</b>	<b>3RG43 12-0AF01</b>
NO contact, npn	13	B	<b>3RG43 21-0GB01</b>	B <b>3RG43 12-0GB01</b>
NC contact, npn	14	B	<b>3RG43 21-0GA01</b>	—
<b>With 8 mm combination plug</b>				
NO contact, pnp	2	A	▶ B <b>3RG43 21-7AG01</b>	—
NC contact, pnp	3	A	B <b>3RG43 21-7AF01</b>	—
NO contact, npn	4	A	B <b>3RG43 21-7GB01</b>	—
NC contact, npn	5	A	B <b>3RG43 21-7GA01</b>	—
<b>With M12 connector</b>				
NO contact, pnp	2	E, F	▶ B <b>3RG43 21-3AG01</b>	▶ B <b>3RG43 12-3AG01</b>
NC contact, pnp	3	F	B <b>3RG43 21-3AF01</b>	<b>3RG43 12-3AF01</b>
NO contact, npn	4	E, F	B <b>3RG43 21-3GB01</b>	B <b>3RG43 12-3GB01</b>
NC contact, npn	5	F	B <b>3RG43 21-3GA01</b>	—

1) See page 2/242.

2) See from page 2/268.

▶ Preferred type, available from stock.

B: Subject to export regulations AL = N and ECCN = EAR99.

## Dimensions

## Mounting instructions

Dimension depending on form

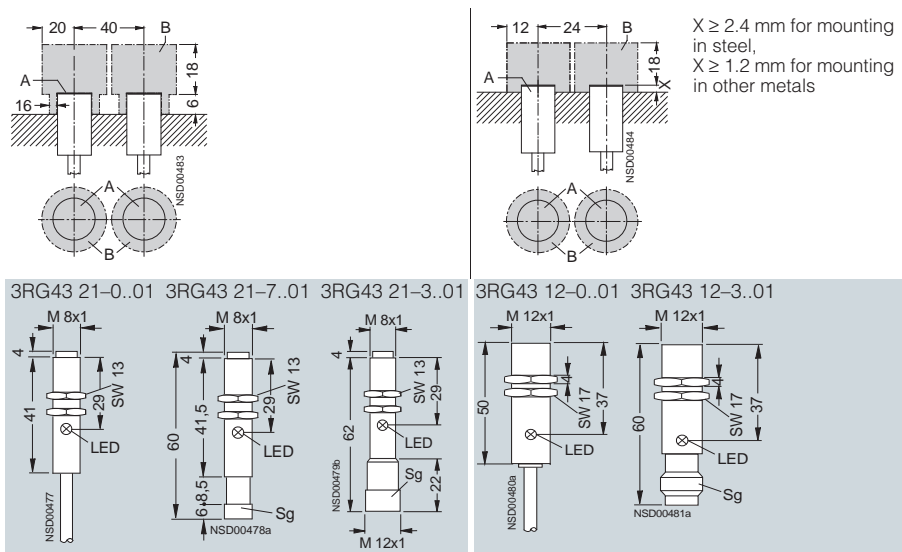
A = active surface  
B = metal-free area

# SIMATIC PXI inductive proximity switches

## SIMATIC PXI300

Operating distance 8 mm

### Technical specifications

Class		Extra duty (65 V DC)	Extra duty (AC/DC)
Number of wires		3-wire	2-wire
Design		M18	M18
Installation in metal		Not flush	Not flush
Rated operating distance $s_n$		8 mm	8 mm
Enclosure material		Brass, nickel-plated	Brass, nickel-plated
Operating voltage			
• DC	V	10 ... 65	20 ... 320
• AC	V	–	20 ... 265
No-load supply current $I_0$			
• At 24 V DC	mA	≤ 10	1.0
• At 230 V AC	mA	–	1.5
Rated operational current $I_e$			
• Continuous	mA	300	300
• 20 ms	mA	–	1800
Minimum load current	mA	–	5
Switching frequency $f$	Hz	500	25/340 (AC/DC)
Repeat accuracy $R$	mm	0.2	0.2
Power-up delay $t_v$	ms	40	100
Switching status display		Yellow LED	Yellow LED
Precautions			
• Spurious signal suppression	•		•
• Short-circuit-proof/overload-proof	•		–
• Reverse-polarity protection	•		•
• Wire-break protection	•		•
• Inductive interference protection	•		•
• Radio interference protection	•		•
Degree of protection		IP67	IP67

### Selection and Ordering data

Switching output	Circuit diagram number <sup>1)</sup>	Connector type <sup>2)</sup>	Order No.	Order No.
<b>With 2 m cable, PUR</b>			3 × 0.25 mm <sup>2</sup>	2 × 0.25 mm <sup>2</sup>
NO contact, pnp	11	▶ B	<b>3RG40 23-0AB00</b>	–
NC contact, pnp	12	▶ B	<b>3RG40 23-0AA00</b>	–
NO contact	16	–	–	▶ B <b>3RG40 23-0KB00</b>
NC contact	17	–	–	B <b>3RG40 23-0KA00</b>
<b>With M12 connector</b>				
NO contact, pnp	2	E, F	▶ B <b>3RG40 23-3AB00</b>	–
NC contact, pnp	3	F	B <b>3RG40 23-3AA00</b>	–
NO contact	8	E, F	–	▶ B <b>3RG40 23-3KB00</b>
NC contact	9	F	–	B <b>3RG40 23-3KA00</b>

1) See page 2/242.

2) See from page 2/268.

▶ Preferred type, available from stock.

B: Subject to export regulations AL = N and ECCN = EAR99.

### Dimensions

#### Mounting instructions

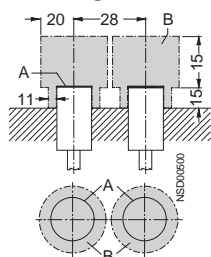

A = active surface  
B = metal-free area

3RG40 23-0..00  
3RG40 23-0..01

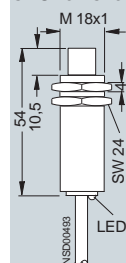

3RG40 23-3..00  
3RG40 23-3..01

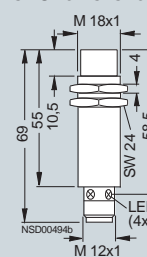

## Technical specifications

Class	IP68 / 69 K	IP68 / 69 K	IP68 / 69 K
Number of wires	3-wire	3-wire	3-wire
Design	Ø 18 mm	M18	M18
Installation in metal	Not flush	Not flush	Not flush
Rated operating distance $s_n$	8 mm	8 mm	8 mm
Enclosure material	Molded plastic	Molded plastic	Brass, nickel-plated
Operating voltage (DC)	V 15 ... 34	15 ... 34	15 ... 34
No-load supply current $I_0$	mA $\leq 17$ (24 V); $\leq 30$ (34 V)	$\leq 17$ (24 V); $\leq 30$ (34 V)	$\leq 17$ (24 V); $\leq 30$ (34 V)
Rated operational current $I_e$	mA 200 ( $\leq 50$ °C); 150 ( $\leq 85$ °C)	200 ( $\leq 50$ °C); 150 ( $\leq 85$ °C)	200 ( $\leq 50$ °C); 150 ( $\leq 85$ °C)
Switching frequency $f$	Hz 300	300	300
Repeat accuracy $R$	mm 0.2	0.2	0.2
Power-up delay $t_v$	ms 40	40	40
Switching status display	Yellow LED	Yellow LED	Yellow LED
Precautions	<ul style="list-style-type: none"> <li>• Spurious signal suppression</li> <li>• Short-circuit-proof/overload-proof</li> <li>• Reverse-polarity protection</li> <li>• Wire-break protection</li> <li>• Inductive interference protection</li> <li>• Radio interference protection</li> </ul>	<ul style="list-style-type: none"> <li>•</li> <li>•</li> <li>•</li> <li>•</li> <li>•</li> <li>•</li> </ul>	<ul style="list-style-type: none"> <li>•</li> <li>•</li> <li>•</li> <li>•</li> <li>•</li> <li>•</li> </ul>
Degree of protection	IP68 / 69 K	IP68 / 69 K	IP68 / 69 K

## Selection and Ordering data

Switching output	Circuit diagram number <sup>1)</sup>	Connector type <sup>2)</sup>	Order No.	Order No.	Order No.
<b>With 2 m cable</b>			PUR, 3 × 0.25 mm <sup>2</sup>	PUR, 3 × 0.25 mm <sup>2</sup>	PVC, 3 × 0.25 mm <sup>2</sup>
NO contact, pnp	11	B	<b>3RG40 63-0AG30</b>	B <b>3RG40 23-0AG30</b>	B <b>3RG40 23-0AG31</b>
NC contact, pnp	12	B	<b>3RG40 63-0AF30</b>	B <b>3RG40 23-0AF30</b>	—
NO contact, npn	13	B	<b>3RG40 63-0GB30</b>	B <b>3RG40 23-0GB30</b>	B <b>3RG40 23-0GB31</b>
NC contact, npn	14	B	<b>3RG40 63-0GA30</b>	B <b>3RG40 23-0GA30</b>	—
<b>With M12 connector</b>			—	—	B <b>3RG40 23-3AG31</b>
NO contact, pnp	2	E, F	—	—	B <b>3RG40 23-3AG31</b>

1) See page 2/242.

2) See from page 2/268.

B: Subject to export regulations AL = N and ECCN = EAR99.

## Dimensions

## Mounting instructions

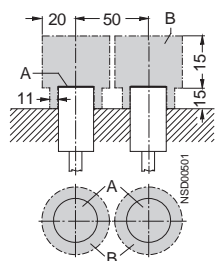
A = active surface  
B = metal-free area

3RG40 63-0..30

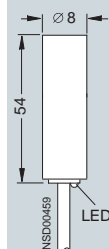

3RG40 23-0..30

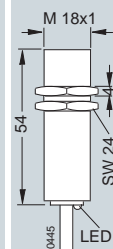

3RG40 23-0..31 3RG40 23-3..31

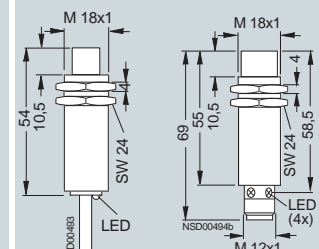

# SIMATIC PXI inductive proximity switches

## SIMATIC PXI300

Operating distance 8 mm

### Technical specifications

Class	IP68 / 69 K (65 V DC)		IP68 / 69 K (AC/DC)
Number of wires	3-wire		2-wire
Design	M18		M18
Installation in metal	Not flush		Not flush
Rated operating distance $s_n$	8 mm		8 mm
Enclosure material	Molded plastic		Molded plastic
Operating voltage			
• DC	V	10 ... 65	20 ... 320
• AC	V	–	20 ... 265
No-load supply current $I_0$			
• At 24 V DC	mA	≤ 10	1.0
• At 230 V AC	mA	–	1.5
Rated operational current $I_e$			
• Continuous	mA	300	300
• 20 ms	mA	–	1800
Minimum load current	mA	–	5
Switching frequency $f$	Hz	500	25/340 (AC/DC)
Repeat accuracy $R$	mm	0.2	0.2
Power-up delay $t_v$	ms	40	100
Switching status display	Yellow LED		Yellow LED
Precautions			
• Spurious signal suppression	•		•
• Short-circuit-proof/overload-proof	•		–
• Reverse-polarity protection	•		•
• Wire-break protection	•		•
• Inductive interference protection	•		•
• Radio interference protection	•		•
Degree of protection	IP68 / 69 K		IP68 / 69 K

### Selection and Ordering data

Switching output	Circuit diagram number <sup>1)</sup>	Connector type <sup>2)</sup>	Order No.	Order No.
<b>With 2 m cable, PUR</b>			3 × 0.25 mm <sup>2</sup>	2 × 0.25 mm <sup>2</sup>
NO contact, pnp	11	B	<b>3RG40 23-0AB30</b>	–
NC contact, pnp	12	B	<b>3RG40 23-0AA30</b>	–
NO contact	16	–	–	▶ B <b>3RG40 23-0KB30</b>
NC contact	17	–	–	B <b>3RG40 23-0KA30</b>
<b>With M12 connector</b>				
NO contact, pnp	2	E, F	B <b>3RG40 23-3AB30</b>	–
NC contact, pnp	3	F	B <b>3RG40 23-3AA30</b>	–
NO contact	8	E, F	–	B <b>3RG40 23-3KB30</b>
NC contact	9	F	–	<b>3RG40 23-3KA30</b>

1) See page 2/242.

2) See from page 2/268.

B: Subject to export regulations AL = N and ECCN = EAR99.

### Dimensions

#### Mounting instructions

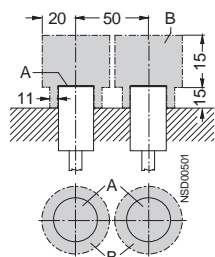

A = active surface  
B = metal-free area

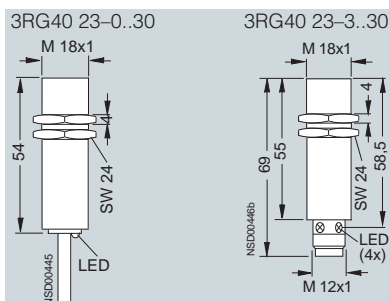

# SIMATIC PXI inductive proximity switches

## SIMATIC PXI300

Operating distance 8 mm

2

### Technical specifications

Class	Increased operating distance	
Number of wires	3-wire	3-wire
Design	M18, Shorty	M18
Installation in metal	Flush	Flush
Rated operating distance $s_n$	8 mm	8 mm
Enclosure material	Brass, nickel-plated	Brass, nickel-plated
Operating voltage (DC)	V 10 ... 34	10 ... 34
No-load supply current $I_0$	mA $\leq 10$	$\leq 10$
Rated operational current $I_e$	mA 200	200
Switching frequency $f$	Hz 500	500
Repeat accuracy $R$	mm 0.2	0.2
Power-up delay $t_v$	ms 3	3
Switching status display	Yellow LED	Yellow LED
Precautions	<ul style="list-style-type: none"> <li>• Spurious signal suppression</li> <li>• Short-circuit-proof/overload-proof</li> <li>• Reverse-polarity protection</li> <li>• Wire-break protection</li> <li>• Inductive interference protection</li> <li>• Radio interference protection</li> </ul>	<ul style="list-style-type: none"> <li>•</li> <li>•</li> <li>•</li> <li>•</li> <li>•</li> <li>•</li> </ul>
Degree of protection	IP67	IP67

### Selection and Ordering data

Switching output	Circuit diagram number <sup>1)</sup>	Connector type <sup>2)</sup>	Order No.	Order No.
<b>With 2 m cable, PUR</b>			3 × 0.25 mm <sup>2</sup>	
NO contact, pnp	11	B	<b>3RG41 13-0AG33</b>	-
<b>With 3 m cable, PUR</b>			3 × 0.25 mm <sup>2</sup>	
NO contact, pnp	11	-	-	B <b>3RG41 13-0AG01</b>
<b>With M12 connector</b>				
NO contact, pnp	2	E, F	B <b>3RG41 13-3AG33</b>	▶ B <b>3RG41 13-3AG01</b>

1) See page 2/242.  
 2) See from page 2/268.  
 ▶ Preferred type, available from stock.  
 B: Subject to export regulations AL = N and ECCN = EAR99.

### Dimensions

#### Mounting instructions

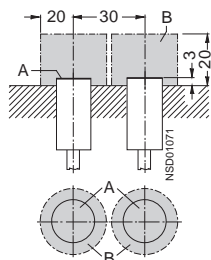

A = active surface  
 B = metal-free area

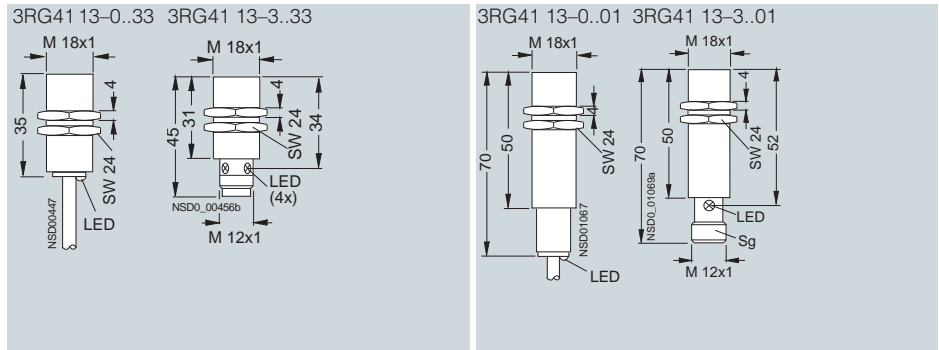

# SIMATIC PXI inductive proximity switches

## SIMATIC PXI300

Operating distance 10 mm

### Technical specifications

Class		Extra duty (65 V DC)	Extra duty (AC/DC)
Number of wires		3-wire	2-wire
Design		M30	M30
Installation in metal		Flush	Flush
Rated operating distance $s_n$		10 mm	10 mm
Enclosure material		Brass, nickel-plated	Brass, nickel-plated
Operating voltage			
• DC	V	10 ... 65	20 ... 320
• AC	V	–	20 ... 265
No-load supply current $I_0$			
• At 24 V DC	mA	≤ 10	1.0
• At 230 V AC	mA	–	1.5
Rated operational current $I_e$			
• Continuous	mA	300	300
• 20 ms	mA	–	1800
Minimum load current	mA	–	5
Switching frequency $f$	Hz	300	25/200 (AC/DC)
Repeat accuracy $R$	mm	0.3	0.3
Power-up delay $t_v$	ms	40	100
Switching status display		Yellow LED	Yellow LED
• Precautions			
• Spurious signal suppression	•		•
• Short-circuit-proof/overload-proof	•		–
• Reverse-polarity protection	•		•
• Wire-break protection	•		•
• Inductive interference protection	•		•
• Radio interference protection	•		•
Degree of protection		IP67	IP67

### Selection and Ordering data

Switching output	Circuit diagram number <sup>1)</sup>	Connector type <sup>2)</sup>	Order No.	Order No.
<b>With 2 m cable, PUR</b>			3 × 0.25 mm <sup>2</sup>	2 × 0.25 mm <sup>2</sup>
NO contact, pnp	11	▶ B	<b>3RG40 14-0AB00</b>	–
NC contact, pnp	12	B	<b>3RG40 14-0AA00</b>	–
NO contact	16	–	–	▶ B <b>3RG40 14-0KB00</b>
NC contact	17	–	–	▶ B <b>3RG40 14-0KA00</b>
<b>With M12 connector</b>				
NO contact, pnp	2	E, F	▶ B <b>3RG40 14-3AB00</b>	–
NC contact, pnp	3	F	B <b>3RG40 14-3AA00</b>	–
NO contact	8	E, F	–	▶ B <b>3RG40 14-3KB00</b>
NC contact	9	F	–	B <b>3RG40 14-3KA00</b>

1) See page 2/242.

2) See from page 2/268.

▶ Preferred type, available from stock.

B: Subject to export regulations AL = N and ECCN = EAR99.

### Dimensions

#### Mounting instructions

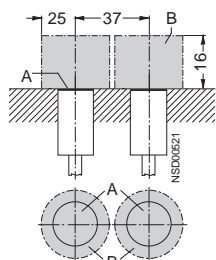

A = active surface  
B = metal-free area

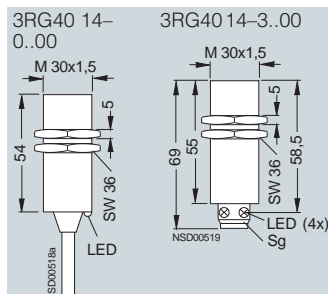

### Technical specifications

Class	IP68 / 69 K	IP68 / 69 K
Number of wires	3-wire	3-wire
Design	Ø 30 mm	M30
Installation in metal	Flush	Flush
Rated operating distance $s_n$	10 mm	10 mm
Enclosure material	Molded plastic	Molded plastic
Operating voltage (DC)	V 15 ... 34	15 ... 34
No-load supply current $I_0$	mA $\leq 17$ (24 V); $\leq 30$ (34 V)	$\leq 17$ (24 V); $\leq 30$ (34 V)
Rated operational current $I_e$	mA 200 ( $\leq 50$ °C); 150 ( $\leq 85$ °C)	200 ( $\leq 50$ °C); 150 ( $\leq 85$ °C)
Switching frequency $f$	Hz 300	300
Repeat accuracy $R$	mm 0.3	0.3
Power-up delay $t_v$	ms 40	40
Switching status display	Yellow LED	Yellow LED
Precautions	<ul style="list-style-type: none"> <li>• Spurious signal suppression</li> <li>• Short-circuit-proof/overload-proof</li> <li>• Reverse-polarity protection</li> <li>• Wire-break protection</li> <li>• Inductive interference protection</li> <li>• Radio interference protection</li> </ul>	<ul style="list-style-type: none"> <li>•</li> <li>•</li> <li>•</li> <li>•</li> <li>•</li> <li>•</li> </ul>
Degree of protection	IP68 / 69 K	IP68 / 69 K

### Selection and Ordering data

Switching output	Circuit diagram number <sup>1)</sup>	Order No.	Order No.
<b>With 2 m cable</b>		PUR, 3 × 0.25 mm <sup>2</sup>	PUR, 3 × 0.25 mm <sup>2</sup>
NO contact, pnp	11	B <b>3RG40 54-0AG30</b>	B <b>3RG40 14-0AG30</b>
NC contact, pnp	12	B <b>3RG40 54-0AF30</b>	B <b>3RG40 14-0AF30</b>
NO contact, npn	13	B <b>3RG40 54-0GB30</b>	B <b>3RG40 14-0GB30</b>
NC contact, npn	14	B <b>3RG40 54-0GA30</b>	B <b>3RG40 14-0GA30</b>

1) See page 2/242.

B: Subject to export regulations AL = N and ECCN = EAR99.

### Dimensions

#### Mounting instructions

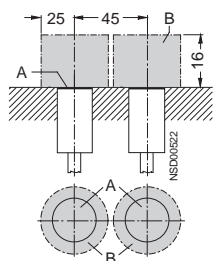

A = active surface  
B = metal-free area

3RG40 54-0..30

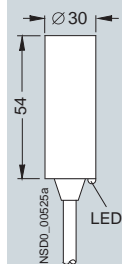

3RG40 14-0..30

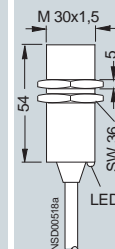



# SIMATIC PXI inductive proximity switches

## SIMATIC PXI300

Operating distance 10 mm

### Technical specifications

Class	IP68 / 69 K	IP68 / 69 K (AC/DC)
Number of wires	3-wire	2-wire
Design	M30	M30
Installation in metal	Flush	Flush
Rated operating distance $s_n$	10 mm	10 mm
Enclosure material	Brass, nickel-plated	Brass, nickel-plated
Operating voltage		
• DC	V 15 ... 34	20 ... 320
• AC	V	20 ... 265
No-load supply current $I_0$		
• At 24 V/34 V DC	mA ≤ 17 (24 V); ≤ 30 (34 V)	1.0
• At 230 V AC	mA -	1.5
Rated operational current $I_e$		
• Continuous	mA 200 (≤ 50 °C); 150 (≤ 85 °C)	300
• 20 ms	mA -	1800
Switching frequency $f$	Hz 300	25/200 (AC/DC)
Repeat accuracy $R$	mm 0.3	0.3
Power-up delay $t_v$	ms 40	100
Switching status display	Yellow LED	Yellow LED
Precautions		
• Spurious signal suppression	•	•
• Short-circuit-proof/overload-proof	•	-
• Reverse-polarity protection	•	•
• Wire-break protection	•	•
• Inductive interference protection	•	•
• Radio interference protection	•	•
Degree of protection	IP68 / 69 K	IP68 / 69 K

### Selection and Ordering data

Switching output	Circuit diagram number <sup>1)</sup>	Connector type <sup>2)</sup>	Order No.	Order No.
<b>With 2 m cable</b>			PVC, 3 × 0.25 mm <sup>2</sup>	PUR, 2 × 0.25 mm <sup>2</sup>
NO contact, pnp	11	B	<b>3RG40 14-0AG31</b>	-
NO contact, npn	13	B	<b>3RG40 14-0GB31</b>	-
NO contact	16	-	-	B <b>3RG40 14-0KB31</b>
NC contact	17	-	-	B <b>3RG40 14-0KA31</b>
<b>With M12 connector</b>				
NO contact	8	E, F	-	B <b>3RG40 14-3KB31</b>
NC contact	9	F	-	B <b>3RG40 14-3KA31</b>

1) See page 2/242.

2) See from page 2/268.

B: Subject to export regulations AL = N and ECCN = EAR99.

### Dimensions

#### Mounting instructions

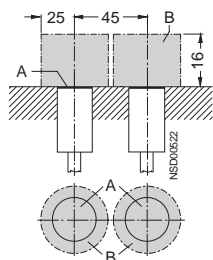

A = active surface  
B = metal-free area

3RG40 14-0..31

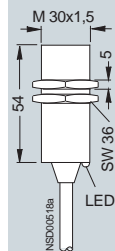

3RG40 14-0..31

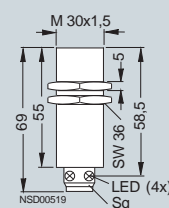

## Technical specifications

Class	Increased operating distance		Increased operating distance
Number of wires	3-wire		3-wire
Design	M12		M18
Installation in metal	Not flush		Almost flush
Rated operating distance $s_n$	10 mm		12 mm
Enclosure material	Brass, nickel-plated		Brass, nickel-plated
Operating voltage (DC)	V	10 ... 30	10 ... 30
No-load supply current $I_0$	mA	10	≤ 10
Rated operational current $I_e$	mA	200	200
Switching frequency $f$	Hz	400	500
Repeat accuracy $R$	mm	0.2	0.6
Power-up delay $t_v$	ms	15	50
Switching status display	Yellow LED		Yellow LED
Precautions	<ul style="list-style-type: none"> <li>• Spurious signal suppression</li> <li>• Short-circuit-proof/overload-proof</li> <li>• Reverse-polarity protection</li> <li>• Wire-break protection</li> <li>• Inductive interference protection</li> <li>• Radio interference protection</li> </ul>		<ul style="list-style-type: none"> <li>•</li> <li>•</li> <li>•</li> <li>•</li> <li>•</li> <li>•</li> </ul>
Degree of protection	IP67		IP67

## Selection and Ordering data

Switching output	Circuit diagram number <sup>1)</sup>	Connector type <sup>2)</sup>	Order No.	Order No.
<b>With 2 m cable, PUR</b>				
NO contact, pnp	11	▶ B	3RG43 22-0AG01	▶ 3RG46 13-1AB01
NO contact, npn	13		–	3RG46 13-0GB00
<b>With M12 connector</b>				
NO contact, pnp	2	E, F	▶ B 3RG43 22-3AG01	▶ 3RG46 13-3AB01
NC contact, pnp	3	F	B 3RG43 22-3AF01	–
NO contact, npn	4	E, F	–	3RG46 13-3GB01

1) See page 2/242.

2) See from page 2/268.

▶ Preferred type, available from stock.

B: Subject to export regulations AL = N and ECCN = EAR99.

## Dimensions

## Mounting instructions

3RG43 22

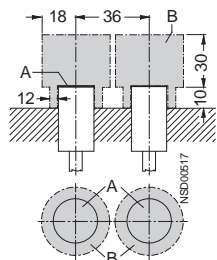

3RG46 13

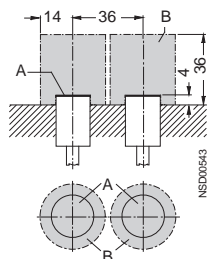
A = active surface  
B = metal-free area

3RG43 22-0AG01 3RG43 22-3..01

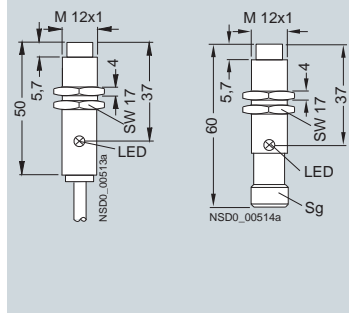

3RG46 13-1AB01 3RG46 13-0GB00 3RG46 13-3AB01 3RG46 13-3GB01

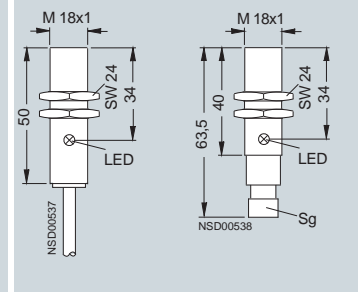

# SIMATIC PXI inductive proximity switches

## SIMATIC PXI300

### Operating distance 15 mm

#### Technical specifications

Class		Extra duty (65 V DC)	Extra duty (AC/DC)
Number of wires		3-wire	2-wire
Design		M30	M30
Installation in metal		Not flush	Not flush
Rated operating distance $s_n$		15 mm	15 mm
Enclosure material		Brass, nickel-plated	Brass, nickel-plated
Operating voltage			
• DC	V	10 ... 65	20 ... 320
• AC	V	–	20 ... 265
No-load supply current $I_0$			
• At 24 V DC	mA	≤ 10	1.0
• At 230 V AC	mA	–	1.5
Rated operational current $I_e$			
• Continuous	mA	300	300
• 20 ms	mA	–	1800
Minimum load current	mA	–	5
Switching frequency $f$	Hz	300	25/220 (AC/DC)
Repeat accuracy $R$	mm	0.4	0.4
Power-up delay $t_v$	ms	40	100
Switching status display		Yellow LED	Yellow LED
Precautions			
• Spurious signal suppression		•	•
• Short-circuit-proof/overload-proof		•	–
• Reverse-polarity protection		•	•
• Wire-break protection		•	•
• Inductive interference protection		•	•
• Radio interference protection		•	•
Degree of protection		IP67	IP67

#### Selection and Ordering data

Switching output	Circuit diagram number <sup>1)</sup>	Connector type <sup>2)</sup>	Order No.	Order No.
<b>With 2 m cable, PUR</b>			3 × 0.25 mm <sup>2</sup>	2 × 0.25 mm <sup>2</sup>
NO contact, pnp	11	B	<b>3RG40 24-0AB00</b>	–
NC contact, pnp	12	B	<b>3RG40 24-0AA00</b>	–
NO contact	16	–	–	▶ B <b>3RG40 24-0KB00</b>
NC contact	17	–	–	▶ B <b>3RG40 24-0KA00</b>
<b>With M12 connector</b>				
NO contact, pnp	2	E, F	▶ B <b>3RG40 24-3AB00</b>	–
NC contact, pnp	3	F	B <b>3RG40 24-3AA00</b>	–
NO contact	8	E, F	–	▶ B <b>3RG40 24-3KB00</b>
NC contact	9	F	–	B <b>3RG40 24-3KA00</b>

1) See page 2/242.

2) See from page 2/268.

▶ Preferred type, available from stock.

B: Subject to export regulations AL = N and ECCN = EAR99.

#### Dimensions

##### Mounting instructions

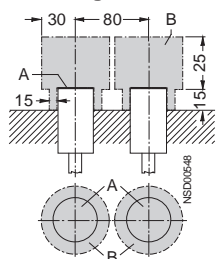
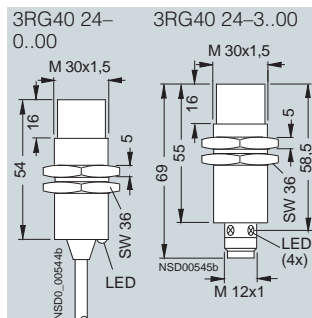
A = active surface  
B = metal-free area

### Technical specifications

Class		Extra duty (65 V DC)	Extra duty (AC/DC)
Number of wires		3-wire	2-wire
Design		Cubic 40 mm x 40 mm	Cubic 40 mm x 40 mm
Installation in metal		Flush	Flush
Rated operating distance $s_n$		15 mm	15 mm
Enclosure material		Molded plastic	Molded plastic
Operating voltage			
• DC	V	10 ... 65	20 ... 320
• AC	V	–	20 ... 265
No-load supply current $I_0$			
• At 24 V DC	mA	≤ 20	1.0
• At 230 V AC	mA	–	1.5
Rated operational current $I_e$			
• Continuous	mA	300	300
• 20 ms	mA	–	1800
Minimum load current	mA	–	5
Switching frequency $f$	Hz	100	25/150 (AC/DC)
Repeat accuracy $R$	mm	0.75	0.75
Power-up delay $t_v$	ms	100	100
LEDs			
• Switching status		Yellow LED	Yellow LED
• Supply voltage		Green LED	–
Precautions			
• Spurious signal suppression		•	•
• Short-circuit-proof/overload-proof		•	–
• Reverse-polarity protection		•	•
• Wire-break protection		•	•
• Inductive interference protection		•	•
• Radio interference protection		•	•
Degree of protection		IP65	IP65

### Selection and Ordering data

Switching output	Circuit diagram number <sup>1)</sup>	Order No.	Order No.
<b>With terminal box</b>		0.5 ... 2.5 mm <sup>2</sup>	0.5 ... 2.5 mm <sup>2</sup>
NO contact or NC contact repositionable, prnp	23	▶ B <b>3RG40 31-6AD00</b>	–
NO contact or NC contact repositionable	24	–	▶ B <b>3RG40 31-6KD00</b>

1) See page 2/242.

▶ Preferred type, available from stock.

B: Subject to export regulations AL = N and ECCN = EAR99.

### Dimensions

#### Mounting instructions

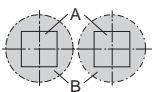
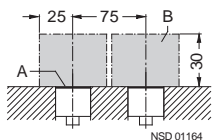

A = active surface  
B = metal-free area

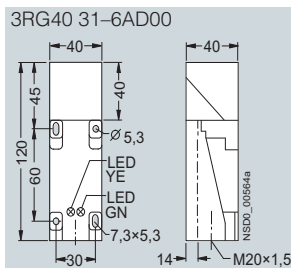

The active surface can be adjusted in 5 directions.

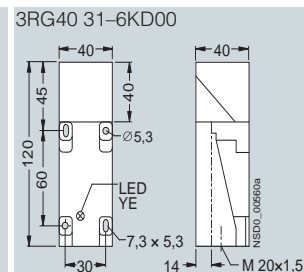

The active surface can be adjusted in 5 directions.

# SIMATIC PXI inductive proximity switches

## SIMATIC PXI300

Operating distance 15 mm

### Technical specifications

Class	Extra duty (AC/DC)		Increased operating distance
Number of wires	2-wire		3-wire
Design	Cubic 40 mm x 40 mm		M30
Installation in metal	Flush		Flush
Rated operating distance $s_n$	15 mm		15 mm
Enclosure material	Molded plastic		Brass, nickel-plated
Operating voltage			
• DC	V	20 ... 320	15 ... 34
• AC	V	20 ... 265	–
No-load supply current $I_0$			
• At 24 V DC	mA	1.5	≤ 17 (24 V); ≤ 30 (34 V)
• At 230 V AC	mA	≤ 2.0	–
Rated operational current $I_e$			
• Continuous	mA	300	200 (≤ 50 °C); 150 (≤ 85 °C)
• 20 ms	mA	–	–
Minimum load current	mA	≤ 2	–
Switching frequency $f$	Hz	25/50 (AC/DC)	300
Repeat accuracy $R$	mm	0.75	0.4
Hysteresis	mm	0.04 ... 3.3	–
Power-up delay $t_v$	ms	100	40
Switching status display		Yellow LED	Yellow LED
Precautions			
• Spurious signal suppression	•	–	•
• Short-circuit-proof/overload-proof	–	–	•
• Reverse-polarity protection	•	–	•
• Wire-break protection	–	–	•
• Inductive interference protection	•	–	•
• Radio interference protection	•	–	•
Degree of protection		IP67	IP67

### Selection and Ordering data

Switching output	Circuit diagram number <sup>1)</sup>	Connector type <sup>2)</sup>	Order No.	Order No.
<b>With 3 m cable, PUR</b>				
NO contact, pnp	11	–	–	3 × 0.25 mm <sup>2</sup> B <b>3RG41 14-0AG01</b>
<b>With M12 connector</b>				
NO contact, pnp	2	E, F	–	B <b>3RG41 14-3AG01</b>
<b>With M12 connector, rotatable</b>				
NO contact	8	E, F	B <b>3RG40 38-3KB00</b>	–

1) See page 2/242.

2) See from page 2/268.

B: Subject to export regulations AL = N and ECCN = EAR99.

### Dimensions

#### Mounting instructions

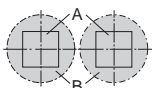
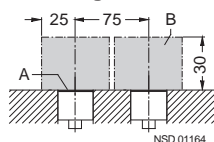

A = active surface  
B = metal-free area

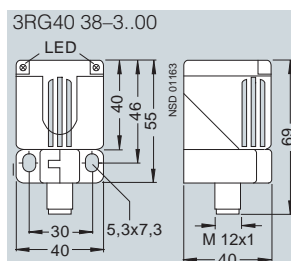

The active surface can be adjusted in 5 directions.  
With rotatable connector..

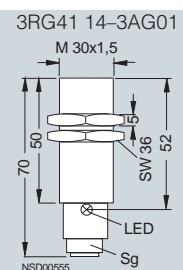
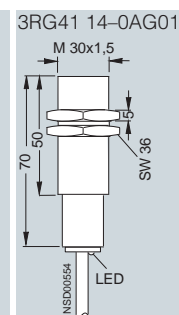

## Technical specifications

Class	IP68 / 69 K	IP68 / 69 K	IP68 / 69 K
Number of wires	3-wire	3-wire	3-wire
Design	Ø 30 mm	M30	M30
Installation in metal	Not flush	Not flush	Not flush
Rated operating distance $s_n$	15 mm	15 mm	15 mm
Enclosure material	Molded plastic	Molded plastic	Brass, nickel-plated
Operating voltage (DC)	V 15 ... 34	15 ... 34	15 ... 34
No-load supply current $I_0$	mA $\leq 17$ (24 V); $\leq 30$ (34 V)	$\leq 17$ (24 V); $\leq 30$ (34 V)	$\leq 17$ (24 V); $\leq 30$ (34 V)
Rated operational current $I_e$	mA 200 ( $\leq 50$ °C); 150 ( $\leq 85$ °C)	200 ( $\leq 50$ °C); 150 ( $\leq 85$ °C)	200 ( $\leq 50$ °C); 150 ( $\leq 85$ °C)
Switching frequency $f$	Hz 300	300	300
Repeat accuracy $R$	mm 0.4	0.4	0.4
Power-up delay $t_v$	ms 40	40	40
Switching status display	Yellow LED	Yellow LED	Yellow LED
Precautions	<ul style="list-style-type: none"> <li>• Spurious signal suppression</li> <li>• Short-circuit-proof/overload-proof</li> <li>• Reverse-polarity protection</li> <li>• Wire-break protection</li> <li>• Inductive interference protection</li> <li>• Radio interference protection</li> </ul>	<ul style="list-style-type: none"> <li>•</li> <li>•</li> <li>•</li> <li>•</li> <li>•</li> <li>•</li> </ul>	<ul style="list-style-type: none"> <li>•</li> <li>•</li> <li>•</li> <li>•</li> <li>•</li> <li>•</li> </ul>
Degree of protection	IP68 / 69 K	IP68 / 69 K	IP68 / 69 K

## Selection and Ordering data

Switching output	Circuit diagram number <sup>1)</sup>	Connector type <sup>2)</sup>	Order No.	Order No.	Order No.
<b>With 2 m cable</b>			PUR, 3 × 0.25 mm <sup>2</sup>	PUR, 3 × 0.25 mm <sup>2</sup>	PVC, 3 × 0.25 mm <sup>2</sup>
NO contact, pnp	11	B	<b>3RG40 64-0AG30</b>	B <b>3RG40 24-0AG30</b>	B <b>3RG40 24-0AG31</b>
NC contact, pnp	12	B	<b>3RG40 64-0AF30</b>	B <b>3RG40 24-0AF30</b>	—
NO contact, npn	13	B	<b>3RG40 64-0GB30</b>	B <b>3RG40 24-0GB30</b>	B <b>3RG40 24-0GB31</b>
NC contact, npn	14	B	<b>3RG40 64-0GA30</b>	B <b>3RG40 24-0GA30</b>	—
<b>With M12 connector</b>			—	B <b>3RG40 24-3AG30</b>	B <b>3RG40 24-3AG31</b>
NO contact, pnp	8	E, F	—	B <b>3RG40 24-3AF30</b>	—
NC contact, pnp	9	F	—	—	—

1) See page 2/242.

2) See from page 2/268.

B: Subject to export regulations AL = N and ECCN = EAR99.

## Dimensions

## Mounting instructions

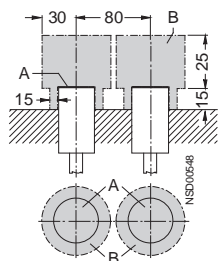
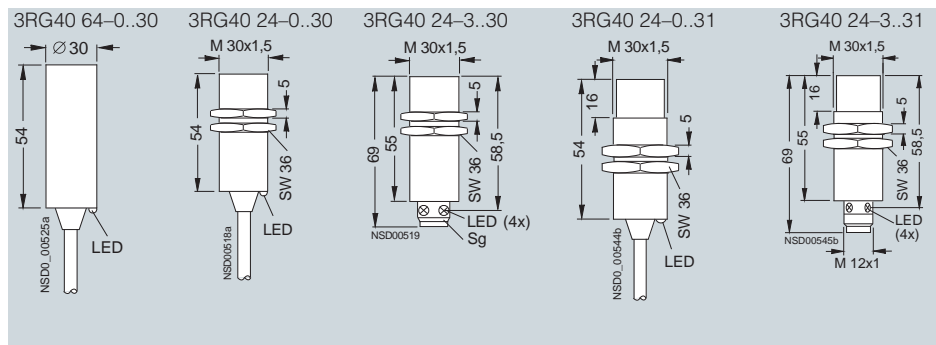
A = active surface  
B = metal-free area

# SIMATIC PXI inductive proximity switches

## SIMATIC PXI300

Operating distance 15 mm

### Technical specifications

Class	IP68 / 69 K (DC 65 V)		IP68 / 69 K (AC/DC)
Number of wires	3-wire		2-wire
Design	M30		M30
Installation in metal	Not flush		Not flush
Rated operating distance $s_n$	15 mm		15 mm
Enclosure material	Molded plastic		Molded plastic
Operating voltage			
• DC	V	10 ... 65	20 ... 320
• AC	V	–	20 ... 265
No-load supply current $I_0$			
• At 24 V DC	mA	≤ 10	1.0
• At 230 V AC	mA	–	1.5
Rated operational current $I_e$			
• Continuous	mA	300	300
• 20 ms	mA	–	1800
Minimum load current	mA	–	5
Switching frequency $f$	Hz	300	25/220 (AC/DC)
Repeat accuracy $R$	mm	0.4	0.4
Power-up delay $t_v$	ms	40	100
Switching status display	Yellow LED		Yellow LED
Precautions			
• Spurious signal suppression	•		•
• Short-circuit-proof/overload-proof	•		–
• Reverse-polarity protection	•		•
• Wire-break protection	•		•
• Inductive interference protection	•		•
• Radio interference protection	•		•
Degree of protection	IP68 / 69 K		IP68 / 69 K

### Selection and Ordering data

Switching output	Circuit diagram number <sup>1)</sup>	Connector type <sup>2)</sup>	Order No.	Order No.
<b>With 2 m cable, PUR</b>			3 × 0.25 mm <sup>2</sup>	2 × 0.25 mm <sup>2</sup>
NO contact, pnp	11	B	<b>3RG40 24-0AB30</b>	–
NC contact, pnp	12	B	<b>3RG40 24-0AA30</b>	–
NO contact	16	–	–	▶ B <b>3RG40 24-0KB30</b>
NC contact	17	–	–	B <b>3RG40 24-0KA30</b>
<b>With M12 connector</b>				
NO contact, pnp	2	E, F	B <b>3RG40 24-3AB30</b>	–
NC contact, pnp	3	F	B <b>3RG40 24-3AA30</b>	–
NO contact	8	E, F	–	B <b>3RG40 24-3KB30</b>
NC contact	9	F	–	B <b>3RG40 24-3KA30</b>

1) See page 2/242.

2) See from page 2/268.

▶ Preferred type, available from stock.

B: Subject to export regulations AL = N and ECCN = EAR99.

### Dimensions

#### Mounting instructions

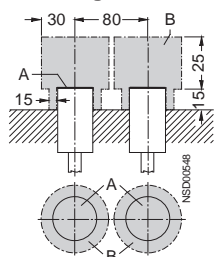

A = active surface  
B = metal-free area

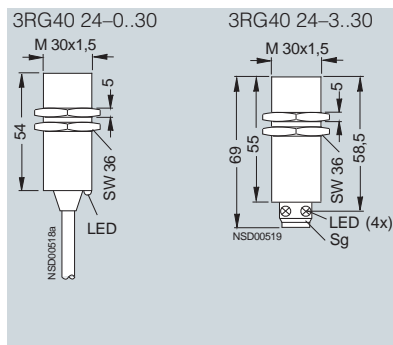

## Technical specifications

Class	IP68 / 69 K	IP68 / 69 K (65 V DC)	IP68 / 69 K (AC/DC)
Number of wires	4-wire	3-wire	2-wire
Design	Cubic 40 mm x 40 mm	Cubic 40 mm x 40 mm	Cubic 40 mm x 40 mm
Installation in metal	Flush	Flush	Flush
Rated operating distance $s_n$	15 mm	15 mm	15 mm
Enclosure material	Molded plastic	Molded plastic	Molded plastic
Operating voltage			
• DC	V 15 ... 34	10 ... 65	20 ... 320
• AC	V –	–	20 ... 265
No-load supply current $I_0$			
• At 24 V DC	mA $\leq 25$ (24 V); $\leq 40$ (34 V)	$\leq 20$	$\leq 1.0$
• At 230 V AC	mA –	–	$\leq 1.5$
Rated operational current $I_e$			
• Continuous	mA 200 ( $\leq 50$ °C); 150 ( $\leq 85$ °C)	300	300
• 20 ms	mA –	–	1800
Minimum load current	mA –	–	5
Switching frequency $f$	Hz 100	100	25/150 (AC/DC)
Repeat accuracy $R$	mm 0.75	0.75	0.75
Power-up delay $t_v$	ms 100	100	100
Switching status display	Yellow LED	Yellow LED	Yellow LED
Precautions			
• Spurious signal suppression	•	•	•
• Short-circuit-proof/overload-proof	•	•	–
• Reverse-polarity protection	•	•	•
• Wire-break protection	•	•	•
• Inductive interference protection	•	•	•
• Radio interference protection	•	•	•
Degree of protection	IP68 / 69 K	IP68 / 69 K	IP68 / 69 K

## Selection and Ordering data

Switching output	Circuit diagram number <sup>1)</sup>	Order No.	Order No.	Order No.
<b>With 2 m cable, PUR</b>		4 x 0.14 mm <sup>2</sup>	3 x 0.25 mm <sup>2</sup>	2 x 0.25 mm <sup>2</sup>
<b>Sensor in longitudinal axis</b>				
NO contact, pnp	11	–	B 3RG40 30–0AB00	–
NC contact, pnp	12	–	B 3RG40 30–0AA00	–
NO contact and NC contact, pnp	10	B 3RG40 30–0CD00	–	–
NO contact	16	–	–	B 3RG40 30–0KB00
NC contact	17	–	–	B 3RG40 30–0KA00
<b>Sensor 90° to longitudinal axis</b>				
NO contact, pnp	11	–	B 3RG40 30–0AB01	–
NO contact and NC contact, pnp	10	B 3RG40 30–0CD01	–	–
NO contact	16	–	–	B 3RG40 30–0KB01
NC contact	17	–	–	B 3RG40 30–0KA01

1) See page 2/242.

B: Subject to export regulations AL = N and ECCN = EAR99.

## Dimensions

## Mounting instructions

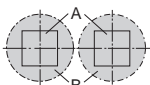
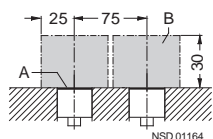
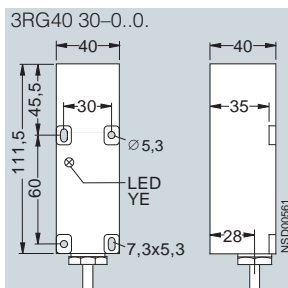
A = active surface  
B = metal-free area



# SIMATIC PXI inductive proximity switches

## SIMATIC PXI300

### Operating distance 20 mm

#### Technical specifications

Class		Extra duty (65 V DC)	Extra duty (AC/DC)
Number of wires		3-wire	2-wire
Design		Cubic 40 mm x 40 mm	Cubic 40 mm x 40 mm
Installation in metal		Not flush	Not flush
Rated operating distance $s_n$		20 mm	20 mm
Enclosure material		Molded plastic	Molded plastic
Operating voltage			
• DC	V	10 ... 65	20 ... 320
• AC	V	–	20 ... 265
No-load supply current $I_0$			
• At 24 V DC	mA	≤ 20	1.0
• At 230 V AC	mA	–	1.5
Rated operational current $I_e$			
• Continuous	mA	300	300
• 20 ms	mA	–	1800
Minimum load current	mA	–	5
Switching frequency $f$	Hz	75	25/100 (AC/DC)
Repeat accuracy $R$	mm	0.75	1.0
Power-up delay $t_v$	ms	100	20
LEDs			
• Switching status		Yellow LED	Yellow LED
• Supply voltage		Green LED	–
Precautions			
• Spurious signal suppression		•	•
• Short-circuit-proof/overload-proof		•	–
• Reverse-polarity protection		•	•
• Wire-break protection		•	•
• Inductive interference protection		•	•
• Radio interference protection		•	•
Degree of protection		IP65	IP65

#### Selection and Ordering data

Switching output	Circuit diagram number <sup>1)</sup>	Order No.	Order No.
<b>With terminal box</b>		0.5 ... 2.5 mm <sup>2</sup>	0.5 ... 2.5 mm <sup>2</sup>
NO contact or NC contact repositionable, prnp	23	▶ B <b>3RG40 41-6AD00</b>	–
NO contact or NC contact repositionable	24	–	▶ B <b>3RG40 41-6KD00</b>

1) See page 2/242.

▶ Preferred type, available from stock.

B: Subject to export regulations AL = N and ECCN = EAR99.

#### Dimensions

##### Mounting instructions

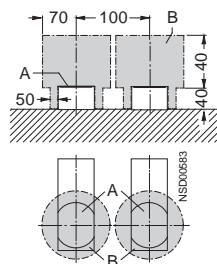

A = active surface;  
B = metal-free area

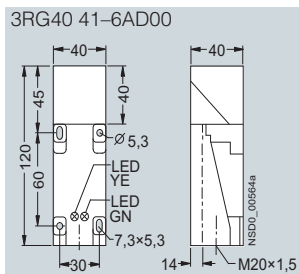

The active surface can be adjusted in 5 directions.

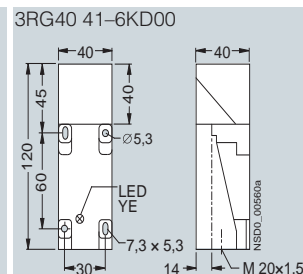

The active surface can be adjusted in 5 directions.

# SIMATIC PXI inductive proximity switches

## SIMATIC PXI300

Operating distance 20 mm

2

### Technical specifications

Class	Increased operating distance	
Number of wires	3-wire	4-wire
Design	M18	Cubic 40 mm × 40 mm
Installation in metal	Not flush	Flush
Rated operating distance $s_n$	20 mm	20 mm
Enclosure material	Brass, nickel-plated	Molded plastic
Operational voltage (DC)	V	15 ... 34
No-load supply current $I_0$	mA	≤ 30 (24 V); ≤ 50 (34 V)
Rated operational current $I_e$	mA	200 (≤ 50 °C); 150 (≤ 85 °C)
Switching frequency $f$	Hz	200
Repeat accuracy $R$	mm	1.0
Power-up delay $t_v$	ms	100
LEDs		
• Switching status	Yellow LED	Yellow LED
• Supply voltage	–	Green LED
Precautions		
• Spurious signal suppression	•	•
• Short-circuit-proof/overload-proof	•	•
• Reverse-polarity protection	•	•
• Wire-break protection	•	•
• Inductive interference protection	•	•
• Radio interference protection	•	•
Degree of protection	IP67	IP65

### Selection and Ordering data

Switching output	Circuit diagram number <sup>1)</sup>	Connector type <sup>2)</sup>	Order No.	Order No.
<b>With 2 m cable, PUR</b>			3 × 0.34 mm <sup>2</sup>	
NO contact, pnp	11	▶	<b>3RG46 23-0AB02</b>	–
NO contact, npn	13		<b>3RG46 23-0GB02</b>	–
<b>With M12 connector</b>				
NO contact, pnp	2	E, F ▶	<b>3RG46 23-3AB02</b>	–
NO contact, npn	4	E, F	<b>3RG46 23-3GB02</b>	–
<b>With terminal box</b>			0.5 ... 2.5 mm <sup>2</sup>	
NO contact and NC contact, pnp	18	–	–	<b>B 3RG41 34-6CD01</b>

- 1) See page 2/242.
- 2) See from page 2/268.
- ▶ Preferred type, available from stock.
- B: Subject to export regulations AL = N and ECCN = EAR99.

### Dimensions

#### Mounting instructions

3RG46 23

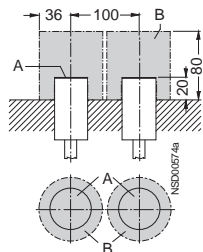

3RG41 34

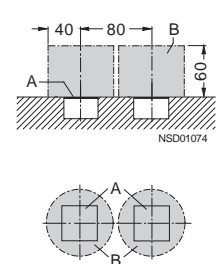

3RG46 23-0..02

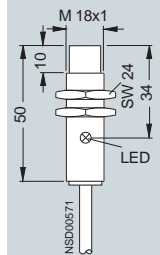

3RG46 23-3..02

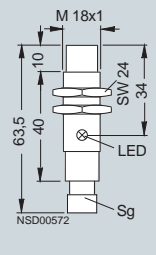

3RG41 34-6CD01

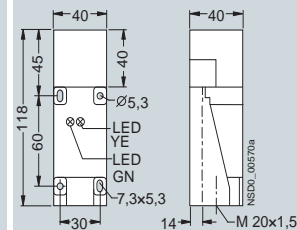

The active surface can be adjusted in 5 directions. With screwed sensor.

A = active surface  
B = metal-free area

# SIMATIC PXI inductive proximity switches

## SIMATIC PXI300

### Operating distance 20 mm

#### Technical specifications

Class	Increased operating distance		Increased operating distance (AC/DC)	
Number of wires	4-wire		2-wire	
Design	Cubic 40 mm x 40 mm		Cubic 40 mm x 40 mm	
Installation in metal	Flush		Flush	
Rated operating distance $s_n$	20 mm		20 mm	
Enclosure material	Molded plastic		Molded plastic	
Operating voltage				
• DC	V	15 ... 34	20 ... 320	
• AC	V	–	20 ... 265	
No-load supply current $I_0$				
• At 24 V DC	mA	≤ 30 (24 V); ≤ 40 (34 V)	1.5	
• At 230 V AC	mA	–	≤ 2.0	
Rated operational current $I_e$				
• Continuous	mA	200 (≤ 50 °C); 150 (≤ 85 °C)	200	
• 20 ms	mA	–	–	
Minimum load current	mA	–	< 2	
Switching frequency $f$	Hz	30	25/30 (AC/DC)	
Repeat accuracy $R$	mm	0.75	0.75	
Hysteresis $H$	mm	0.05 ... 3.3	0.05 ... 3.3	
Power-up delay $t_v$	ms	100	100	
LEDs				
• Switching status	Yellow LED		Yellow LED	
• Supply voltage	Green LED		–	
Precautions				
• Spurious signal suppression	•		•	
• Short-circuit-proof/overload-proof	•		–	
• Reverse-polarity protection	•		•	
• Wire-break protection	•		–	
• Inductive interference protection	•		•	
• Radio interference protection	•		•	
Degree of protection	IP67		IP67	

#### Selection and Ordering data

Switching output	Circuit diagram number <sup>1)</sup>	Connector type <sup>2)</sup>	Order No.	Order No.
<b>With M12 connector</b>				
NO contact and NC contact, pnp	1	F	▶ B <b>3RG41 38-3CD00</b>	–
NO contact and NC contact, npn	–	F	B <b>3RG41 38-3GD00</b>	–
NO contact	8	F	–	B <b>3RG41 38-3KB00</b>

1) See page 2/242.

2) See from page 2/268.

▶ Preferred type, available from stock.

B: Subject to export regulations AL = N and ECCN = EAR99.

#### Dimensions

##### Mounting instructions

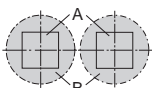
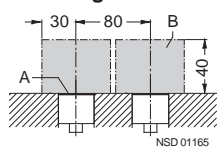

A = active surface  
B = metal-free area

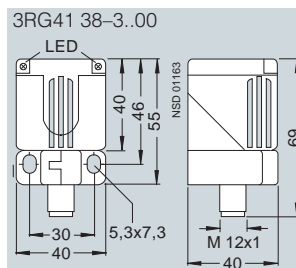

The active surface can be adjusted in 5 directions.  
With rotatable connector.

### Technical specifications

<b>Class</b>	<b>Increased operating distance</b>	
<b>Number of wires</b>	<b>3-wire</b>	
<b>Design</b>	<b>M30</b>	
<b>Installation in metal</b>	<b>Almost flush</b>	
<b>Rated operating distance <math>s_n</math></b>	<b>22 mm</b>	
Enclosure material	Brass, nickel-plated	
Operational voltage (DC)	V	10 ... 30
No-load supply current $I_0$	mA	≤ 10
Rated operational current $I_e$	mA	200
Switching frequency $f$	Hz	100
Repeat accuracy $R$	mm	1.1
Power-up delay $t_v$	ms	200
LEDs	<ul style="list-style-type: none"> <li>• Switching status</li> <li>• Supply voltage</li> </ul>	
Precautions	<ul style="list-style-type: none"> <li>• Spurious signal suppression</li> <li>• Short-circuit-proof/overload-proof</li> <li>• Reverse-polarity protection</li> <li>• Wire-break protection</li> <li>• Inductive interference protection</li> <li>• Radio interference protection</li> </ul>	
Degree of protection	IP67	

### Selection and Ordering data

Switching output	Circuit diagram number <sup>1)</sup>	Connector type <sup>2)</sup>	Order No.
<b>With 2 m cable, PUR</b>			$3 \times 0.34 \text{ mm}^2$
NO contact, pnp	11	▶	<b>3RG46 14-0AB00</b>
NO contact, npn	13	▶	<b>3RG46 14-0GB00</b>
<b>With M12 connector</b>			
NO contact, pnp	2	E, F ▶	<b>3RG46 14-3AB00</b>
NO contact, npn	4	E, F ▶	<b>3RG46 14-3GB00</b>

1) See page 2/242.

2) See from page 2/268.

▶ Preferred type, available from stock.

### Dimensions

#### Mounting instructions

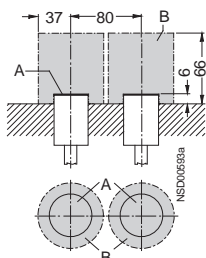

A = active surface  
B = metal-free area

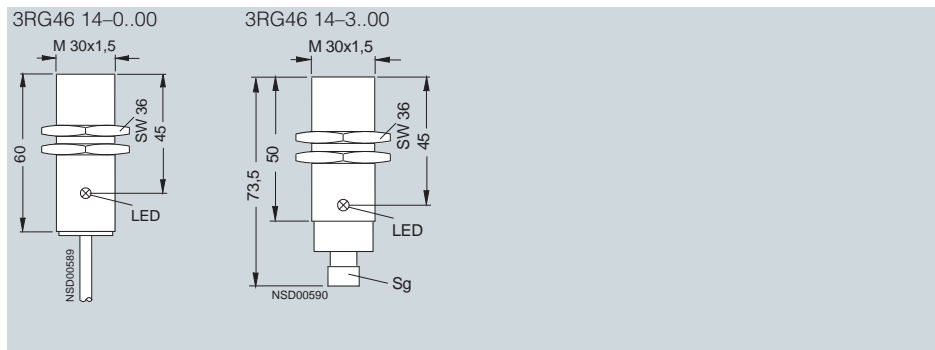

# SIMATIC PXI inductive proximity switches

## SIMATIC PXI300

Operating distance 25 mm

### Technical specifications

<b>Class</b>	<b>Increased operating distance (65 V DC)</b>	
<b>Number of wires</b>	<b>3-wire</b>	
<b>Design</b>	<b>Cubic 40 mm x 40 mm</b>	
<b>Installation in metal</b>	<b>Almost flush</b>	
<b>Rated operating distance <math>s_n</math></b>	<b>25 mm</b>	
Enclosure material	Molded plastic	
Operating voltage (DC)	V	10 ... 65
No-load supply current $I_0$	mA	20
Rated operational current $I_e$	mA	300
Switching frequency $f$	Hz	50
Repeat accuracy $R$	mm	1.5
Power-up delay $t_v$	ms	100
<b>LEDs</b>		
• Switching status	Yellow LED	
• Supply voltage	Green LED	
<b>Precautions</b>		
• Spurious signal suppression	•	
• Short-circuit-proof/overload-proof	•	
• Reverse-polarity protection	•	
• Wire-break protection	•	
• Inductive interference protection	•	
• Radio interference protection	•	
Degree of protection	IP65	

### Selection and Ordering data

Switching output	Circuit diagram number <sup>1)</sup>	Order No.
<b>With terminal box</b>		0.5 ... 2.5 mm <sup>2</sup>
NO contact or NC contact repositionable, prnp	23	▶ B <b>3RG41 31-6AD00</b>

1) See page 2/242.

▶ Preferred type, available from stock.

B: Subject to export regulations AL = N and ECCN = EAR99.

### Dimensions

#### Mounting instructions

3RG41 31

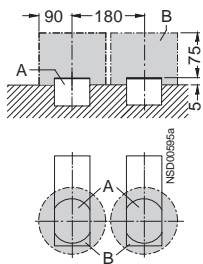

A = active surface  
B = metal-free area

3RG41 31-6AD0.

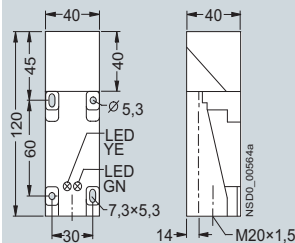

The active surface can be adjusted in 5 directions.

### Technical specifications

Class	Extra duty (65 V DC)		Extra duty (AC/DC)	
Number of wires	3-wire		2-wire	
Design	Cubic 60 mm x 80 mm		Cubic 60 mm x 80 mm	
Installation in metal	Not flush		Not flush	
Rated operating distance $s_n$	30 mm		30 mm	
Enclosure material	Molded plastic		Molded plastic	
Operating voltage				
• DC	V	10 ... 65		20 ... 320
• AC	V	–		20 ... 265
No-load supply current $I_0$				
• At 24 V DC	mA	≤ 40		1.0
• At 230 V AC	mA	–		1.5
Rated operational current $I_e$				
• Continuous	mA	300		300
• 20 ms	mA	–		1800
Minimum load current	mA	–		5
Switching frequency $f$	Hz	50		25/60 (AC/DC)
Repeat accuracy $R$	mm	1.0		1.0
Power-up delay $t_v$	ms	100		100
LEDs				
• Switching status		Yellow LED		Yellow LED
• Supply voltage		Green LED		–
Precautions				
• Spurious signal suppression		•		•
• Short-circuit-proof/overload-proof		•		–
• Reverse-polarity protection		•		•
• Wire-break protection		•		•
• Inductive interference protection		•		•
• Radio interference protection		•		•
Degree of protection		IP65		IP65

### Selection and Ordering data

Switching output	Circuit diagram number <sup>1)</sup>	Order No.	Order No.
<b>With terminal box</b>		0.5 ... 2.5 mm <sup>2</sup>	0.5 ... 2.5 mm <sup>2</sup>
NO contact or NC contact repositionable, prnp	23	▶ B <b>3RG40 42-6AD00</b>	–
NO contact or NC contact repositionable	24	–	▶ B <b>3RG40 42-6KD00</b>

1) See page 2/242.

▶ Preferred type, available from stock.

B: Subject to export regulations AL = N and ECCN = EAR99.

### Dimensions

#### Mounting instructions

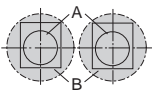
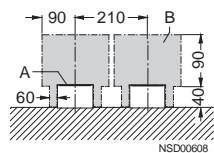

A = active surface  
B = metal-free area

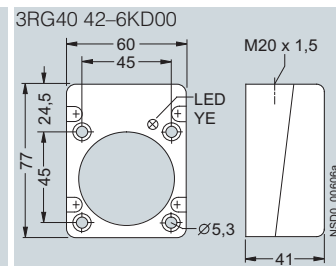
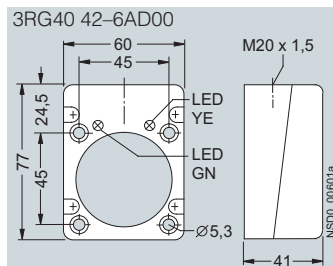

# SIMATIC PXI inductive proximity switches

## SIMATIC PXI300

Operating distance 30 mm

### Technical specifications

<b>Class</b>	<b>Increased operating distance</b>	
<b>Number of wires</b>	<b>4-wire</b>	
<b>Design</b>	<b>Cubic 40 mm x 40 mm</b>	
<b>Installation in metal</b>	<b>Not flush</b>	
<b>Rated operating distance <math>s_n</math></b>	<b>30 mm</b>	
Enclosure material	Molded plastic	
Operating voltage	V	15 ... 34
No-load supply current $I_0$	mA	$\leq 30$ (24 V); $\leq 50$ (34 V)
Rated operational current $I_e$	mA	200 ( $\leq 50$ °C); 150 ( $\leq 85$ °C)
Switching frequency $f$	Hz	30
Repeat accuracy $R$	mm	1.5
Power-up delay $t_v$	ms	100
<b>LEDs</b>		
• Switching status	Yellow LED	
• Supply voltage	Green LED	
<b>Precautions</b>		
• Spurious signal suppression	•	
• Short-circuit-proof/overload-proof	•	
• Reverse-polarity protection	•	
• Wire-break protection	•	
• Inductive interference protection	•	
• Radio interference protection	•	
Degree of protection	IP65	

### Selection and Ordering data

Switching output	Circuit diagram number <sup>1)</sup>	Order No.
<b>With terminal box</b>		0.5 ... 2.5 mm <sup>2</sup>
NO contact and NC contact, pnp	18	<b>3RG41 44-6CD01</b>

1) See page 2/242.

### Dimensions

#### Mounting instructions

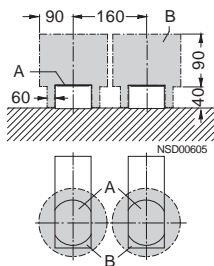

A = active surface  
B = metal-free area

#### 3RG41 44-6CD01

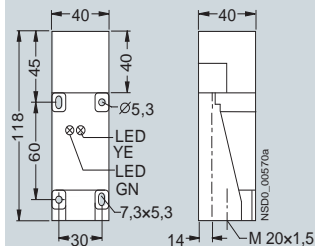

The active surface can be adjusted in 5 directions.  
With screwed sensor.

### Technical specifications

Class		Increased operating distance		Increased operating distance (AC/DC)	
Number of wires		4-wire		2-wire	
Design		Cubic 40 mm x 40 mm		Cubic 40 mm x 40 mm	
Installation in metal		Not flush		Not flush	
Rated operating distance $s_n$		35 mm		35 mm	
Enclosure material		Molded plastic		Molded plastic	
Operating voltage $U_B$					
• DC	V	15 ... 34		20 ... 320	
• AC	V	–		20 ... 265	
No-load supply current $I_0$					
• At 24 V DC	mA	≤ 30 (24 V); ≤ 40 (34 V)		1.5	
• At $U_{B \max}$	mA	–		≤ 2.0	
Rated operational current $I_e$					
• Continuous	mA	200 (≤ 50 °C); 150 (≤ 85 °C)		300	
• 20 ms	mA	–		–	
Minimum load current		mA		–	
		–		< 2	
Switching frequency $f$		Hz		30	
Repeat accuracy $R$		mm		0.75	
Hysteresis $H$		mm		0.05 ... 7.7	
Power-up delay $t_v$		ms		100	
LEDs					
• Switching status		Yellow LED		Yellow LED	
• Supply voltage		Green LED		–	
Precautions					
• Spurious signal suppression		•		•	
• Short-circuit-proof/overload-proof		•		–	
• Reverse-polarity protection		•		–	
• Wire-break protection		•		–	
• Inductive interference protection		•		•	
• Radio interference protection		•		•	
Degree of protection		IP67		IP67	

### Selection and Ordering data

Switching output	Circuit diagram number <sup>1)</sup>	Connector type <sup>2)</sup>	Order No.	Order No.
<b>With M12 connector</b>				
NO contact and NC contact, pnp	1	F	▶ B 3RG41 48-3CD00	–
NO contact and NC contact, npn	–	F	B 3RG41 48-3GD00	–
NO contact	8	F	–	B 3RG41 48-3KB00

1) See page 2/242.

2) See from page 2/268.

▶ Preferred type, available from stock.

B: Subject to export regulations AL = N and ECCN = EAR99.

### Dimensions

#### Mounting instructions

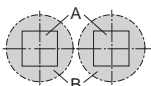
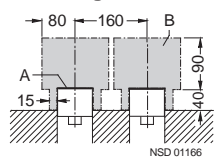

A = active surface  
B = metal-free area

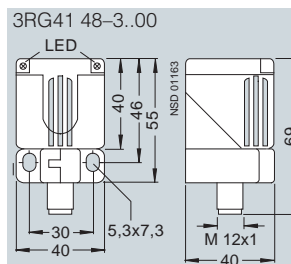

The active surface can be adjusted in 5 directions.  
With rotatable connector.



# SIMATIC PXI inductive proximity switches

## SIMATIC PXI300

### Operating distance 40 mm

#### Technical specifications

Class		Extra duty (65 V DC)	Extra duty (AC/DC)
Number of wires		3-wire	2-wire
Design		Cubic 80 mm x 100 mm	Cubic 80 mm x 100 mm
Installation in metal		Not flush	Not flush
Rated operating distance $s_n$		40 mm	40 mm
Enclosure material		Molded plastic	Molded plastic
Operating voltage $U_B$			
• DC	V	10 ... 65	20 ... 320
• AC	V	–	20 ... 265
No-load supply current $I_0$			
• At 24 V DC	mA	≤ 40	1.0
• At 230 V AC	mA	–	1.5
Rated operational current $I_e$			
• Continuous	mA	300	300
• 20 ms	mA	–	1800
Minimum load current	mA	–	5
Switching frequency	Hz	10	25/60 (AC/DC)
Repeat accuracy $R$	mm	1.0	1.0
Power-up delay $t_v$	ms	200	100
LEDs			
• Switching status		Yellow LED	Yellow LED
• Supply voltage		Green LED	–
Precautions			
• Spurious signal suppression	•	•	•
• Short-circuit-proof/overload-proof	•	•	•
• Reverse-polarity protection	•	•	•
• Wire-break protection	•	•	•
• Inductive interference protection	•	•	•
• Radio interference protection	•	•	•
Degree of protection		IP65	IP65

#### Selection and Ordering data

Switching output	Circuit diagram number <sup>1)</sup>	Order No.	Order No.
<b>With terminal box</b>		0.5 ... 2.5 mm <sup>2</sup>	0.5 ... 2.5 mm <sup>2</sup>
NO contact or NC contact repositionable, npn	23	▶ B <b>3RG40 43-6AD00</b>	–
NO contact or NC contact repositionable	24	–	▶ B <b>3RG40 43-6KD00</b>

1) See page 2/242.

▶ Preferred type, available from stock.

B: Subject to export regulations AL = N and ECCN = EAR99.

#### Dimensions

##### Mounting instructions

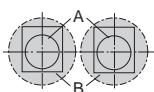
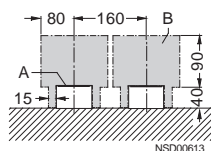

A = active surface  
B = metal-free area

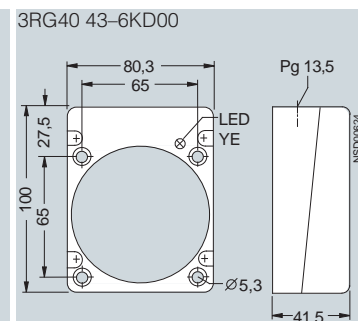
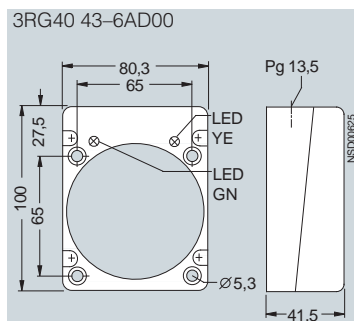

### Technical specifications

Class	Extra duty (65 V DC)		Extra duty (AC/DC)	
Number of wires	3-wire		2-wire	
Design	Cubic 80 mm × 100 mm		Cubic 80 mm × 100 mm	
Installation in metal	Not flush / flush		Not flush / flush	
Rated operating distance $s_n$	30 mm / 40 mm		30 mm / 40 mm	
Enclosure material	Molded plastic		Molded plastic	
Operating voltage $U_B$				
• DC	V	10 ... 65		20 ... 320
• AC	V	–		20 ... 265
No-load supply current $I_0$				
• At 24 V DC	mA	≤ 40		1.0
• At $U_{max}$	mA	–		1.5
Rated operational current $I_e$				
• Continuous	mA	300		300
• 20 ms	mA	–		1800
Minimum load current	mA	–		5
Switching frequency $f$	Hz	10		25/60 (AC/DC)
Repeat accuracy $R$	mm	2		2
Power-up delay $t_v$	ms	200		100
LEDs				
• Switching status		Yellow LED		Yellow LED
• Supply voltage		Green LED		–
Precautions				
• Spurious signal suppression	•			•
• Short-circuit-proof/overload-proof	•			–
• Reverse-polarity protection	•			•
• Wire-break protection	•			•
• Inductive interference protection	•			•
• Radio interference protection	•			•
Degree of protection		IP65		IP65

### Selection and Ordering data

Switching output	Circuit diagram number <sup>1)</sup>	Order No.	Order No.
<b>With terminal box</b>		0.5 ... 2.5 mm <sup>2</sup>	0.5 ... 2.5 mm <sup>2</sup>
NO contact or NC contact repositionable, pnp	23	▶ B <b>3RG40 33-6AD01</b>	–
NO contact or NC contact repositionable	24	–	B <b>3RG40 33-6KD01</b>

1) See page 2/242. ▶ Preferred type, available from stock.  
 B: Subject to export regulations AL = N and ECCN = EAR99.

### Dimensions

#### Mounting instructions

Rated operating distance 30 mm

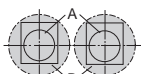
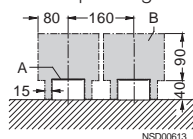

Rated operating distance 40 mm

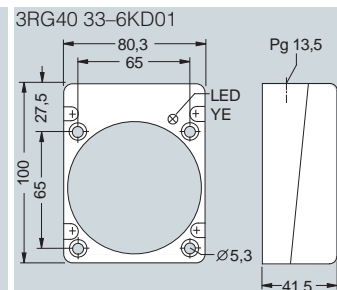
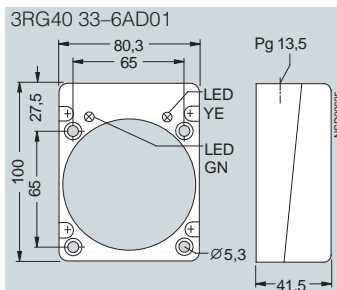
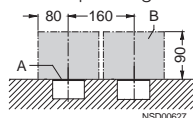

A = active surface  
 B = metal-free area

# SIMATIC PXI inductive proximity switches

## SIMATIC PXI300

Operating distance 40 mm

### Technical specifications

<b>Class</b>	<b>Increased operating distance</b>	
<b>Number of wires</b>	<b>3-wire</b>	
<b>Design</b>	<b>M30</b>	
<b>Installation in metal</b>	<b>Not flush</b>	
<b>Rated operating distance <math>s_n</math></b>	<b>40 mm</b>	
Enclosure material	Brass, nickel-plated	
Operating voltage $U_B$	V	10 ... 30
No-load supply current $I_0$	mA	≤ 10
Rated operational current $I_e$	mA	200
Switching frequency $f$	Hz	100
Repeat accuracy $R$	mm	1.1
Power-up delay $t_v$	ms	200
<b>LEDs</b>		
• Switching status	Yellow LED	
• Supply voltage	–	
<b>Precautions</b>		
• Spurious signal suppression	•	
• Short-circuit-proof/overload-proof	•	
• Reverse-polarity protection	•	
• Wire-break protection	•	
• Inductive interference protection	•	
• Radio interference protection	•	
Degree of protection	IP67 (not suitable for use under continuous wet conditions or outdoors)	

### Selection and Ordering data

Switching output	Circuit diagram number <sup>1)</sup>	Connector type <sup>2)</sup>	Order No.
<b>With 2 m cable, PUR</b>			$3 \times 0.34 \text{ mm}^2$
NO contact, pnp	11	▶	<b>3RG46 24-0AB02</b>
NO contact, npn	13		<b>3RG46 24-0GB02</b>
<b>With M12 connector</b>			
NO contact, pnp	2	E, F ▶	<b>3RG46 24-3AB02</b>
NO contact, npn	4	E, F	<b>3RG46 24-3GB02</b>

1) See page 2/242.

2) See from page 2/268.

▶ Preferred type, available from stock.

### Dimensions

#### Mounting instructions

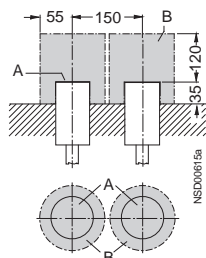

A = active surface  
B = metal-free area

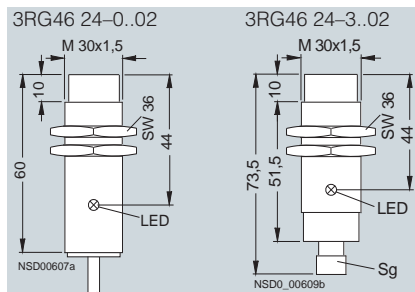

### Technical specifications

<b>Class</b>	<b>Increased operating distance (65 V DC)</b>	
<b>Number of wires</b>	<b>3-wire</b>	
<b>Design</b>	<b>Cubic 40 mm x 40 mm</b>	
<b>Installation in metal</b>	<b>Not flush</b>	
<b>Rated operating distance <math>s_n</math></b>	<b>40 mm</b>	
Enclosure material	Molded plastic	
Operational voltage (DC)	V	10 ... 65
No-load supply current $I_0$	mA	20
Rated operational current $I_e$	mA	300
Switching frequency $f$	Hz	20
Repeat accuracy $R$	mm	1.5
Power-up delay $t_v$	ms	100
LEDs		
• Switching status	Yellow LED	
• Supply voltage	Green LED	
Precautions		
• Spurious signal suppression	•	
• Short-circuit-proof/overload-proof	•	
• Reverse-polarity protection	•	
• Wire-break protection	•	
• Inductive interference protection	•	
• Radio interference protection	•	
Degree of protection	IP65	

### Selection and Ordering data

Switching output	Circuit diagram number <sup>1)</sup>	Order No.
<b>With terminal box</b>		0.5 ... 2.5 mm <sup>2</sup>
NO contact, pnp	19	B <b>3RG41 41-6AB03</b>
NO contact or NC contact repositionable, pnp	23	B <b>3RG41 41-6AD00</b>

1) See page 2/242.

B: Subject to export regulations AL = N and ECCN = EAR99.

### Dimensions

#### Mounting instructions

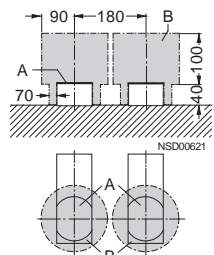

A = active surface  
B = metal-free area

3RG41 41-6A.0.

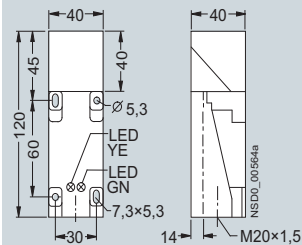

The active surface can be adjusted in 5 directions.

# SIMATIC PXI inductive proximity switches

## SIMATIC PXI300

Operating distance 25 mm or 40 mm

### Technical specifications

<b>Class</b>	<b>Increased operating distance (65 V DC)</b>	
<b>Number of wires</b>	<b>3-wire</b>	
<b>Design</b>	<b>Cubic 40 mm x 40 mm</b>	
<b>Installation in metal</b>	<b>Not flush</b>	
<b>Rated operating distance <math>s_n</math></b>	<b>25 mm or 40 mm, selectable</b>	
Enclosure material	Molded plastic	
Operational voltage (DC)	V	10 ... 65
No-load supply current $I_0$	mA	20
Rated operational current $I_e$	mA	300
Switching frequency $f$	Hz	20
Repeat accuracy $R$	mm	1.5
Power-up delay $t_v$	ms	100
LEDs		
• Switching status	Yellow LED	
• Supply voltage	Green LED	
Precautions		
• Spurious signal suppression	•	
• Short-circuit-proof/overload-proof	•	
• Reverse-polarity protection	•	
• Wire-break protection	•	
• Inductive interference protection	•	
• Radio interference protection	•	
Degree of protection	IP67	

### Selection and Ordering data

Switching output	Circuit diagram number <sup>1)</sup>	Connector type <sup>2)</sup>	Order No.
<b>With M12 connector</b>			
NO contact, pnp	2	E, F	B <b>3RG41 41-3AB02</b>
<i>Connector can be offset in steps of 30°</i>			
NO contact, pnp	2	E, F	B <b>3RG41 41-3AB01</b>

1) See page 2/242.

2) See from page 2/268.

B: Subject to export regulations AL = N and ECCN = EAR99.

### Dimensions

#### Mounting instructions

Rated operating distance 25 mm

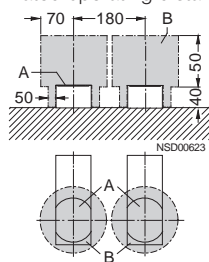

Rated operating distance 40 mm

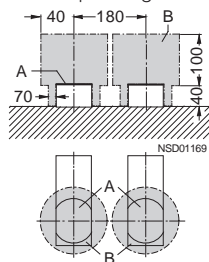

A = active surface

B = metal-free area

3RG41 41-3AB02

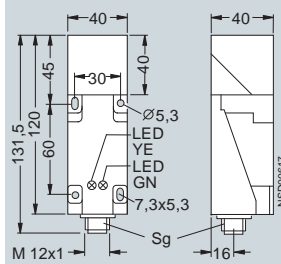

The active surface can be adjusted in 5 directions.

3RG41 41-3AB01

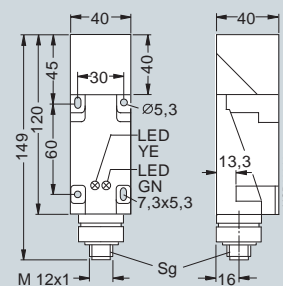

The active surface can be adjusted in 5 directions.

### Technical specifications

Class	Increased operating distance (65 V DC)	
<b>Number of wires</b>	3-wire	3-wire
<b>Design</b>	Cubic 60 mm x 80 mm	Cubic 80 mm x 100 mm
<b>Installation in metal</b>	Not flush	Not flush
<b>Rated operating distance <math>s_n</math></b>	50 mm	65 mm
Enclosure material	Molded plastic	Molded plastic
Operational voltage (DC)	V 10 ... 65	10 ... 65
No-load supply current $I_0$	mA 20	20
Rated operational current $I_e$	mA 300	300
Switching frequency $f$	Hz 20	10
Repeat accuracy $R$	mm 1.5	2
Power-up delay $t_v$	ms 100	100
<b>LEDs</b>		
• Switching status	Yellow LED	Yellow LED
• Operating voltage	Green LED	Green LED
<b>Precautions</b>		
• Spurious signal suppression	•	•
• Short-circuit-proof/overload-proof	•	•
• Reverse-polarity protection	•	•
• Wire-break protection	•	•
• Inductive interference protection	•	•
• Radio interference protection	•	•
Degree of protection	IP65	IP65

### Selection and Ordering data

Switching output	Circuit diagram number <sup>1)</sup>	Order No.	Order No.
<b>With terminal box</b>		0.5 ... 2.5 mm <sup>2</sup>	0.5 ... 2.5 mm <sup>2</sup>
NO contact or NC contact repositionable, prnp	23	B <b>3RG41 42-6AD00</b>	B <b>3RG41 43-6AD00</b>

1) See page 2/242.

B: Subject to export regulations AL = N and ECCN = EAR99.

### Dimensions

#### Mounting instructions

3RG41 42

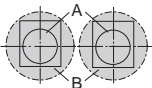
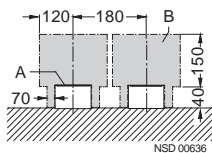

3RG41 43

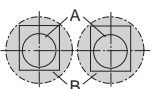
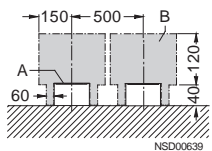

A = active surface  
B = metal-free area

3RG41 42-6AD00

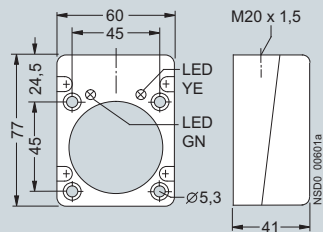

3RG41 43-6AD00

