

**Inductive proximity switch**

**IFRM 18P17A3/L**

**dimension drawing**

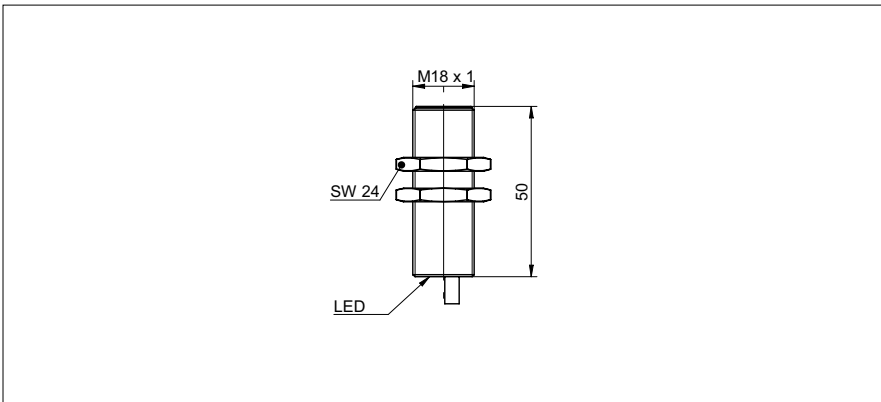

**general data**

mounting type	quasi-flush
nominal sensing distance $S_n$	8 mm
hysteresis	3 ... 20 % of $S_r$
output indicator	LED red

**electrical data**

switching frequency	< 500 Hz
voltage supply range +Vs	10 ... 30 VDC
current consumption max. (no load)	10 mA
output circuit	PNP make function (NO)
voltage drop $V_d$	< 2 VDC
output current	< 200 mA
short circuit protection	yes
reverse polarity protection	yes

**mechanical data**

type	cylindrical threaded
material (sensing face)	PBT
housing material	brass nickel plated
dimension	18 mm
housing length	50 mm
connection types	cable, 2 m
tightening torque max.	40 Nm

**ambient conditions**

operating temperature	-25 ... +75 °C
protection class	IP 67

**photo**



**connection diagram**



• Not for flush mounting in mild steel